

FEATURES

Complete 8-Bit DAC
Voltage Output—2 Calibrated Ranges
Internal Precision Bandgap Reference
Single-Supply Operation: +5 V to +15 V
Full Microprocessor Interface
Fast: 1 μ s Voltage Settling to $\pm 1/2$ LSB
Low Power: 75 mW
No User Trims
Guaranteed Monotonic Over Temperature
All Errors Specified T_{MIN} to T_{MAX}
Small 16-Pin DIP and 20-Pin PLCC Packages
Single Laser-Wafer-Trimmed Chip for Hybrids
Low Cost
MIL-STD-883 Compliant Versions Available

PRODUCT DESCRIPTION

The AD558 DACPORT[®] is a complete voltage-output 8-bit digital-to-analog converter, including output amplifier, full microprocessor interface and precision voltage reference on a single monolithic chip. No external components or trims are required to interface, with full accuracy, an 8-bit data bus to an analog system.

The performance and versatility of the DACPORT is a result of several recently-developed monolithic bipolar technologies. The complete microprocessor interface and control logic is implemented with integrated injection logic (I^2L), an extremely dense and low power logic structure that is process-compatible with linear bipolar fabrication. The internal precision voltage reference is the patented low voltage bandgap circuit which permits full-accuracy performance on a single +5 V to +15 V power supply. Thin-film silicon-chromium resistors provide the stability required for guaranteed monotonic operation over the entire operating temperature range (all grades), while recent advances in laser-wafer-trimming of these thin-film resistors permit absolute calibration at the factory to within ± 1 LSB; thus no user-trims for gain or offset are required. A new circuit design provides voltage settling to $\pm 1/2$ LSB for a full-scale step in 800 ns.

The AD558 is available in four performance grades. The AD558J and K are specified for use over the 0°C to +70°C temperature range, while the AD558S and T grades are specified for -55°C to +125°C operation. The "J" and "K" grades are available either in 16-pin plastic (N) or hermetic ceramic (D) DIPs. They are also available in 20-pin JEDEC standard PLCC packages. The "S" and "T" grades are available in the 16-pin hermetic ceramic DIP package.

DACPORT is a registered trademark of Analog Devices, Inc.

REV. B

FUNCTIONAL BLOCK DIAGRAM



PRODUCT HIGHLIGHTS

1. The 8-bit I^2L input register and fully microprocessor-compatible control logic allow the AD558 to be directly connected to 8- or 16-bit data buses and operated with standard control signals. The latch may be disabled for direct DAC interfacing.
2. The laser-trimmed on-chip SiCr thin-film resistors are calibrated for absolute accuracy and linearity at the factory. Therefore, no user trims are necessary for full rated accuracy over the operating temperature range.
3. The inclusion of a precision low voltage bandgap reference eliminates the need to specify and apply a separate reference source.
4. The voltage switching structure of the AD558 DAC section along with a high speed output amplifier and laser trimmed resistors give the user a choice of 0 V to +2.56 V or 0 V to +10 V output ranges, selectable by pin-strapping. Circuitry is internally compensated for minimum settling time on both ranges; typically settling to $\pm 1/2$ LSB for a full-scale 2.55 volt step in 800 ns.
5. The AD558 is designed and specified to operate from a single +4.5 V to +16.5 V power supply.
6. Low digital input currents, 100 μ A max, minimize bus loading. Input thresholds are TTL/low voltage CMOS compatible over the entire operating V_{CC} range.
7. All AD558 grades are available in chip form with guaranteed specifications from +25°C to T_{MAX} . MIL-STD-883, Class B visual inspection is standard on Analog Devices bipolar chips. Contact the factory for additional chip information.
8. The AD558 is available in versions compliant with MIL-STD-883. Refer to Analog Devices Military Products Data-book or current AD558/883B data sheet for detailed specifications.

Rev. B

[Document Feedback](#)

Information furnished by Analog Devices is believed to be accurate and reliable. However, no responsibility is assumed by Analog Devices for its use, nor for any infringements of patents or other rights of third parties that may result from its use. Specifications subject to change without notice. No license is granted by implication or otherwise under any patent or patent rights of Analog Devices. Trademarks and registered trademarks are the property of their respective owners.

AD558—SPECIFICATIONS (@ $T_A = +25^\circ\text{C}$, $V_{CC} = +5\text{ V to } +15\text{ V}$ unless otherwise noted)

Model	AD558J			AD558K			AD558S ¹			AD558T ¹			Units
	Min	Typ	Max	Min	Typ	Max	Min	Typ	Max	Min	Typ	Max	
RESOLUTION	8			8			8			8			Bits
RELATIVE ACCURACY ²													
0°C to +70°C	±1/2			±1/4			±1/2			±1/4			LSB
-55°C to +125°C							±3/4			±3/8			LSB
OUTPUT Ranges ³	0 to +2.56 0 to +10			0 to +2.56 0 to +10			0 to +2.56 0 to +10			0 to +2.56 0 to +10			V V mA
Current Source Sink	+5 Internal Passive Pull-Down to Ground ⁴			+5 Internal Passive Pull-Down to Ground			+5 Internal Passive Pull-Down to Ground			+5 Internal Passive Pull-Down to Ground			
OUTPUT SETTLING TIME ⁵													
0 to 2.56 Volt Range	0.8 1.5			0.8 1.5			0.8 1.5			0.8 1.5			µs
0 to 10 Volt Range ⁴	2.0 3.0			2.0 3.0			2.0 3.0			2.0 3.0			µs
FULL-SCALE ACCURACY ⁶													
@ 25°C	±1.5			±0.5			±1.5			±0.5			LSB
T_{MIN} to T_{MAX}	±2.5			±1			±2.5			±1			LSB
ZERO ERROR													
@ 25°C	±1			±1/2			±1			±1/2			LSB
T_{MIN} to T_{MAX}	±2			±1			±2			±1			LSB
MONOTONICITY ⁷													
T_{MIN} to T_{MAX}	Guaranteed			Guaranteed			Guaranteed			Guaranteed			
DIGITAL INPUTS													
T_{MIN} to T_{MAX}													
Input Current	±100			±100			±100			100			µA
Data Inputs, Voltage													
Bit On-Logic "1"	2.0			2.0			2.0			2.0			V
Bit On-Logic "0"	0 0.8			0			0			0			V
Control Inputs, Voltage													
On-Logic "1"	2.0			2.0			2.0			2.0			V
On-Logic "0"	0 0.8			0 0.8			0 0.8			0 0.8			V
Input Capacitance	4			4			4			4			pF
TIMING ⁸													
t_{WS} Strobe Pulse Width	200			200			200			200			ns
T_{MIN} to T_{MAX}	270			270			270			270			ns
t_{DH} Data Hold Time	10			10			10			10			ns
T_{MIN} to T_{MAX}	10			10			10			10			ns
t_{DS} Data Set-Up Time	200			200			200			200			ns
T_{MIN} to T_{MAX}	270			270			270			270			ns
POWER SUPPLY													
Operating Voltage Range (V_{CC})													
2.56 Volt Range	+4.5 +16.5			+4.5 +16.5			+4.5 +16.5			+4.5 +16.5			V
10 Volt Range	+11.4 +16.5			+11.4 +16.5			+11.4 +16.5			+11.4 +16.5			V
Current (I_{CC})	15 25			15 25			15 25			15 25			mA
Rejection Ratio	0.03			0.03			0.03			0.03			%%
POWER DISSIPATION, $V_{CC} = 5\text{ V}$	75 125			75 125			75 125			75 125			mW
$V_{CC} = 15\text{ V}$	225 375			225 375			225 375			225 375			mW
OPERATING TEMPERATURE RANGE	0 +70			0 +70			-55 +125			-55 +125			°C

NOTES

¹The AD558 S & T grades are available processed and screened to MIL-STD-883 Class B. Consult Analog Devices' Military Databook for details.

²Relative Accuracy is defined as the deviation of the code transition points from the ideal transfer point on a straight line from the offset to the full scale of the device. See "Measuring Offset Error".

³Operation of the 0 volt to 10 volt output range requires a minimum supply voltage of +11.4 volts.

⁴Passive pull-down resistance is 2 kΩ for 2.56 volt range, 10 kΩ for 10 volt range.

⁵Settling time is specified for a positive-going full-scale step to ±1/2 LSB. Negative-going steps to zero are slower, but can be improved with an external pull-down.

⁶The full range output voltage for the 2.56 range is 2.55 V and is guaranteed with a +5 V supply, for the 10 V range, it is 9.960 V guaranteed with a +15 V supply.

⁷A monotonic converter has a maximum differential linearity error of ±1 LSB.

⁸See Figure 7.

Specifications shown in **boldface** are tested on all production units at final electrical test.

Specifications subject to change without notice.

ABSOLUTE MAXIMUM RATINGS*

V_{CC} to Ground	0 V to +18 V
Digital Inputs (Pins 1–10)	0 V to +7.0 V
V_{OUT}	Indefinite Short to Ground Momentary Short to V_{CC}
Power Dissipation	450 mW
Storage Temperature Range	
N/P (Plastic) Packages	–25°C to +100°C
D (Ceramic) Package	–55°C to +150°C
Lead Temperature (soldering, 10 sec)	+300°C
Thermal Resistance	
Junction to Ambient/Junction to Case	
D (Ceramic) Package	100°C/W/30°C/W
N/P (Plastic) Packages	140°C/W/55°C/W

*Stresses greater than those listed under “Absolute Maximum Ratings” may cause permanent damage to the device. This is a stress rating only and functional operation of the device at these or any other conditions above those indicated in the operational section of this specification is not implied. Exposure to absolute maximum rating conditions for extended periods may affect device reliability.

AD558 METALIZATION PHOTOGRAPH

Dimensions shown in inches and (mm).



Bond Pad Coordinates

Pad No.	Pad Name	X Coordinate	Y Coordinate
1	DB0	–702	1265
2	DB1	–927	1265
3	DB2	–957	1004
4	DB3	–957	347
5	DB4	–957	115
6	DB5	–957	–111
7	DB6	–927	–1248
8	DB7	–702	–1248
9	\overline{CE}	47	–1248
10	\overline{CS}	272	–1248
11	V_{CC}	957	–1225
12	GND	957	–965
13	GND	946	970
14	$V_{OUT}SELECT$	923	1265
15	$V_{OUT}SENSE$	689	1265
16	V_{OUT}	–461	1265



Figure 1a. AD558 Pin Configuration (DIP)



Figure 1b. AD558 Pin Configuration (PLCC and LCC)

AD558

CIRCUIT DESCRIPTION

The AD558 consists of four major functional blocks, fabricated on a single monolithic chip (see Figure 2). The main D-to-A converter section uses eight equally-weighted laser-trimmed current sources switched into a silicon-chromium thin-film R/2R resistor ladder network to give a direct but unbuffered 0 mV to 400 mV output range. The transistors that form the DAC switches are PNPs; this allows direct positive-voltage logic interface and a zero-based output range.



Figure 2. AD558 Functional Block Diagram

The high speed output buffer amplifier is operated in the non-inverting mode with gain determined by the user-connections at the output range select pin. The gain-setting application resistors are thin-film laser-trimmed to match and track the DAC resistors and to assure precise initial calibration of the two output ranges, 0 V to 2.56 V and 0 V to 10 V. The amplifier output stage is an NPN transistor with passive pull-down for zero-based output capability with a single power supply. The internal precision voltage reference is of the patented bandgap type. This design produces a reference voltage of 1.2 volts and thus, unlike 6.3 volt temperature compensated Zeners, may be operated from a single, low voltage logic power supply. The microprocessor interface logic consists of an 8-bit data latch and control circuitry. Low power, small geometry and high speed are advantages of the I²L design as applied to this section. I²L is bipolar process compatible so that the performance of the analog sections need not be compromised to provide on-chip logic capabilities. The control logic allows the latches to be operated from a decoded microprocessor address and write signal. If the application does not involve a μ P or data bus, wiring CS and CE to ground renders the latches “transparent” for direct DAC access.

MIL-STD-883

The rigors of the military/aerospace environment, temperature extremes, humidity, mechanical stress, etc., demand the utmost in electronic circuits. The AD558, with the inherent reliability of integrated circuit construction, was designed with these applications in mind. The hermetically-sealed, low profile DIP package takes up a fraction of the space required by equivalent modular designs and protects the chip from hazardous environments. To further ensure reliability, military temperature range AD558 grades S and T are available screened to MIL-STD-883. For more complete data sheet information consult the Analog Devices’ Military Databook.

CHIP AVAILABILITY

The AD558 is available in laser-trimmed, passivated chip form. AD558J and AD558T chips are available. Consult the factory for details.

Input Logic Coding

Digital Input Code			Output Voltage	
Binary	Hexadecimal	Decimal	2.56 V Range	10.000 V Range
0000 0000	00	0	0	0
0000 0001	01	1	0.010 V	0.039 V
0000 0010	02	2	0.020 V	0.078 V
0000 1111	0F	15	0.150 V	0.586 V
0001 0000	10	16	0.160 V	0.625 V
0111 1111	7F	127	1.270 V	4.961 V
1000 0000	80	128	1.280 V	5.000 V
1100 0000	C0	192	1.920 V	7.500 V
1111 1111	FF	255	2.55 V	9.961 V

CONNECTING THE AD558

The AD558 has been configured for ease of application. All reference, output amplifier and logic connections are made internally. In addition, all calibration trims are performed at the factory assuring specified accuracy without user trims. The only connection decision that must be made by the user is a single jumper to select output voltage range. Clean circuit board layout is facilitated by isolating all digital bit inputs on one side of the package; analog outputs are on the opposite side.

Figure 3 shows the two alternative output range connections. The 0 V to 2.56 V range may be selected for use with any power supply between +4.5 V and +16.5 V. The 0 V to 10 V range requires a power supply of +11.4 V to +16.5 V.



a. 0 V to 2.56 V Output Range b. 0 V to 10 V Output Range
Figure 3. Connection Diagrams

Because of its precise factory calibration, the AD558 is intended to be operated without user trims for gain and offset; therefore no provisions have been made for such user trims. If a small increase in scale is required, however, it may be accomplished by slightly altering the effective gain of the output buffer. A resistor in series with V_{OUT} SENSE will increase the output range.

For example if a 0 V to 10.24 V output range is desired (40 mV = 1 LSB), a nominal resistance of 850 Ω is required. It must be remembered that, although the internal resistors all ratio-match and track, the *absolute* tolerance of these resistors is typically $\pm 20\%$ and the *absolute* TC is typically -50 ppm/ $^{\circ}$ C (0 to -100 ppm/ $^{\circ}$ C). That must be considered when rescaling is performed. Figure 4 shows the recommended circuitry for a full-scale output range of 10.24 volts. Internal resistance values shown are nominal.



Figure 4. 10.24 V Full-Scale Connection

NOTE: Decreasing the scale by putting a resistor in series with GND will not work properly due to the code-dependent currents in GND. Adjusting offset by injecting dc at GND is not recommended for the same reason.

GROUNDING AND BYPASSING*

All precision converter products require careful application of good grounding practices to maintain full rated performance. Because the AD558 is intended for application in microcomputer systems where digital noise is prevalent, special care must be taken to assure that its inherent precision is realized.

The AD558 has two ground (common) pins; this minimizes ground drops and noise in the analog signal path. Figure 5 shows how the ground connections should be made.



Figure 5. Recommended Grounding and Bypassing

It is often advisable to maintain separate analog and digital grounds throughout a complete system, tying them common in one place only. If the common tie-point is remote and accidental disconnection of that one common tie-point occurs due to card removal with power on, a large differential voltage between the two commons could develop. To protect devices that interface to both digital and analog parts of the system, such as the AD558, it is recommended that common ground tie-points should be provided at each such device. If only one system ground can be connected directly to the AD558, it is recommended that analog common be selected.

POWER SUPPLY CONSIDERATIONS

The AD558 is designed to operate from a single positive power supply voltage. Specified performance is achieved for any supply voltage between +4.5 V and +16.5 V. This makes the AD558 ideal for battery-operated, portable, automotive or digital main-frame applications.

*For additional insight, "An IC Amplifier Users' Guide to Decoupling, Grounding and Making Things Go Right For A change," is available at no charge from any Analog Devices Sales Office.

The only consideration in selecting a supply voltage is that, in order to be able to use the 0 V to 10 V output range, the power supply voltage must be between +11.4 V and +16.5 V. If, however, the 0 V to 2.56 V range is to be used, power consumption will be minimized by utilizing the lowest available supply voltage (above +4.5 V).

TIMING AND CONTROL

The AD558 has data input latches that simplify interface to 8- and 16-bit data buses. These latches are controlled by Chip Enable (\overline{CE}) and Chip Select (\overline{CS}) inputs. \overline{CE} and \overline{CS} are internally "NORed" so that the latches transmit input data to the DAC section when both \overline{CE} and \overline{CS} are at Logic "0". If the application does not involve a data bus, a "00" condition allows for direct operation of the DAC. When either \overline{CE} or \overline{CS} go to Logic "1", the input data is latched into the registers and held until both \overline{CE} and \overline{CS} return to "0". (Unused \overline{CE} or \overline{CS} inputs should be tied to ground.) The truth table is given in Table I. The logic function is also shown in Figure 6.

Table I. AD558 Control Logic Truth Table

Input Data	\overline{CE}	\overline{CS}	DAC Data	Latch Condition
0	0	0	0	"Transparent"
1	0	0	1	"Transparent"
0	g	0	0	Latching
1	g	0	1	Latching
0	0	g	0	Latching
1	0	g	1	Latching
X	1	X	Previous Data	Latched
X	X	1	Previous Data	Latched

NOTES

X = Does not matter.

g = Logic Threshold at Positive-Going Transition.

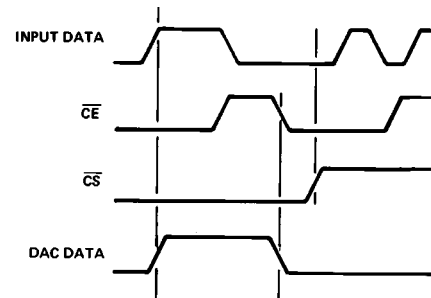

Figure 6. AD558 Control Logic Function

In a level-triggered latch such as that in the AD558 there is an interaction between data setup and hold times and the width of the enable pulse. In an effort to reduce the time required to test all possible combinations in production, the AD558 is tested with $t_{DS} = t_W = 200$ ns at 25°C and 270 ns at T_{MIN} and T_{MAX} , with $t_{DH} = 10$ ns at all temperatures. Failure to comply with these specifications may result in data not being latched properly.

Figure 7 shows the timing for the data and control signals; \overline{CE} and \overline{CS} are identical in timing as well as in function.

AD558



Figure 7. AD558 Timing

USE OF $V_{OUT\ SENSE}$

Separate access to the feedback resistor of the output amplifier allows additional application versatility. Figure 8a shows how $I \times R$ drops in long lines to remote loads may be cancelled by putting the drops “inside the loop.” Figure 8b shows how the separate sense may be used to provide a higher output current by feeding back around a simple current booster.

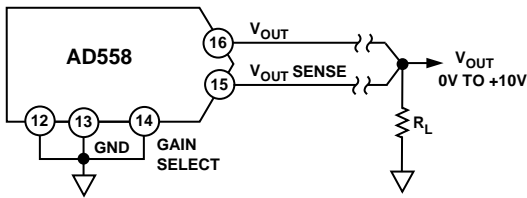

a. Compensation for $I \times R$ Drops in Output Lines

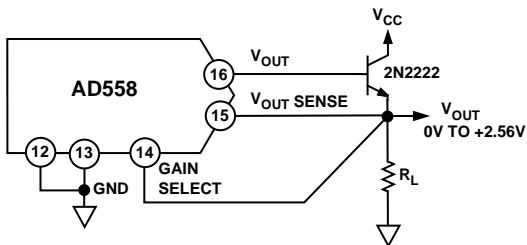

b. Output Current Booster
Figure 8. Use of $V_{OUT\ SENSE}$

OPTIMIZING SETTLE TIME

In order to provide single-supply operation and zero-based output voltage ranges, the AD558 output stage has a passive “pull-down” to ground. As a result, settling time for negative-going output steps may be longer than for positive-going output steps. The relative difference depends on load resistance and capacitance. If a negative power supply is available, the negative-going settling time may be improved by adding a pull-down resistor from the output to the negative supply as shown in Figure 9. The value of the resistor should be such that, at zero voltage out, current through that resistor is 0.5 mA max.

BIPOLAR OUTPUT RANGES

The AD558 was designed for operation from a single power supply and is thus capable of providing only unipolar (0 V to +2.56 V and 0 V to 10 V) output ranges. If a negative supply is



Figure 9. Improved Settling Time

available, bipolar output ranges may be achieved by suitable output offsetting and scaling. Figure 10 shows how a ± 1.28 volt output range may be achieved when a -5 volt power supply is available. The offset is provided by the AD589 precision 1.2 volt reference which will operate from a $+5$ volt supply. The AD544 output amplifier can provide the necessary ± 1.28 volt output swing from ± 5 volt supplies. Coding is complementary offset binary.



Figure 10. Bipolar Operation of AD558 from ± 5 V Supplies

MEASURING OFFSET ERROR

One of the most commonly specified endpoint errors associated with real-world nonideal DACs is offset error.

In most DAC testing, the offset error is measured by applying the zero-scale code and measuring the output deviation from 0 volts. There are some DACs, like the AD558 where offset errors may be present but not observable at the zero scale, because of other circuit limitations (such as zero coinciding with single-supply ground) so that a nonzero output at zero code cannot be read as the offset error. Factors like this make testing the AD558 a little more complicated.

By adding a pull-down resistor from the output to a negative supply as shown in Figure 11, we can now read offset errors at zero code that may not have been observable due to circuit limitations. The value of the resistor should be such that, at zero voltage out, current through the resistor is 0.5 mA max.



a. 0 V to 2.56 V Output Range



b. 0 V to 10 V Output Range
Figure 11. Offset Connection Diagrams

INTERFACING THE AD558 TO MICROPROCESSOR DATA BUSES

The AD558 is configured to act like a “write only” location in memory that may be made to coincide with a read only memory location or with a RAM location. The latter case allows data previously written into the DAC to be read back later via the RAM. Address decoding is partially complete for either ROM or RAM. Figure 12 shows interfaces for three popular microprocessor systems.



b. 8080A/AD558 Interface



c. 1802/AD558 Interface

Figure 12. Interfacing the AD558 to Microprocessors



a. 6800/AD558 Interface

Performance (typical @ +25°C, V_{CC} ± +5 V to +15 V unless otherwise noted)



Figure 13. Full-Scale Accuracy vs. Temperature Performance of AD558



Figure 14. Zero Drift vs. Temperature Performance of AD558

AD558

OUTLINE DIMENSIONS



Figure 15. Quiescent Current vs. Power Supply Voltage for AD558

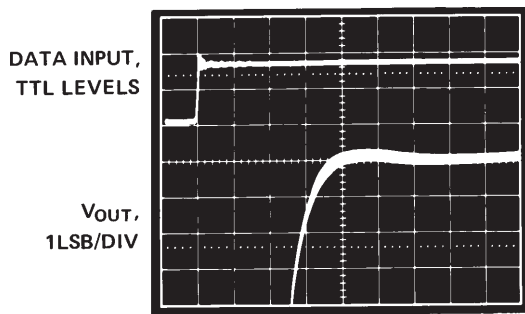

HORIZONTAL: 200ns/DIV

Figure 16. AD558 Settling Characteristics Detail 0 V to 2.56 V Output Range Full-Scale Step



HORIZONTAL: 500ns/DIV

Figure 17. AD558 Settling Characteristic Detail 0 V to 10 V Output Range Full-Scale Step



HORIZONTAL: 100ns/DIV

Figure 18. AD558 Logic Timing

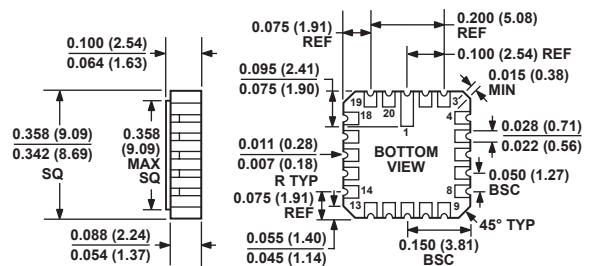
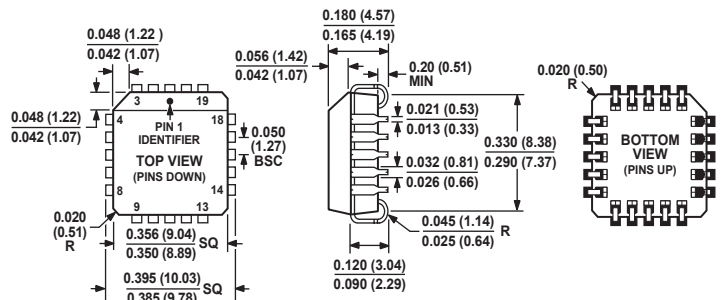
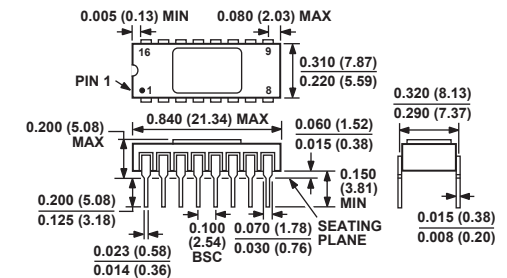
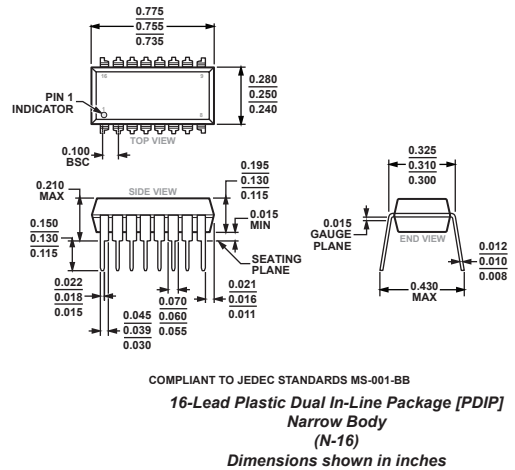

ORDERING GUIDE

Model	Temperature Range	Relative Accuracy Error Max	Full Scale Error Max	Package Option
		T _{MIN} to T _{MAX}	T _{MIN} to T _{MAX}	
AD558JN	0°C to +70°C	±1/2 LSB	±2.5 LSB	PDIP (N-16)
AD558JNZ	0°C to +70°C	±1/2 LSB	±2.5 LSB	PDIP (N-16)
AD558JP	0°C to +70°C	±1/2 LSB	±2.5 LSB	PLCC (P-20)
AD558JP-REEL7	0°C to +70°C	±1/2 LSB	±2.5 LSB	PLCC (P-20)
AD558JPZ	0°C to +70°C	±1/2 LSB	±2.5 LSB	PLCC (P-20)
AD558JPZ-REEL	0°C to +70°C	±1/2 LSB	±2.5 LSB	PLCC (P-20)
AD558JPZ-REEL7	0°C to +70°C	±1/2 LSB	±2.5 LSB	PLCC (P-20)
AD558JD	0°C to +70°C	±1/2 LSB	±2.5 LSB	SBDIP (D-16)
AD558KN	0°C to +70°C	±1/4 LSB	±1 LSB	PDIP (N-16)
AD558KNZ	0°C to +70°C	±1/4 LSB	±1 LSB	PDIP (N-16)
AD558KP	0°C to +70°C	±1/4 LSB	±1 LSB	PLCC (P-20)
AD558KPZ	0°C to +70°C	±1/4 LSB	±1 LSB	PLCC (P-20)
AD558KPZ-REEL7	0°C to +70°C	±1/4 LSB	±1 LSB	PLCC (P-20)
AD558KD	0°C to +70°C	±1/4 LSB	±1 LSB	SBDIP (D-16)
AD558SD	-55°C to +125°C	±3/4 LSB	±2.5 LSB	SBDIP (D-16)
AD558TD	-55°C to +125°C	±3/8 LSB	±1 LSB	SBDIP (D-16)
AD558TCHIPS	-55°C to +125°C	±3/8 LSB	±1 LSB	Die part
AD558SD/883B	-55°C to +125°C	±3/4 LSB	±2.5 LSB	SBDIP (D-16)
AD558SE/883B	-55°C to +125°C	±3/4 LSB	±2.5 LSB	LCC (E-20-1)
AD558TD/883B	-55°C to +125°C	±3/8 LSB	±1 LSB	SBDIP (D-16)
AD558TE/883B	-55°C to +125°C	±3/8 LSB	±1 LSB	LCC (E-20-1)

¹ For details on grade and package offerings screened in accordance with MIL-STD-883, refer to the [Analog Devices Military Products Databook](#) or current [AD558/883B](#) data sheet.

²S = Ceramic SBDIP; N = Plastic PDIP; P = Plastic Leaded Chip Carrier.

REVISION HISTORY

6/2017—Rev. A to Rev. B

Added Bond Pad Coordinates Table.....	3
Updated Outline Dimensions.....	8
Changes to Ordering Guide.....	9

Компания «Life Electronics» занимается поставками электронных компонентов импортного и отечественного производства от производителей и со складов крупных дистрибьюторов Европы, Америки и Азии.

С конца 2013 года компания активно расширяет линейку поставок компонентов по направлению коаксиальный кабель, кварцевые генераторы и конденсаторы (керамические, пленочные, электролитические), за счёт заключения дистрибьюторских договоров

Мы предлагаем:

- Конкуренспособные цены и скидки постоянным клиентам.
- Специальные условия для постоянных клиентов.
- Подбор аналогов.
- Поставку компонентов в любых объемах, удовлетворяющих вашим потребностям.
- Приемлемые сроки поставки, возможна ускоренная поставка.
- Доставку товара в любую точку России и стран СНГ.
- Комплексную поставку.
- Работу по проектам и поставку образцов.
- Формирование склада под заказчика.
- Сертификаты соответствия на поставляемую продукцию (по желанию клиента).
- Тестирование поставляемой продукции.
- Поставку компонентов, требующих военную и космическую приемку.
- Входной контроль качества.
- Наличие сертификата ISO.

В составе нашей компании организован Конструкторский отдел, призванный помогать разработчикам, и инженерам.

Конструкторский отдел помогает осуществить:

- Регистрацию проекта у производителя компонентов.
- Техническую поддержку проекта.
- Защиту от снятия компонента с производства.
- Оценку стоимости проекта по компонентам.
- Изготовление тестовой платы монтаж и пусконаладочные работы.



Тел: +7 (812) 336 43 04 (многоканальный)

Email: org@lifeelectronics.ru