

Features

(For $V^+=5V$ and $V^-=0V$ typical unless otherwise noted)

- Guaranteed 2.7V and 5V performance
- Crossover distortion eliminated
- Operating temperature range (-40°C to +85°C)
- Gain-bandwidth 1 MHz
- Low supply current
 - APX321 110 μA Typ
 - APX358 190 μA Typ
 - APX324 340 μA Typ
- Rail-to-rail output swing @ 10 k Ω
 - V^+ -10 mV
 - V^- +10 mV
- Input Common Mode Voltage Range (0 to $V^+-0.2V$)
- Manufactured in standard CMOS process
- SOT353, SOT25, MSOP-8L, SOP-8L and TSSOP-14L:
Available in "Green" Molding Compound (No Br, Sb)
- Lead-free Finish / RoHS Compliant (Note 4)

General Description





The APX321/APX358/APX324 are low voltage (2.5V to 5.5V) single, dual and quad operational amplifiers. The APX321/APX358/APX324 are designed to effectively reduce cost and space at low voltage levels. These devices have the capability of rail-to-rail output swing and input common-mode voltage range. They can also achieve an efficient speed-to-power ratio, utilizing 1 MHz bandwidth and 1 V/ μs slew rate at a low supply current. Reducing noise pickup and increasing signal integrity can be achieved by placing the device close to the signal source. The APX321 is available in 5-Pin SOT353/SOT25 packages that reduce space on pc boards and portable electronic devices. The APX324 is available in the TSSOP-14L package. The APX358 is available in the MSOP-8L and SOP-8L packages.

Applications

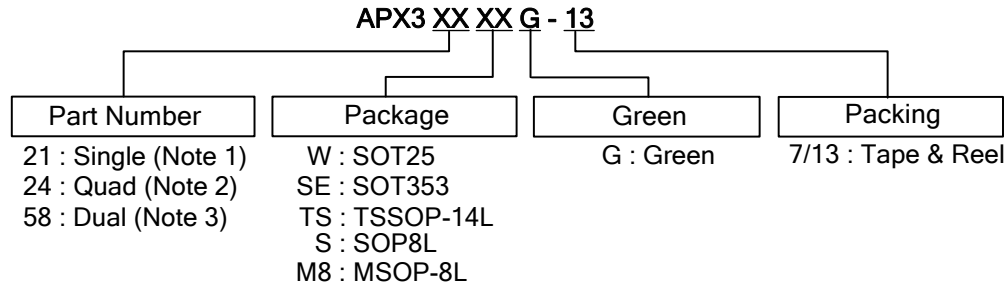
- Active filters
- General purpose low voltage applications
- General purpose portable devices

Ordering Information



Device	Package Code	Packaging (Note 5)	7"/13" Tape and Reel	
			Quantity	Part Number Suffix
 APX321WG-7	W	SOT25	3000/Tape & Reel	-7
 APX321SEG-7	SE	SOT353	3000/Tape & Reel	-7
 APX324TSG-13	TS	TSSOP-14L	2500/Tape & Reel	-13
 APX358SG-13	S	SOP-8L	2500/Tape & Reel	-13
 APX358M8G-13	M8	MSOP-8L	2500/Tape & Reel	-13

- Notes:
1. APX321 is only available for SOT25 and SOT353.
 2. APX324 is only available for TSSOP-14L.
 3. APX358 is only available for SOP-8L and MSOP-8L.
 4. EU Directive 2002/95/EC (RoHS). All applicable RoHS exemptions applied. Please visit our website at http://www.diodes.com/products/lead_free.html
 5. Pad layout as shown on Diodes Inc. suggested pad layout document AP02001, which can be found on our website at <http://www.diodes.com/datasheets/ap02001.pdf>.

Pin Assignments

(1) SOT25 / SOT353

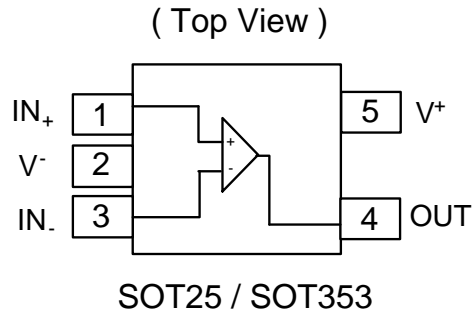

(2) SOP-8L / MSOP-8L

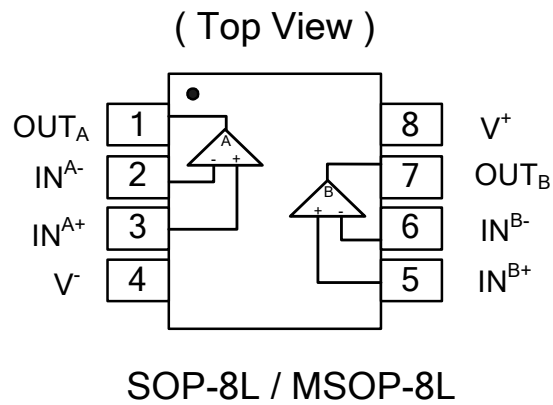

(3) TSSOP-14L

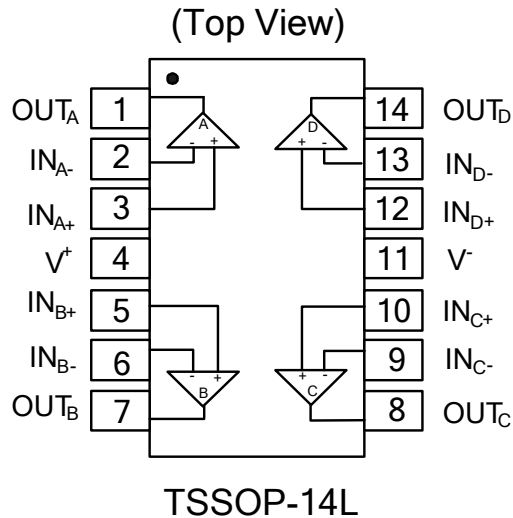



APX321/APX358/APX324

LOW VOLTAGE, RAIL-TO-RAIL INPUT AND OUTPUT SINGLE/DUAL/QUAD OPERATIONAL AMPLIFIERS

Absolute Maximum Ratings (Note 6)

Symbol	Description	Rating	Unit	
ESD HBM	Human Body Model ESD Protection	APX321	4000	V
		APX358	4000	
		APX324	4500	
ESD MM	Machine Model ESD Protection	APX321	350	V
		APX358	350	
		APX324	250	
	Differential Input Voltage	\pm Supply Voltage	V	
$V^+ - V^-$	Supply Voltage	5.5	V	
	Output Short Circuit to V^+	(Note 7)		
	Output Short Circuit to V^-	(Note 8)		
T_{ST}	Storage Temperature	-65 to 150	$^{\circ}$ C	
T_J	Maximum Junction Temperature	150	$^{\circ}$ C	

Operating Ratings (Note 6)

Symbol	Description	Rating	Unit
$V^+ - V^-$	Supply Voltage	2.5 to 5.5	V
T_A	Operating Ambient Temperature Range	-40 to +85	$^{\circ}$ C

Notes: 6. Absolute Maximum Ratings indicate limits beyond which damage to the device may occur. Operating Ratings indicate conditions for which the device is intended to be functional, but specific performance is not guaranteed. For guaranteed specifications and the test conditions, see the Electrical Characteristics.

Electrical Characteristics

2.7V DC Electrical Characteristics

Unless otherwise specified, all limits guaranteed for $T_A = 25^\circ\text{C}$, $V^+ = 2.7\text{V}$, $V^- = 0\text{V}$, $V_{CM} = 1.0\text{V}$, $V_O = V^+/2$ and $R_L > 1\text{M}\Omega$.

Symbol	Parameter	Test Conditions	Min (Note 10)	Typ. (Note 9)	Max (Note 10)	Unit
V_{OS}	Input Offset Voltage			1.7	7	mV
TCV_{OS}	Input Offset Voltage Average Drift			5		$\mu\text{V}/^\circ\text{C}$
I_B	Input Bias Current			10		nA
I_{OS}	Input Offset Current			5	50	nA
CMRR	Common Mode Rejection Ratio	$0\text{V} \leq V_{CM} \leq 2.4\text{V}$	50	63		dB
PSRR	Power Supply Rejection Ratio	$2.7\text{V} \leq V^+ \leq 5\text{V}$ $V_O = 1\text{V}$	50	60		dB
V_{CMR}	Input Common-Mode Voltage Range	For CMRR $\geq 50\text{dB}$	0	-0.2	2.5	V
V_O	Output Swing	$R_L = 10\text{ k}\Omega$ to 1.35V	$V^+ - 100$	$V^+ - 20$ 20	100	mV
I_S	Supply Current	APX321 Single amplifier		110	140	μA
		APX358 Both amplifiers		190	340	μA
		APX324 All four amplifiers		340	680	μA

2.7V AC Electrical Characteristics

Unless otherwise specified, all limits guaranteed for $T_A = 25^\circ\text{C}$, $V^+ = 2.7\text{V}$, $V^- = 0\text{V}$, $V_{CM} = 1.0\text{V}$, $V_O = V^+/2$ and $R_L > 1\text{M}\Omega$.

Symbol	Parameter	Test Conditions	Min (Note 10)	Typ. (Note 9)	Max (Note 10)	Unit
GBWP	Gain-Bandwidth Product	$C_L = 200\text{ pF}$		1		MHz
ϕ_m	Phase Margin			60		Deg
Gm	Gain Margin			10		dB
e_n	Input-Referred Voltage Noise	$f > 50\text{ KHz}$		23		$\frac{\text{nV}}{\sqrt{\text{Hz}}}$

Electrical Characteristics (Continued)

5V DC Electrical Characteristics

Unless otherwise specified, all limits guaranteed for $T_A = 25^\circ\text{C}$, $V^+ = 5\text{V}$, $V^- = 0\text{V}$, $V_{\text{CM}} = 2.0\text{V}$, $V_O = V^+/2$ and $R_L > 1\text{M}\Omega$. **Boldface** limits apply at the temperature extremes.

Symbol	Parameter	Test Conditions	Min (Note 10)	Typ. (Note 9)	Max (Note 10)	Unit
V_{OS}	Input Offset Voltage			1.7	7 9	mV
TCV_{OS}	Input Offset Voltage Average Drift			5		$\mu\text{V}/^\circ\text{C}$
I_B	Input Bias Current			15	250 500	nA
I_{OS}	Input Offset Current			5	50 150	nA
CMRR	Common Mode Rejection Ratio	$0\text{V} \leq V_{\text{CM}} \leq 4.7\text{V}$	50	65		dB
PSRR	Power Supply Rejection Ratio	$2.7\text{V} \leq V^+ \leq 5\text{V}$ $V_O = 1\text{V}$, $V_{\text{CM}} = 1\text{V}$	50	60		dB
V_{CMR}	Input Common-Mode Voltage Range	For CMRR $\geq 50\text{dB}$	0	-0.2	4.8	V
A_V	Large Signal Voltage Gain	$R_L = 2\text{ k}\Omega$ (Note 11)	15 10	100		V/mV
V_O	Output Swing	$R_L = 2\text{ k}\Omega$ to 2.5V	$V^+ - 300$ $V^+ - 400$	$V^+ - 50$		mV
				50	300 400	mV
		$R_L = 10\text{ k}\Omega$ to 2.5V	$V^+ - 100$ $V^+ - 200$	$V^+ - 10$		mV
				10	180 280	mV
I_O	Output Short Circuit Current	Sourcing, $V_O = 0\text{V}$	5	60		mA
		Sinking, $V_O = 5\text{V}$	10	90		mA
I_S	Supply Current	APX321 Single amplifier		110	140	μA
		APX358 Both amplifiers		190	340 600	μA
		APX324 All four amplifiers		340	680 1100	μA
θ_{JA}	Thermal Resistance Junction-to-Ambient	SOT353 (Note 12)		330		$^\circ\text{C}/\text{W}$
		SOT25 (Note 12)		250		$^\circ\text{C}/\text{W}$
		TSSOP-14L (Note 12)		100		$^\circ\text{C}/\text{W}$
		MSOP-8L (Note 12)		203		$^\circ\text{C}/\text{W}$
		SOP-8L (Note 12)		150		$^\circ\text{C}/\text{W}$

Electrical Characteristics (Continued)

5V AC Electrical Characteristics

Unless otherwise specified, all limits guaranteed for $T_A = 25^\circ\text{C}$, $V^+ = 5\text{V}$, $V^- = 0\text{V}$, $V_{\text{CM}} = 2.0\text{V}$, $V_O = V^+/2$ and $R_L > 1\text{M}\Omega$. **Boldface** limits apply at the temperature extremes.

Symbol	Parameter	Test Conditions	Min (Note 10)	Typ. (Note 9)	Max (Note 10)	Unit
SR	Slew Rate	(Note 13)		1		V/ μs
GBWP	Gain-Bandwidth Product	$C_L = 200\text{ pF}$		1		MHz
Φ_m	Phase Margin			60		Deg
G_m	Gain Margin			10		dB
e_n	Input-Referred Voltage Noise	$f > 50\text{ KHz}$		23		$\frac{\text{nV}}{\sqrt{\text{Hz}}}$

- Notes:
7. Shorting output to V^+ will adversely affect reliability.
 8. Shorting output to V^- will adversely affect reliability.
 9. Typical values represent the most likely parametric norm as determined at the time of characterization. Actual typical values may vary over time and will also depend on the application and configuration. The typical values are not tested and are not guaranteed on shipped production material.
 10. All limits are guaranteed by testing or statistical analysis.
 11. R_L is connected to V^- . The output voltage is $0.5\text{V} \leq V_O \leq 4.5\text{V}$.
 12. All numbers are typical, and apply for packages soldered directly onto a PC board in still air.
 13. Connected as voltage follower with 3V step input. Number specified is the slower of the positive and negative slew rates.

Typical Performance Characteristics

Unless otherwise specified, $V_s = +5V$, single supply, $T_A = 25^\circ C$

Supply Current vs. Supply Voltage

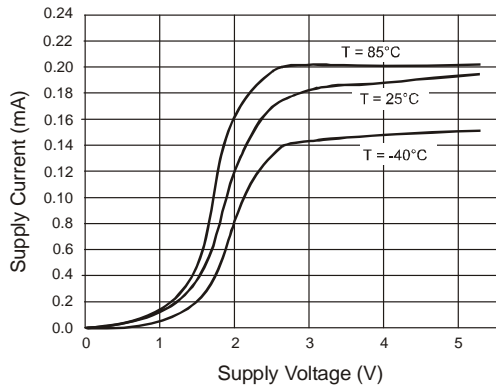

Output Voltage Swing vs. Supply Voltage

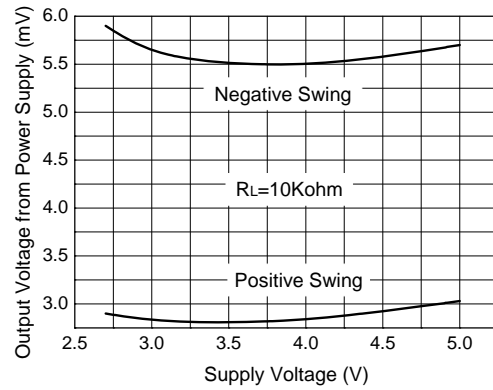

PSRR vs. Frequency

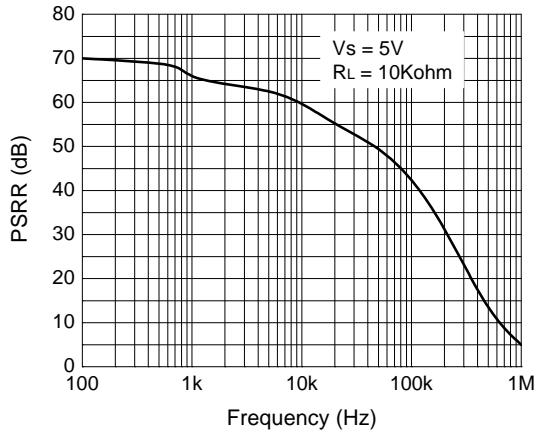

CMRR vs. Frequency

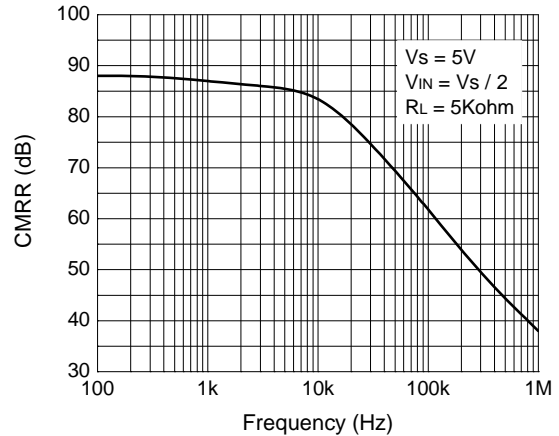

CMRR vs. Input Common Mode Voltage

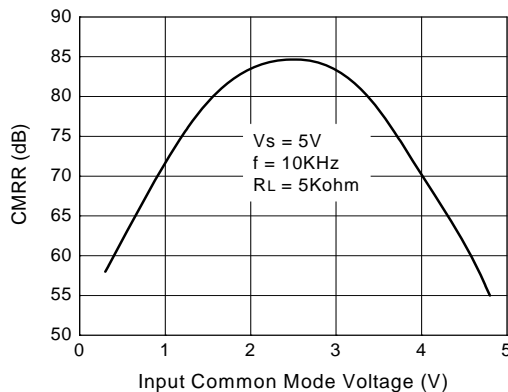

ΔV_{os} vs. CMR

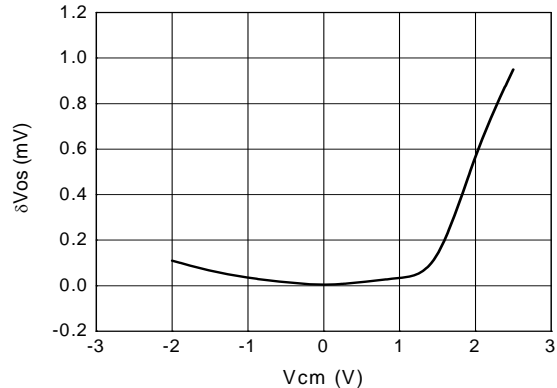

Typical Performance Characteristics (Continued)

Sourcing Current vs. Output Voltage (2.7V)

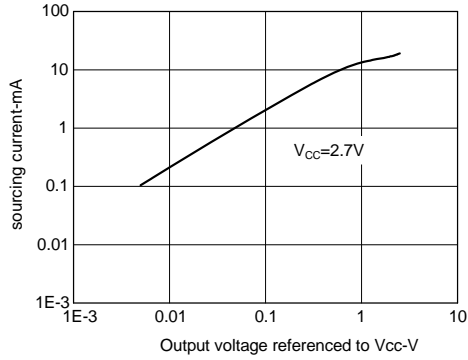

Sourcing Current vs. Output Voltage (5V)

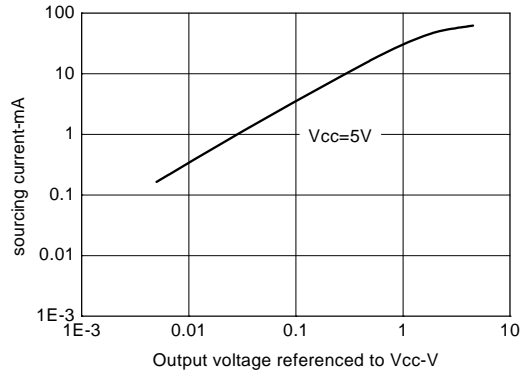

Sinking Current vs. Output Voltage (2.7V)

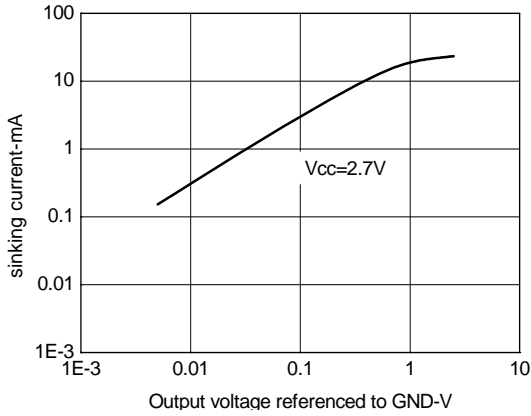

Sinking Current vs. Output Voltage (5V)

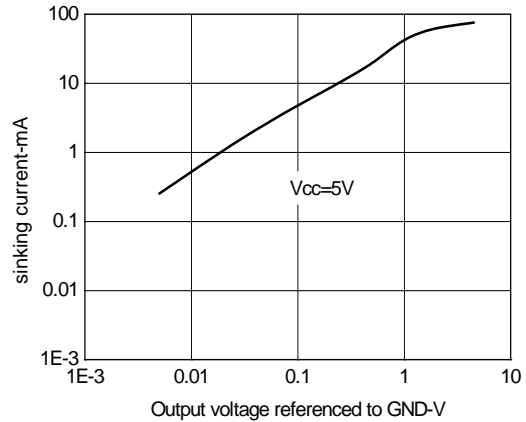

Input Voltage vs. Output Voltage

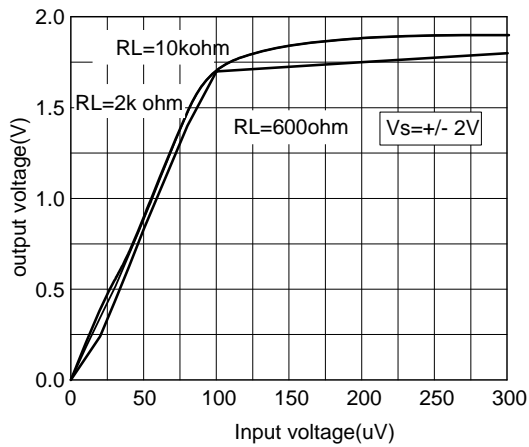

Typical Performance Characteristics (Continued)

Frequency Response vs. Resistive Load (2.7V)

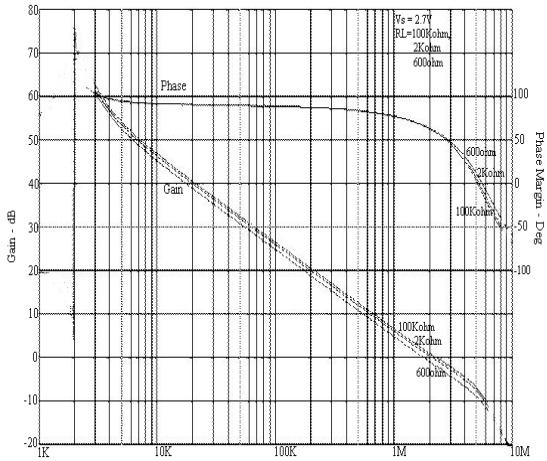

Frequency Response vs. Resistive Load (5V)

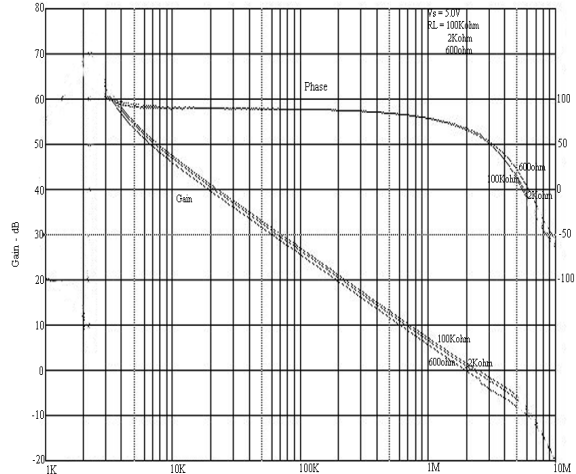

Frequency Response vs. Capacitive Load (2.7V)

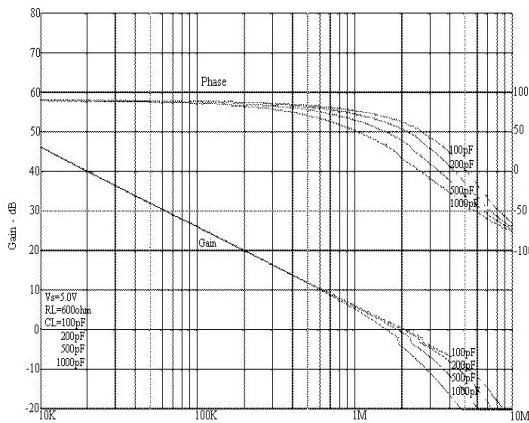

Frequency Response vs. Capacitive Load (5V)

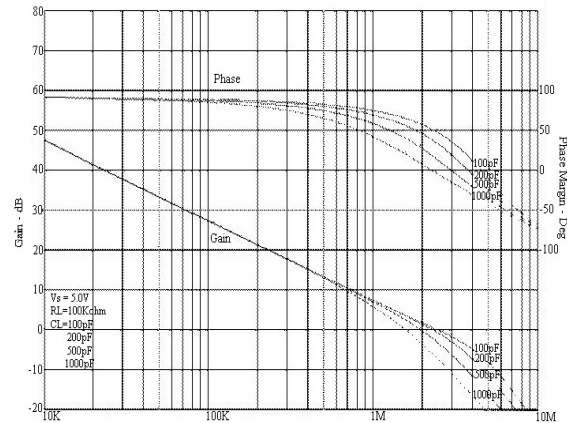

Non-Inverting Large Signal Pulse Response

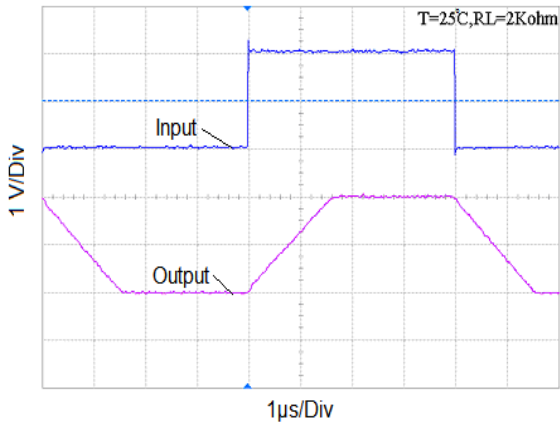

Non-Inverting Large Signal Pulse Response

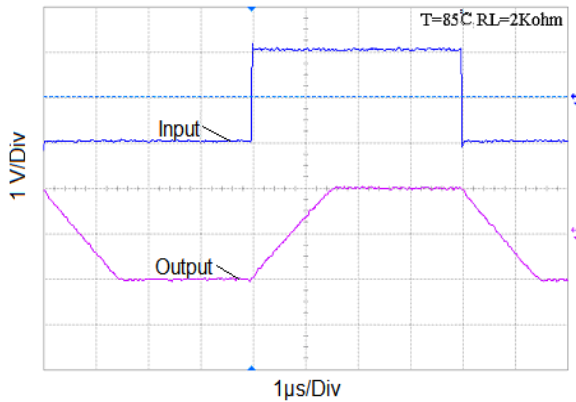

Typical Performance Characteristics (Continued)

Non-Inverting Large Signal Pulse Response

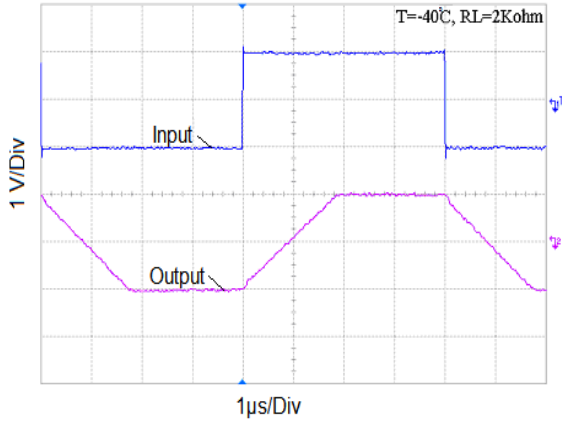

Non-Inverting Small Signal Pulse Response

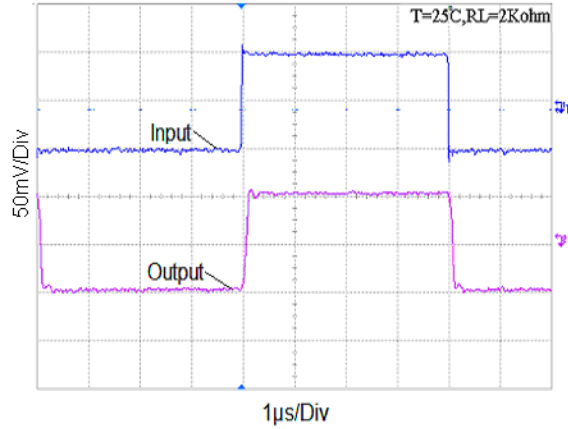

Non-Inverting Small Signal Pulse Response

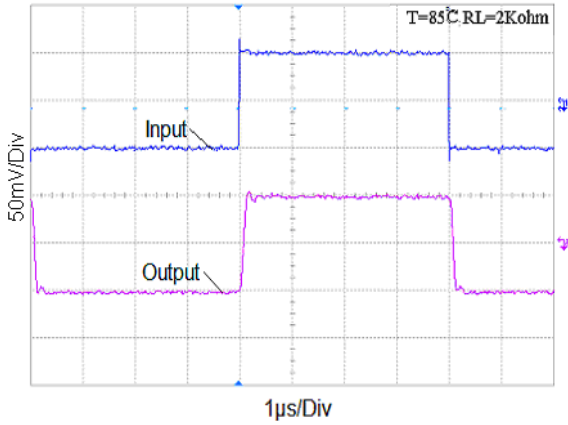

Non-Inverting Small Signal Pulse Response

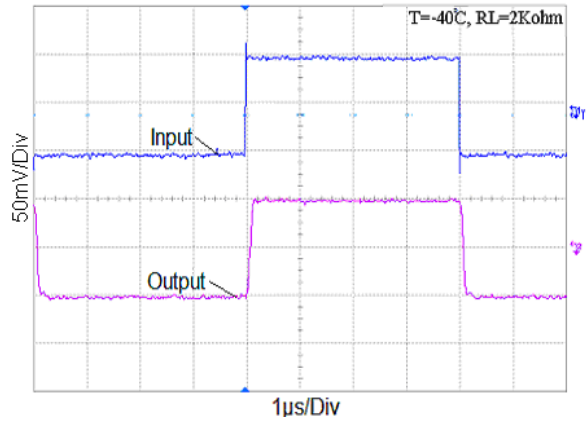

Inverting Large Signal Pulse Response

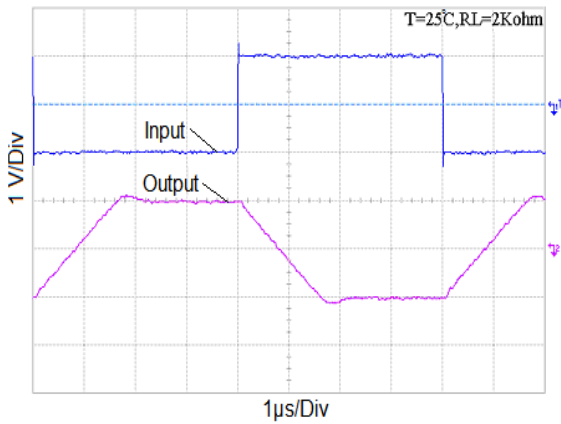

Inverting Large Signal Pulse Response

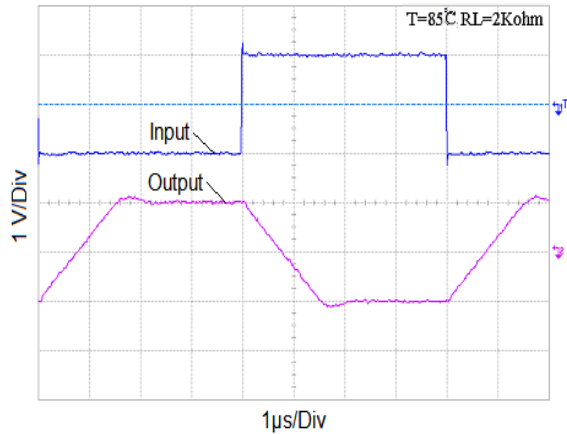

Typical Performance Characteristics (Continued)

Inverting Large Signal Pulse Response

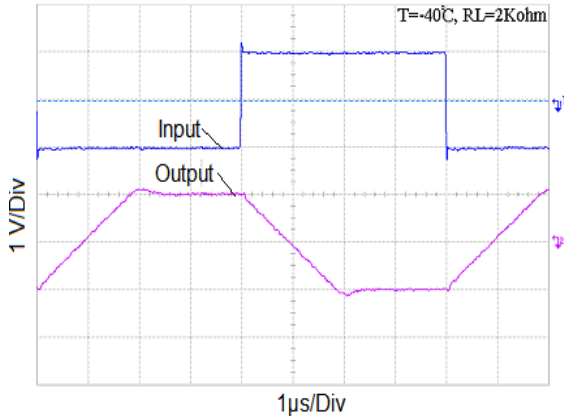

Inverting Small Signal Pulse Response

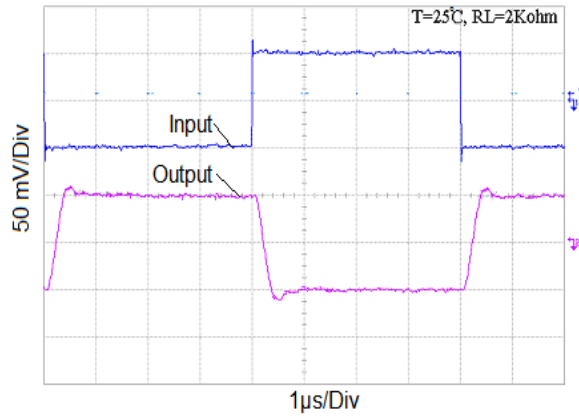

Inverting Small Signal Pulse Response

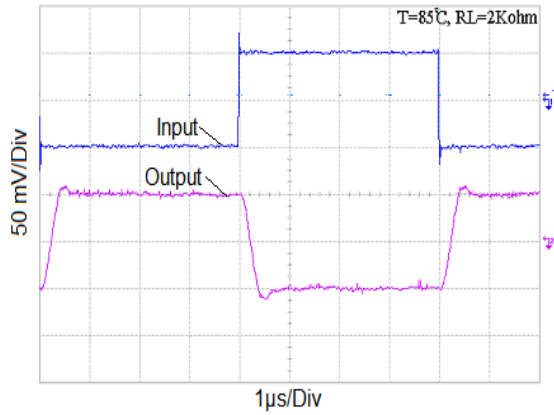

Inverting Small Signal Pulse Response

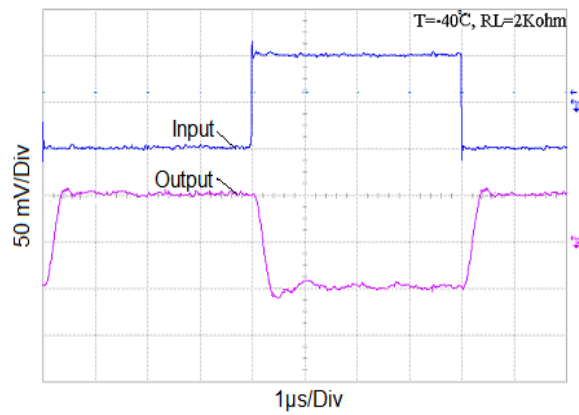

Stability vs. Capacitive Load

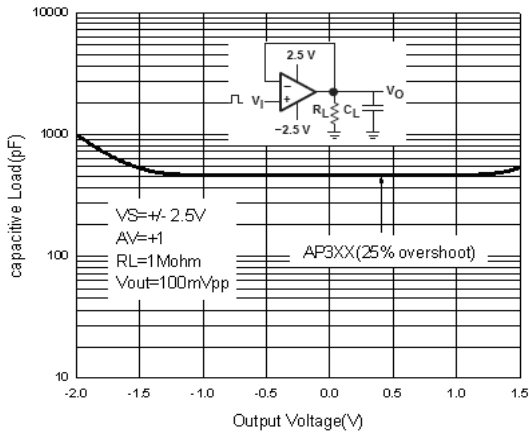

Stability vs. Capacitive Load

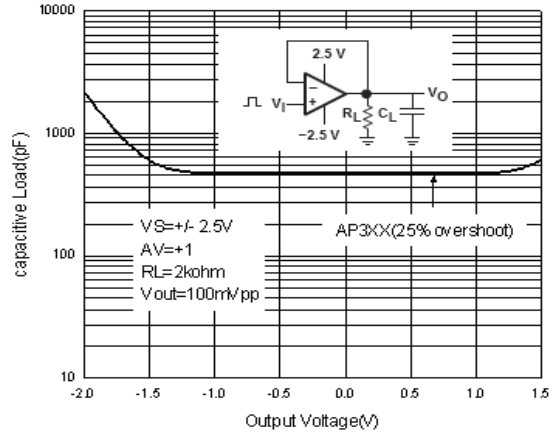

Typical Performance Characteristics (Continued)

Stability vs. Capacitive Load

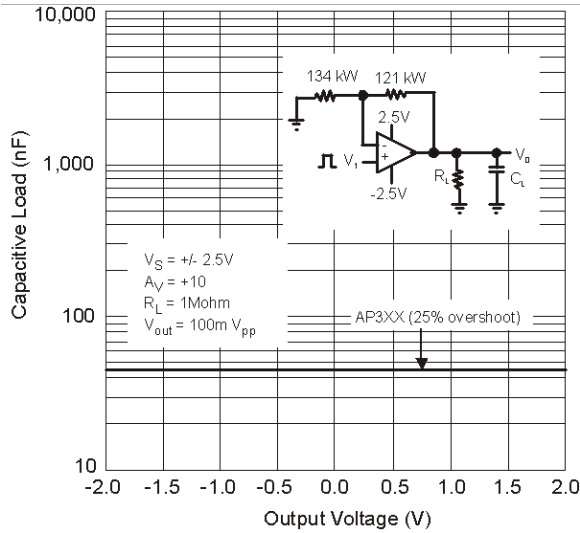

Stability vs. Capacitive Load

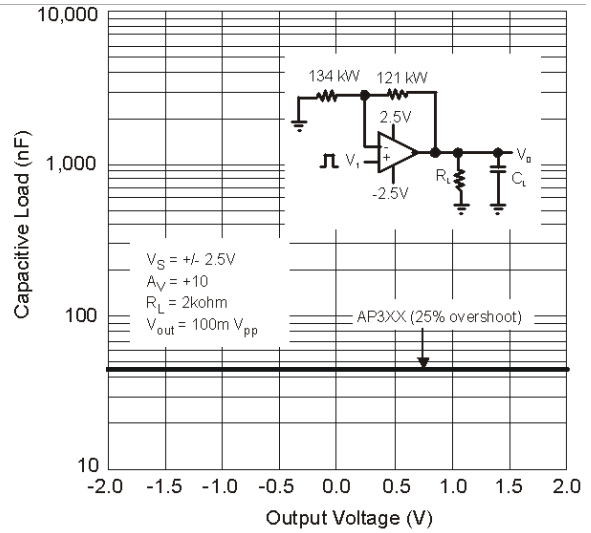

Slew Rate vs. Supply Voltage

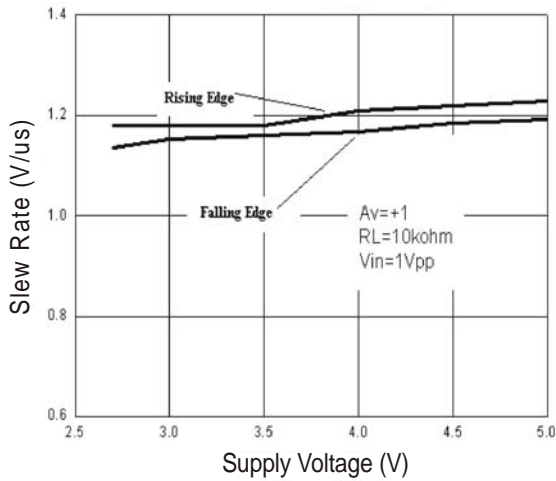

Input Voltage Noise

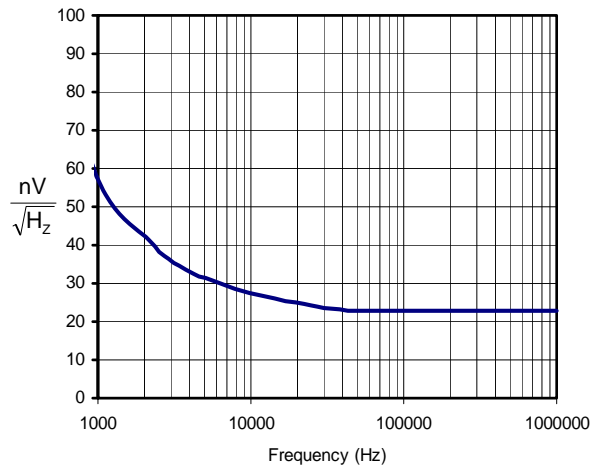

Typical Performance Characteristics (Continued)

Input Voltage Noise (2.7V)

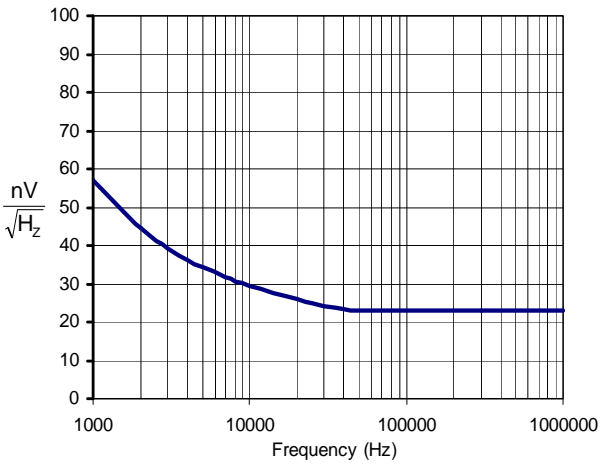

Marking Information

(1) SOT25 / SOT353

(Top View)

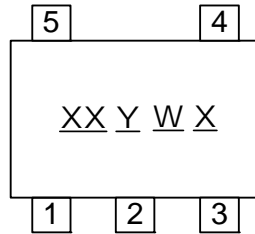

XX : Identification code
Y : Year 0~9
W : Week : A~Z : 1~26 week;
 a~z : 27~52 week; z represents
 52 and 53 week
X : A~Z : Green

Device	Package type	Identification Code
APX321W	SOT25	V2
APX321SE	SOT353	V3

(2) TSSOP-14L

(Top View)

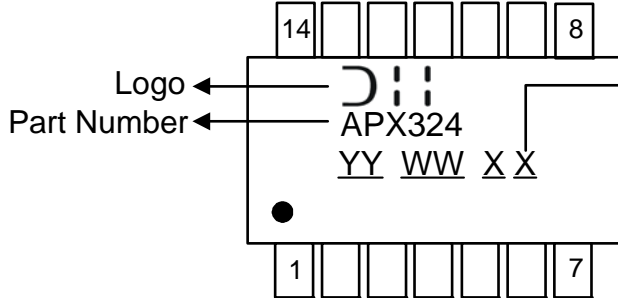

G : Green
YY : Year : 08, 09,10~
WW : Week : 01~52; 52
 represents 52 and 53 week
X : Internal Code

(3) SOP-8L

(Top View)

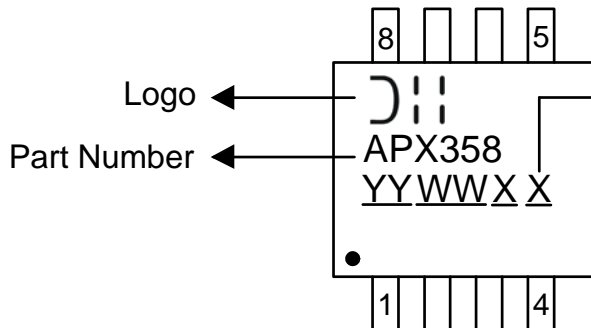

G : Green
YY : Year : 08, 09,10~
WW : Week : 01~52; 52
 represents 52 and 53 week
X : Internal Code

Marking Information (Continued)

(4) MSOP-8L

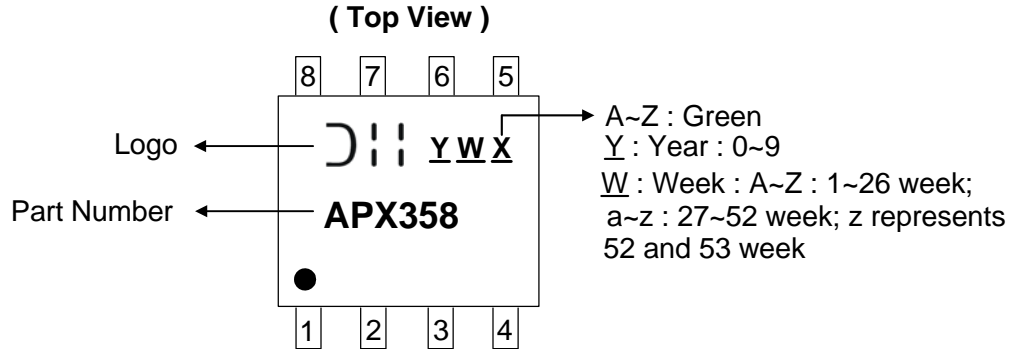

Package Information (All Dimensions in mm)

(1) Package Type: SOT25

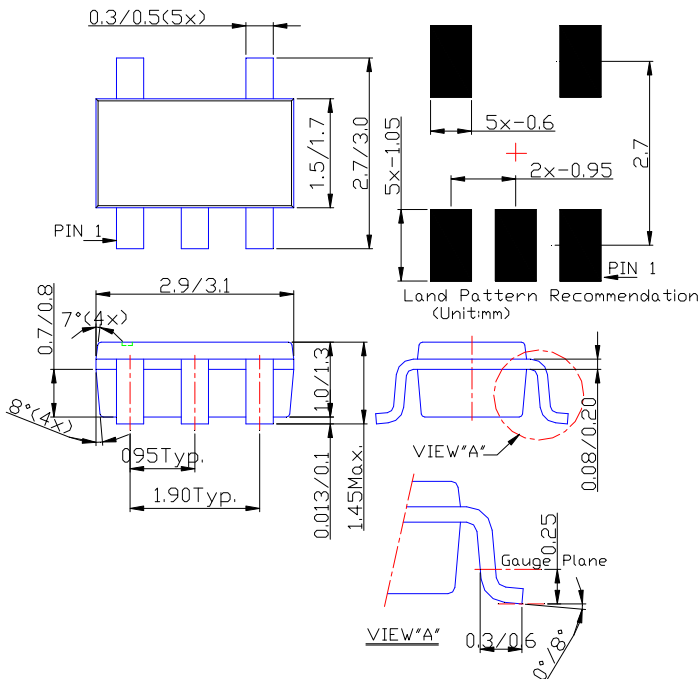

Package Information (Continued)

(4) Package Type: SOP-8L

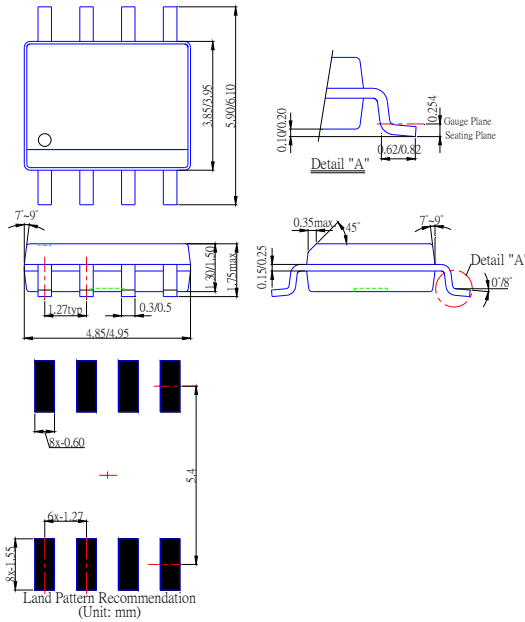

(5) Package Type: MSOP-8L

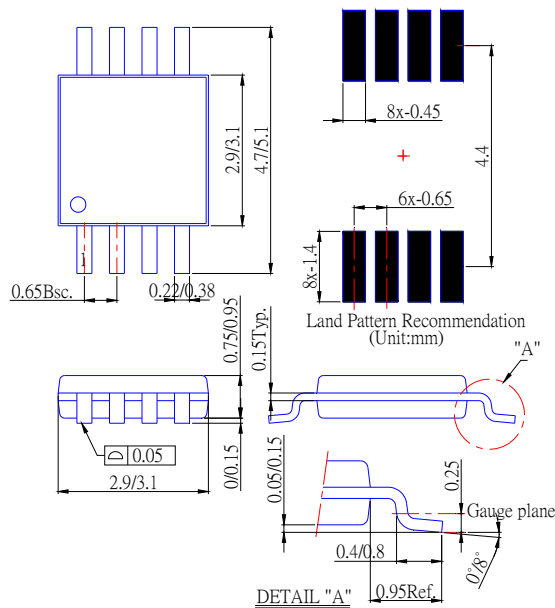



APX321/APX358/APX324

LOW VOLTAGE, RAIL-TO-RAIL INPUT AND OUTPUT SINGLE/DUAL/QUAD OPERATIONAL AMPLIFIERS

IMPORTANT NOTICE

Diodes Incorporated and its subsidiaries reserve the right to make modifications, enhancements, improvements, corrections or other changes without further notice to any product herein. Diodes Incorporated does not assume any liability arising out of the application or use of any product described herein; neither does it convey any license under its patent rights, nor the rights of others. The user of products in such applications shall assume all risks of such use and will agree to hold Diodes Incorporated and all the companies whose products are represented on our website, harmless against all damages.

LIFE SUPPORT

Diodes Incorporated products are not authorized for use as critical components in life support devices or systems without the expressed written approval of the President of Diodes Incorporated.

Компания «Life Electronics» занимается поставками электронных компонентов импортного и отечественного производства от производителей и со складов крупных дистрибьюторов Европы, Америки и Азии.

С конца 2013 года компания активно расширяет линейку поставок компонентов по направлению коаксиальный кабель, кварцевые генераторы и конденсаторы (керамические, пленочные, электролитические), за счёт заключения дистрибьюторских договоров

Мы предлагаем:

- Конкурентоспособные цены и скидки постоянным клиентам.
- Специальные условия для постоянных клиентов.
- Подбор аналогов.
- Поставку компонентов в любых объемах, удовлетворяющих вашим потребностям.
- Приемлемые сроки поставки, возможна ускоренная поставка.
- Доставку товара в любую точку России и стран СНГ.
- Комплексную поставку.
- Работу по проектам и поставку образцов.
- Формирование склада под заказчика.
- Сертификаты соответствия на поставляемую продукцию (по желанию клиента).
- Тестирование поставляемой продукции.
- Поставку компонентов, требующих военную и космическую приемку.
- Входной контроль качества.
- Наличие сертификата ISO.

В составе нашей компании организован Конструкторский отдел, призванный помогать разработчикам, и инженерам.

Конструкторский отдел помогает осуществить:

- Регистрацию проекта у производителя компонентов.
- Техническую поддержку проекта.
- Защиту от снятия компонента с производства.
- Оценку стоимости проекта по компонентам.
- Изготовление тестовой платы монтаж и пусконаладочные работы.



Тел: +7 (812) 336 43 04 (многоканальный)

Email: org@lifeelectronics.ru