

Features

- **Advanced, High-speed, Electrically-erasable Programmable Logic Device**
 - Superset of 22V10
 - Enhanced Logic Flexibility
 - Backward Compatible with ATV750B/BL and ATV750/L
- **Low-power Edge-sensing “L” Option with 1 mA Standby Current**
- **D- or T-type Flip-flop**
- **Product Term or Direct Input Pin Clocking for Flip-flop**
- **7.5 ns Maximum Pin-to-pin Delay with 5V Operation**
- **Highest Density Programmable Logic Available in 24-pin and 28-pin Packages**
 - Advanced Electrically-erasable Technology
 - Reprogrammable
 - 100% Tested
- **Increased Logic Flexibility**
 - 42 Array Inputs, 20 Sum Terms and 20 Flip-flops
- **Enhanced Output Logic Flexibility**
 - All 20 Flip-flops Feed Back Internally
 - 10 Flip-flops are also Available as Outputs
- **Programmable Pin-keeper Circuits**
- **Dual-in-line and Surface Mount Package in Standard Pinouts**
- **Full Military, Commercial and Industrial Temperature Ranges**
- **20-year Data Retention**
- **2000V ESD Protection**
- **1000 Erase/Write Cycles**
- **Green Package Options (Pb/Halide-free/RoHS Compliant) Available**

1. Block Diagram



**High-speed
Complex
Programmable
Logic Device**

**ATF750C
ATF750CL**

2. Pin Configurations

| Pin | Function |
|-----|------------------------|
| CLK | Clock |
| IN | Logic Inputs |
| I/O | Bi-directional Buffers |
| GND | Ground |
| VCC | +5V Supply |

2.1 DIP/SOIC/TSSOP



2.2 PLCC/LCC



Note: For PLCC, pins 1, 8, 15, and 22 can be left unconnected. For superior performance, connect VCC to pin 1 and GND to pins 8, 15, and 22.

3. Description

The ATF750C(L)s are twice as powerful as most other 24-pin programmable logic devices. Increased product terms, sum terms, flip-flops and output logic configurations

translate into more usable gates. High-speed logic and uniform predictable delays guarantee fast in-system performance. The ATF750C(L) is a high-performance CMOS (electrically-erasable) complex programmable logic device (CPLD) that utilizes Atmel's proven electrically-erasable technology.

Each of the ATF750C(L)'s 22 logic pins can be used as an input. Ten of these can be used as inputs, outputs or bi-directional I/O pins. Each flip-flop is individually configurable as either D- or T-type. Each flip-flop output is fed back into the array independently. This allows burying of all the sum terms and flip-flops.

There are 171 total product terms available. There are two sum terms per output, providing added flexibility. A variable format is used to assign between four to eight product terms per sum term. Much more logic can be replaced by this device than by any other 24-pin PLD. With 20 sum terms and flip-flops, complex state machines are easily implemented with logic to spare.

Product terms provide individual clocks and asynchronous resets for each flip-flop. Each flip-flop may also be individually configured to have direct input pin controlled clocking. Each output has its own enable product term. One product term provides a common synchronous preset for all flip-flops. Register preload functions are provided to simplify testing. All registers automatically reset upon power-up.

The ATF750CL is a low-power device with speeds as fast as 15 ns. The ATF750CL provides the optimum low-power CPLD solution. This device significantly reduces total system power, thereby allowing battery-powered operations.

4. Absolute Maximum Ratings*

| | |
|--|--------------------------------|
| Temperature Under Bias..... | -55°C to +125°C |
| Storage Temperature | -65°C to +150°C |
| Voltage on Any Pin with Respect to Ground | -2.0V to +7.0V ⁽¹⁾ |
| Voltage on Input Pins with Respect to Ground During Programming..... | -2.0V to +14.0V ⁽¹⁾ |
| Programming Voltage with Respect to Ground | -2.0V to +14.0V ⁽¹⁾ |

*NOTICE: Stresses beyond those listed under “Absolute Maximum Ratings” may cause permanent damage to the device. This is a stress rating only and functional operation of the device at these or any other conditions beyond those indicated in the operational sections of this specification is not implied. Exposure to absolute maximum rating conditions for extended periods may affect device reliability.

Note: 1. Minimum voltage is -0.6V DC, which may undershoot to -2.0V for pulses of less than 20 ns. Maximum output pin voltage is $V_{CC} + 0.75V$ DC, which may overshoot to 7.0V for pulses of less than 20 ns.

5. DC and AC Operating Conditions

All members of the family are specified to operate in either one of two voltage ranges. Parameters are specified as noted to be either 2.7V to 3.6V, 5V $\pm 5\%$ or 5V $\pm 10\%$.

| 5V Operation | Commercial -7.5, -10, -15 | Industrial -10, -15 | Military |
|---------------------------------|------------------------------|------------------------|--------------------------|
| Operating Temperature (Ambient) | 0°C - 70°C | -40°C - +85°C | -55°C - +125°C (case) |
| V_{CC} Power Supply | 5V $\pm 5\%$ | 5V $\pm 10\%$ | 5V $\pm 10\%$ |

6. Logic Options

Combinatorial Output



Registered Output



7. Clock Mux

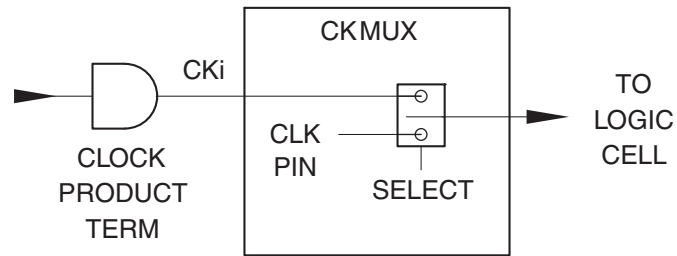

8. Output Options

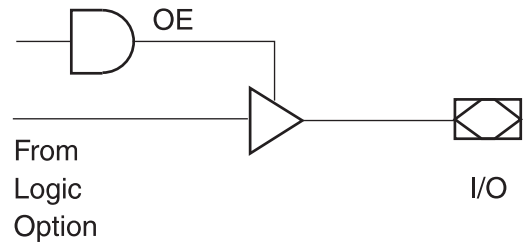
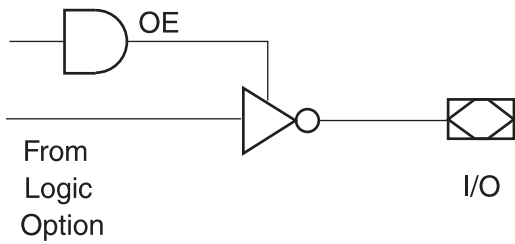

9. Bus-friendly Pin-keeper Input and I/Os

All input and I/O pins on the ATF750C(L) have programmable “pin-keeper” circuits. If activated, when any pin is driven high or low and then subsequently left floating, it will stay at that previous high or low level.

This circuitry prevents unused input and I/O lines from floating to intermediate voltage levels, which causes unnecessary power consumption and system noise. The keeper circuits eliminate the need for external pull-up resistors and eliminate their DC power consumption.

Enabling or disabling of the pin-keeper circuits is controlled by the device type chosen in the logic compiler device selection menu. Please refer to the software compiler table for more details. Once the pin-keeper circuits are disabled, normal termination procedures are required for unused inputs and I/Os.

10. Input Diagram

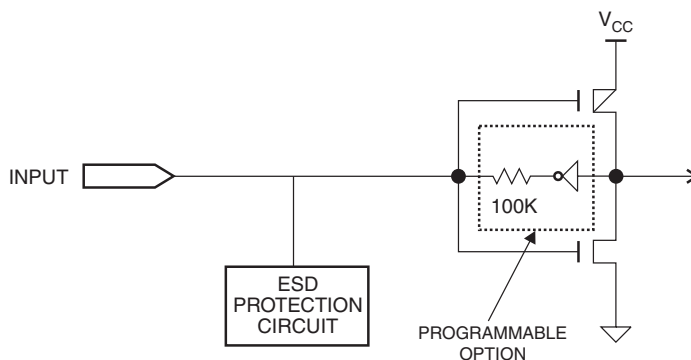

11. I/O Diagram

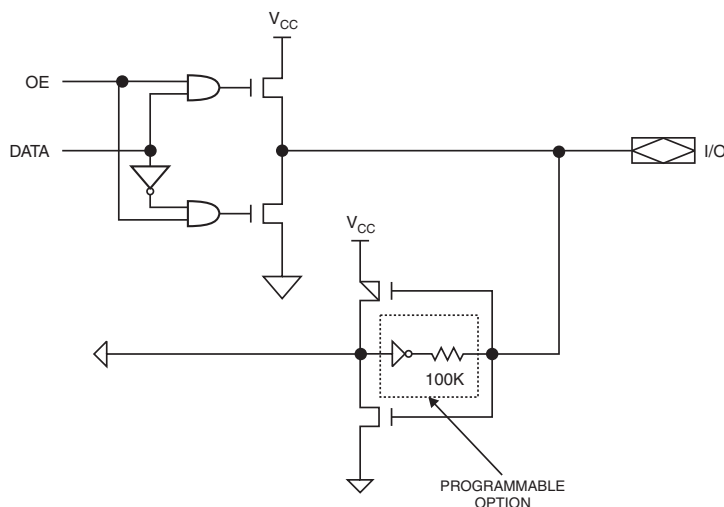

12. DC Characteristics

| Symbol | Parameter | Condition | Min | Typ | Max | Units | |
|----------------|-------------------------------|--|----------------------------|------------|-----------------|---------|----|
| I_{LI} | Input Load Current | $V_{IN} = -0.1V$ to $V_{CC} + 1V$ | | | 10 | μA | |
| I_{LO} | Output Leakage Current | $V_{OUT} = -0.1V$ to $V_{CC} + 0.1V$ | | | 10 | μA | |
| I_{CC} | Power Supply Current, Standby | $V_{CC} = \text{Max},$ $V_{IN} = \text{Max},$ Outputs Open | C-7, -10 | Com. | 125 | 180 | mA |
| | | | | Ind., Mil. | 135 | 190 | mA |
| | | | C-15 | Com. | 125 | 180 | mA |
| | | | | Ind., Mil. | 135 | 190 | mA |
| | | | CL-15 | Com. | 0.12 | 1 | mA |
| Ind. | 0.15 | 2 | mA | | | | |
| $I_{OS}^{(1)}$ | Output Short Circuit Current | $V_{OUT} = 0.5V$ | | | -120 | mA | |
| V_{IL} | Input Low Voltage | $4.5 \leq V_{CC} \leq 5.5V$ | -0.6 | | 0.8 | V | |
| V_{IH} | Input High Voltage | | 2.0 | | $V_{CC} + 0.75$ | V | |
| V_{OL} | Output Low Voltage | $V_{IN} = V_{IH}$ or $V_{IL},$ $V_{CC} = \text{Min}$ | $I_{OL} = 16 \text{ mA}$ | Com., Ind. | | 0.5 | V |
| | | | $I_{OL} = 12 \text{ mA}$ | Mil. | | 0.5 | V |
| | | | $I_{OL} = 24 \text{ mA}$ | Com. | | 0.8 | V |
| V_{OH} | Output High Voltage | $V_{IN} = V_{IH}$ or $V_{IL},$ $V_{CC} = \text{Min}$ | $I_{OH} = -4.0 \text{ mA}$ | 2.4 | | V | |

Note: 1. Not more than one output at a time should be shorted. Duration of short circuit test should not exceed 30 sec.

13. Input Test Waveforms and Measurement Levels



14. Output Test Load

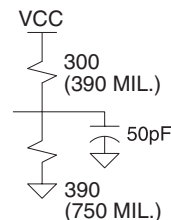

15. AC Waveforms, Product Term Clock⁽¹⁾

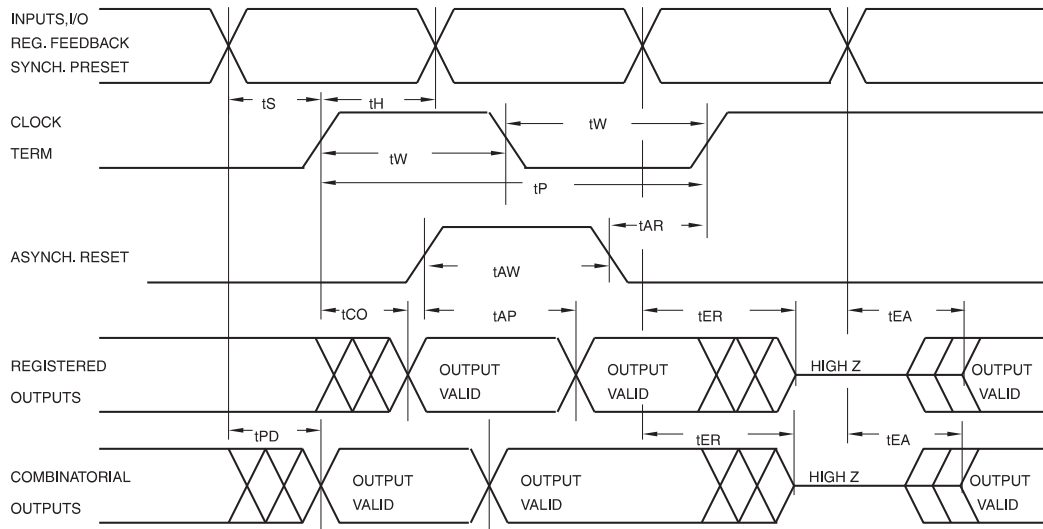

Note: 1. Timing measurement reference is 1.5V. Input AC driving levels are 0.0V and 3.0V, unless otherwise specified.

16. AC Characteristics, Product Term Clock⁽¹⁾

| Symbol | Parameter | -7 | | -10 | | C/CL-15 | | Units |
|-----------|---|-----|-----|-----|-----|---------|-----|-------|
| | | Min | Max | Min | Max | Min | Max | |
| t_{PD} | Input or Feedback to Non-registered Output | | 7.5 | 10 | | 15 | | ns |
| t_{EA} | Input to Output Enable | | 7.5 | 10 | | 15 | | ns |
| t_{ER} | Input to Output Disable | | 7.5 | 10 | | 15 | | ns |
| t_{CO} | Clock to Output | 3 | 7.5 | 4 | 10 | 5 | 12 | ns |
| t_{CF} | Clock to Feedback | 1 | 5 | 4 | 7.5 | 5 | 9 | ns |
| t_S | Input Setup Time | 3 | | 4 | | 8/12 | | ns |
| t_{SF} | Feedback Setup Time | 3 | | 4 | | 7 | | ns |
| t_H | Hold Time | 1 | | 2 | | 5 | | ns |
| t_P | Clock Period | 7 | | 11 | | 14 | | ns |
| t_W | Clock Width | 3.5 | | 5.5 | | 7 | | ns |
| f_{MAX} | External Feedback $1/(t_S + t_{CO})$ | | 95 | 71 | | 50/41 | | MHz |
| | Internal Feedback $1/(t_{SF} + t_{CF})$ | | 125 | 86 | | 62 | | MHz |
| | No Feedback $1/(t_P)$ | | 142 | 90 | | 71 | | MHz |
| t_{AW} | Asynchronous Reset Width | 5 | | 10 | | 15 | | ns |
| t_{AR} | Asynchronous Reset Recovery Time | 3 | | 10 | | 15 | | ns |
| t_{AP} | Asynchronous Reset to Registered Output Reset | | 8 | 12 | | 15 | | ns |
| t_{SP} | Setup Time, Synchronous Preset | 4 | | 7 | | 8 | | ns |

Note: 1. See ordering information for valid part numbers.

17. AC Waveforms, Input Pin Clock⁽¹⁾

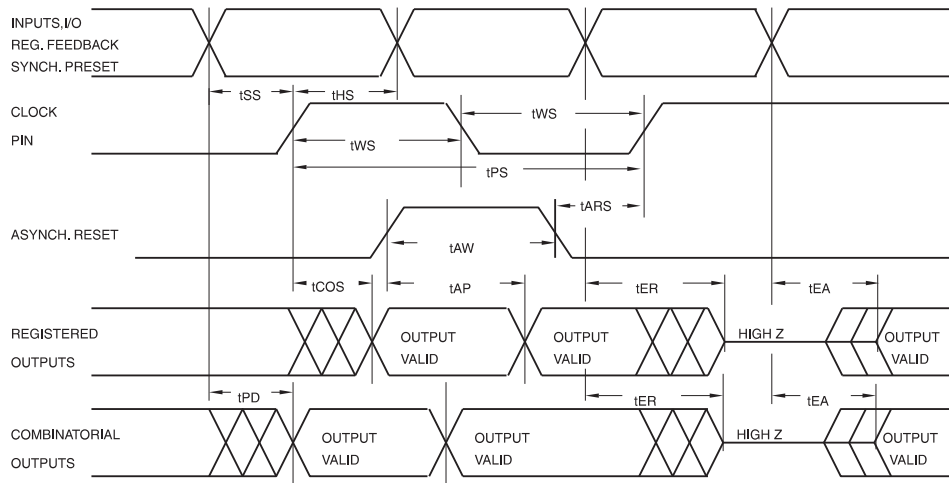

Note: 1. Timing measurement reference is 1.5V. Input AC driving levels are 0.0V and 3.0V, unless otherwise specified.

18. AC Characteristics, Input Pin Clock

| Symbol | Parameter | -7 | | -10 | | C/CL-15 | | Units |
|------------|---|-----|-----|-----|-----|---------|-------|-------|
| | | Min | Max | Min | Max | Min | Max | |
| t_{PD} | Input or Feedback to Non-registered Output | | 7.5 | | 10 | | 15 | ns |
| t_{EA} | Input to Output Enable | | 7.5 | | 10 | | 15 | ns |
| t_{ER} | Input to Output Disable | | 7.5 | | 10 | | 15 | ns |
| t_{COS} | Clock to Output | 0 | 6.5 | 0 | 7 | 0 | 10 | ns |
| t_{CFS} | Clock to Feedback | 0 | 3.5 | 0 | 5 | 0 | 5.5 | ns |
| t_{SS} | Input Setup Time | 4 | | 5 | | 8/12.5 | | ns |
| t_{SFS} | Feedback Setup Time | 4 | | 5 | | 7 | | ns |
| t_{HS} | Hold Time | 0 | | 0 | | 0 | | ns |
| t_{PS} | Clock Period | 7 | | 10 | | 12 | | ns |
| t_{WS} | Clock Width | 3.5 | | 5 | | 6 | | ns |
| f_{MAXS} | External Feedback $1/(t_{SS} + t_{COS})$ | | 95 | | 83 | | 55/44 | MHz |
| | Internal Feedback $1/(t_{SFS} + t_{CFS})$ | | 133 | | 100 | | 80 | MHz |
| | No Feedback $1/(t_{PS})$ | | 142 | | 100 | | 83 | MHz |
| t_{AW} | Asynchronous Reset Width | 5 | | 10 | | 15 | | ns |
| t_{ARS} | Asynchronous Reset Recovery Time | 5 | | 10 | | 15 | | ns |
| t_{AP} | Asynchronous Reset to Registered Output Reset | | 8 | | 10 | | 15 | ns |
| t_{SPS} | Setup Time, Synchronous Preset | 5 | | 5/9 | | 11 | | ns |

19. Functional Logic Diagram ATF750C, Upper Half



20. Functional Logic Diagram ATF750C, Lower Half

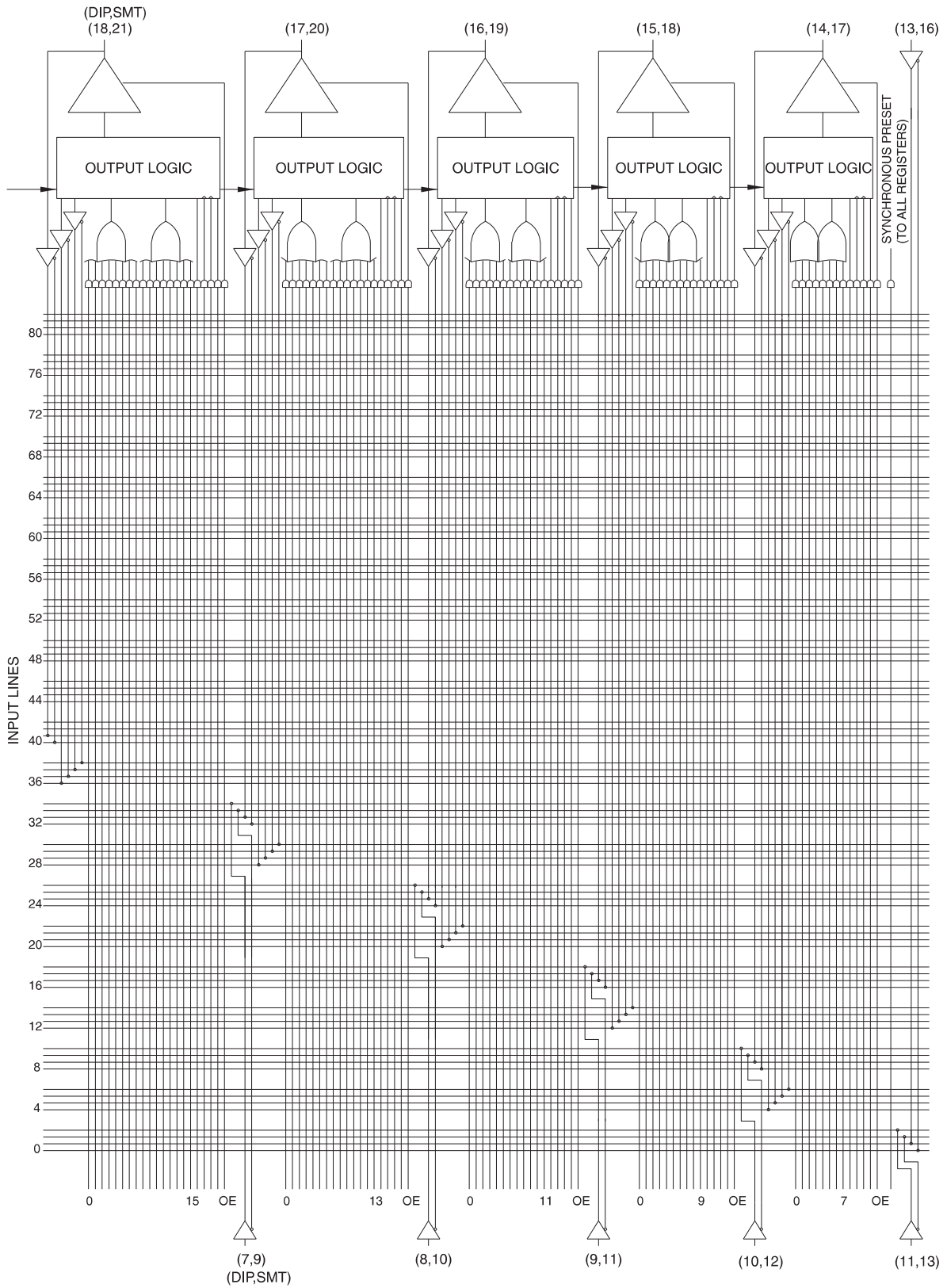

21. Power-up Reset

The registers in the ATF750C(L)s are designed to reset during power-up. At a point delayed slightly from V_{CC} crossing V_{RST} , all registers will be reset to the low state. The output state will depend on the polarity of the output buffer.

This feature is critical for state machine initialization. However, due to the asynchronous nature of reset and the uncertainty of how V_{CC} actually rises in the system, the following conditions are required:

1. The V_{CC} rise must be monotonic,
2. After reset occurs, all input and feedback setup times must be met before driving the clock terms or pin high, and
3. The clock pin, or signals from which clock terms are derived, must remain stable during t_{PR} .



| Parameter | Description | Typ | Max | Units |
|-----------|------------------------|-----|------|-------|
| t_{PR} | Power-up Reset Time | 600 | 1000 | ns |
| V_{RST} | Power-up Reset Voltage | 2.0 | 4.5 | V |

22. Pin Capacitance

$f = 1 \text{ MHz}$, $T = 25^\circ\text{C}^{(1)}$

| | Typ | Max | Units | Conditions |
|-----------|-----|-----|-------|----------------|
| C_{IN} | 5 | 8 | pF | $V_{IN} = 0V$ |
| C_{OUT} | 6 | 8 | pF | $V_{OUT} = 0V$ |

Note: 1. Typical values for nominal supply voltage. This parameter is only sampled and is not 100% tested.

23. Using the ATF750C's Many Advanced Features

The ATF750C(L)'s advanced flexibility packs more usable gates into 24 pins than any other logic device. The ATF750C(L)s start with the popular 22V10 architecture, and add several enhanced features:

- **Selectable D- and T-type Registers**

Each ATF750C(L) flip-flop can be individually configured as either D- or T-type. Using the T-type configuration, JK and SR flip-flops are also easily created. These options allow more efficient product term usage.

- **Selectable Asynchronous Clocks**

Each of the ATF750C(L)'s flip-flops may be clocked by its own clock product term or directly from Pin 1 (SMD Lead 2). This removes the constraint that all registers must use the same clock. Buried state machines, counters and registers can all coexist in one device while running on separate clocks. Individual flip-flop clock source selection further allows mixing higher performance pin clocking and flexible product term clocking within one design.

- **A Full Bank of Ten More Registers**

The ATF750C(L) provides two flip-flops per output logic cell for a total of 20. Each register has its own sum term, its own reset term and its own clock term.

- **Independent I/O Pin and Feedback Paths**

Each I/O pin on the ATF750C(L) has a dedicated input path. Each of the 20 registers has its own feedback terms into the array as well. This feature, combined with individual product terms for each I/O's output enable, facilitates true bi-directional I/O design.

24. Synchronous Preset and Asynchronous Reset

One synchronous preset line is provided for all 20 registers in the ATF750C(L). The appropriate input signals to cause the internal clocks to go to a high state must be received during a synchronous preset. Appropriate setup and hold times must be met, as shown in the switching waveform diagram.

An individual asynchronous reset line is provided for each of the 20 flip-flops. Both master and slave halves of the flip-flops are reset when the input signals received force the internal resets high.

25. Software Support

All family members of the ATF750C(L) can be designed with Atmel®-WinCUPL.

Additionally, the ATF750C may be programmed to perform the ATV750(L) functional subset (no T-type flip-flops, pin clocking or D/T2 feedback) using the ATV750 JEDEC file. In this case, the ATF750C becomes a direct replacement or speed upgrade for the ATV750. The ATF750C is a direct replacement for the ATV750(L) and the ATV750B(L).

26. Software Compiler Mode Selection

Table 26-1. Software Compiler Mode Selection

| Device | Atmel - WinCupL Device Mnemonic | Pin-keeper |
|--------------|---------------------------------|---------------------|
| ATF750C-DIP | V750C V750CPPK | Disabled Enabled |
| ATF750C-PLCC | V750LCC V750CPPKLCC | Disabled Enabled |

27. Third Party Programmer Support

Table 27-1. Third Party Programmer Support

| Device | Description |
|-----------------|---|
| ATF750C (V750) | V750 Cross-programming. JEDEC file compatible with standard V750 JEDEC file (total fuses in JEDEC file = 14394). The Programmer will automatically program "0"s into the User Row (UES), and disable the Pin-keeper features. The Fuse Checksum will be the same as the old ATV750/L file. This device type is recommended for customers that are directly migrating from an ATV750/L device to an ATF750C/CL device. |
| ATF750C (V750B) | V750B Cross-programming. JEDEC file compatible with standard V750B JEDEC file (total fuses in JEDEC file = 14435). The Programmer will automatically program "0"s into the User Row (UES), and disable the Pin-keeper feature. The Fuse Checksum will be the same as the old ATV750B/BL file. This device type is recommended for customers that are directly migrating from an ATV750B/BL device to an ATF750C/CL device. |
| ATF750C | Programming of User Row (UES) bits supported and Pin-keeper bit is user-programmable. (Total fuses in JEDEC file = 14504). This is the default device type and is recommended for users that have re-compiled their source design files to specifically target the ATF750C device. |

Note: 1. The ATF750C has 14,504 JEDEC fuses.

28. Security Fuse Usage

A single fuse is provided to prevent unauthorized copying of the ATF750C(L) fuse patterns. Once the security fuse is programmed, all fuses will appear programmed during verify.

The security fuse should be programmed last, as its effect is immediate.

29. Preload of Registered Outputs

The ATF750C(L)'s registers are provided with circuitry to allow loading of each register asynchronously with either a high or a low. This feature will simplify testing since any state can be forced into the registers to control test sequencing. A V_{IH} level on the I/O pin will force the register high; a V_{IL} will force it low, independent of the output polarity. The PRELOAD state is entered by placing a 10.25V to 10.75V signal on pin 8 on DIPs, and lead 10 on SMDs. When the clock term is pulsed high, the data on the I/O pins is placed into the register chosen by the select pin



| Level Forced on Registered Output Pin during Preload Cycle | Select Pin State | Register #0 State after Cycle | Register #1 State after Cycle |
|--|------------------|-------------------------------|-------------------------------|
| V_{IH} | Low | High | X |
| V_{IL} | Low | Low | X |
| V_{IH} | High | X | High |
| V_{IL} | High | X | Low |

ATF750C SUPPLY CURRENT VS. SUPPLY VOLTAGE ($T_A = 25^\circ\text{C}$)

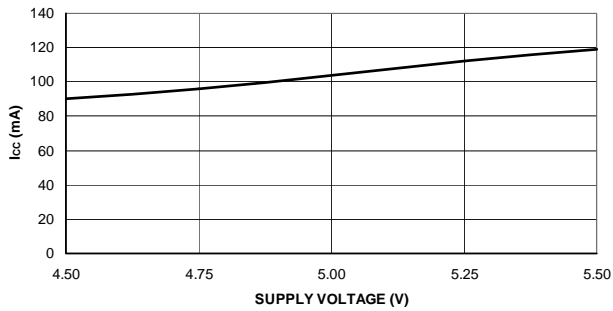

ATF750CL SUPPLY CURRENT VS. SUPPLY VOLTAGE ($T_A = 25^\circ\text{C}$)

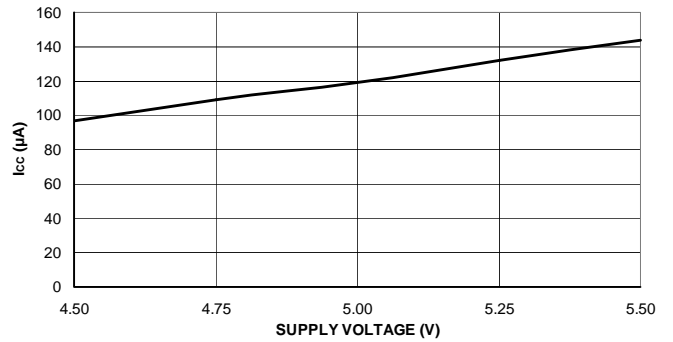

SUPPLY CURRENT VS. FREQUENCY STANDARD POWER ($T_A = 25^\circ\text{C}$)

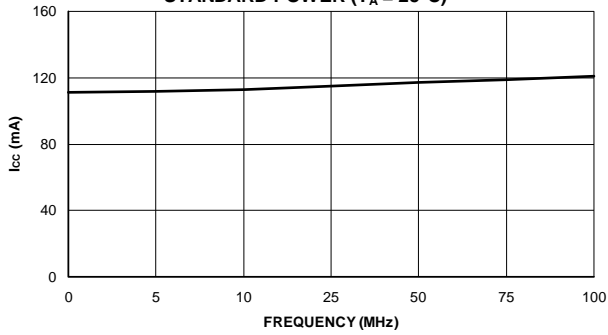

SUPPLY CURRENT VS. FREQUENCY LOW-POWER ("L") VERSION ($T_A = 25^\circ\text{C}$)

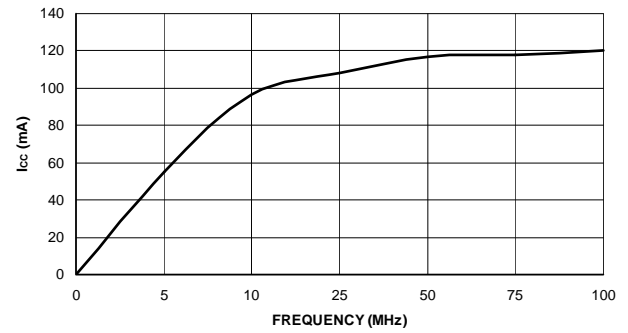

ATF750C/CL OUTPUT SOURCE CURRENT VS. SUPPLY VOLTAGE ($V_{OH} = 2.4\text{V}$)

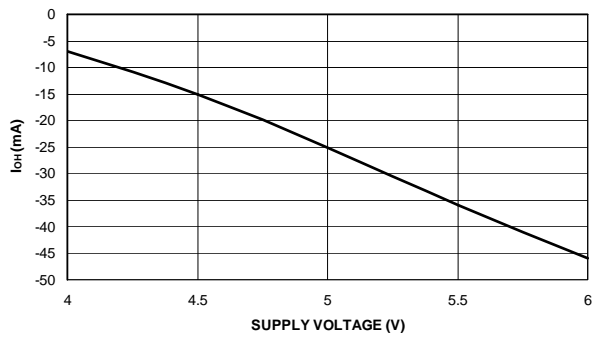

ATF750C/CL OUTPUT SOURCE CURRENT VS. OUTPUT VOLTAGE ($V_{CC} = 5\text{V}$, $T_A = 25^\circ\text{C}$)

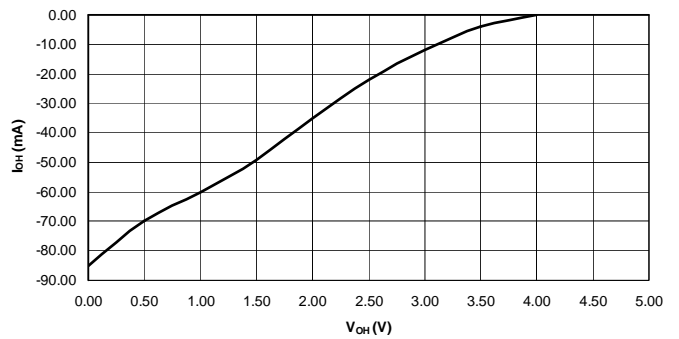

**ATF750C/CL OUTPUT SINK CURRENT
VS. SUPPLY VOLTAGE ($V_{OL} = 0.5V$)**

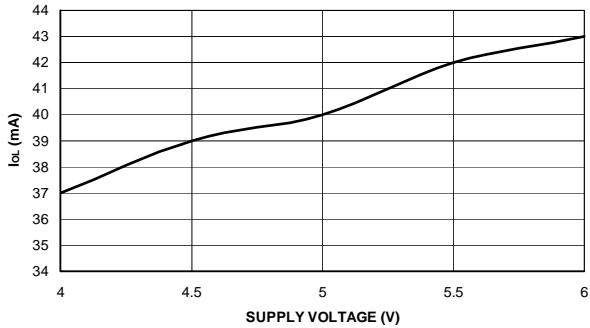

**ATF750C/CL OUTPUT SINK CURRENT
VS. OUTPUT VOLTAGE ($V_{CC} = 5V, T_A = 25^\circ C$)**

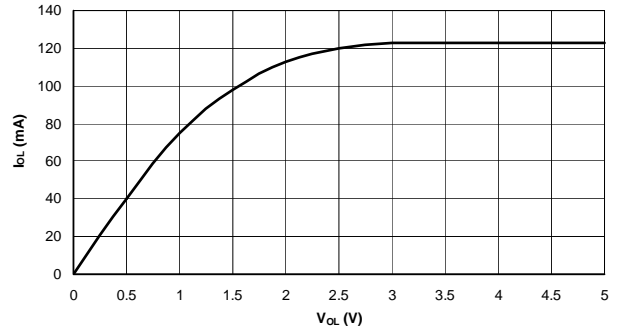

**ATF750C/CL OUTPUT SINK CURRENT
VS. OUTPUT VOLTAGE ($V_{CC} = 5V, T_A = 25^\circ C$)**

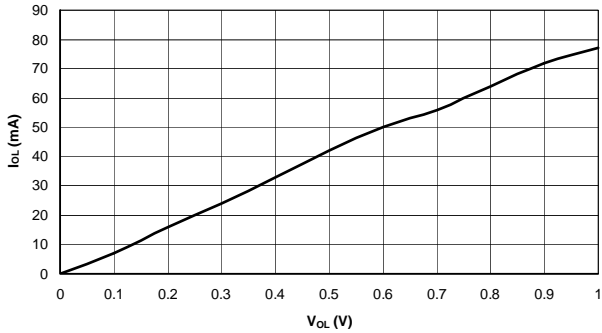

**ATF750C/CL INPUT CURRENT VS. INPUT VOLTAGE
($V_{CC} = 5V, T_A = 25^\circ C$)**

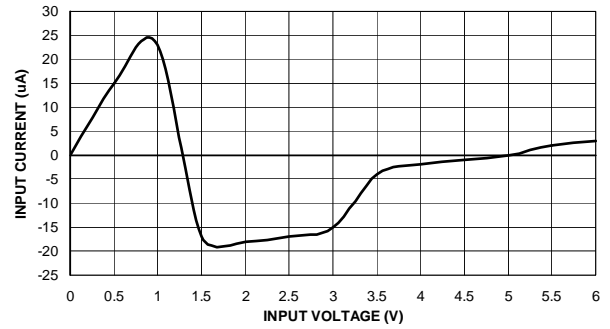

**ATF750C/CL INPUT CURRENT VS. INPUT VOLTAGE
($V_{CC} = 5V, T_A = 25^\circ C$)
WITHOUT PIN-KEEPER**

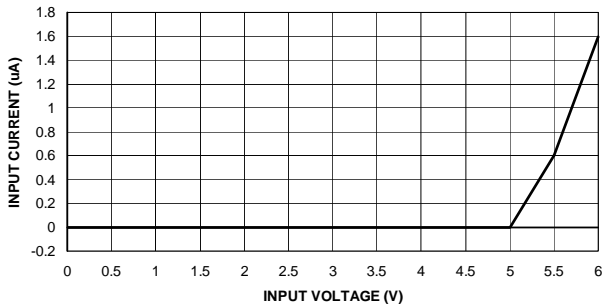

**ATF750C/CL INPUT CLAMP CURRENT
VS. INPUT VOLTAGE ($V_{CC} = 5V, T_A = 35^\circ C$)**

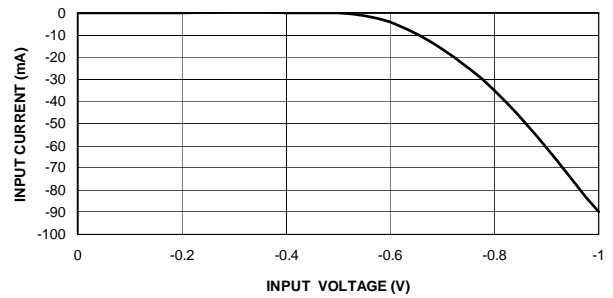

30. ATF750C(L) Military Ordering Information

| t_{PD} (ns) | t_{COS} (ns) | Ext. f_{MAXS} (MHz) | Ordering Code | Package | Operation Range |
|------------------|-------------------|-----------------------------|------------------|---------|--|
| 10 | 7 | 83 | ATF750C-10GM/883 | 24D3 | Military/883 (-55° C to 125° C) Class B, Fully Compliant |
| | | | ATF750C-10NM/883 | 28L | |
| | | | 5962-0720101MLA | 24D3 | |
| | | | 5962-0720101M3A | 28L | |
| 15 | 10 | 55 | ATF750C-15GM/883 | 24D3 | |
| | | | ATF750C-15NM/883 | 28L | |
| | | | 5962-0720102MLA | 24D3 | |
| | | | 5962-0720102M3A | 28L | |

Note: 1. Special order only: TSSOP package requires special thermal management.

31. ATF750C(L) Green Package Options (Pb/Halide-free/RoHS Compliant)

| t_{PD} (ns) | t_{COS} (ns) | Ext. f_{MAXS} (MHz) | Ordering Code | Package | Operation Range |
|------------------|-------------------|-----------------------------|---------------|---------|---------------------------------|
| 7.5 | 6.5 | 95 | ATF750C-7JX | 28J | Commercial (0° C to 70° C) |
| | | | ATF750C-7PX | 24P3 | |
| | | | ATF750C-7SX | 24S | |
| 10 | 7 | 83 | ATF750C-10JU | 28J | Industrial (-40° C to 85° C) |
| | | | ATF750C-10PU | 24P3 | |
| | | | ATF750C-10SU | 24S | |
| | | | ATF750C-10XU | 24X | |
| 15 | 10 | 44 | ATF750CL-15JU | 28J | Industrial (-40° C to 85° C) |
| | | | ATF750CL-15PU | 24P3 | |
| | | | ATF750CL-15SU | 24S | |
| | | | ATF750CL-15XU | 24X | |

32. Using “C” Product for Industrial

To use commercial product for industrial ranges, down-grade one speed grade from the Industrial to the Commercial device (7 ns “X” = 10 ns “U”) and de-rate power by 30%.

| Package Type | |
|--------------------------|---|
| 24D3 | 24-lead, 0.300" Wide, Non-windowed Ceramic Dual Inline Package (CerDIP) |
| 28J | 28-lead, Plastic J-leaded Chip Carrier (PLCC) |
| 28L | 28-pad, Non-Windowed Ceramic Leadless Chip Carrier (LCC) |
| 24P3 | 24-lead, 0.300" Wide, Plastic Dual Inline Package (PDIP) |
| 24S | 24-lead, 0.300" Wide, Plastic Gull Wing Small Outline (SOIC) |
| 24X⁽¹⁾ | 24-lead, 0.173" Wide, Thin Shrink Small Outline (TSSOP) |

Note: 1. Special order only: TSSOP package requires special thermal management.

33. Packaging Information

33.1 24D3 – CerDIP

Dimensions in Millimeters and (Inches).
 Controlling dimension: Inches.
 MIL-STD 1835 D-9 Config A (Glass Sealed)

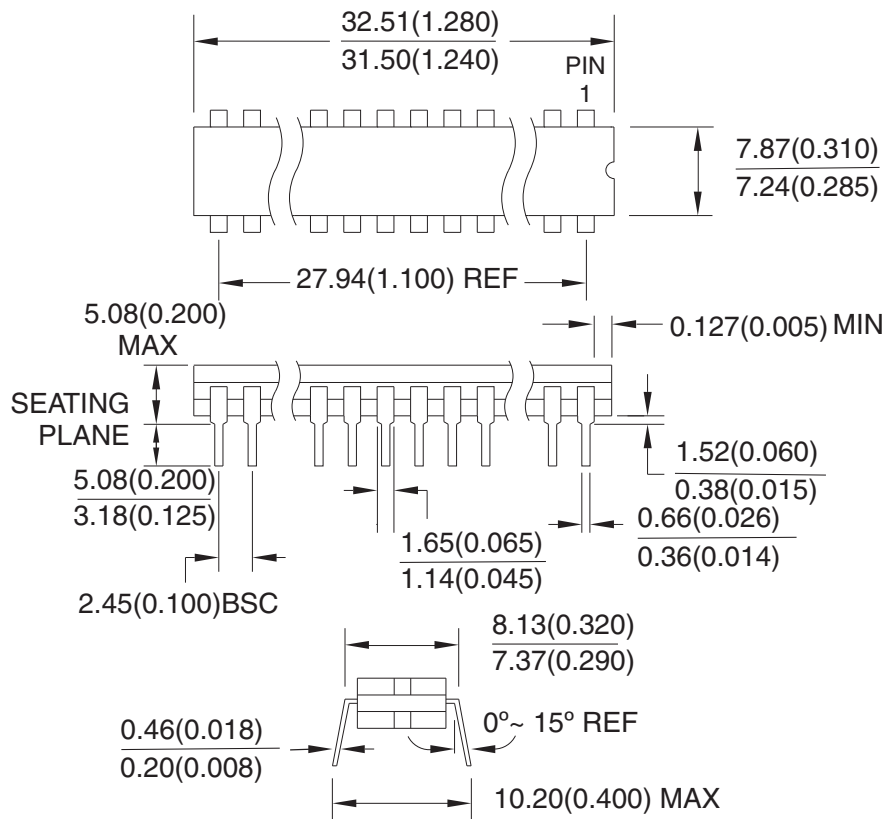

10/21/03



2325 Orchard Parkway
 San Jose, CA 95131

TITLE

24D3, 24-lead, 0.300" Wide. Non-windowed, Ceramic
 Dual Inline Package (Cerdip)

DRAWING NO.

24D3

REV.

B

33.2 28J – PLCC

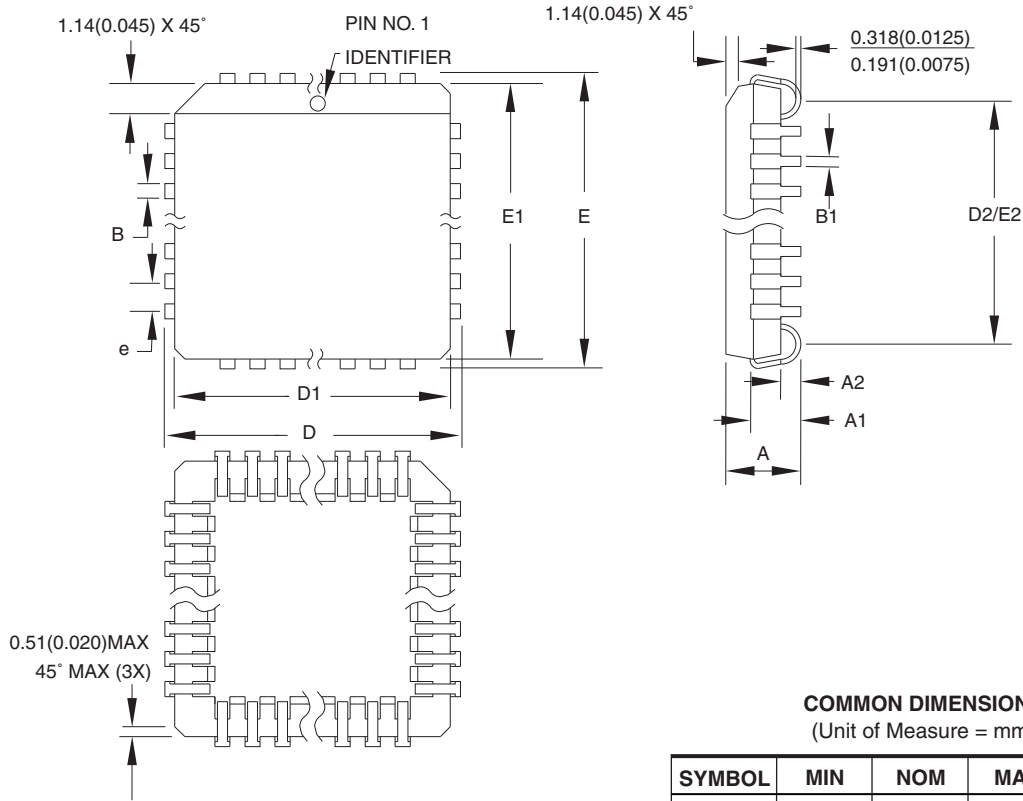

COMMON DIMENSIONS
(Unit of Measure = mm)

| SYMBOL | MIN | NOM | MAX | NOTE |
|--------|-----------|-----|--------|--------|
| A | 4.191 | – | 4.572 | |
| A1 | 2.286 | – | 3.048 | |
| A2 | 0.508 | – | – | |
| D | 12.319 | – | 12.573 | |
| D1 | 11.430 | – | 11.582 | Note 2 |
| E | 12.319 | – | 12.573 | |
| E1 | 11.430 | – | 11.582 | Note 2 |
| D2/E2 | 9.906 | – | 10.922 | |
| B | 0.660 | – | 0.813 | |
| B1 | 0.330 | – | 0.533 | |
| e | 1.270 TYP | | | |

- Notes:
1. This package conforms to JEDEC reference MS-018, Variation AB.
 2. Dimensions D1 and E1 do not include mold protrusion. Allowable protrusion is .010"(0.254 mm) per side. Dimension D1 and E1 include mold mismatch and are measured at the extreme material condition at the upper or lower parting line.
 3. Lead coplanarity is 0.004" (0.102 mm) maximum.

10/04/01



2325 Orchard Parkway
San Jose, CA 95131

TITLE

28J, 28-lead, Plastic J-leaded Chip Carrier (PLCC)

DRAWING NO.

28J

REV.

B



33.3 28L – LCC

Dimensions in Millimeters and (Inches).
 Controlling dimension: Inches.
 MIL-STD 1835 C-4



10/21/03



2325 Orchard Parkway
 San Jose, CA 95131

TITLE

28L, 28-pad, Non-windowed, Ceramic Lid, Leadless Chip Carrier (LCC)

DRAWING NO.

28L

REV.

B

33.4 24P3 – PDIP



COMMON DIMENSIONS
(Unit of Measure = mm)

| SYMBOL | MIN | NOM | MAX | NOTE |
|--------|-----------|-----|--------|--------|
| A | – | – | 5.334 | |
| A1 | 0.381 | – | – | |
| D | 31.623 | – | 32.131 | Note 2 |
| E | 7.620 | – | 8.255 | |
| E1 | 6.096 | – | 7.112 | Note 2 |
| B | 0.356 | – | 0.559 | |
| B1 | 1.270 | – | 1.651 | |
| L | 2.921 | – | 3.810 | |
| C | 0.203 | – | 0.356 | |
| eB | – | – | 10.922 | |
| eC | 0.000 | – | 1.524 | |
| e | 2.540 TYP | | | |

- Notes:
1. This package conforms to JEDEC reference MS-001, Variation AF.
 2. Dimensions D and E1 do not include mold Flash or Protrusion. Mold Flash or Protrusion shall not exceed 0.25 mm (0.010").

6/1/04



2325 Orchard Parkway
San Jose, CA 95131

TITLE

**24P3, 24-lead (0.300"/7.62 mm Wide) Plastic Dual
Inline Package (PDIP)**

DRAWING NO.

24P3

REV.

D



33.5 24S – SOIC

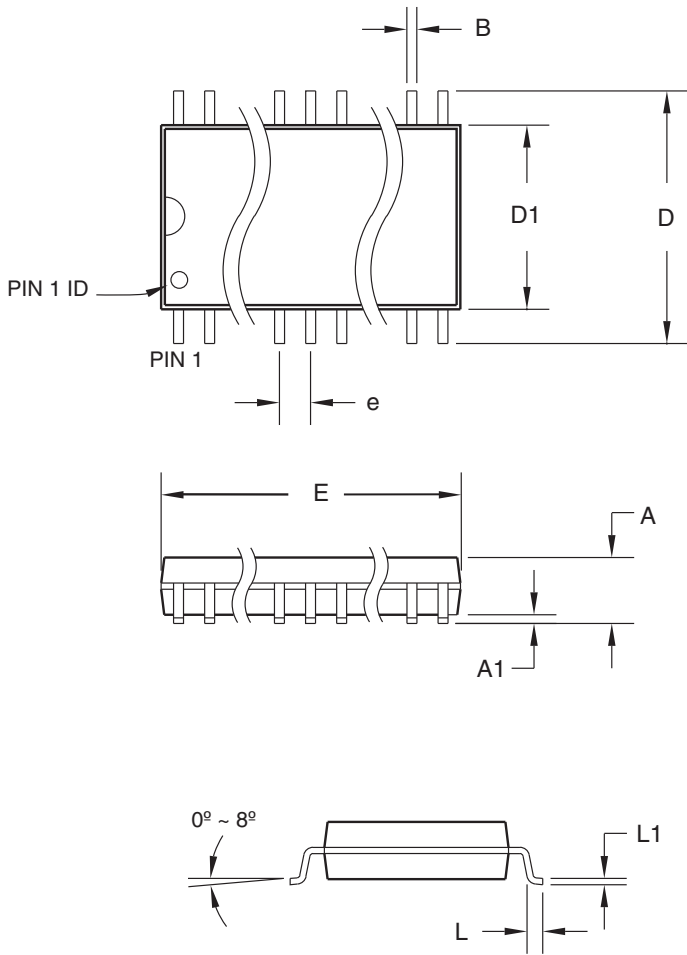

COMMON DIMENSIONS
(Unit of Measure = mm)

| SYMBOL | MIN | NOM | MAX | NOTE |
|--------|----------|-----|-------|------|
| A | – | – | 2.65 | |
| A1 | 0.10 | – | 0.30 | |
| D | 10.00 | – | 10.65 | |
| D1 | 7.40 | – | 7.60 | |
| E | 15.20 | – | 15.60 | |
| B | 0.33 | – | 0.51 | |
| L | 0.40 | – | 1.27 | |
| L1 | 0.23 | – | 0.32 | |
| e | 1.27 BSC | | | |

06/17/2002



2325 Orchard Parkway
San Jose, CA 95131

TITLE

24S, 24-lead (0.300" body) Plastic Gull Wing Small Outline (SOIC)

DRAWING NO.

24S

REV.

B

33.6 24X – TSSOP

Dimensions in Millimeter and (Inches)*
 JEDEC STANDARD MO-153 AD
 Controlling dimension: millimeters

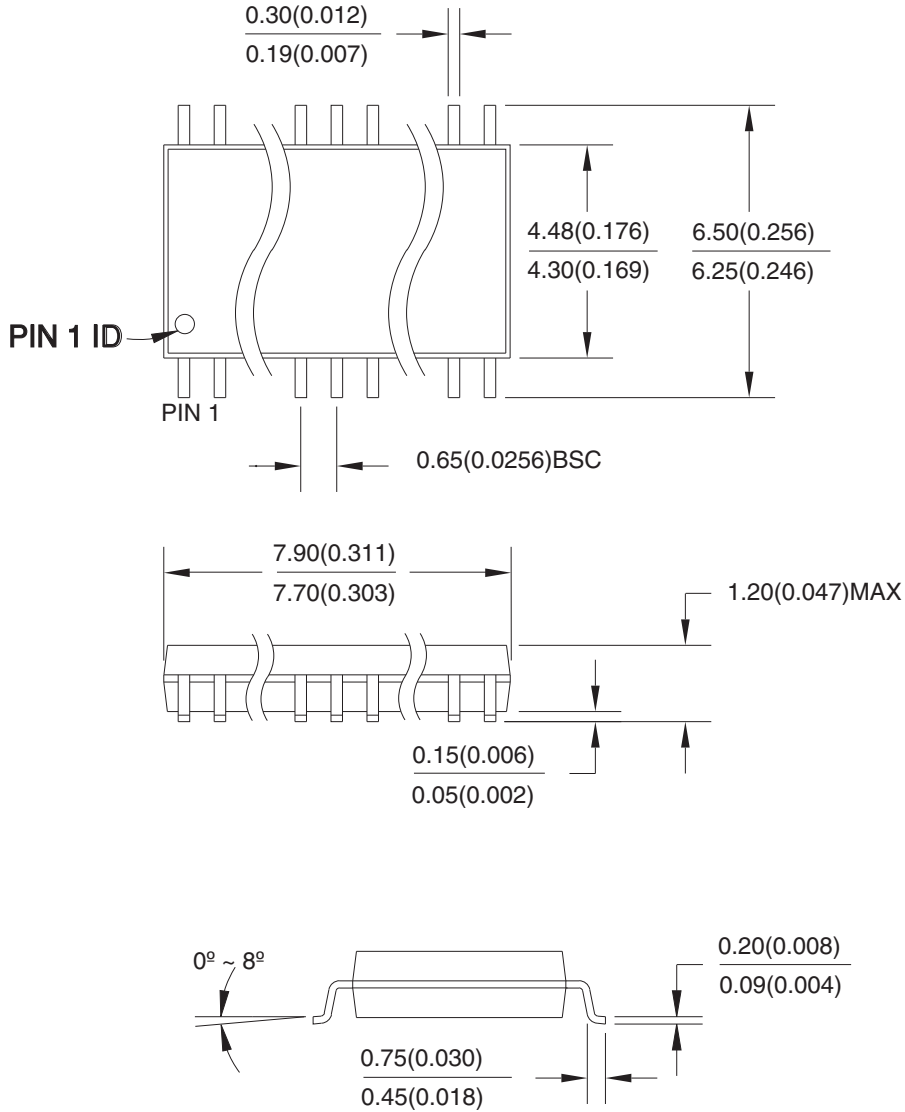

04/11/2001



2325 Orchard Parkway
 San Jose, CA 95131

TITLE

24X, 24-lead (4.4 mm body width) Plastic Thin Shrink Small Outline Package (TSSOP)

DRAWING NO.

24X

REV.

A





34. Revision History

| Revision Level – Release Date | History |
|-------------------------------|--|
| K – July 2007 | Added military-grade devices. Added fully-green RoHS-compliant devices in select speed grades and packages. |
| L – November 2008 | Removed commercial grade leaded package options. |





Headquarters

Atmel Corporation
2325 Orchard Parkway
San Jose, CA 95131
USA
Tel: 1(408) 441-0311
Fax: 1(408) 487-2600

International

Atmel Asia
Unit 1-5 & 16, 19/F
BEA Tower, Millennium City 5
418 Kwun Tong Road
Kwun Tong, Kowloon
Hong Kong
Tel: (852) 2245-6100
Fax: (852) 2722-1369

Atmel Europe
Le Krebs
8, Rue Jean-Pierre Timbaud
BP 309
78054 Saint-Quentin-en-
Yvelines Cedex
France
Tel: (33) 1-30-60-70-00
Fax: (33) 1-30-60-71-11

Atmel Japan
9F, Tonetsu Shinkawa Bldg.
1-24-8 Shinkawa
Chuo-ku, Tokyo 104-0033
Japan
Tel: (81) 3-3523-3551
Fax: (81) 3-3523-7581

Product Contact

Web Site
www.atmel.com

Technical Support
pld@atmel.com

Sales Contact
www.atmel.com/contacts

Literature Requests
www.atmel.com/literature

Disclaimer: The information in this document is provided in connection with Atmel products. No license, express or implied, by estoppel or otherwise, to any intellectual property right is granted by this document or in connection with the sale of Atmel products. **EXCEPT AS SET FORTH IN ATMEL'S TERMS AND CONDITIONS OF SALE LOCATED ON ATMEL'S WEB SITE, ATMEL ASSUMES NO LIABILITY WHATSOEVER AND DISCLAIMS ANY EXPRESS, IMPLIED OR STATUTORY WARRANTY RELATING TO ITS PRODUCTS INCLUDING, BUT NOT LIMITED TO, THE IMPLIED WARRANTY OF MERCHANTABILITY, FITNESS FOR A PARTICULAR PURPOSE, OR NON-INFRINGEMENT. IN NO EVENT SHALL ATMEL BE LIABLE FOR ANY DIRECT, INDIRECT, CONSEQUENTIAL, PUNITIVE, SPECIAL OR INCIDENTAL DAMAGES (INCLUDING, WITHOUT LIMITATION, DAMAGES FOR LOSS OF PROFITS, BUSINESS INTERRUPTION, OR LOSS OF INFORMATION) ARISING OUT OF THE USE OR INABILITY TO USE THIS DOCUMENT, EVEN IF ATMEL HAS BEEN ADVISED OF THE POSSIBILITY OF SUCH DAMAGES.** Atmel makes no representations or warranties with respect to the accuracy or completeness of the contents of this document and reserves the right to make changes to specifications and product descriptions at any time without notice. Atmel does not make any commitment to update the information contained herein. Unless specifically provided otherwise, Atmel products are not suitable for, and shall not be used in, automotive applications. Atmel's products are not intended, authorized, or warranted for use as components in applications intended to support or sustain life.

© 2008 Atmel Corporation. All rights reserved. Atmel®, Atmel logo and combinations thereof, and others are registered trademarks or trademarks of Atmel Corporation or its subsidiaries. Other terms and product names may be trademarks of others.

Mouser Electronics

Authorized Distributor

Click to View Pricing, Inventory, Delivery & Lifecycle Information:

Microchip:

[ATF750C-10JU](#) [ATF750C-10PU](#) [ATF750C-10SU](#) [ATF750C-7JX](#) [ATF750C-7PX](#) [ATF750CL-15JU](#) [ATF750CL-15PU](#)
[ATF750CL-15SU](#) [ATF750CL-15XU](#) [ATF750C-10GM/883](#) [ATF750C-10NM/883](#) [ATF750C-15GM/883](#) [ATF750C-](#)
[15NM/883](#) [ATF750C-7SX](#)

Компания «Life Electronics» занимается поставками электронных компонентов импортного и отечественного производства от производителей и со складов крупных дистрибьюторов Европы, Америки и Азии.

С конца 2013 года компания активно расширяет линейку поставок компонентов по направлению коаксиальный кабель, кварцевые генераторы и конденсаторы (керамические, пленочные, электролитические), за счёт заключения дистрибьюторских договоров

Мы предлагаем:

- Конкурентоспособные цены и скидки постоянным клиентам.
- Специальные условия для постоянных клиентов.
- Подбор аналогов.
- Поставку компонентов в любых объемах, удовлетворяющих вашим потребностям.
- Приемлемые сроки поставки, возможна ускоренная поставка.
- Доставку товара в любую точку России и стран СНГ.
- Комплексную поставку.
- Работу по проектам и поставку образцов.
- Формирование склада под заказчика.
- Сертификаты соответствия на поставляемую продукцию (по желанию клиента).
- Тестирование поставляемой продукции.
- Поставку компонентов, требующих военную и космическую приемку.
- Входной контроль качества.
- Наличие сертификата ISO.

В составе нашей компании организован Конструкторский отдел, призванный помогать разработчикам, и инженерам.

Конструкторский отдел помогает осуществить:

- Регистрацию проекта у производителя компонентов.
- Техническую поддержку проекта.
- Защиту от снятия компонента с производства.
- Оценку стоимости проекта по компонентам.
- Изготовление тестовой платы монтаж и пусконаладочные работы.



Тел: +7 (812) 336 43 04 (многоканальный)
Email: org@lifeelectronics.ru