

REVISIONS				
P.	LTM	DESCRIPTION	DATE	APVD
H5		ADD NEW DASH NUMBER	24APR2014	CZ SZ

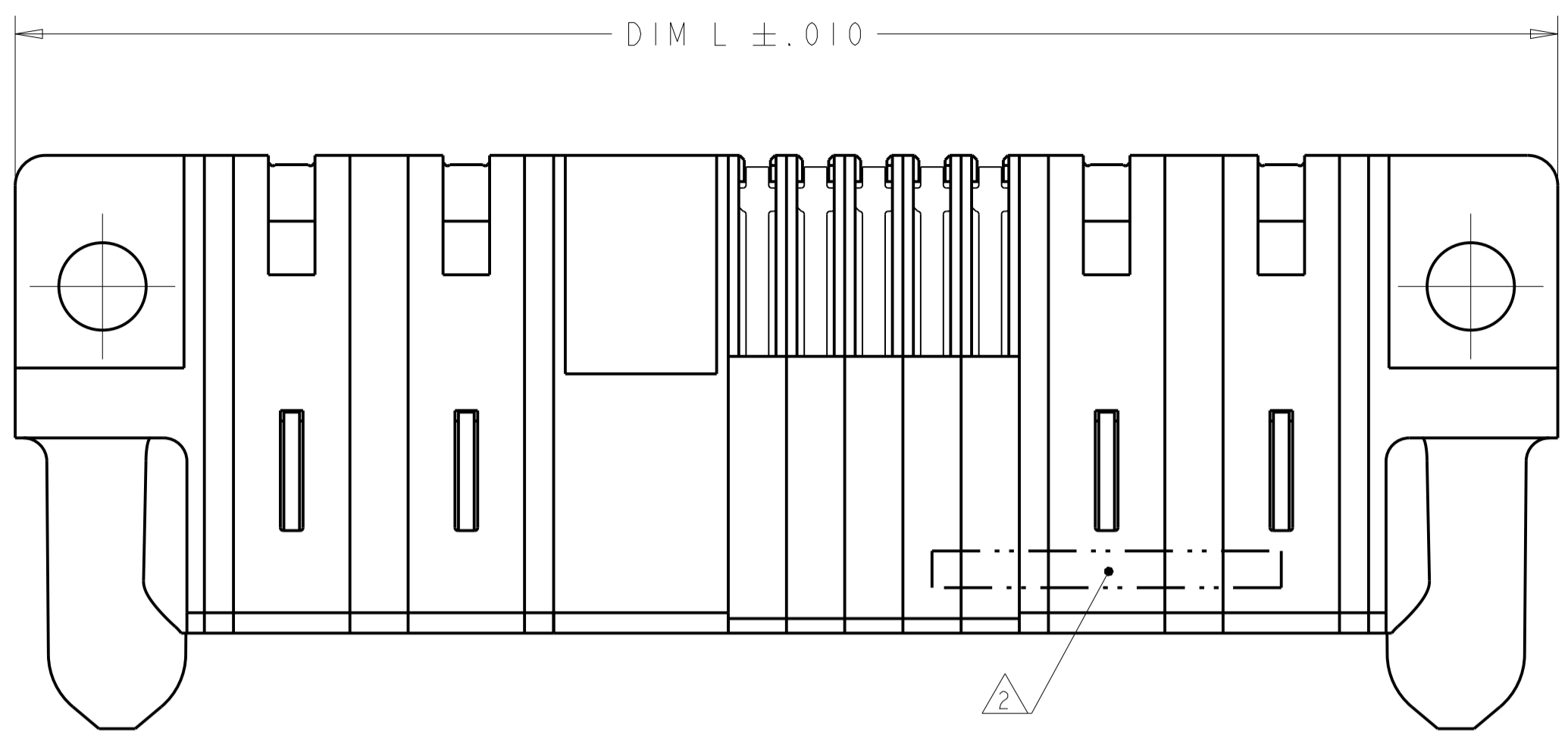

- 1 OPTIONAL CENTER MODULE, WITH .150 THRU HOLE OR HOLD DOWN FEATURE.
- 2 "AMP", PART NUMBER, AND DATE CODE TO BE MARKED IN AREA SHOWN.
- 3 MATERIAL: HOUSING - GLASS FILLED HIGH TEMP THERMO PLASTIC, UL94 V-O, BLACK.  
 SIGNAL CONTACT - HIGH CONDUCTIVITY COPPER ALLOY  
 POWER CONTACT - HIGH CONDUCTIVITY COPPER ALLOY
- 4 CONTACT PLATING: NOBLE METAL PLATING ON CONTACT FUNCTIONAL AREA OF POWER AND SIGNAL CONTACTS
- 5 MECHANICAL CONNECTOR KEEP OUT ZONE.
- 6 DATUM AND BASIC DIMENSIONS ESTABLISHED BY CUSTOMER.
- 7 PCB - ALL HOLE DIAMETERS ARE FINISHED HOLE SIZES.
- 8 PCB - 0.0453 +/- .0010 DRILLED HOLES PLATED WITH .0003 MIN. Sn OVER .001 TO .003 CU PLATING TO ACHIEVE A .040±.003 HOLE.
- 9 VARIABLE DIMENSION SHOW ON VIEW (SHEET 3).

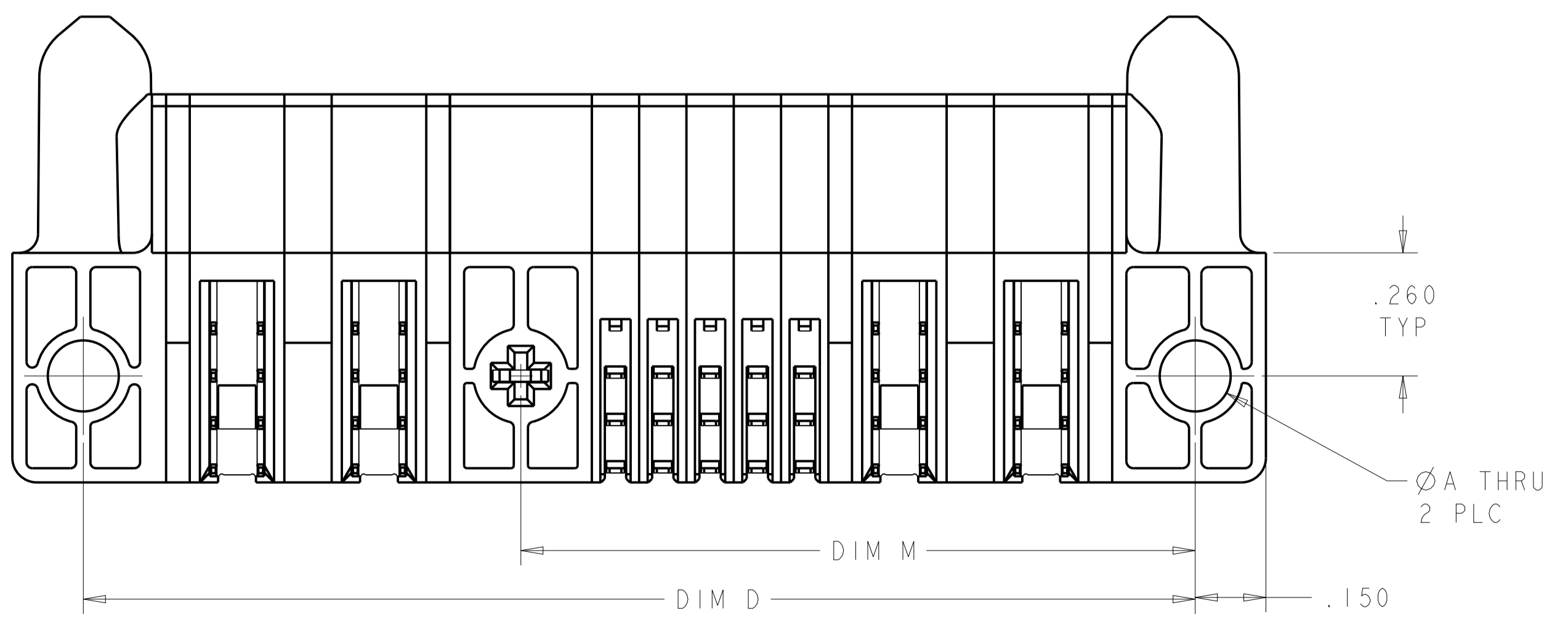
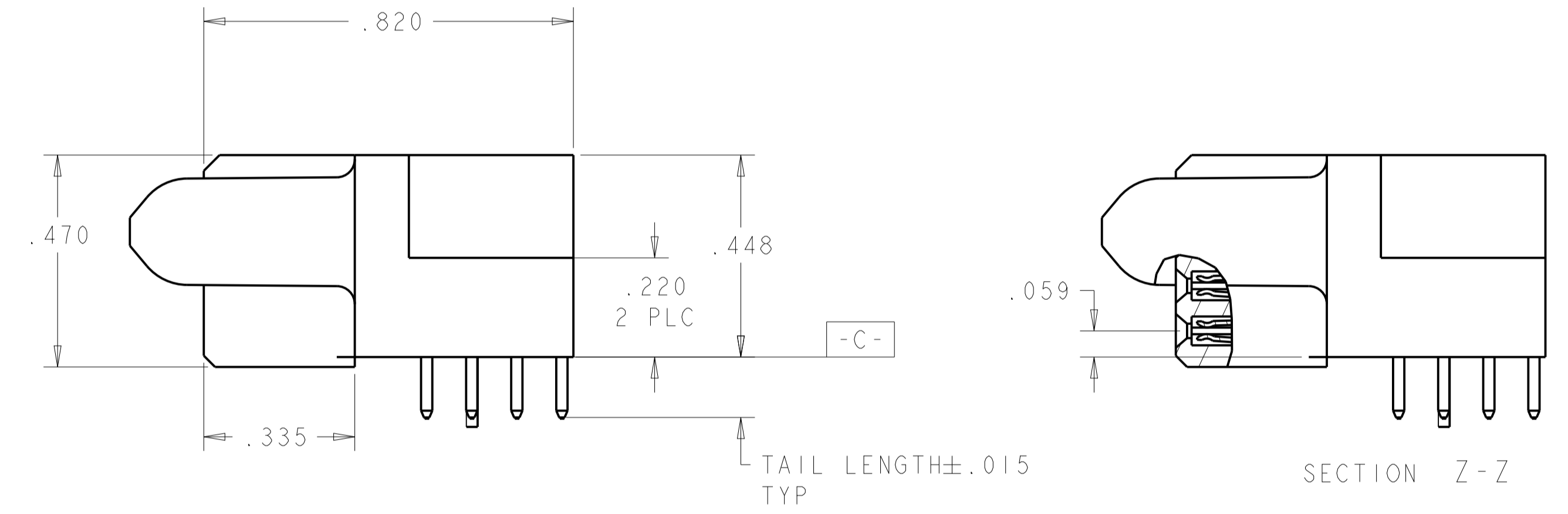
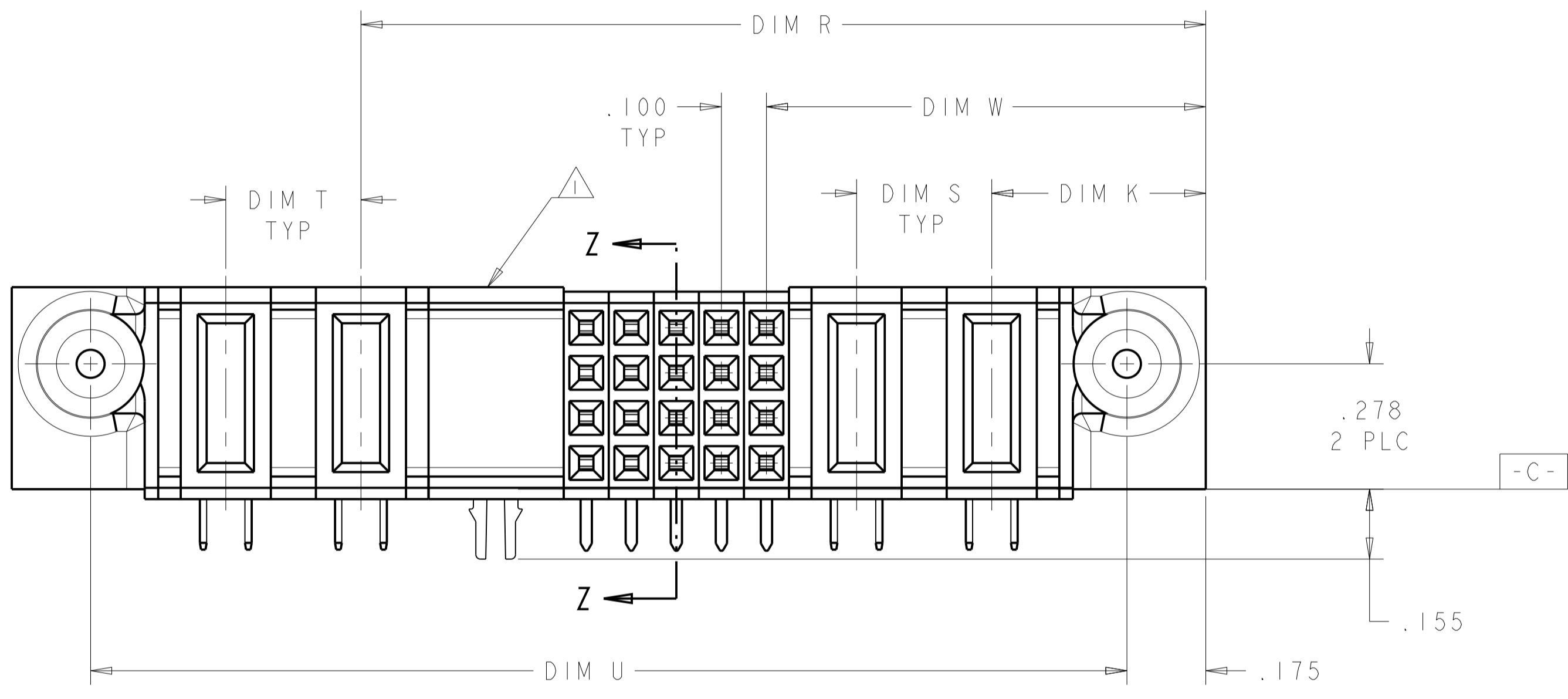

H5	DIM A	DIM T	DIM S	DIM U	DIM R	DIM W	DIM D	DIM M	DIM L	DIM K	DESCRIPTION	PART NUMBER
	.122	-	.250	2.750	2.650	1.375	2.800	-	3.100	.450	4P + 48S + 1P	1-6450360-6
	.122	-	.200	2.700	2.600	1.425	2.750	-	3.050	.450	5P+44S+1P	1-6450360-5
	.150	.200	.200	1.600	1.300	.825	1.650	-	1.950	.450	2HDP + 16S + 2HDP	1-6450360-4
	.150	.200	.200	2.400	2.100	.825	2.450	-	2.750	.450	2P + 48S + 2P	1-6450360-3
	.150	-	-	1.200	1.100	.625	1.250	-	1.550	.450	1P + 16S + 1P	1-6450360-2
	.150	9	.250	2.550	1.550	.875	2.600	-	2.900	.450	2P + 24S + 1P + 3ACP	1-6450360-1
	.150	.200	9	2.750	1.450	1.175	2.800	-	3.100	.450	3P + 8S + 7HDP	1-6450360-0
	.150	.300	.250	3.200	2.475	1.875	3.250	-	3.550	.450	6P + 16S + 3ACP	6450360-9
	.150	.250	.250	1.600	1.250	.925	1.650	-	1.950	.450	2P + 8S + 2P	6450360-8
	.150	.250	.250	1.600	1.250	.875	1.650	-	1.950	.450	2P + 12S + 2P	6450360-7
	.150	.300	.300	2.000	1.575	.975	2.050	-	2.350	.475	2P + 20S + 2P	6450360-1
	DIM A	DIM T	DIM S	DIM U	DIM R	DIM W	DIM D	DIM M	DIM L	DIM K	DESCRIPTION	PART NUMBER

THIS DRAWING IS A CONTROLLED DOCUMENT. DWN: R. GRZYBOWSKI, DBAPROS  
 CHK: M. PERCHERKE, DBAPROS  
 APVD: M. PERCHERKE

DIMENSIONS: INCHES  
 TOLERANCES UNLESS OTHERWISE SPECIFIED:  
 0 PLC ±.01  
 1 PLC ±.01  
 2 PLC ±.01  
 3 PLC ±.005  
 4 PLC ±.002  
 ANGLES ±.020

MATERIAL: 3  
 FINISH: 4

STE TE Connectivity  
 NAME: RIGHT ANGLE RECEPTACLE ASSEMBLY WITH GUIDES MULTI-BEAM XL  
 PRODUCT SPEC: 108-1973  
 APPLICATION SPEC: 114-13038  
 WEIGHT: -  
 CUSTOMER DRAWING

SCALE: 4:1 SHEET 1 OF 6 REV: H5

REVISIONS				
REV	DATE	BY	CHK	APPV
-	-	-	-	-
-	-	-	-	-

PART NUMBER	ROWS	POWER		SIGNAL					POWER	
		P4	P3	5	4	3	2	1	P2	P1
6450360-1	D C B A	RA	RA	H	H	H	H	H	RA	RA
				G	G	G	G	G		
				F	F	F	F	F		
		E	E	E	E	E	E			
2P + 20S + 2P										

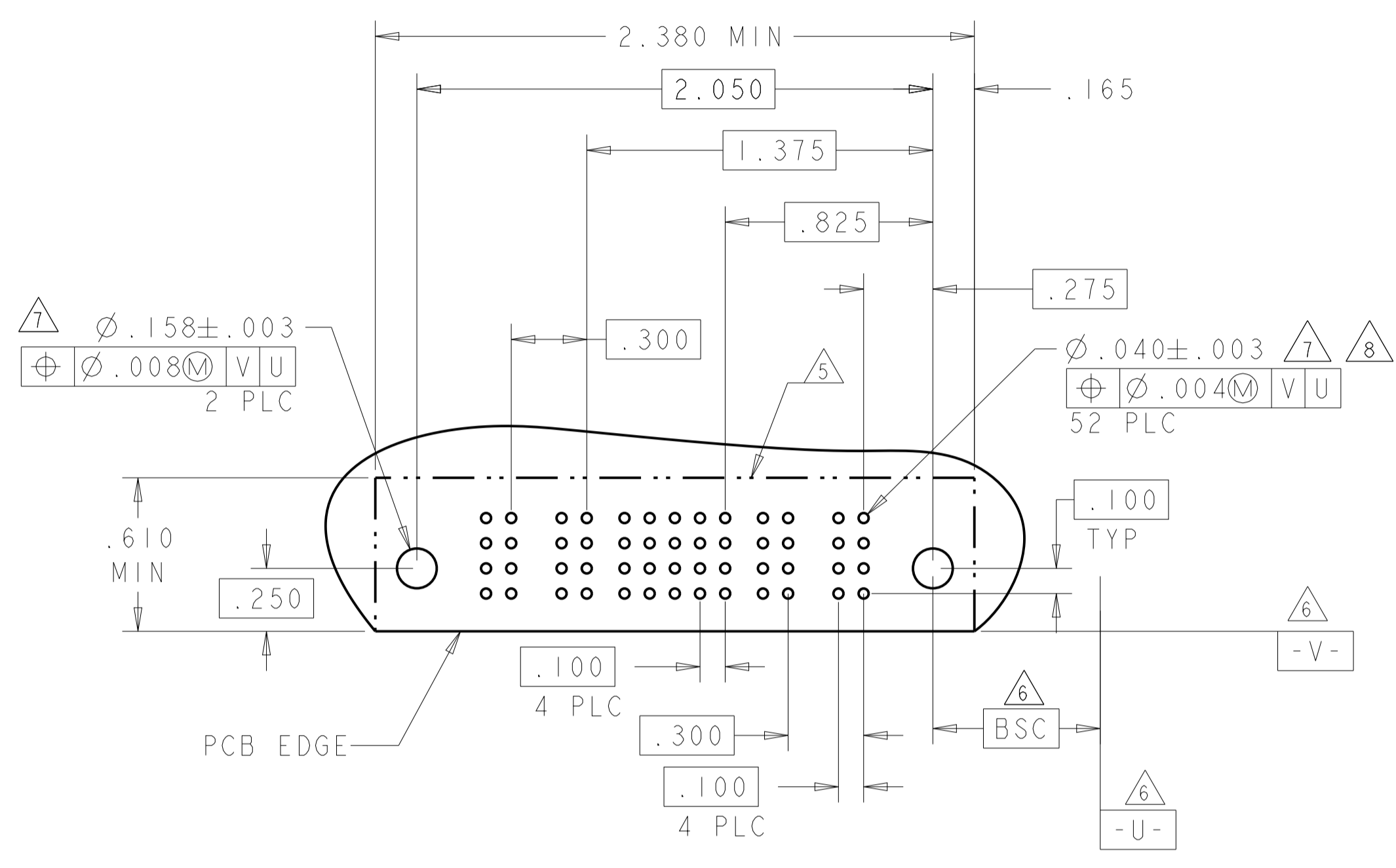

PART NUMBER	ROWS	POWER		SIGNAL		POWER	
		P4	P3	2	1	P2	P1
6450360-8	D C B A	RM	RM	H	H	RM	RM
				G	G		
				F	F		
		E	E				
2P + 8S + 2P							

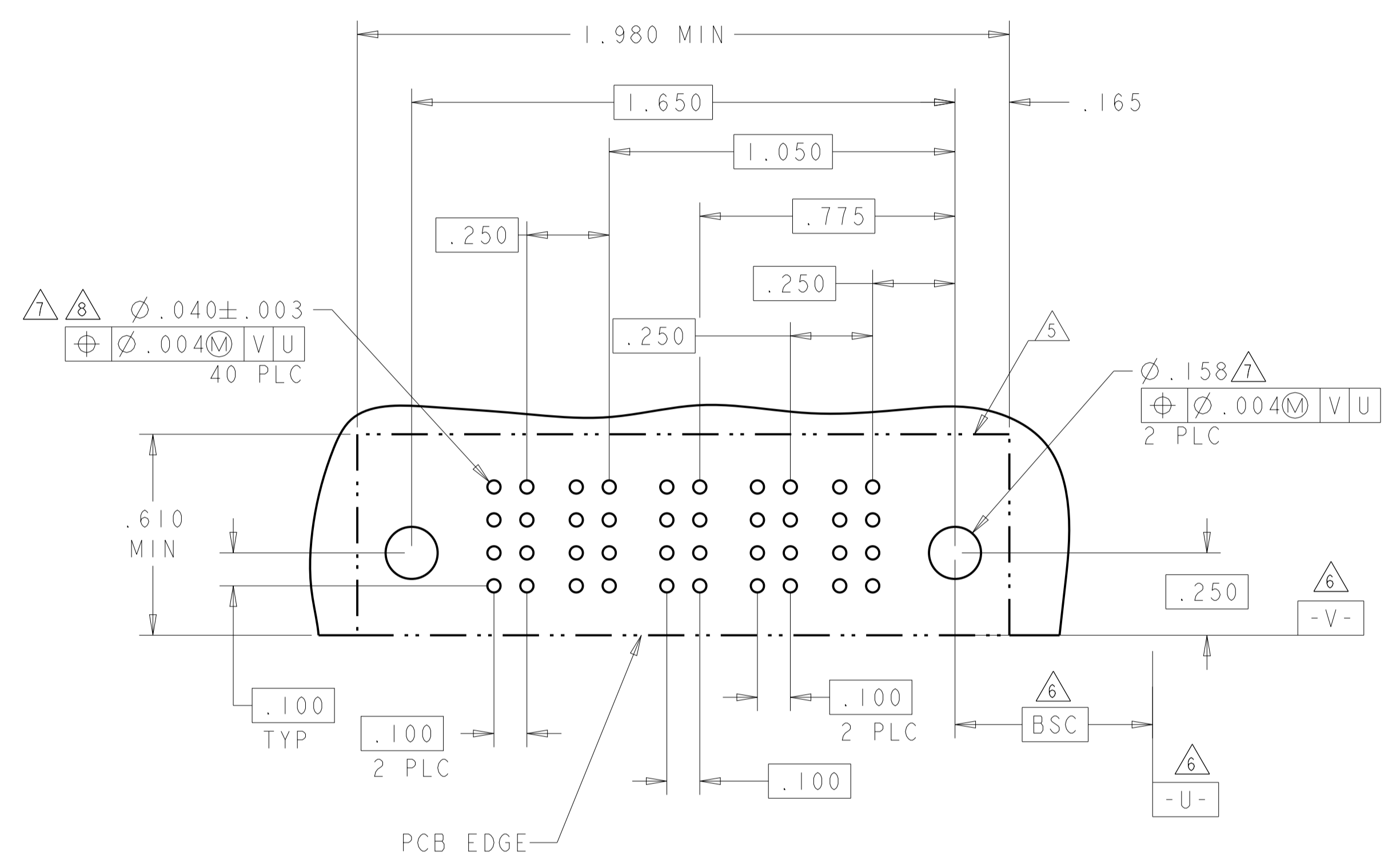

PART NUMBER	ROWS	POWER			SIGNAL				POWER					
		P9	P8	P7	4	3	2	1	P6	P5	P4	P3	P2	P1
6450360-9	D C B A	RM	RM	RM	H	H	H	H	RM	RM	RM	RM	RM	RM
					G	G	G	G						
					F	F	F	F						
					E	E	E	E						
6P + 16S + 3ACP														

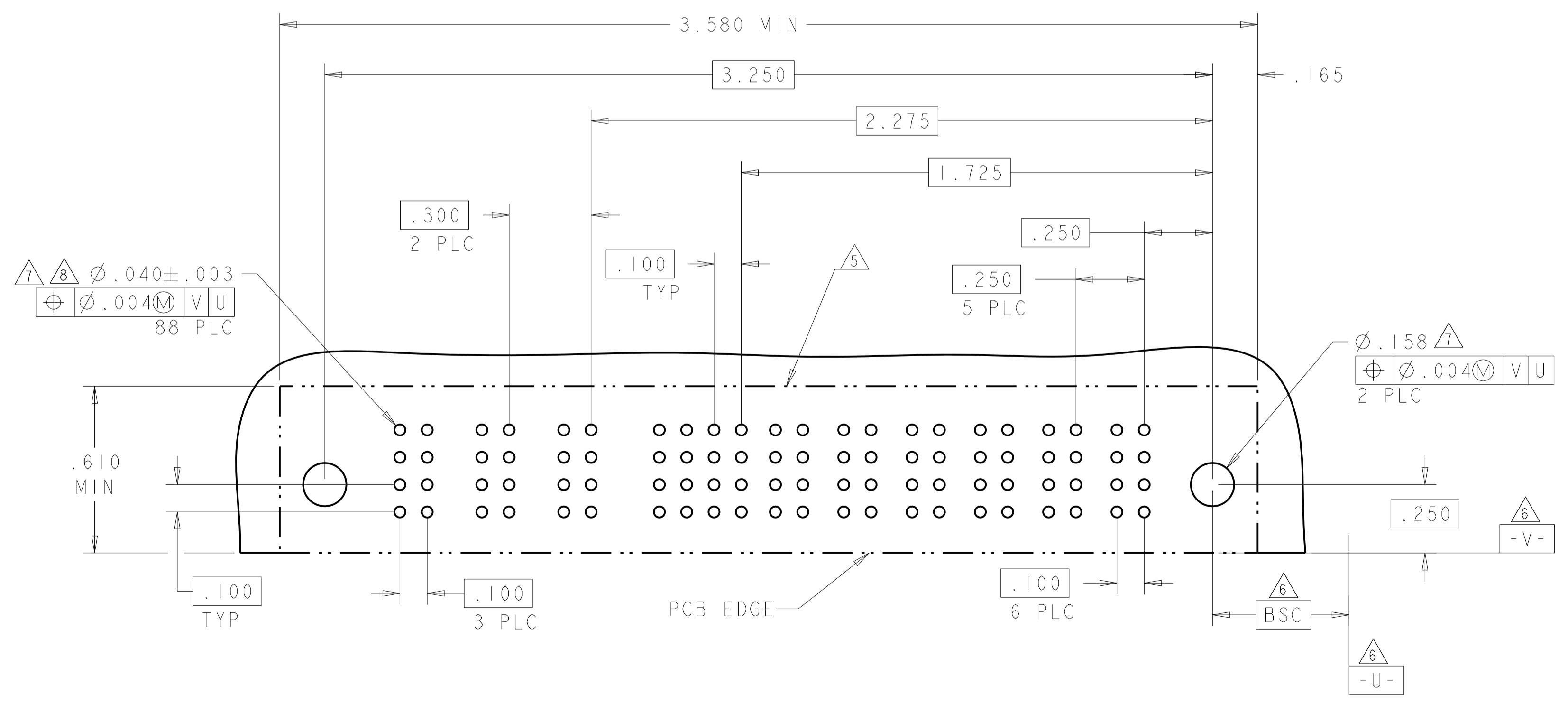

CODE	TAIL LENGTH	DESCRIPTION
RB	.090	MFBL
RM	.135	STD
RA	.135	MFBL

POWER CONTACT

CODE	TAIL LENGTH	ROW
L	.090	D
K	.090	C
J	.090	B
I	.090	A
H	.135	D
G	.135	C
F	.135	B
E	.135	A

SIGNAL CONTACT

THIS DRAWING IS A CONTROLLED DOCUMENT.

DIMENSIONS: INCHES	TOLERANCES UNLESS OTHERWISE SPECIFIED:	OWN: R. GRZYBOWSKI	OBAPROS
	0 PLC ±	CHK: M. PERCHERKE	OBAPROS
	1 PLC ±.01	APVD: M. PERCHERKE	
	2 PLC ±.01	NAME: RIGHT ANGLE RECEPTACLE ASSEMBLY WITH GUIDES MULTI-BEAM XL	
	3 PLC ±.005	PRODUCT SPEC: 108-1973	
4 PLC ±.002	APPLICATION SPEC: 114-13038	SIZE: CAGE CODE: DRAWING NO: A100779	RESTRICTED TO: C=6450360
ANGLES ±.020	FINISH: *	WEIGHT: -	
MATERIAL: -		CUSTOMER DRAWING	SCALE: 4:1 SHEET 2 OF 6 REV: H5

REVISIONS				
P. LTR.	DESCRIPTION	DATE	OWN	APVD
-	SEE SHEET 1	-	-	-

PART NUMBER	ROWS	POWER							SIGNAL		POWER		
		P10	P9	P8	P7	P6	P5	P4	2	1	P3	P2	P1
1-6450360-0	D C B A	RM	RM	RM	RM	RM	RM	RM	H	H	RM	RM	RM
									G	G			
									F	F			
									E	E			

PART NUMBER	ROWS	POWER				SIGNAL					POWER		
		P6	P5	P4	P3	6	5	4	3	2	1	P2	P1
1-6450360-1	D C B A	RM	RM	RM	RM	H	H	H	H	H	H	RM	RM
						G	G	G	G	G	G		
						F	F	F	F	F	F		
						E	E	E	E	E	E		

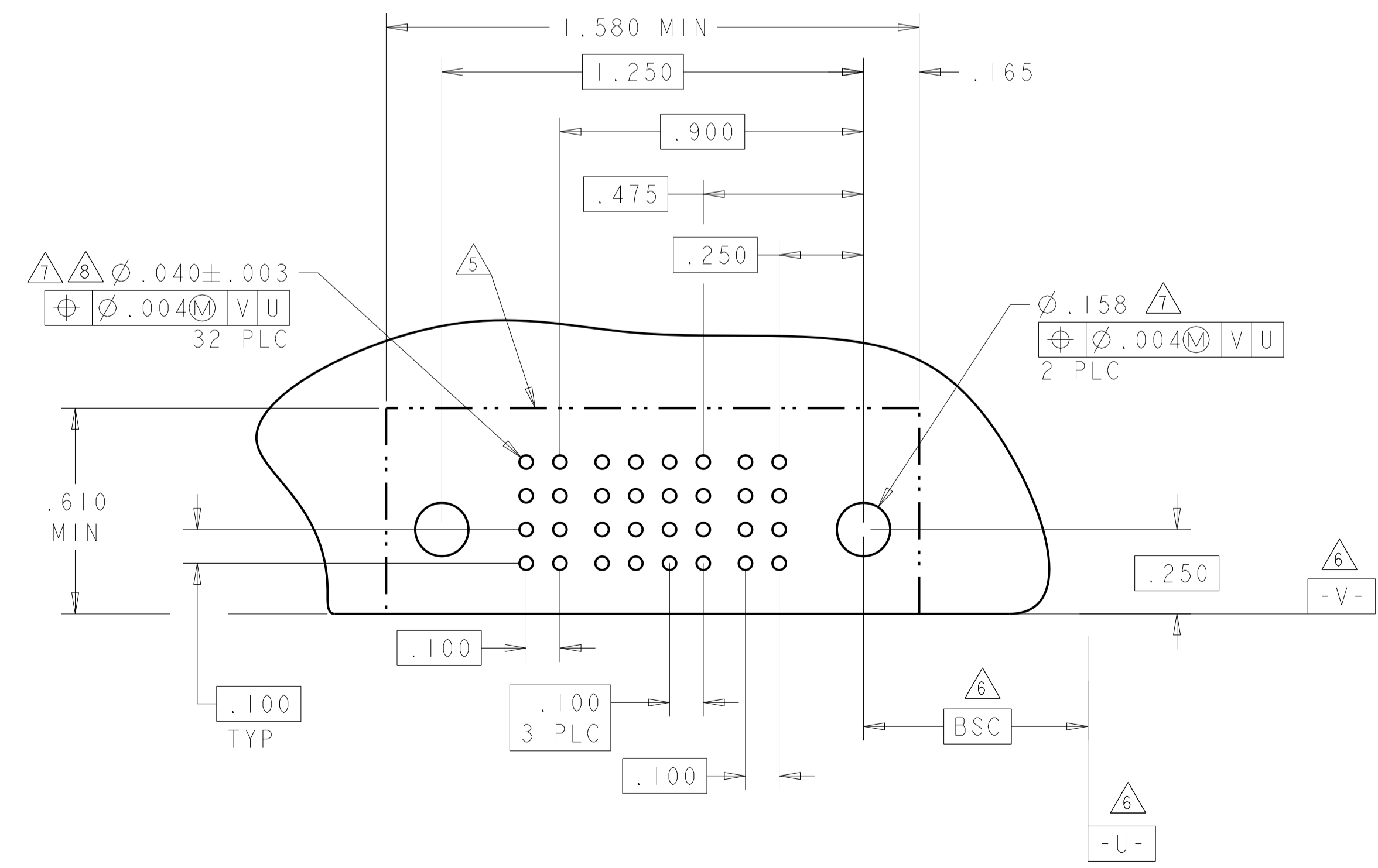
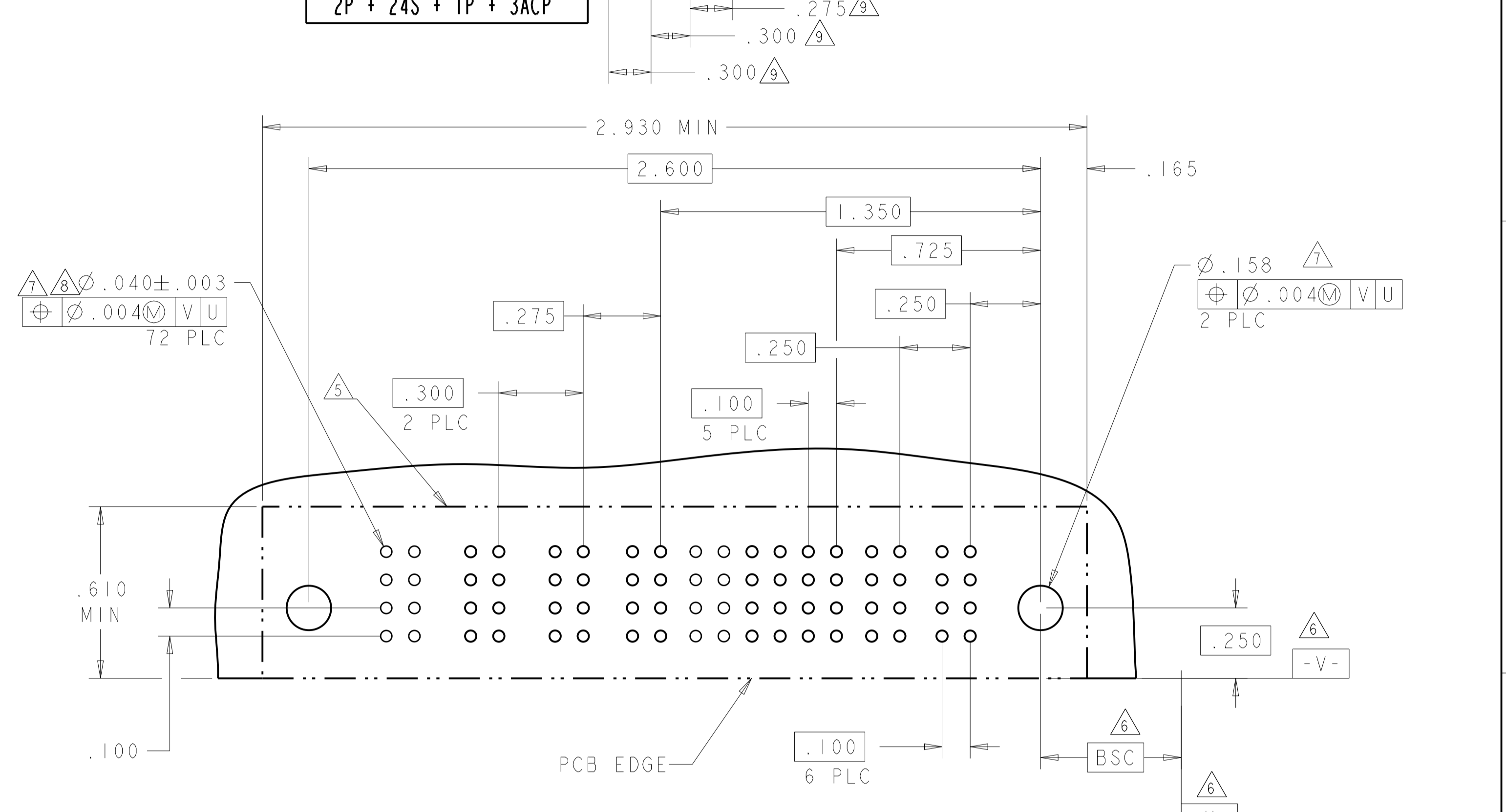
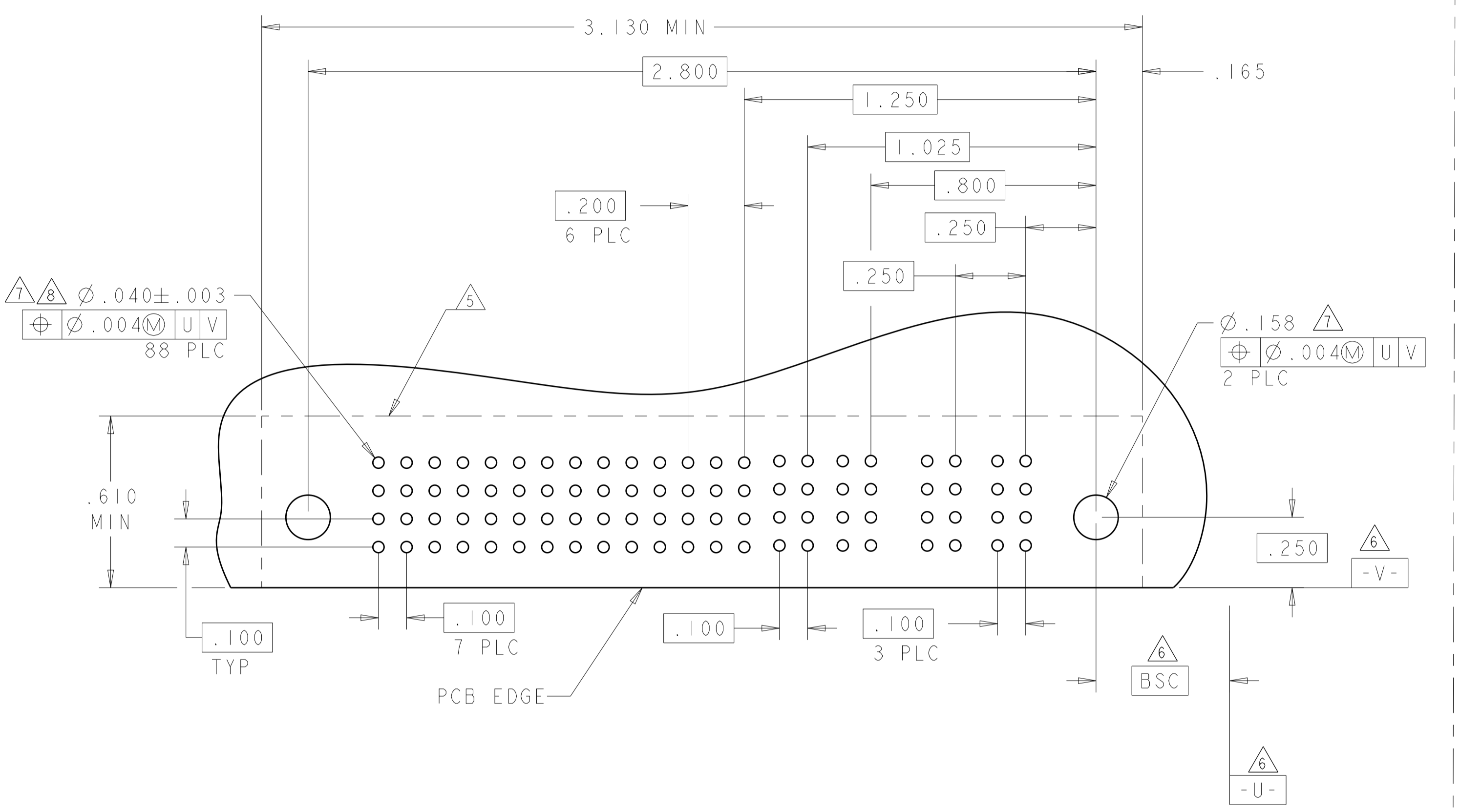

PART NUMBER	ROWS	POWER		SIGNAL				POWER
		P2	P1	4	3	2	1	P1
1-6450360-2	D C B A	RA	RA	H	H	H	H	RA
				G	G	G	G	
				F	F	F	F	
				E	E	E	E	

THIS DRAWING IS A CONTROLLED DOCUMENT.		OWN: R. GRZYBOWSKI	OBAPROS		TE Connectivity
DIMENSIONS: INCHES		CHK: M. PERCHERKE	OBAPROS		NAME: RIGHT ANGLE RECEPTACLE ASSEMBLY WITH GUIDES MULTI-BEAM XL
TOLERANCES UNLESS OTHERWISE SPECIFIED:		APVD: M. PERCHERKE		PRODUCT SPEC: 108-1973	
0 PLC ±.01				APPLICATION SPEC: 114-13038	
1 PLC ±.01				SIZE: A1	
2 PLC ±.01				CAGE CODE: 6450360	
3 PLC ±.005				DRAWING NO: 3	
4 PLC ±.002				SHEET 3 OF 6	
ANGLES ±.020				REV: H5	
FINISH: *				CUSTOMER DRAWING	
MATERIAL: -				SCALE: 4:1	
WEIGHT: -				SHEET 3 OF 6	

REVISIONS				
P.	LTN.	DESCRIPTION	DATE	APVD.
-	-	SEE SHEET 1	-	-

PART NUMBER	ROWS	POWER		SIGNAL												POWER				
		P4	P3	12	11	10	9	8	7	6	5	4	3	2	1	P2	P1			
1-6450360-3	D	RM	RM	H	H	H	H	H	H	H	H	H	H	H	H	H	H	RM	RM	
	C			G	G	G	G	G	G	G	G	G	G	G	G	G	G			
	B			F	F	F	F	F	F	F	F	F	F	F	F	F	F			F
	A			E	E	E	E	E	E	E	E	E	E	E	E	E	E			E

2P + 48S + 2P

PART NUMBER	ROWS	POWER		SIGNAL				POWER	
		P4	P3	4	3	2	1	P2	P1
1-6450360-4	D	RM	RM	H	H	H	H	RM	RM
	C			G	G	G	G		
	B			F	F	F	F		
	A			E	E	E	E		

2P + 16S + 2P

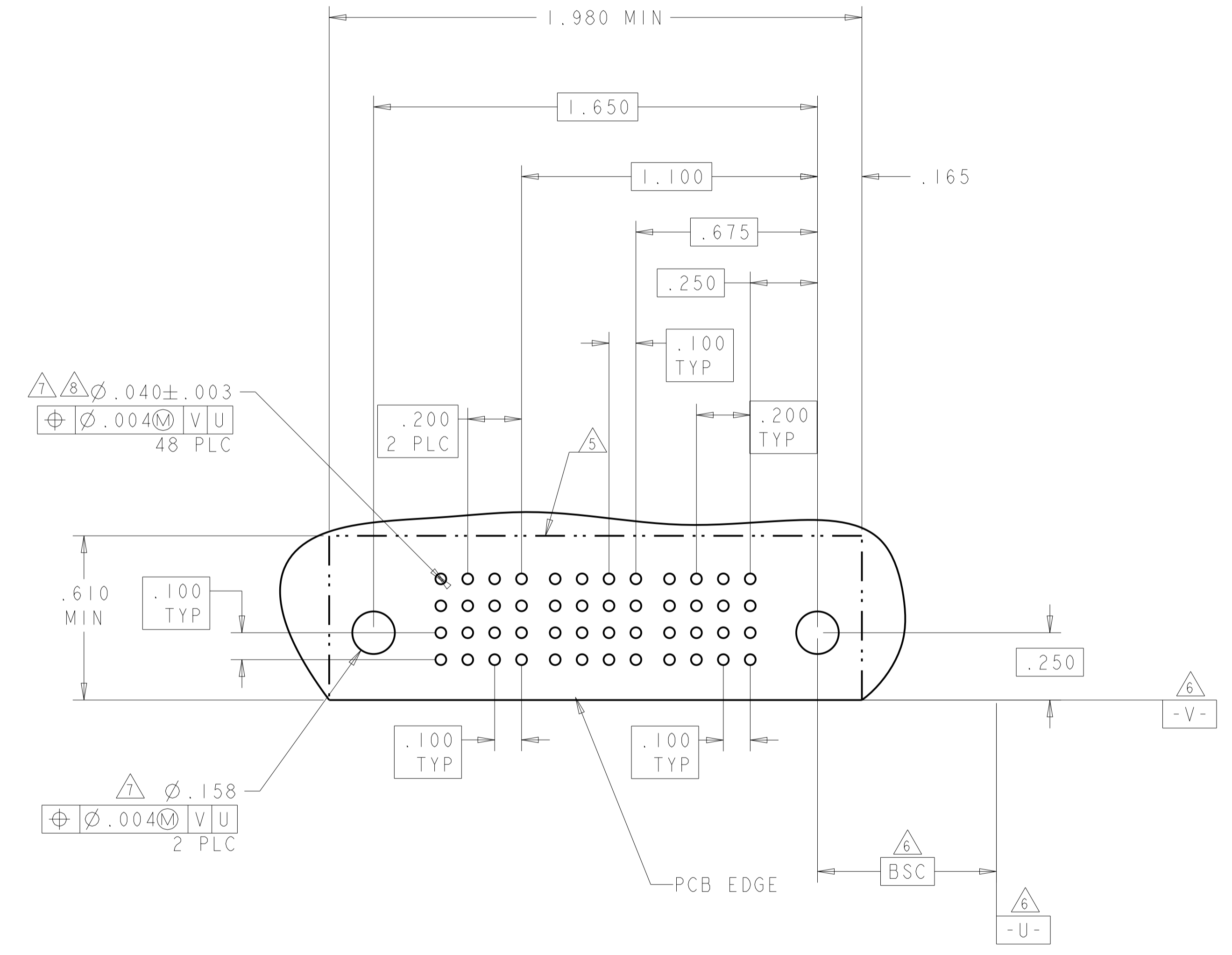
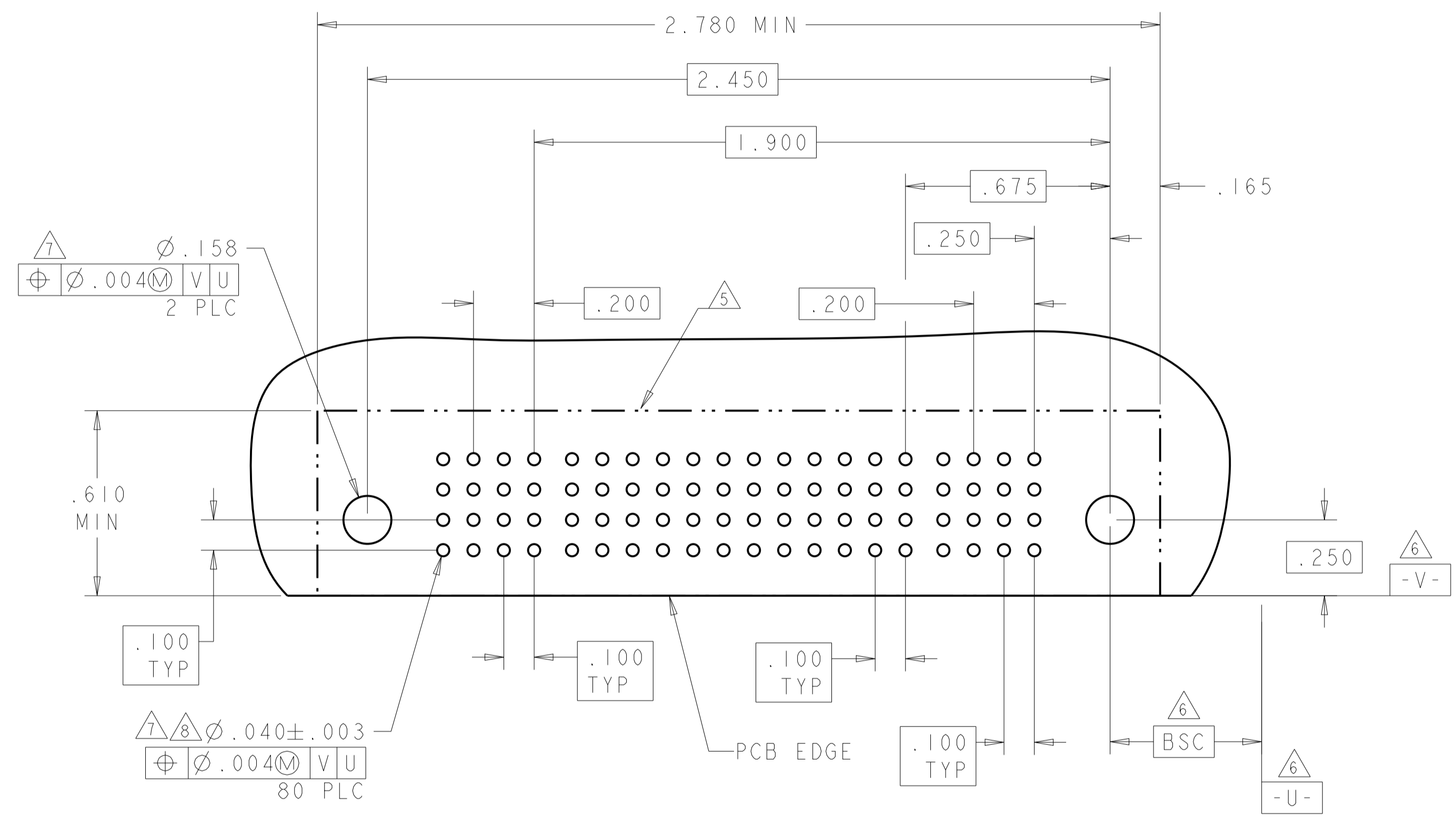

THIS DRAWING IS A CONTROLLED DOCUMENT.

DIMENSIONS: INCHES	TOLERANCES UNLESS OTHERWISE SPECIFIED: 0 PLC ±. 2 PLC ±.01 3 PLC ±.005 4 PLC ±.0020 ANGLES ±.02°	FINISH	OWN: R. GRZYBOWSKI / 08APROS CHK: M. PERCHERKE / 08APROS APVD: M. PERCHERKE / -	NAME: RIGHT ANGLE RECEPTACLE ASSEMBLY WITH GUIDES MULTI-BEAM XL
MATERIAL	FINISH	WEIGHT	SIZE: 114-13038 CAGE CODE: A100779 DRAWING NO: C=6450360	RESTRICTED TO: -
CUSTOMER DRAWING			SCALE: 4:1	SHEET: 4 OF 6

REV: H5

REVISIONS				
P.	LTN.	DESCRIPTION	DATE	APP'D.
-	-	SEE SHEET 1	-	-

PART NUMBER	ROWS	POWER		SIGNAL			POWER	
		P4	P3	3	2	1	P2	P1
6450360-7	D C B A	RA	RA	H	H	H	RA	RA
				G	G	G		
				F	F	F		
				E	E	E		
2P + 12S + 2P								

PART NUMBER	ROWS	POWER		SIGNAL										POWER						
		P6	P5	11	10	9	8	7	6	5	4	3	2	1	P5	P4	P3	P2	P1	
1-6450360-5	D C B A	RM	RM	H	H	H	H	H	H	H	H	H	H	H	RM	RM	RM	RM	RM	
				G	G	G														
				F	F	F	F	F	F	F	F	F	F	F						F
				E	E	E	E	E	E	E	E	E	E	E						E
5P + 44S + 1P																				

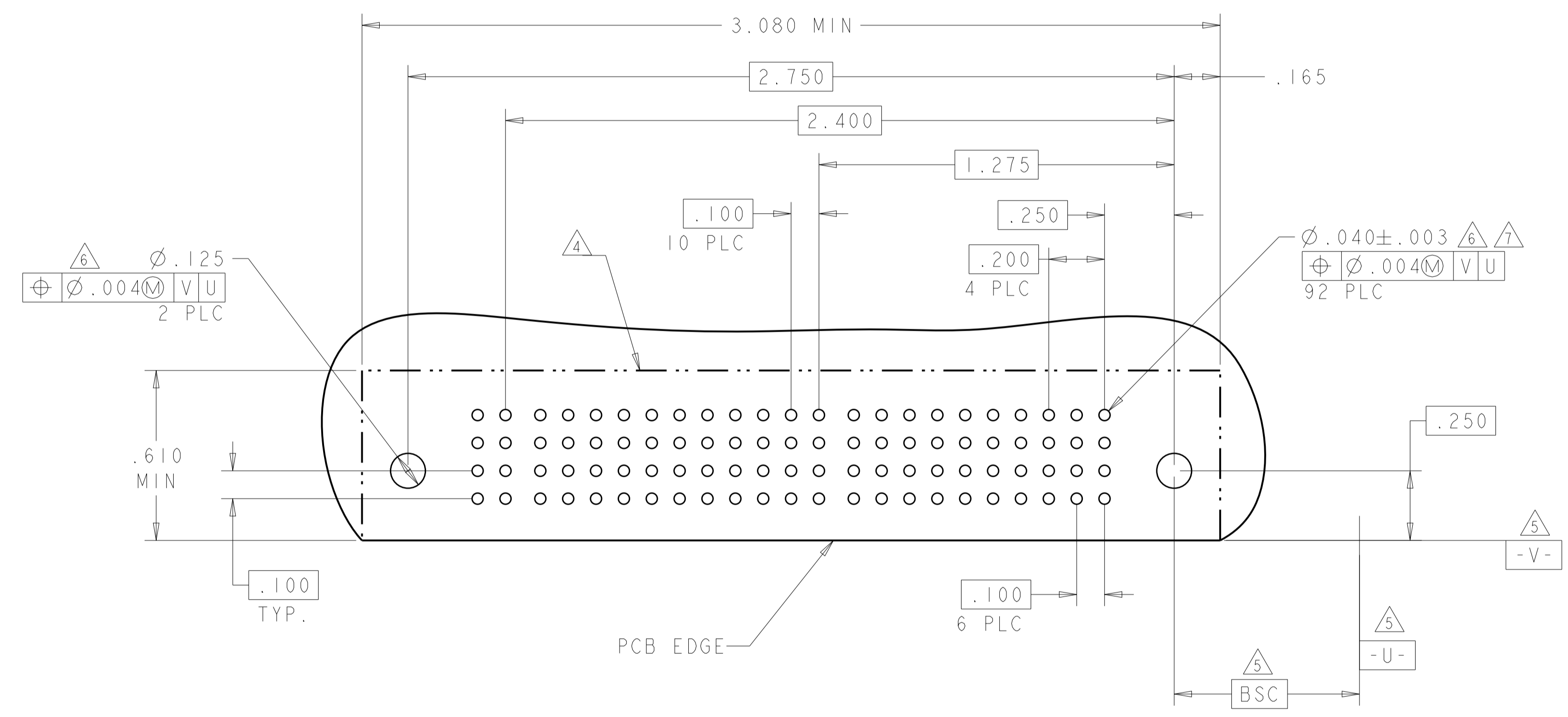
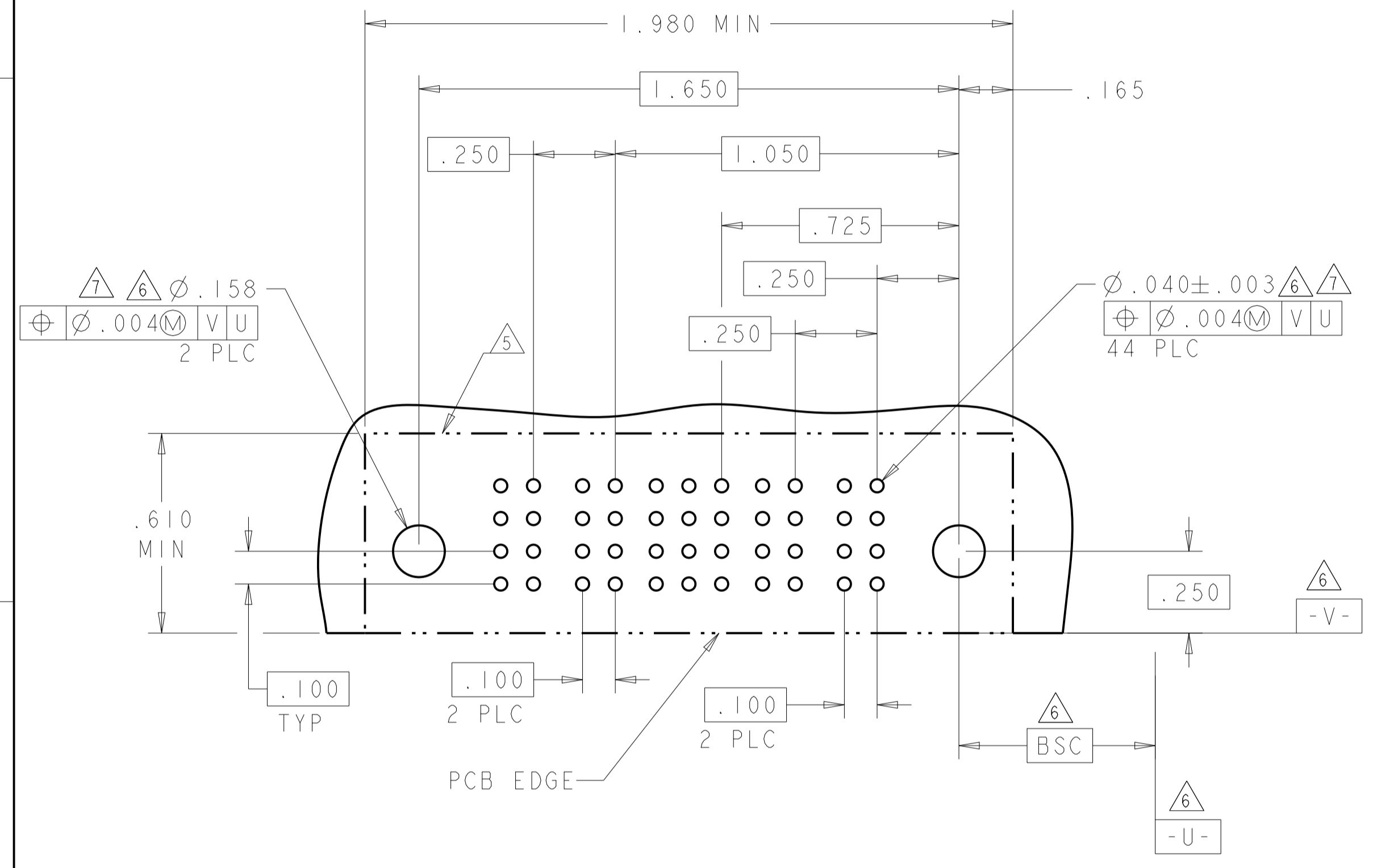

THIS DRAWING IS A CONTROLLED DOCUMENT.

DIMENSIONS: INCHES	TOLERANCES UNLESS OTHERWISE SPECIFIED: 0 PLC ±. 2 PLC ±.01 3 PLC ±.005 4 PLC ±.0020 ANGLES ±.020	FINISH	FINISH
-----------------------	---	--------	--------

OWN: R. GRZYBOWSKI 08APROS	CHK: M. PERCHERKE 08APROS	APVD: M. PERCHERKE	NAME: R. GRZYBOWSKI
PRODUCT SPEC: 108-1973		APPLICATION SPEC: 114-13038	
WEIGHT: -		CAGE CODE: A100779	
CUSTOMER DRAWING		SCALE: 4:1	

**STE** TE Connectivity

RIGHT ANGLE RECEPTACLE ASSEMBLY WITH GUIDES MULTI-BEAM XL

SIZE: A100779 C=6450360

SHEET 5 OF 6 REV H5

REVISIONS				
P.	LTN	DESCRIPTION	DATE	APVD
-	-	SEE SHEET 1	-	-

PART NUMBER	ROWS	SIGNAL													POWER			
		P5	12	11	10	9	8	7	6	5	4	3	2	1	P4	P3	P2	P1
1-6450360-6	D	RM	H		H	H	H		H	H			H	RM	RM	RM	RM	
	C		G		G	G	G		G	G	G	G						
	B		F		F	F	F		F		F	F						
	A		E		E	E	E	E	E	E	E	E						

4P + 48S + 1P

BLANK SIGNAL PINS ARE UNLOADED

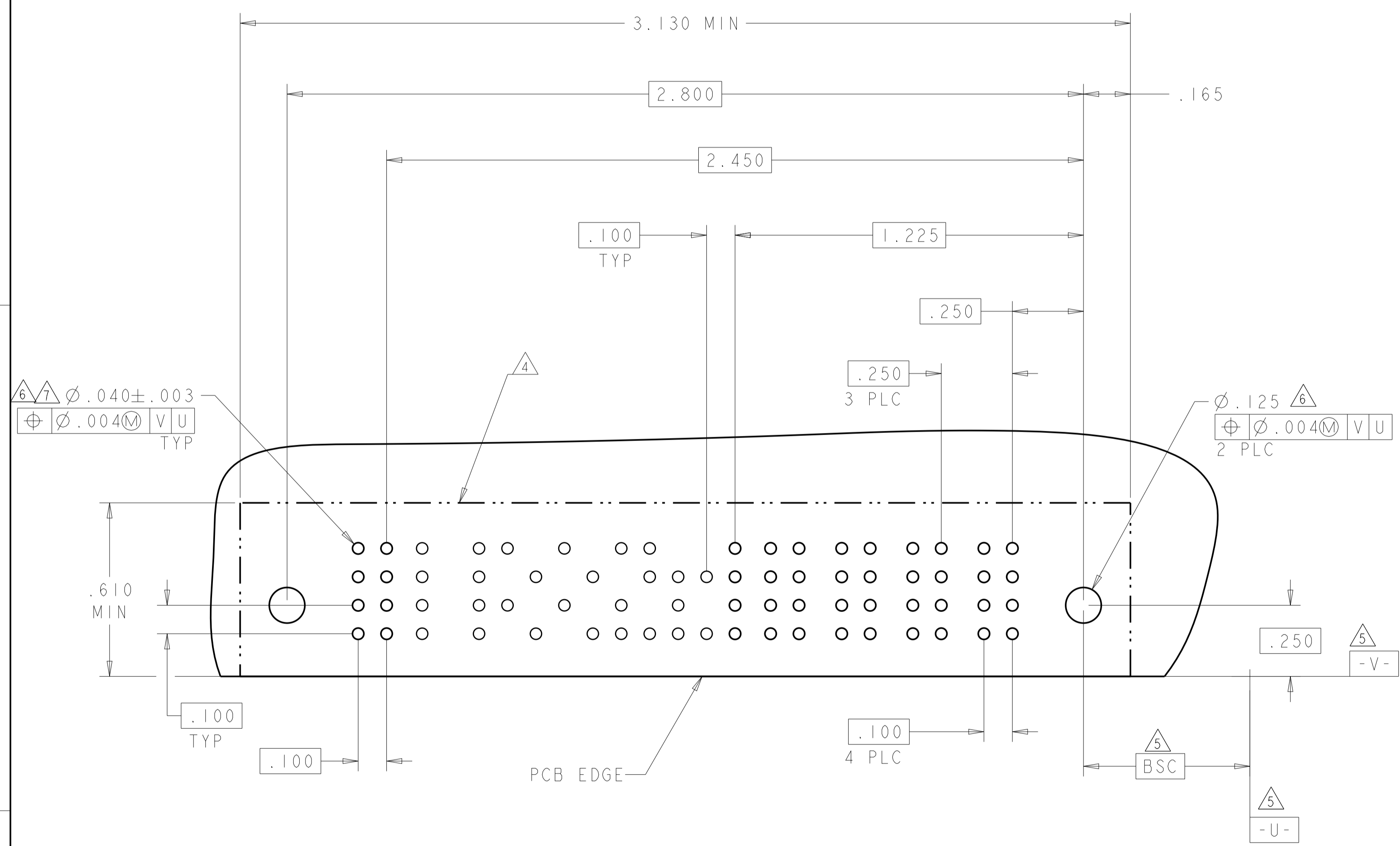

THIS DRAWING IS A CONTROLLED DOCUMENT.		OWN R. GRZYBOWSKI	08APROS		TE Connectivity	
DIMENSIONS: INCHES		CHK M. PERCHERKE	08APROS		NAME RIGHT ANGLE RECEPTACLE ASSEMBLY WITH GUIDES MULTI-BEAM XL	
TOLERANCES UNLESS OTHERWISE SPECIFIED:		APVD M. PERCHERKE		PRODUCT SPEC		
0 PLC ±		108-1973		APPLICATION SPEC		
1 PLC ±.01		114-13038		RESTRICTED TO		
2 PLC ±.05		A100779		C=6450360		
3 PLC ±.0020		SCALE 4:1		SHEET 6 OF 6		
4 PLC ±.0020		REV H5		CUSTOMER DRAWING		
ANGLES ±.2°		SCALE 4:1		SHEET 6 OF 6		
FINISH		SCALE 4:1		SHEET 6 OF 6		
MATERIAL		SCALE 4:1		SHEET 6 OF 6		
FINISH		SCALE 4:1		SHEET 6 OF 6		

Компания «Life Electronics» занимается поставками электронных компонентов импортного и отечественного производства от производителей и со складов крупных дистрибьюторов Европы, Америки и Азии.

С конца 2013 года компания активно расширяет линейку поставок компонентов по направлению коаксиальный кабель, кварцевые генераторы и конденсаторы (керамические, пленочные, электролитические), за счёт заключения дистрибьюторских договоров

Мы предлагаем:

- Конкурентоспособные цены и скидки постоянным клиентам.
- Специальные условия для постоянных клиентов.
- Подбор аналогов.
- Поставку компонентов в любых объемах, удовлетворяющих вашим потребностям.
- Приемлемые сроки поставки, возможна ускоренная поставка.
- Доставку товара в любую точку России и стран СНГ.
- Комплексную поставку.
- Работу по проектам и поставку образцов.
- Формирование склада под заказчика.
- Сертификаты соответствия на поставляемую продукцию (по желанию клиента).
- Тестирование поставляемой продукции.
- Поставку компонентов, требующих военную и космическую приемку.
- Входной контроль качества.
- Наличие сертификата ISO.

В составе нашей компании организован Конструкторский отдел, призванный помогать разработчикам, и инженерам.

Конструкторский отдел помогает осуществить:

- Регистрацию проекта у производителя компонентов.
- Техническую поддержку проекта.
- Защиту от снятия компонента с производства.
- Оценку стоимости проекта по компонентам.
- Изготовление тестовой платы монтаж и пусконаладочные работы.



Тел: +7 (812) 336 43 04 (многоканальный)

Email: [org@lifeelectronics.ru](mailto:org@lifeelectronics.ru)