

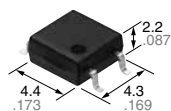

50 Mbps type	PhotoIC Coupler (AlGaAs LED & PhotoIC) (APS1)
---------------------	--

New



mm inch

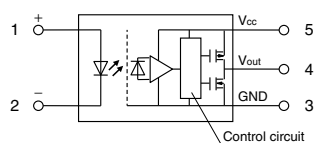

Truth table

LED	Output
ON	L
OFF	H

RoHS compliant

FEATURES

1. High speed Photo Coupler with receiver circuit IC
2. Capable of high speed communication
(Transfer rate Typ. 50 Mbps)
3. High noise immunity
(CMTI Min. 15 kV/ μ s)
4. Guaranteed performance at high temperature
(-40 to +105°C -40 to +221°F)
5. Isolation voltage: 3,750 Vrms
6. Totem pole output type

TYPICAL APPLICATIONS

1. Measuring equipment
2. FA (Factory Automation) network
3. I/O of high speed communication

*Does not support automotive application

TYPES

Figure of output	Transfer rate	Supply voltage	Part No.			Packing quantity	
			Tube packing style	Tape and reel packing style		Tube	Tape and reel
				Picked from the 1/2-pin side	Picked from the 3/4/5-pin side		
Totem pole output	Typ. 50 Mbps	5 V DC	APS1551S	APS1551SX	APS1551SZ	1 tube contains: 100 pcs. 1 batch contains: 2,000 pcs.	1,000 pcs.

PhotoIC Coupler 50 Mbps type (APS1)

RATING

1. Absolute maximum ratings (Ta = 25°C 77°F)

Item		Symbol	APS1551S	Remarks
Input	LED forward current	I _F	25 mA	
	LED reverse voltage	V _R	5 V	
	Peak forward current	I _{FP}	1 A	f = 100 Hz, Duty factor = 0.1%, 1 shot
Output	Supply voltage	V _{CC}	6 V	
	Output voltage	V _O	6 V	
	Output current	I _O	10 mA	
	Power dissipation	P _{out}	40 mW	
I/O isolation voltage		V _{iso}	3,750 V rms	
Ambient temperature	Operating	T _{opr}	-40 to +105°C -40 to +221°F	(Non-icing at low temperatures)
	Storage	T _{stg}	-40 to +125°C -40 to +257°F	

2. Electrical characteristics (Unless otherwise specified, Ta = -40 to 105°C -40 to 221°F, V_{CC} = 4.5 to 5.5V)

Item		Symbol	APS1551S	Condition
Input	Threshold input current	Max. I _{FHL}	5 mA	V _{CC} = 5 V, V _O < 0.6 V
	LED dropout voltage	Min.	1.45 V	I _F = 10 mA, Ta = 25°C 77°F
		Typ. V _F	1.6 V	
		Max.	1.8 V	
Input capacitance	Typ. C _I	20 pF	f = 1 MHz, V _B = 0 V, Ta = 25°C 77°F	
Output	Low level supply current	Max. I _{CCL}	5 mA	I _F = 10 mA
	High level supply current	Max. I _{CCH}	5 mA	I _F = 0 mA
	Low level output voltage	Max. V _{OL}	0.6 V	I _F = 10 mA, I _O = 4 mA, V _{CC} = 5V
	High level output voltage	Min. V _{OH}	4.4 V	I _F = 0 mA, I _O = -4 mA, V _{CC} = 5 V

Item		Symbol	APS1551S	Condition
Transfer characteristics	Propagation delay time (H → L)	Max. t _{pHL}	30 ns	V _{IN} = 0 → 5 V, R _{IN} = 300 Ω C _{IN} = 22 pF, C _O = 15 pF
	Propagation delay time (L → H)	Max. t _{pLH}	30 ns	V _{IN} = 5 → 0 V, R _{IN} = 300 Ω C _{IN} = 22 pF, C _O = 15 pF
	Propagation delay skew	Max. t _{psk}	16 ns	—
	Pulse width distortion	Max. t _{pHL} - t _{pLH}	10 ns	V _{IN} = 5 V/25 MHz, R _{IN} = 300 Ω C _{IN} = 22 pF, C _O = 15 pF
	Output fall time	Typ. t _f	5 ns	V _{IN} = 0 → 5 V, R _{IN} = 300 Ω C _{IN} = 22 pF, C _O = 15 pF
	Output rise time	Typ. t _r	4 ns	V _{IN} = 5 → 0 V, R _{IN} = 300 Ω C _{IN} = 22 pF, C _O = 15 pF
	Common mode transient immunity at low level output	Min. C _{ML}	15 kV/μs	V _{CM} = 1000 V _{p-p} , I _F = 10 mA, V _{CC} = 5 V V _{O(MAX)} = 0.4 V, Ta = 25°C 77°F
	Common mode transient immunity at high level output	Min. C _{MH}	15 kV/μs	V _{CM} = 1000 V _{p-p} , I _F = 0 mA, V _{CC} = 5 V V _{O(MIN)} = 4 V, Ta = 25°C 77°F
	I/O capacitance	Typ. C _{iso}	0.5 pF	f = 1 MHz, V _B = 0 V, Ta = 25°C 77°F
	Initial I/O isolation resistance	Min. R _{iso}	1,000 MΩ	DC 500V, RH ≤ 60 %, Ta = 25°C 77°F

Test circuit for I_{CCL}

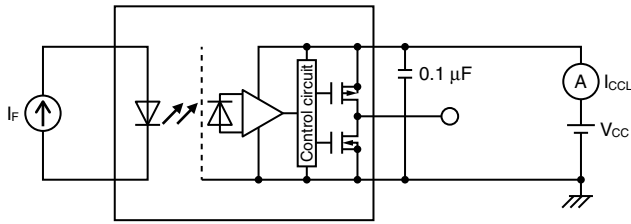

Test circuit for I_{CCH}

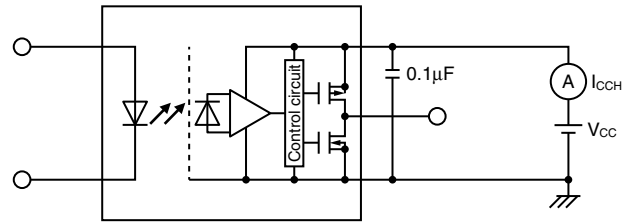

Test circuit for V_{OL}

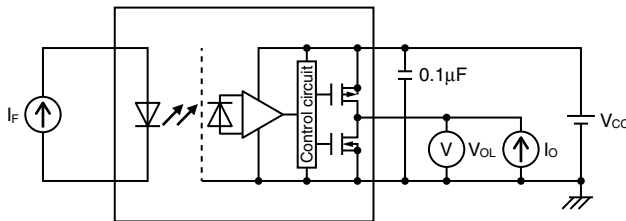

Test circuit for V_{OH}

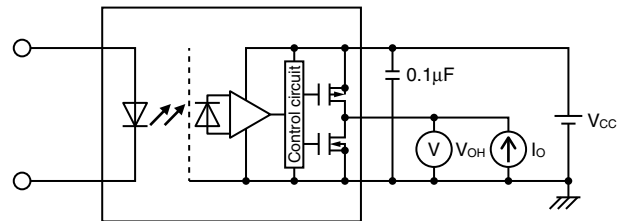

Test circuit for propagation delay time

$V_{IN} = 0 \leftrightarrow 5 \text{ V}$

$f = 25 \text{ MHz}$

Duty factor = 50%

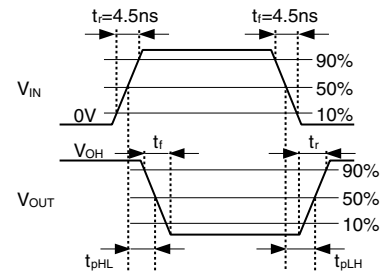
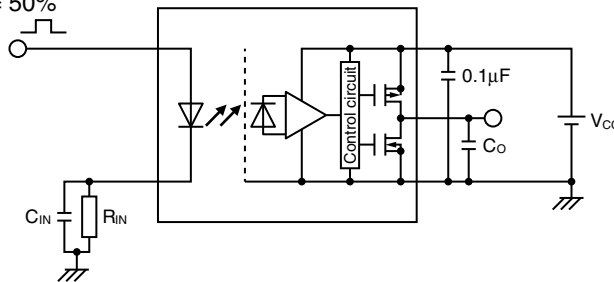

Test circuit for common mode transient immunity

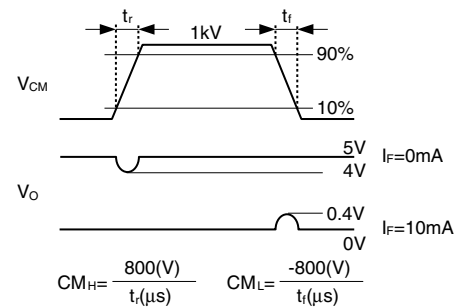
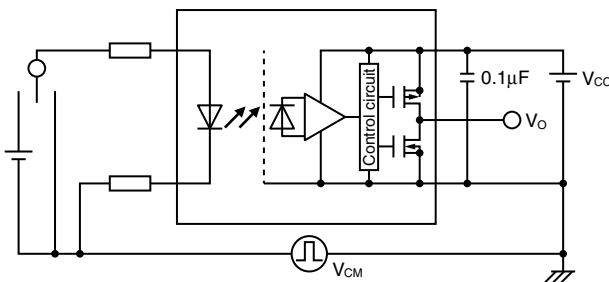

RECOMMENDED OPERATING CONDITIONS

Item	Symbol	Min.	Typ.	Max.	Unit
LED forward current	I_F	10	—	16	mA
Supply voltage	V_{CC}	4.5	5	5.5	V
LED off voltage	$V_{F(OFF)}$	0	—	0.8	V

Please use under recommended operating conditions to obtain expected characteristics.

Additionally, please check other conditions in this specification sheets because they are affected by the actual usage.

PhotoIC Coupler 50 Mbps type (APS1)

REFERENCE DATA

1. LED forward current vs. ambient temperature characteristics

Permissible ambient temperature: -40 to $+105$ °C
 -40 to $+221$ °F

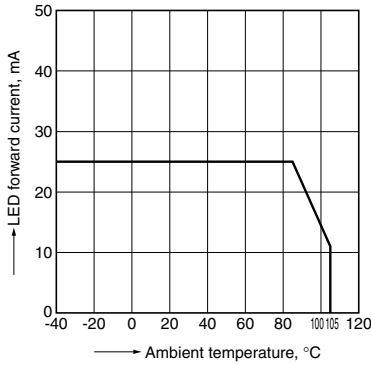

2. LED forward current vs. LED drop out voltage characteristics

Permissible ambient temperature: -40 to $+105$ °C
 -40 to $+221$ °F

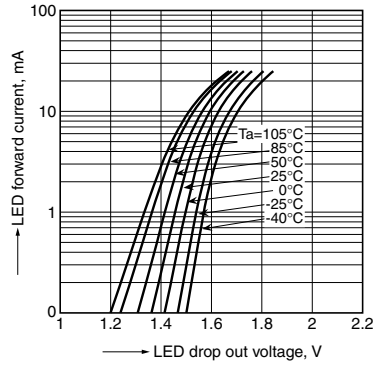

3. Threshold input current vs. ambient temperature characteristics

Supply voltage: 5 V
 Output voltage: < 0.6 V

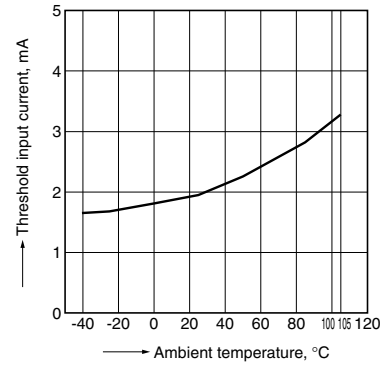

4. Low level/high level supply current vs. ambient temperature characteristics

Supply voltage: 5 V

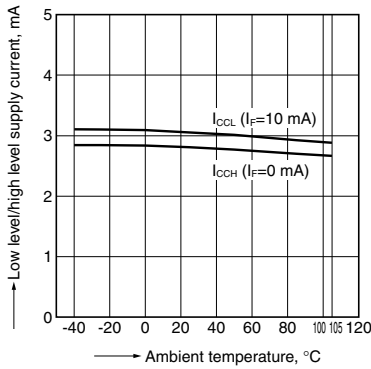

5. Low level output voltage vs. ambient temperature characteristics

Supply voltage: 5 V
 LED current: 10 mA
 Output current: 4 mA

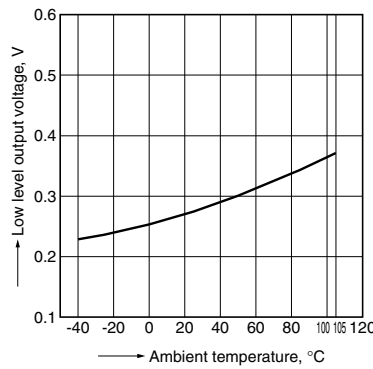

6. High level output voltage vs. ambient temperature characteristics

Supply voltage: 5 V
 LED current: 0 mA
 Output current: 4 mA

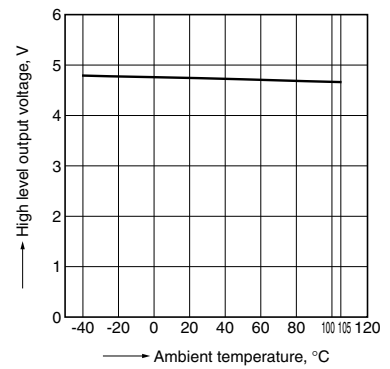

7. Propagation delay time (H → L/L → H) vs. ambient temperature characteristics

Supply voltage: 5 V
 LED current: 10 mA

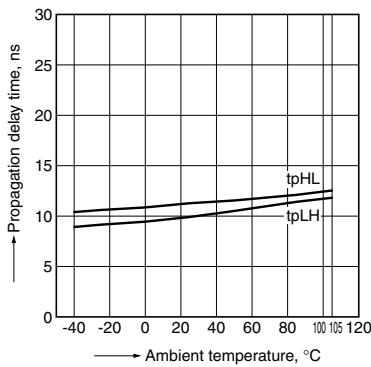

8. Pulse width distortion vs. ambient temperature characteristics

Supply voltage: 5 V
 LED current: 10 mA

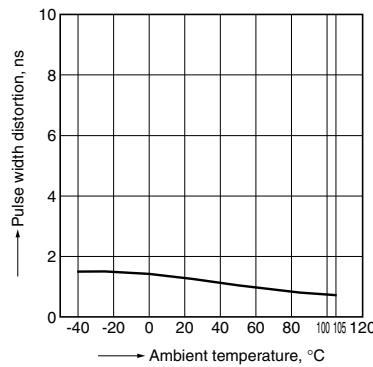

9. Propagation delay time (H → L/L → H) vs. LED forward current characteristics

Supply voltage: 5 V
 Ambient temperature: 25 °C 77 °F

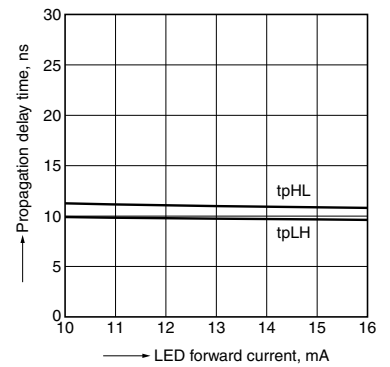

10. Pulse width distortion vs. LED forward current characteristics

Supply voltage: 5 V

Ambient temperature: 25 °C 77 °F

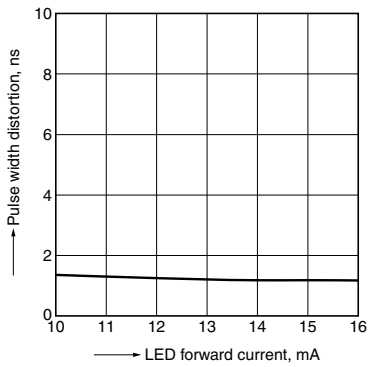

DIMENSIONS (mm inch)

The CAD data of the products with a **CAD** mark can be downloaded from: <http://industrial.panasonic.com/ac/e/>

CAD

External dimensions

Recommended mounting pad (Top view)

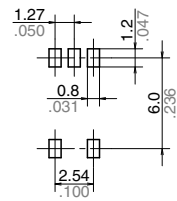
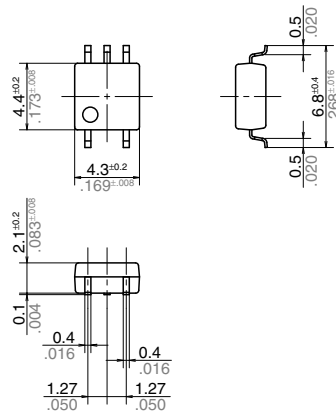

Tolerance: $\pm 0.1 \pm 0.004$

Terminal thickness = $\pm 0.15 \pm 0.006$

General tolerance: $\pm 0.1 \pm 0.004$

CAUTIONS FOR USE

SAFETY WARNINGS

- Do not use the product under conditions that exceed the range of its specifications. It may cause overheating, smoke, or fire.
- Do not touch the recharging unit while the power is on. There is a danger of electrical shock. Be sure to turn off the power when performing mounting, maintenance, or repair operations on the device (including connecting parts such as the terminal board and socket).
- Check the connection diagrams in the catalog and be sure to connect the terminals correctly. Erroneous connections could lead to unexpected operating errors, overheating, or fire.

1. Please visit our Automation Controls Products web site and refer to the caution for use and the explanations of technical terms.

2. About derating design

Derating is significant factor concerning on reliable design (product life). When the coupler is used continuously at upper limit of absolute maximum ratings (high temperature, high humidity, high current, high voltage, etc.), reliability may be lower significantly. Therefore, please derate sufficiently below the absolute maximum ratings and evaluate the coupler under the actual condition.

3. Wire connection

Please check the internal connection diagram in the catalog or specification, and connect the terminals correctly. If device is energized with short-circuit or any wrong connection, it may cause circuit damage by inner parts destruction, unexpected malfunction, abnormal heat, fire, and so on.

4. Bypass capacitor

Bypass capacitor of 0.1 μ F is used between Vcc and GND near the coupler. Also, ensure that the distance between the leads of the coupler and capacitor is no more than 10 mm. Failure to provide the bypass may impair the switching property.

5. Deterioration and destruction caused by discharge of static electricity

This phenomenon is generally called static electricity destruction, and occurs when static electricity generated by various factors is discharged while the coupler terminals are in contact, producing internal destruction of the element. To prevent problems from static electricity, the following precautions and measures should be taken when using your device.

- (1) Employees handling the coupler should wear anti-static clothing and should be grounded through protective resistance of 500 k Ω to 1 M Ω .
- (2) A conductive metal sheet should be placed over the worktable. Measuring instruments and jigs should be grounded.
- (3) When using soldering irons, either use irons with low leakage current, or ground the tip of the soldering iron. (Use of low-voltage soldering irons is also recommended.)
- (4) Devices and equipment used in assembly should also be grounded.
- (5) When packing printed circuit boards and equipment, avoid using high-polymer materials such as foam styrene, plastic, and other materials which carry an electrostatic charge.
- (6) When storing or transporting the coupler, the environment should not be conducive to generating static electricity (for instance, the humidity should be between 45 and 60 %), and the coupler should be protected using conductive packing materials.

6. Ripple in the input power supply

If ripple is present in the input power supply, please keep the LED forward current from 10 (at Emin) to 16 mA(at Emax).

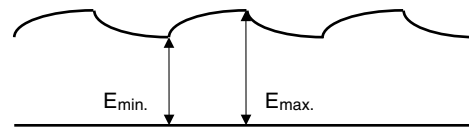

7. Caution for applying supply voltage

Just after supplying voltage, please note that current in the coupler will be not constant until circuit stability.

8. Soldering

(1) IR (Infrared reflow) soldering method

In case of automatic soldering, following conditions should be observed.

(recommended condition

reflow: Max. 2 times, measurement point: soldering lead)

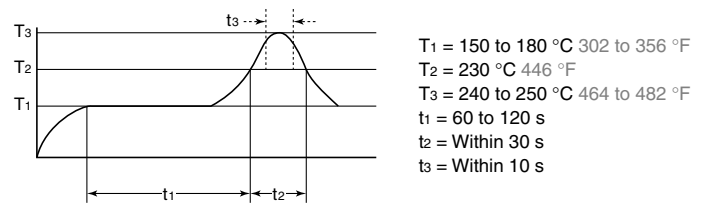

(2) Others soldering methods

Other soldering methods (VPS, hot-air, hot plate, laser heating, pulse heater, etc.) affect the coupler characteristics differently, please evaluate the coupler under the actual usage.

(3) Manual soldering method

Soldering: Max. 350 °C 662 °F, within 3 s, electrical power 30 to 60 W

9. Notes for mounting

- (1) When different kinds of packages are mounted on PCB, the temperature rise at soldering lead is highly dependent on package size. Therefore, please set the lower temperature soldering condition than above condition, and confirm the temperature condition of actual usage before soldering.
- (2) When soldering condition is out of recommendation, the coupler characteristics may be adversely affected. It may occur package crack or bonding wire breaking because of thermal expansion unconformity and resin strength reduction. Please contact us about the propriety of the condition.
- (3) Please confirm the heat stress by using actual board because it may be changed by board condition or manufacturing process condition.
- (4) Solder creepage, wettability, or soldering strength will be affected by the soldering condition or used solder type. Please check them under the actual production condition in detail.
- (5) Please apply coating when the coupler returns to the room temperature.

10. Cleaning solvents compatibility

Cleaning the solder flux should use the immersion washing with an cleaning solvent (Asahiklin AK-225). If you have to use ultrasonic cleaning, please adopt the following conditions and check that there are no problems in the actual usage.

- Frequency: 27 to 29 kHz
- Ultrasonic output: No greater than 0.25 W/cm²*
- Cleaning time: 30 s or less
- Others: Float PCB and the device in cleaning solvent to prevent from contacting the ultrasonic vibrator.

*Note: Applies to unit area of ultrasonic output for ultrasonic baths.

11. Transportation and storage

(1) Extreme vibration during transport may deform the lead or damage the coupler. Please handle the outer and inner boxes with care.

(2) Inadequate storage condition may degrade soldering, appearance and characteristics.

The following storage conditions are recommended:

- Temperature: 0 to 45 °C 32 to 113 °F
- Humidity: Max. 70 %RH
- Atmosphere: No harmful gasses such as sulfurous acid gas and not dusty.

(3) In case the heat stress of soldering is applied to the coupler which absorb moisture inside of its package, the evaporation of the moisture increases the pressure inside the package and it may cause the package blister or crack. This coupler is sensitive to moisture and it is packed in the sealed moisture-proof package. Please make sure the following condition after unsealing.

*Please use the coupler immediately after unsealing. (within 30 days at 0 to 30 °C 32 to 86 °F and Max. 70%RH)

*If the coupler will be kept for a long time after unsealing, please pack in the another moisture-proof package containing silica gel and store. (Please use within 90days)

12. Water condensation

Water condensation occurs when the ambient temperature changes suddenly from a high temperature to low temperature at high humidity, or the coupler is suddenly transferred from a low ambient temperature to a high temperature and humidity. Condensation causes the failures such as insulation deterioration. Panasonic Corporation does not guarantee the failures caused by water condensation.

The heat conduction by the equipment the coupler is mounted may accelerate inside equipment water condensation. Please confirm no that there are condensation in the worst condition of the actual usage.

(Special attention should be paid when high temperature heating parts are close to the coupler.)

13. Coupler packaging format

1) Tape and reel (Unit: mm inch)

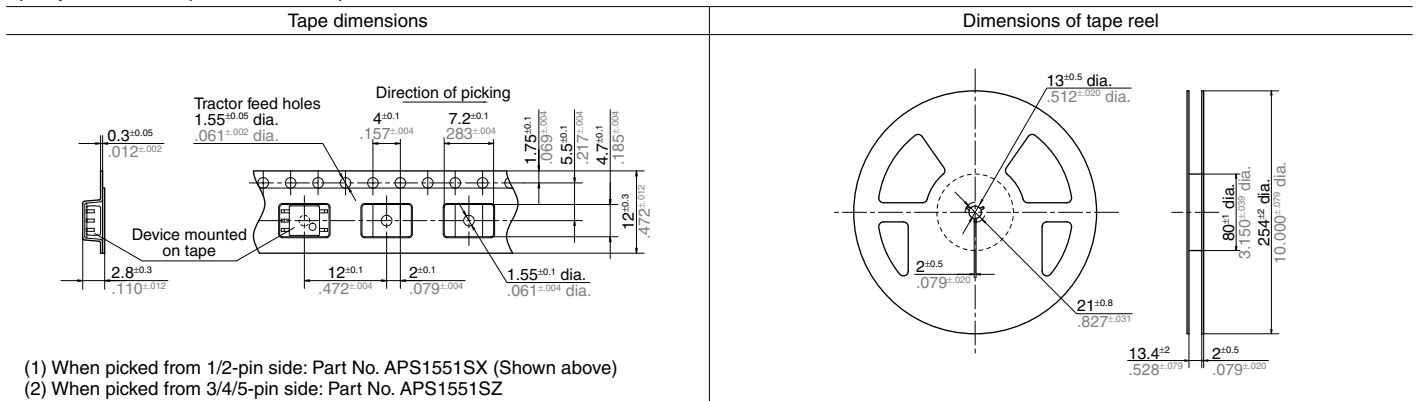

"PhotoMOS®", "PhotoMOS" and "PHOTOMOS" are registered trademarks of Panasonic Corporation.

*Recognized in Japan, the United States, all member states of European Union and other countries.

Please contact

Panasonic Corporation

Electromechanical Control Business Division

■ 1006, Oaza Kadoma, Kadoma-shi, Osaka 571-8506, Japan
industrial.panasonic.com/ac/e/

Panasonic®

©Panasonic Corporation 2017

Mouser Electronics

Authorized Distributor

Click to View Pricing, Inventory, Delivery & Lifecycle Information:

Panasonic:

[APS1551SX](#) [APS1551SZ](#) [APS1551S](#)

Компания «Life Electronics» занимается поставками электронных компонентов импортного и отечественного производства от производителей и со складов крупных дистрибьюторов Европы, Америки и Азии.

С конца 2013 года компания активно расширяет линейку поставок компонентов по направлению коаксиальный кабель, кварцевые генераторы и конденсаторы (керамические, пленочные, электролитические), за счёт заключения дистрибьюторских договоров

Мы предлагаем:

- Конкуренспособные цены и скидки постоянным клиентам.
- Специальные условия для постоянных клиентов.
- Подбор аналогов.
- Поставку компонентов в любых объемах, удовлетворяющих вашим потребностям.
- Приемлемые сроки поставки, возможна ускоренная поставка.
- Доставку товара в любую точку России и стран СНГ.
- Комплексную поставку.
- Работу по проектам и поставку образцов.
- Формирование склада под заказчика.
- Сертификаты соответствия на поставляемую продукцию (по желанию клиента).
- Тестирование поставляемой продукции.
- Поставку компонентов, требующих военную и космическую приемку.
- Входной контроль качества.
- Наличие сертификата ISO.

В составе нашей компании организован Конструкторский отдел, призванный помогать разработчикам, и инженерам.

Конструкторский отдел помогает осуществить:

- Регистрацию проекта у производителя компонентов.
- Техническую поддержку проекта.
- Защиту от снятия компонента с производства.
- Оценку стоимости проекта по компонентам.
- Изготовление тестовой платы монтаж и пусконаладочные работы.



Тел: +7 (812) 336 43 04 (многоканальный)
Email: org@lifeelectronics.ru