

NCP347

Positive Overvoltage Protection Controller with Internal Low R_{ON} NMOS FET and Status \overline{FLAG}

The NCP347 is able to disconnect the systems from its output pin in case wrong input operating conditions are detected. The system is positive overvoltage protected up to +28 V.

Due to this device using internal NMOS, no external device is necessary, reducing the system cost and the PCB area of the application board.

The NCP347 is able to instantaneously disconnect the output from the input, due to integrated Low R_{ON} Power NMOS (65 m Ω), if the input voltage exceeds the overvoltage threshold (OVLO) or undervoltage threshold (UVLO).

At powerup (\overline{EN} pin = low level), the V_{out} turns on 50 ms after the V_{in} exceeds the undervoltage threshold.

The NCP347 provides a negative going flag (\overline{FLAG}) output, which alerts the system that a fault has occurred.

In addition, the device has ESD-protected input (15 kV Air) when bypassed with a 1.0 μ F or larger capacitor.

Features

- Overvoltage Protection up to 28 V
- On-Chip Low $R_{DS(on)}$ NMOS Transistor: 65 m Ω
- Internal Charge Pump
- Overvoltage Lockout (OVLO)
- Undervoltage Lockout (UVLO)
- Internal 50 ms Startup Delay
- Alert \overline{FLAG} Output
- Shutdown \overline{EN} Input
- Compliance to IEC61000-4-2 (Level 4)
 - 8.0 kV (Contact)
 - 15 kV (Air)
- ESD Ratings: Machine Model = B
Human Body Model = 3
- 10 Lead WDFN 2.5x2 mm Package
- This is a Pb-Free Device

Applications

- Cell Phones
- Camera Phones
- Digital Still Cameras
- Personal Digital Applications
- MP3 Players



ON Semiconductor®

<http://onsemi.com>



WDFN10
MT SUFFIX
CASE 516AA

MARKING DIAGRAM

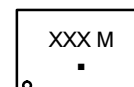

XXX = Specific Device Code
M = Date Code
■ = Pb-Free Package

PIN CONNECTIONS

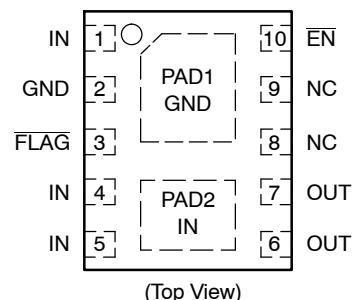

ORDERING INFORMATION

See detailed ordering, marking and shipping information in the package dimensions section on page 12 of this data sheet.

NCP347



Figure 1. Typical Application Circuit

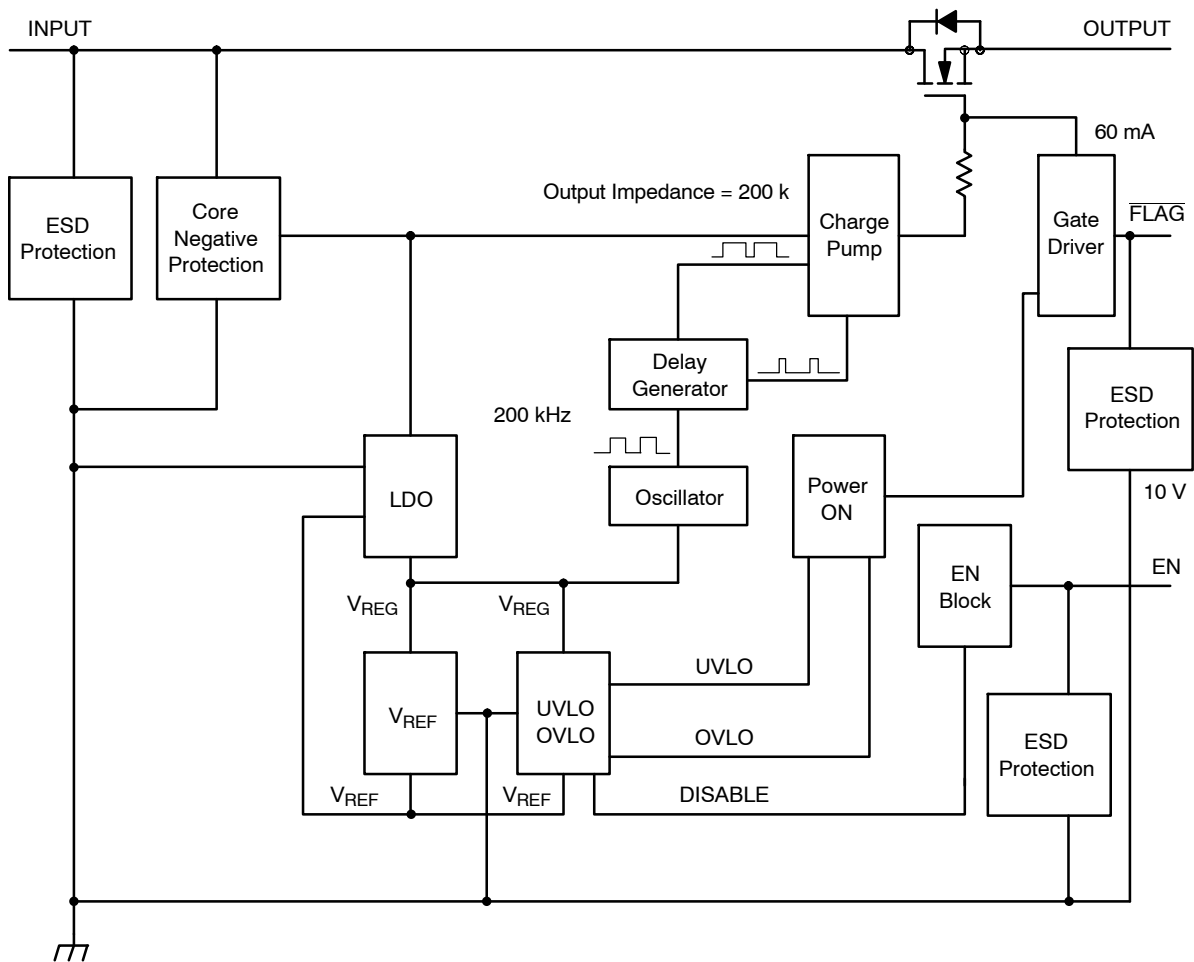

Figure 2. Functional Block Diagram

NCP347

PIN FUNCTION DESCRIPTION

Pin No.	Symbol	Function	Description
1 4 5	IN	POWER	Input Voltage Pin. This pin is connected to the power supply. The device system core is supplied by this input. A 1 μ F low ESR ceramic capacitor, or larger, must be connected between this pin and GND. The three IN pins must be hardwired to common supply.
2	GND	POWER	Ground
3	$\overline{\text{FLAG}}$	OUTPUT	Fault Indication Pin. This pin allows an external system to detect a fault on IN pin. The $\overline{\text{FLAG}}$ pin goes low when input voltage exceeds OVLO threshold or drop below UVLO threshold. Since the $\overline{\text{FLAG}}$ pin is open drain functionality, an external pull up resistor to V_{CC} must be added.
6 7	OUT	OUTPUT	Output Voltage Pin. This pin follows IN pin when “no fault” is detected. The output is disconnected from the V_{in} power supply when the input voltage is under the UVLO threshold or above OVLO threshold. The two OUT pins must be hardwired to common supply.
8	NC	OPEN	No Connect
9	NC	OPEN	No Connect
10	$\overline{\text{EN}}$	INPUT	Enable Pin. The device enters in shutdown mode when this pin is tied to a high level. In this case the output is disconnected from the input. To allow normal functionality, the $\overline{\text{EN}}$ pin shall be connected to GND to a pull down or to a I/O pin. This pin does not have an impact on the fault detection.
PAD1			PAD1, under the device. See PCB recommendations page 10. Can be shorted to GND.
PAD2			The PAD2 is electrically connected to the internal NMOS drain and connected to Pins 4 and 5. See PCB recommendations page 10.

MAXIMUM RATINGS

Rating	Symbol	Value	Unit
Minimum Voltage (IN to GND)	$V_{min_{in}}$	-0.3	V
Minimum Voltage (All others to GND)	V_{min}	-0.3	V
Maximum Voltage (IN to GND)	$V_{max_{in}}$	30	V
Maximum Voltage (All others to GND)	V_{max}	7.0	V
Maximum Current (UVLO < V_{IN} < OVLO)	I_{max}	2.0	A
Thermal Resistance, Junction-to-Air (Note 1)	$R_{\theta JA}$	280	$^{\circ}\text{C}/\text{W}$
Operating Ambient Temperature Range	T_A	-40 to +85	$^{\circ}\text{C}$
Storage Temperature Range	T_{stg}	-65 to +150	$^{\circ}\text{C}$
Junction Operating Temperature	T_J	150	$^{\circ}\text{C}$
ESD Withstand Voltage (IEC 61000-4-2) (input only) when bypassed with 1.0 μ F capacitor Human Body Model (HBM), Model = 2 (Note 2) Machine Model (MM) Model = B (Note 3)	V_{esd}	15 Air, 8.0 Contact 2000 200	kV V V
Moisture Sensitivity	MSL	Level 1	-

Stresses exceeding Maximum Ratings may damage the device. Maximum Ratings are stress ratings only. Functional operation above the Recommended Operating Conditions is not implied. Extended exposure to stresses above the Recommended Operating Conditions may affect device reliability.

- The $R_{\theta JA}$ is highly dependent on the PCB heat sink area (connected to pad 2). As example $R_{\theta JA}$ is 268 $^{\circ}\text{C}/\text{W}$ with 30 mm² (copper 35 μ m) and 189 $^{\circ}\text{C}/\text{W}$ with 400 mm².
- Human Body Model, 100 pF discharged through a 1.5 k Ω resistor following specification JESD22/A114.
- Machine Model, 200 pF discharged through all pins following specification JESD22/A115.

NCP347

ELECTRICAL CHARACTERISTICS (Min/Max limits values ($-40^{\circ}\text{C} < T_A < +85^{\circ}\text{C}$) and $V_{in} = +5.0\text{ V}$. Typical values are $T_A = +25^{\circ}\text{C}$, unless otherwise noted.)

Characteristic	Symbol	Conditions	Min	Typ	Max	Unit
Input Voltage Range	V_{in}	-	1.2	-	28	V
Undervoltage Lockout Threshold (Note 4)	UVLO	V_{in} falls down UVLO threshold from 5 V to 2.7 V	2.8	2.95	3.1	V
Undervoltage Lockout Hysteresis	UVLO _{hyst}	V_{in} rises up UVLO + UVLO _{hyst}	30	60	90	mV
Overvoltage Lockout Threshold (Note 4) NCP347MTAE NCP347MTAF NCP347MTAH NCP347MTAI	OVLO	V_{in} rises up OVLO threshold	5.39 5.63 6.80 5.70	5.63 5.90 7.20 5.85	5.88 6.17 7.50 6.00	V
Overvoltage Lockout Hysteresis NCP347MTAE, NCP347MTAF, NCP347MTAI NCP347MTAH	OVLO _{hyst}	V_{in} falls down OVLO + OVLO _{hyst}	30 50	60 70	90 100	mV
V_{in} versus V_{out} Resistance	$R_{DS(on)}$	$V_{in} = 5.0\text{ V}$, $\overline{EN} = \text{GND}$, Load connected to V_{out}	-	65	110	m Ω
Supply Quiescent Current	I _{dd}	No load. $\overline{EN} = 5.0\text{ V}$	-	90	150	μA
		No load. $\overline{EN} = \text{Gnd}$	-	170	250	μA
UVLO Supply Current	I _{dd,uvlo}	$V_{IN} = 2.7\text{ V}$	-	60	-	μA
\overline{FLAG} Output Low Voltage	V _{ol,flag}	1.2 V < V_{IN} < UVLO Sink 50 μA on \overline{FLAG} pin	-	20	400	mV
		$V_{IN} > \text{OVLO}$ Sink 1.0 mA on \overline{FLAG} pin	-	-	400	mV
\overline{FLAG} Leakage Current	\overline{FLAG}_{leak}	\overline{FLAG} level = 5.0 V	-	1.0	-	nA
\overline{EN} Voltage High	V _{ih}	-	1.2	-	-	V
\overline{EN} Voltage Low	V _{ol}	-	-	-	0.4	V
\overline{EN} Leakage Current	\overline{EN}_{leak}	$\overline{EN} = 5.0\text{ V}$ or GND	-	1.0	-	nA

TIMINGS

Startup Delay NCP347MTAE, NCP347MTAF, NCP347MTAH NCP347MTAI	ton	From V_{in} : (0 to (OVLO - 300 mV) < V_{in} < OVLO) to $V_{out} = 0.3\text{ V}$ Rise time < 4 μs (See Figures 3&7)	30 6.0	50 10	70 14	ms
\overline{FLAG} Going Up Delay NCP347MTAE, NCP347MTAF, NCP347MTAH NCP347MTAI	tstart	From $V_{out} = 0.3\text{ V}$ to $\overline{FLAG} = 1.2\text{ V}$ (See Figures 3 & 9)	30 6.0	50 10	70 14	ms
Output Turn Off Time	toff	From $V_{in} > \text{OVLO}$ to $V_{out} < = 0.3\text{ V}$ (See Figures 4 & 8) V_{in} increasing from 5.0 V to 8.0 V at 3.0 V/ μs Rload connected on V_{out}	-	1.5	5.0	μs
Alert Delay	tstop	From $V_{in} > \text{OVLO}$ to $\overline{FLAG} < = 0.4\text{ V}$ (See Figures 4 & 10) V_{in} increasing from 5.0 V to 8.0 V at 3.0 V/ μs Rload connected on V_{out}	-	1.0	-	μs
Disable Time	tdis	From $\overline{EN} > = 1.2\text{ V}$ to $V_{out} < 0.3\text{ V}$ Rload = 5.0 Ω (See Figures 5 & 12)	-	1.0	5.0	μs

NOTE: Electrical parameters are guaranteed by correlation across the full range of temperature.

4. Additional UVLO and OVLO thresholds ranging from UVLO and from OVLO can be manufactured. Contact your ON Semiconductor representative for availability.

NCP347

TIMING DIAGRAMS



Figure 3. Startup



Figure 4. Shutdown on Overvoltage Detection

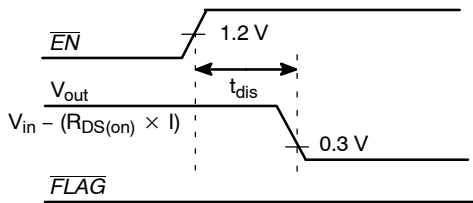

Figure 5. Disable on $\overline{EN} = 1$

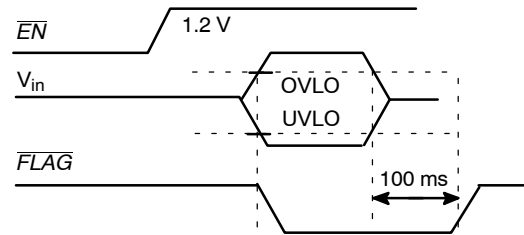

Figure 6. \overline{FLAG} Response with $\overline{EN} = 1$

TYPICAL OPERATING CHARACTERISTICS

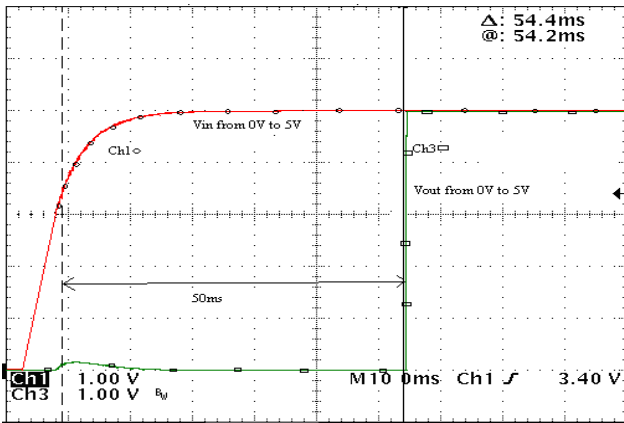

Figure 7. Startup
 $V_{in} = \text{Ch1}$, $V_{out} = \text{Ch3}$

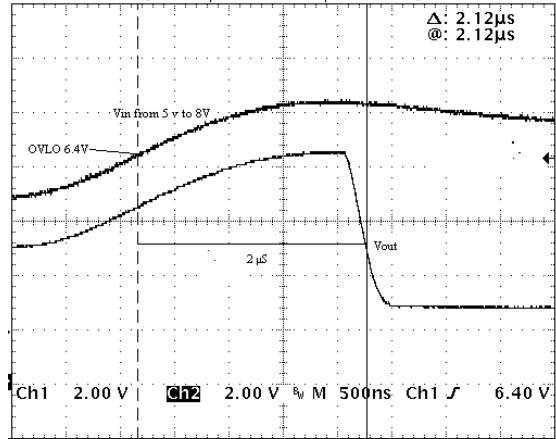

Figure 8. Output Turn Off Time
 $V_{in} = \text{Ch1}$, $V_{out} = \text{Ch2}$

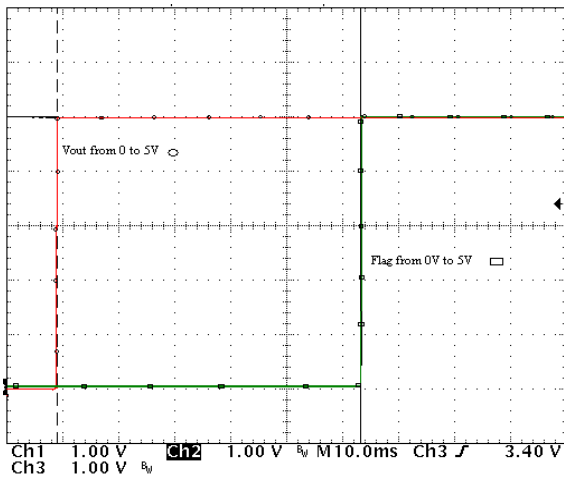

Figure 9. FLAG Going Up Delay
 $V_{out} = \text{Ch3}$, FLAG = Ch2

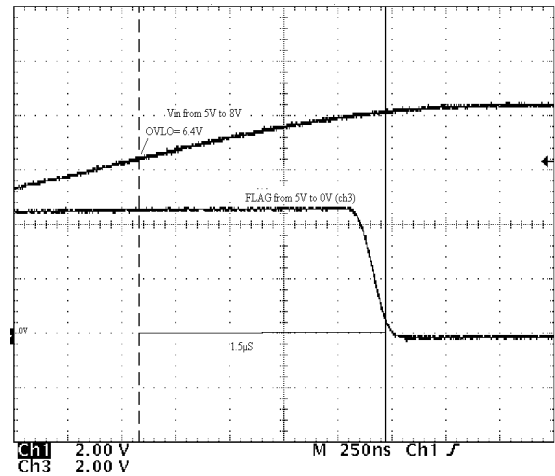

Figure 10. Alert Delay
 $V_{out} = \text{Ch1}$, FLAG = Ch3

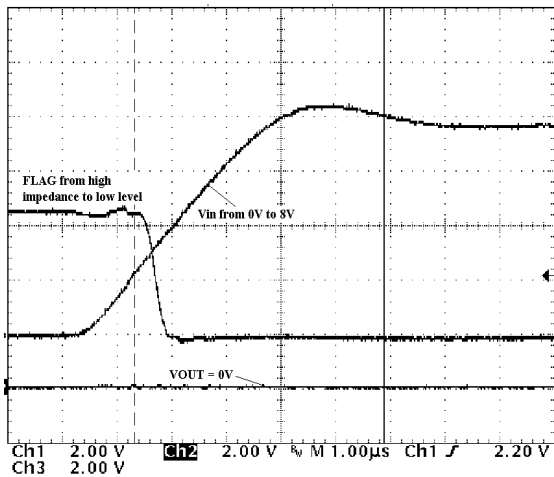

Figure 11. Initial Overvoltage Delay
 $V_{in} = \text{Ch1}$, $V_{out} = \text{Ch2}$, FLAG = Ch3



Figure 12. Disable Time
 $\text{EN} = \text{Ch1}$, $V_{out} = \text{Ch2}$, FLAG = Ch3

NCP347

TYPICAL OPERATING CHARACTERISTICS



Figure 13. Inrush Current with $C_{out} = 100 \mu F$, $I_{charge} = 1 A$, Output Wall Adaptor Inductance $1 \mu H$



Figure 14. Output Short Circuit



Figure 15. Output Short Circuit (Zoom Fig. 14)

NCP347



Figure 16. Simplified Diagram



Figure 17. Simplified Diagram

Operation

The NCP347 provides overvoltage protection for positive voltage, up to 28 V. A Low $R_{DS(on)}$ NMOS FET protects the systems (i.e.: charger) connected on the V_{out} pin, against positive overvoltage. At powerup, with \overline{EN} pin = low, the output is rising up 50 ms after the input

overtaking undervoltage UVLO (Figure 3). The NCP347 provides a \overline{FLAG} output, which alerts the system that a fault has occurred. A 50 ms additional delay, regarding available output (Figure 3) is added between output signal rising up and to \overline{FLAG} signal rising up. \overline{FLAG} pin is an open drain output.

NCP347



Figure 18. State Machine

Undervoltage Lockout (UVLO)

To ensure proper operation under any conditions, the device has a built-in undervoltage lockout (UVLO) circuit. During V_{in} positive going slope, the output remains disconnected from input until V_{in} voltage is below 2.92 V, plus hysteresis, nominal. The \overline{FLAG} output is tied to low as long as V_{in} does not reach UVLO threshold. This circuit has a 60 mV hysteresis to provide noise immunity to transient condition. Additional UVLO thresholds ranging from UVLO can be manufactured. (See Selection Guide on page 12) Contact your ON Semiconductor representative for availability.

Overvoltage Lockout (OVLO)

To protect connected systems on V_{out} pin from overvoltage, the device has a built-in overvoltage lockout (OVLO) circuit. During overvoltage condition, the output remains disabled as long as the input voltage exceeds 5.675 V typical (NCP347MTAE). Additional OVLO thresholds ranging from OVLO can be manufactured. (See Selection Guide on page 12) Contact your ON Semiconductor representative for availability.

\overline{FLAG} output is tied to low until V_{in} is higher than OVLO. This circuit has a 90 mV hysteresis to provide noise immunity to transient conditions.

\overline{FLAG} Output

The NCP347 provides a \overline{FLAG} output, which alerts external systems that a fault has occurred.

This pin is tied to low as soon the OVLO threshold is exceeded or when the V_{in} level is below the UVLO threshold. When V_{in} level recovers normal condition, \overline{FLAG} is held high, keeping in mind that an additional 50 ms delay has been added between available output and \overline{FLAG} = high. The pin is an open drain output, thus a pull up resistor (typically 1 M Ω , minimum 10 k Ω) must be added to V_{bat} . Minimum V_{bat} supply must be 2.5 V. The \overline{FLAG} level will always reflects V_{in} status, even if the device is turned off (\overline{EN} = 1).

\overline{EN} Input

To enable normal operation, the \overline{EN} pin shall be forced to low or connected to ground. A high level on the pin, disconnects OUT pin from IN pin. \overline{EN} does not overdrive an OVLO or UVLO fault.

Internal NMOS FET

The NCP347 includes an internal Low $R_{DS(on)}$ NMOS FET to protect the systems, connected on OUT pin, from positive overvoltage. Regarding electrical characteristics, the $R_{DS(on)}$, during normal operation, will create low losses on V_{out} pin.

As example: $R_{load} = 8.0 \Omega$, $V_{in} = 5.0 V$

Typical $R_{DS(on)} = 65 m\Omega$, $I_{out} = 618 mA$

$V_{out} = 8 \times 0.618 = 4.95 V$

NMOS losses = $R_{DS(on)} \times I_{out}^2 = 0.065 \times 0.618^2 = 25 mW$

ESD Tests

The NCP347 input pin fully supports the IEC61000-4-2. 1.0 μF (minimum) must be connected between V_{in} and GND, close to the device.

That means, in Air condition, V_{in} has a $\pm 15 kV$ ESD protected input. In Contact condition, V_{in} has $\pm 8.0 kV$ ESD protected input.

Please refer to Figure 19 to see the IEC 61000-4-2 electrostatic discharge waveform.

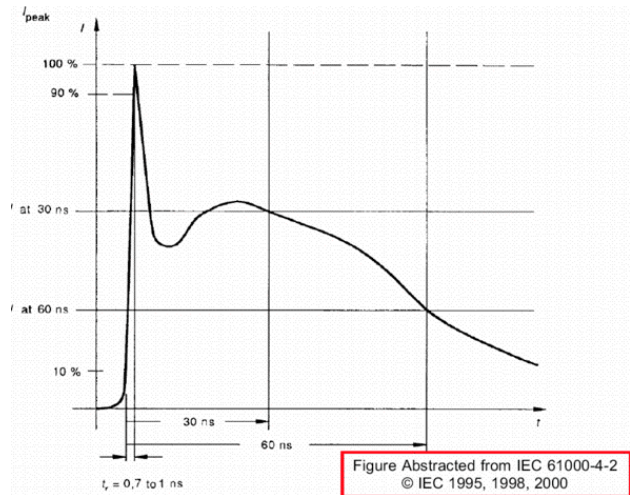

Figure 19. Electrostatic Discharge Waveform

PCB Recommendations

The NCP347 integrates a 2 amperes rated NMOS FET, and the PCB rules must be respected to properly evacuate the heat out of the silicon. The PAD1 is internally isolated from the active silicon and should preferably be connected to ground. The PAD2 of the NCP347 package is connected to the internal NMOS drain and can be used to increase the heat transfer if necessary from an applications standpoint.

Depending upon the power dissipated in the application, one can either use the PCB tracks connected to Pins 4 and 5 to evacuate heat, or make profit of the PAD2 area to add extra copper surface to reduce the junction temperature (See Figure 20). Of course, in any case, this pad shall be not connected to any other potential. Figure 20 shows copper area according to $R_{\theta JA}$ and allows the design of the heat transfer plane connected to PAD2.

NCP347

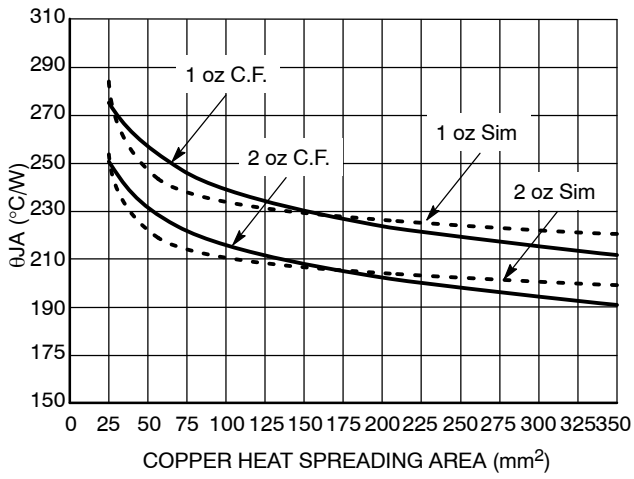

Figure 20.

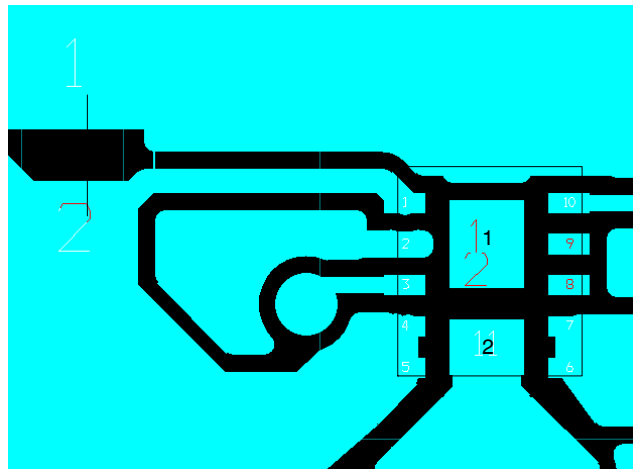

Figure 21. Demo Board Layout

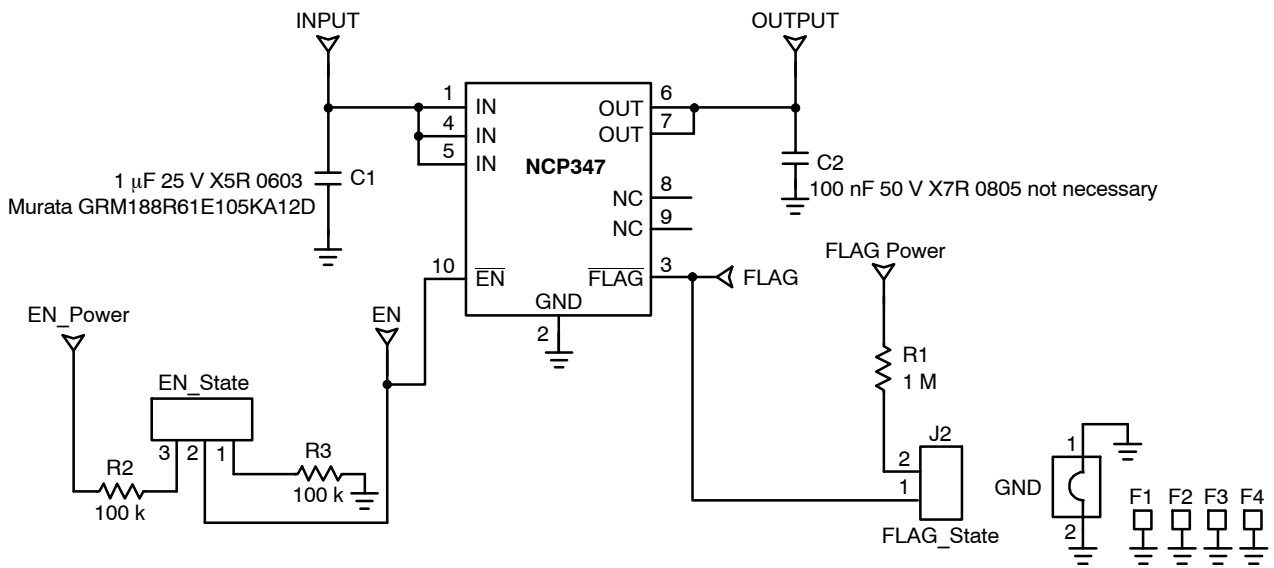

Figure 22. Demo Board Schematic

NCP347

ORDERING INFORMATION

Device	Marking	Package	Shipping†
NCP347MTAETBG	BAL	WDFN-10 (Pb-Free)	3000 / Tape & Reel
NCP347MTAFTBG	BAM		
NCP347MTAHTBG	BAK		
NCP347MTAITBG	ACJ		

†For information on tape and reel specifications, including part orientation and tape sizes, please refer to our Tape and Reel Packaging Specifications Brochure, BRD8011/D.

SELECTION GUIDE

The NCP347 can be available in several undervoltage and overvoltage thresholds versions. Part number is designated as follows:

NCP347MTxxTxG

↑ ↑ ↑
a b c

Code	Contents
a	UVLO Typical Threshold a: A = 2.95 V
b	OVLO Typical Threshold b: E = 5.63 V b: F = 5.90 V b: H = 7.20 V b: I = 5.85 V
c	Tape & Reel Type c: B = 3000

NCP347

PACKAGE DIMENSIONS

WDFN10, 2.5x2, 0.5P
CASE 516AA-01
ISSUE C

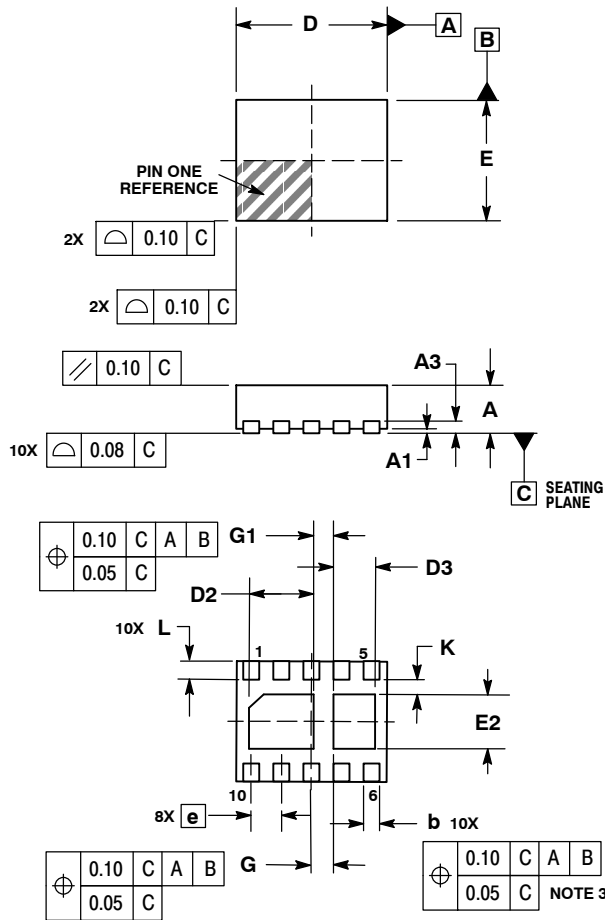

NOTES:

1. DIMENSIONING AND TOLERANCING PER ASME Y14.5M, 1994.
2. CONTROLLING DIMENSION: MILLIMETERS.
3. DIMENSION b APPLIES TO PLATED TERMINAL AND IS MEASURED BETWEEN 0.15 AND 0.30mm FROM TERMINAL.
4. COPLANARITY APPLIES TO THE EXPOSED PAD AS WELL AS THE TERMINALS.

DIM	MILLIMETERS		
	MIN	NOM	MAX
A	0.70	0.75	0.80
A1	0.00	---	0.05
A3	0.20 REF		
b	0.20	0.25	0.30
D	2.50 BSC		
D2	0.97	1.08	1.18
D3	0.57	0.68	0.78
e	0.50 BSC		
E	2.00 BSC		
E2	0.80	0.90	1.00
G	0.375 BSC		
G1	0.35 BSC		
K	0.20	---	---
L	0.20	0.30	0.40

SOLDERING FOOTPRINT*

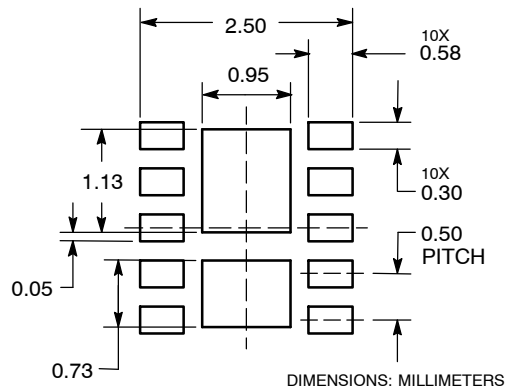

*For additional information on our Pb-Free strategy and soldering details, please download the ON Semiconductor Soldering and Mounting Techniques Reference Manual, SOLDERRM/D.

ON Semiconductor and are registered trademarks of Semiconductor Components Industries, LLC (SCILLC). SCILLC reserves the right to make changes without further notice to any products herein. SCILLC makes no warranty, representation or guarantee regarding the suitability of its products for any particular purpose, nor does SCILLC assume any liability arising out of the application or use of any product or circuit, and specifically disclaims any and all liability, including without limitation special, consequential or incidental damages. "Typical" parameters which may be provided in SCILLC data sheets and/or specifications can and do vary in different applications and actual performance may vary over time. All operating parameters, including "Typicals" must be validated for each customer application by customer's technical experts. SCILLC does not convey any license under its patent rights nor the rights of others. SCILLC products are not designed, intended, or authorized for use as components in systems intended for surgical implant into the body, or other applications intended to support or sustain life, or for any other application in which the failure of the SCILLC product could create a situation where personal injury or death may occur. Should Buyer purchase or use SCILLC products for any such unintended or unauthorized application, Buyer shall indemnify and hold SCILLC and its officers, employees, subsidiaries, affiliates, and distributors harmless against all claims, costs, damages, and expenses, and reasonable attorney fees arising out of, directly or indirectly, any claim of personal injury or death associated with such unintended or unauthorized use, even if such claim alleges that SCILLC was negligent regarding the design or manufacture of the part. SCILLC is an Equal Opportunity/Affirmative Action Employer. This literature is subject to all applicable copyright laws and is not for resale in any manner.

PUBLICATION ORDERING INFORMATION

LITERATURE FULFILLMENT:
Literature Distribution Center for ON Semiconductor
P.O. Box 5163, Denver, Colorado 80217 USA
Phone: 303-675-2175 or 800-344-3860 Toll Free USA/Canada
Fax: 303-675-2176 or 800-344-3867 Toll Free USA/Canada
Email: orderlit@onsemi.com

N. American Technical Support: 800-282-9855 Toll Free
USA/Canada
Europe, Middle East and Africa Technical Support:
Phone: 421 33 790 2910
Japan Customer Focus Center
Phone: 81-3-5773-3850

ON Semiconductor Website: www.onsemi.com
Order Literature: <http://www.onsemi.com/orderlit>

For additional information, please contact your local Sales Representative

Компания «Life Electronics» занимается поставками электронных компонентов импортного и отечественного производства от производителей и со складов крупных дистрибьюторов Европы, Америки и Азии.

С конца 2013 года компания активно расширяет линейку поставок компонентов по направлению коаксиальный кабель, кварцевые генераторы и конденсаторы (керамические, пленочные, электролитические), за счёт заключения дистрибьюторских договоров

Мы предлагаем:

- Конкурентоспособные цены и скидки постоянным клиентам.
- Специальные условия для постоянных клиентов.
- Подбор аналогов.
- Поставку компонентов в любых объемах, удовлетворяющих вашим потребностям.
- Приемлемые сроки поставки, возможна ускоренная поставка.
- Доставку товара в любую точку России и стран СНГ.
- Комплексную поставку.
- Работу по проектам и поставку образцов.
- Формирование склада под заказчика.
- Сертификаты соответствия на поставляемую продукцию (по желанию клиента).
- Тестирование поставляемой продукции.
- Поставку компонентов, требующих военную и космическую приемку.
- Входной контроль качества.
- Наличие сертификата ISO.

В составе нашей компании организован Конструкторский отдел, призванный помогать разработчикам, и инженерам.

Конструкторский отдел помогает осуществить:

- Регистрацию проекта у производителя компонентов.
- Техническую поддержку проекта.
- Защиту от снятия компонента с производства.
- Оценку стоимости проекта по компонентам.
- Изготовление тестовой платы монтаж и пусконаладочные работы.



Тел: +7 (812) 336 43 04 (многоканальный)

Email: org@lifeelectronics.ru