

**60V Two Terminal Constant Current LED Driver**
**NEW PRODUCT**
**Description**

The AL5809 is a constant current linear LED driver and provides a cost-effective two pin solution. It has an excellent temperature stability of 20 ppm/°C and current accuracy  $\pm 5\%$  regulated over a wide voltage and temperature range. The AL5809 comes in various fixed output current versions removing the need for external current setting resistors creating a simple solution for the linear driving of LEDs. It supports both the high-side and low-side driving of LED chains.

The AL5809 turns on immediately and can swing from 2.5V up to 60V enabling drive long LED chains. The floating ground, 60V voltage rating between input and output pins designed to withstand the high peak voltage incurred in offline applications.

The AL5809 is available in thermally robust package POWERDI-123 or SOD-123 package.

**Features**

- Robust power package up to 1.2W for POWERDI-123
- -40°C to +125°C temperature range
- $\pm 5\%$  LED current tolerance over temperature
- (15mA, 20mA, 30mA, 40mA, 50mA, 60mA, 90mA, 120mA, and 150mA) available in POWERDI-123 package
- (15mA, 20mA, 30mA, 40mA and 50mA) available in SOD-123 package, and other current options available by request
- Constant current with low temperature drift and high power supply rejection ratio
- 2.5V to 60V operating voltage between two terminals.
- Available in PowerDi-123 and SOD-123 in **“Green” Molding Compound (No Br, Sb) (Note 1) with Lead-Free Finish/RoHS Compliant (Notes 2 & 3)**

Notes: 1. Halogen- and Antimony-free "Green" products are defined as those which contain <900ppm bromine, <900ppm chlorine (<1500ppm total Br + Cl) and <1000ppm antimony compounds.  
 2. No purposely added lead. Fully compliant EU Directive 2002/95/EC (RoHS) & 2011/65/EU (RoHS 2).  
 3. See <http://www.diodes.com> for more information about Diodes Incorporated's definitions of Halogen- and Antimony-free, "Green" and Lead-free.

**Pin Assignments**

**Applications**

- Offline LED Lamps
- LED Power Supplies
- White Goods
- LED Signs
- Instrumentation Illumination

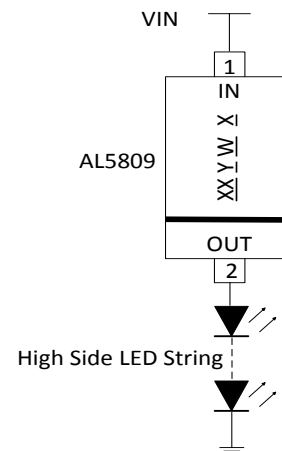
**Typical Applications Circuit**

**Pin Descriptions**

Pin Name	Pin Number (PowerDi-123)	Function
In	1	LED current input terminal. For low side LED string application, connect the LED cathode terminal to the "In" terminal. For high side LED string application, connect the LED anode terminal to the "Out" terminal.
Out	2	LED Current Output terminal. For low side LED string application, connect the LED anode terminal to the "Out" terminal. For high side LED string application, connect the LED cathode terminal to the "Out" terminal.

**Functional Block Diagram**



**Absolute Maximum Ratings**

Symbol	Parameters	Ratings	Unit
$V_{InOut}$	"In" Voltage Relative to "Out" Pin	80	V
$I_{InOut}$	LED Current from "In" to "Out"	180	mA
ESD HBM	Human Body Model ESD Protection	4	kV
ESD MM	Machine Model ESD Protection	400	V
$T_J$	Operating Junction Temperature	-40 to +175	°C
$T_{ST}$	Storage Temperature	-55 to +150	°C

Caution: Stresses greater than the 'Absolute Maximum Ratings' specified above, may cause permanent damage to the device. These are stress ratings only; functional operation of the device at these or any other conditions exceeding those indicated in this specification is not implied. Device reliability may be affected by exposure to absolute maximum rating conditions for extended periods of time.

Semiconductor devices are ESD sensitive and may be damaged by exposure to ESD events. Suitable ESD precautions should be taken when handling and transporting these devices.

## Package Thermal Data

Package	$\theta_{JC}$ Thermal Resistance Junction-to-Case	$\theta_{JA}$ Thermal Resistance Junction-to-Ambient	$P_{DIS}$ $T_A = +25^\circ\text{C}, T_J = +125^\circ\text{C}$
PowerDi-123	27.15°C/W	148.61°C/W (Note 4)	0.68W
PowerDi-123	17.81°C/W	81.39°C/W (Note 5)	1.24W
SOD-123	69.56°C/W	278.42°C/W (Note 6)	0.36W

Notes:

4. Test condition for PowerDi-123: Device mounted on 25.4mm x 25.4mm FR-4 PCB (10mm x 10mm 1oz copper, minimum recommended pad layout on top layer and thermal vias to bottom layer ground plane). For better thermal performance, larger copper pad for heatsink is needed.
5. When mounted on 50.8mm x 50.8mm GETEK PCB with 25.4mm x 25.4mm copper pads.
6. Test condition for SOD-123: Device mounted on FR-4 PCB with 50.8mm x 50.8mm 2oz copper, minimum recommended pad layout on top layer and thermal vias to bottom layer with maximum area ground plane. For better thermal performance, larger copper pad for heatsink is needed.

## Recommended Operating Conditions

Symbol	Parameter	Min	Max	Unit
$V_{InOut}$	"In" Voltage Range Relative to "Out" Pin	2.5	60	V
$I_{InOut}$	LED Current (Note 7)	15	150	mA
$T_A$	Operating Ambient Temperature Range (Note 8)	-40	+125	°C

Notes:

7. The LED operating current is determined by the AL5809 current option index XXX, AL5809-XXXS/P1-7.
8. The Maximum LED current is also limited by ambient temperature and power dissipation such that junction temperature should be kept less than or equal to +125°C.

## Electrical Characteristics ( $V_{InOut} = 3.5\text{V}$ ) (Note 9)

Symbol	Parameter	Conditions	Min	Typ	Max	Unit	
$V_{InOut}$	In-Out Supply Voltage	$T_A = -40^\circ\text{C to } +125^\circ\text{C}$	2.5	—	60	V	
$I_{InOut}$	LED Current Accuracy (±5% for over temperature)	AL5809-15S1-7 AL5809-15P1-7	$T_A = -40^\circ\text{C to } +125^\circ\text{C}$	14.25	15	15.75	mA
		AL5809-20S1-7 AL5809-20P1-7	$T_A = -40^\circ\text{C to } +125^\circ\text{C}$	19	20	21	
		AL5809-30S1-7 AL5809-30P1-7	$T_A = -40^\circ\text{C to } +125^\circ\text{C}$	28.5	30	31.5	
		AL5809-40S1-7 AL5809-40P1-7	$T_A = -40^\circ\text{C to } +125^\circ\text{C}$	38	40	42	
		AL5809-50S1-7 AL5809-50P1-7	$T_A = -40^\circ\text{C to } +125^\circ\text{C}$	47.5	50	52.5	
		AL5809-60P1-7	$T_A = -40^\circ\text{C to } +125^\circ\text{C}$	57	60	63	
		AL5809-90P1-7	$T_A = -40^\circ\text{C to } +125^\circ\text{C}$	85.5	90	94.5	
		AL5809P-1201-7	$T_A = -40^\circ\text{C to } +125^\circ\text{C}$	114	120	126	
		AL5809-150P1-7	$T_A = -40^\circ\text{C to } +125^\circ\text{C}$	142.5	150	157.5	
$I_{LINE}$	$I_{InOut}$ Current Line Regulation	$V_{InOut} = 2.5\text{V to } 60\text{V}$ (Note 10)	$T_A = +25^\circ\text{C}$	—	1	%/V	
$V_{MIN}$	Minimum Power Up Voltage	Increase $V_{InOut}$ (Note 11)	$T_A = -40^\circ\text{C to } +125^\circ\text{C}$	1	1.5	2	V
$T_{SHDN}$	Thermal Shutdown	—	—	—	145	—	°C
$T_{HYS}$	Thermal Shutdown Hysteresis	—	—	—	30	—	°C

Notes:

9. All voltages unless otherwise stated are measured with respect to OUT pin.
10. Measure the percentage degree of LED current variation when  $V_{InOut}$  varies from 2.5V to 60V for each current option.
11. Apply the power linearly to the chip until the device starts to turn on.

**Application Information**

**Description**

The AL5809 is a constant current linear LED driver and can be placed in series with LEDs as a High Side or a Low Side constant current regulator. The AL5809 offers various current settings from 15mA up to 150mA and different current settings available upon request (contact: Diodes local sale office at <http://www.diodes.com>).

**Simple LED String**

The AL5809 can be placed in series with LEDs as a Low Side/High Side constant current regulator. The number of LEDs can vary from one to as many as supported by the input supply voltage. The designer needs to calculate the maximum voltage between In and Out by taking the maximum input voltage less the voltage across the LED string (Figures 1 and 2).



**Figure 1 Low Side LED String Tapping**



**Figure 2 High Side LED String Tapping**

The AL5809 can also be used on the high side of the LEDs, see Figure 2. The minimum system input voltage can be calculated by:

$$V_{IN(min)} = V_{LED\_CHAIN} + 2.5V \quad \text{Where } V_{LED\_CHAIN} \text{ is the LED chain voltage.}$$

The LED current can be increased by connecting two or more AL5809 in parallel shown in Figure 3.



**(a) Low Side Configuration**

**(b) High Side Configuration**

**Figure 3 Higher LED current by parallel configuration of AL5809**

NEW PRODUCT

**PWM Dimming**

The AL5809 can be used to provide LED current dimming driving the Out pin via the MOSFET switch to ground (Figure 4). The Out pin current is then effectively switched on and off causing the LED current to turn on and off.



(a) PWM Dimming by External MOSFET

(b) PWM Dimming by Power Supply VIN ON/OFF

Figure 4 PWM Dimming

**Typical Performance Characteristics (15mA, 20mA, 30mA, 40mA, 50mA) PDI options**



Figure 5 LED Current vs. VInOut



Figure 6 Startup Minimum Operating Voltage



Figure 7 LED Current vs. Ambient Temperature

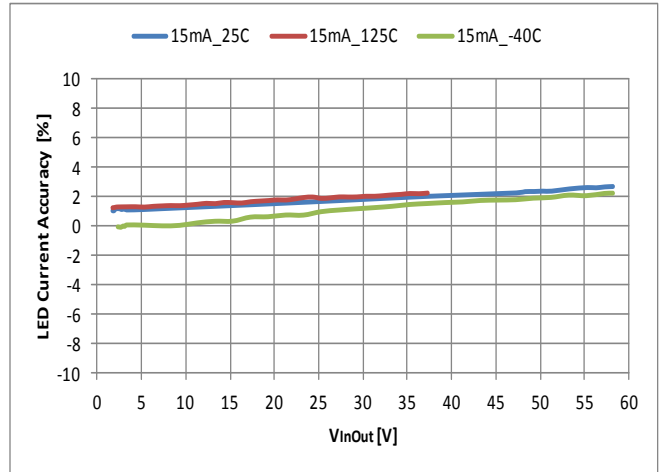

Figure 8 LED Current Accuracy (%) vs. VInOut across Temperature



Figure 9 THSD of 20mA Current Option



Figure 10 THSD of 40mA Current Option

**Typical Performance Characteristics (60mA, 90mA, 150mA) PDI options**



Figure 11 LED Current vs. VinOut



Figure 12 Startup Minimum Operating Voltage



Figure 13 LED Current across Temperature



Figure 14 LED Current Accuracy (%) vs. VinOut across Temperature



Figure 15 THSD of 60mA Current Option



Figure 16 THSD of 150mA Current Option

**Typical Performance Characteristics**



Figure 17 Power Dissipation vs. Ambient Temperature @  $T_J = 145^\circ\text{C}$



Figure 18 Maximum  $V_{InOut}$  vs. Temperature



Figure 19 Maximum  $V_{InOut}$  vs. Temperature



Figure 20 PWM Dimming 90mA vs. Duty Cycle



Figure 21 PWM Dimming 150mA vs. Duty Cycle

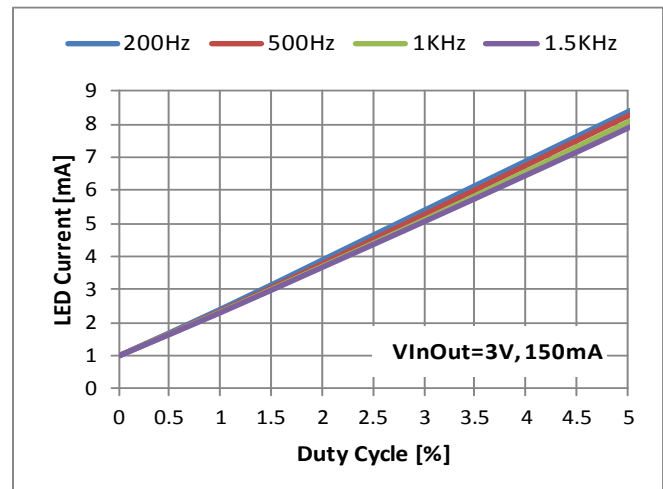

Figure 22 Area Zoom In within Duty Cycle 5% of Figure 21



Ordering Information

AL5809 - XXX XX - 7



NEW PRODUCT



Part Number	LED Current Opion	Package Code	Packaging (Notes 12 & 13)	7" Tape and Reel	
				Quantity	Part Number Suffix
AL5809-15P1-7	15mA	P1	PDI123	3000/ Tape & Reel	-7
AL5809-20P1-7	20mA	P1	PDI123	3000/ Tape & Reel	-7
AL5809-30P1-7	30mA	P1	PDI123	3000/ Tape & Reel	-7
AL5809-40P1-7	40mA	P1	PDI123	3000/ Tape & Reel	-7
AL5809-50P1-7	50mA	P1	PDI123	3000/ Tape & Reel	-7
AL5809-60P1-7	60mA	P1	PDI123	3000/ Tape & Reel	-7
AL5809-90P1-7	90mA	P1	PDI123	3000/ Tape & Reel	-7
AL5809-120P1-7	120mA	P1	PDI123	3000/ Tape & Reel	-7
AL5809-150P1-7	150mA	P1	PDI123	3000/ Tape & Reel	-7
AL5809-15S1-7	15mA	S1	SOD-123	3000/ Tape & Reel	-7
AL5809-20S1-7	20mA	S1	SOD-123	3000/ Tape & Reel	-7
AL5809-30S1-7	30mA	S1	SOD-123	3000/ Tape & Reel	-7
AL5809-40S1-7	40mA	S1	SOD-123	3000/ Tape & Reel	-7
AL5809-50S1-7	50mA	S1	SOD-123	3000/ Tape & Reel	-7

Notes: 12. EU Directive 2002/95/EC (RoHS). All applicable RoHS exemptions applied. Please visit our website at [http://www.diodes.com/products/lead\\_free.html](http://www.diodes.com/products/lead_free.html).  
 13. Pad layout as shown on Diodes Inc. suggested pad layout document AP02001, which can be found on our website at <http://www.diodes.com/datasheets/ap02001.pdf>.

**Marking Information**

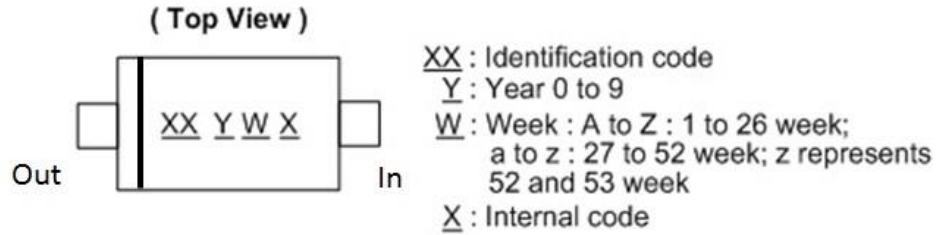

Part Number	Package	Identification Code
AL5809-15P1-7	PDI123	C1
AL5809-20P1-7	PDI123	C2
AL5809-30P1-7	PDI123	C3
AL5809-40P1-7	PDI123	C4
AL5809-50P1-7	PDI123	C5
AL5809-60P1-7	PDI123	C6
AL5809-90P1-7	PDI123	C7
AL5809-120P1-7	PDI123	C8
AL5809-150P1-7	PDI123	C9
AL5809-15S1-7	SOD-123	D1
AL5809-20S1-7	SOD-123	D2
AL5809-30S1-7	SOD-123	D3
AL5809-40S1-7	SOD-123	D4
AL5809-50S1-7	SOD-123	D5

**Package Outline Dimensions** (All dimensions in mm.)

Please see AP02002 at <http://www.diodes.com/datasheets/ap02002.pdf> for the latest version.

**(1) PowerDI-123 type B**



POWERDI <sup>®</sup> 123B			
Dim	Min	Max	Typ
A	3.50	3.90	3.70
B	2.60	3.00	2.80
C	1.63	1.93	1.78
D	0.93	1.00	0.98
E	0.85	1.25	1.00
H	0.15	0.25	0.20
L	0.50	0.80	0.65
All Dimensions in mm			

**Package Outline Dimensions** (All dimensions in mm.) (cont.)

**(2) SOD-123**



SOD123		
Dim	Min	Max
A	0.55 Typ	
B	1.40	1.70
C	3.55	3.85
H	2.55	2.85
J	0.00	0.10
K	1.00	1.35
L	0.25	0.40
M	0.10	0.15
α	0	8°
All Dimensions in mm		

**Suggested Pad Layout**

Please see AP02001 at <http://www.diodes.com/datasheets/ap02001.pdf> for the latest version.

**(1) PowerDI-123 (Use PowerDI-123 B type Pad Layout)**

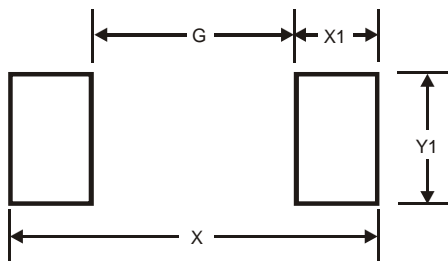

Dimensions	Value (in mm)
G	2.000
X	4.100
X1	1.050
Y1	1.500

**(2) SOD-123**

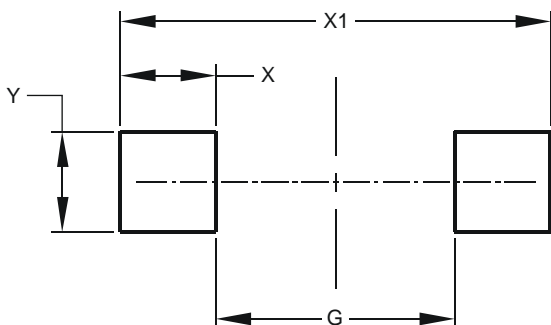

Dimensions	Value (in mm)
G	2.250
X	0.900
X1	4.050
Y	0.950

**Taping Orientation**

The taping orientation of the other package type can be found on our website at <http://www.diodes.com/datasheets/ap02007.pdf>.

(1) PowerDI-123 Type B



(2) SOD-123



NEW PRODUCT

**IMPORTANT NOTICE**

DIODES INCORPORATED MAKES NO WARRANTY OF ANY KIND, EXPRESS OR IMPLIED, WITH REGARDS TO THIS DOCUMENT, INCLUDING, BUT NOT LIMITED TO, THE IMPLIED WARRANTIES OF MERCHANTABILITY AND FITNESS FOR A PARTICULAR PURPOSE (AND THEIR EQUIVALENTS UNDER THE LAWS OF ANY JURISDICTION).

Diodes Incorporated and its subsidiaries reserve the right to make modifications, enhancements, improvements, corrections or other changes without further notice to this document and any product described herein. Diodes Incorporated does not assume any liability arising out of the application or use of this document or any product described herein; neither does Diodes Incorporated convey any license under its patent or trademark rights, nor the rights of others. Any Customer or user of this document or products described herein in such applications shall assume all risks of such use and will agree to hold Diodes Incorporated and all the companies whose products are represented on Diodes Incorporated website, harmless against all damages.

Diodes Incorporated does not warrant or accept any liability whatsoever in respect of any products purchased through unauthorized sales channel. Should Customers purchase or use Diodes Incorporated products for any unintended or unauthorized application, Customers shall indemnify and hold Diodes Incorporated and its representatives harmless against all claims, damages, expenses, and attorney fees arising out of, directly or indirectly, any claim of personal injury or death associated with such unintended or unauthorized application.

Products described herein may be covered by one or more United States, international or foreign patents pending. Product names and markings noted herein may also be covered by one or more United States, international or foreign trademarks.

This document is written in English but may be translated into multiple languages for reference. Only the English version of this document is the final and determinative format released by Diodes Incorporated.

**LIFE SUPPORT**

Diodes Incorporated products are specifically not authorized for use as critical components in life support devices or systems without the express written approval of the Chief Executive Officer of Diodes Incorporated. As used herein:

A. Life support devices or systems are devices or systems which:

1. are intended to implant into the body, or
2. support or sustain life and whose failure to perform when properly used in accordance with instructions for use provided in the labeling can be reasonably expected to result in significant injury to the user.

B. A critical component is any component in a life support device or system whose failure to perform can be reasonably expected to cause the failure of the life support device or to affect its safety or effectiveness.

Customers represent that they have all necessary expertise in the safety and regulatory ramifications of their life support devices or systems, and acknowledge and agree that they are solely responsible for all legal, regulatory and safety-related requirements concerning their products and any use of Diodes Incorporated products in such safety-critical, life support devices or systems, notwithstanding any devices- or systems-related information or support that may be provided by Diodes Incorporated. Further, Customers must fully indemnify Diodes Incorporated and its representatives against any damages arising out of the use of Diodes Incorporated products in such safety-critical, life support devices or systems.

Copyright © 2014, Diodes Incorporated

[www.diodes.com](http://www.diodes.com)

Компания «Life Electronics» занимается поставками электронных компонентов импортного и отечественного производства от производителей и со складов крупных дистрибьюторов Европы, Америки и Азии.

С конца 2013 года компания активно расширяет линейку поставок компонентов по направлению коаксиальный кабель, кварцевые генераторы и конденсаторы (керамические, пленочные, электролитические), за счёт заключения дистрибьюторских договоров

Мы предлагаем:

- Конкурентоспособные цены и скидки постоянным клиентам.
- Специальные условия для постоянных клиентов.
- Подбор аналогов.
- Поставку компонентов в любых объемах, удовлетворяющих вашим потребностям.
- Приемлемые сроки поставки, возможна ускоренная поставка.
- Доставку товара в любую точку России и стран СНГ.
- Комплексную поставку.
- Работу по проектам и поставку образцов.
- Формирование склада под заказчика.
- Сертификаты соответствия на поставляемую продукцию (по желанию клиента).
- Тестирование поставляемой продукции.
- Поставку компонентов, требующих военную и космическую приемку.
- Входной контроль качества.
- Наличие сертификата ISO.

В составе нашей компании организован Конструкторский отдел, призванный помогать разработчикам, и инженерам.

Конструкторский отдел помогает осуществить:

- Регистрацию проекта у производителя компонентов.
- Техническую поддержку проекта.
- Защиту от снятия компонента с производства.
- Оценку стоимости проекта по компонентам.
- Изготовление тестовой платы монтаж и пусконаладочные работы.



Тел: +7 (812) 336 43 04 (многоканальный)

Email: [org@lifeelectronics.ru](mailto:org@lifeelectronics.ru)