

# POSITION DETECTORS

## Pressure decay sensor

> 100 % pneumatic

Also available in **ATEX** version for use in potentially explosive atmospheres in accordance with 94/9/EC Directive



Pressure decay sensor

81 504 025

**Symbol**

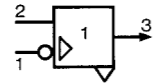

### Characteristics

Operating pressure	bar	2 → 8
Flow at 6 bars	NI/min	200
Tripping point with 6 bar supply	b	0.3
Connection		Sub-base page 54-55
Operating temperature	°C	-5 → +50
Mechanical life	operations	≥10 <sup>7</sup>
Weight	g	25

### Connections

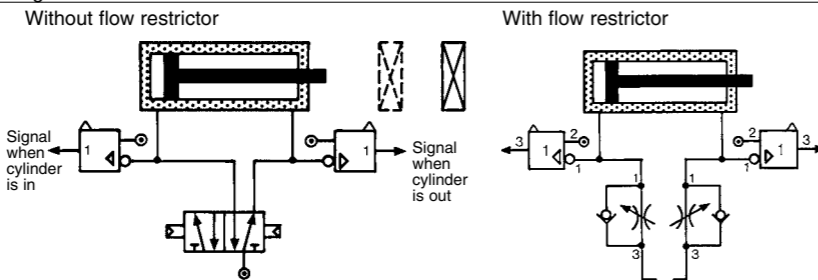

### Principle of operation

Fitted in-line between the cylinder and the control valve, the sensor will give an output when the pressure in this line is exhausted and the cylinder is at end of stroke.

For the correct usage of sensors on a falling pressure, it is recommended that the practical cylinder load is limited to 60% of the theoretical force.

Evolution of pressure within a double-acting cylinder

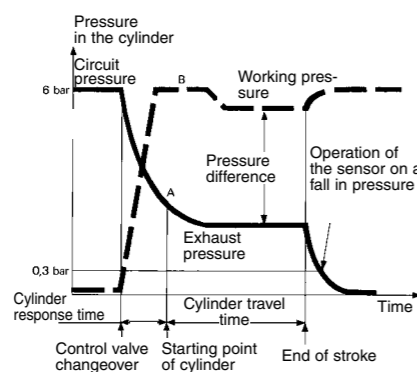

### Dimensions

81 504 025

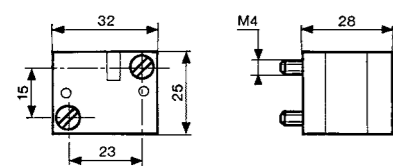

ATEX version products are available in the following catalogues: **Pneumatic products for explosive atmospheres** or on our website [www.crouzet.com](http://www.crouzet.com)

## Low force position detector

- > 100 % pneumatic
- > Conforme à la norme DIN 41365 Forme A
- > Faible effort d'actionnement < 50 g à 6 bars
- > Pas de consommation permanente d'air comprimé

Also available in **ATEX** version for use in potentially explosive atmospheres in accordance with 94/9/EC Directive

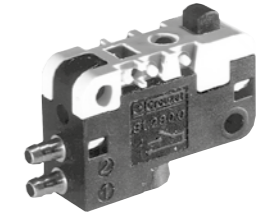

Function NO NC

81 290 501

81 290 001

**Symbol**

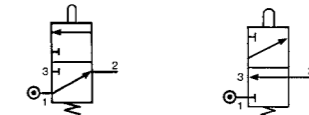

### Characteristics

Orifice diameter mm		2	2
Operating pressure	bar	3 → 8	3 → 8
Flow at 4 bars	NI/min	100	100
Activation force at 6 bars	N	< 0,5	< 0,5
Permissible fluids (air / inert gas)		•	•
Max/min of fluid temperatures operating	°C	-10 → +50	-10 → +50
storage	°C	-10 → +60	-10 → +60
	°C	-40 → +70	-40 → +70
Mechanical life at 6 bars	operation	10 <sup>7</sup>	10 <sup>7</sup>
Response time on activation	ms	≤ 15	≤ 15
on release	ms	≤ 15	≤ 15
Barb connection for semi-rigid tubing		2.7 x 4	2.7 x 4
Weight	g	8.5	8.5

### Principle of operation NC

Desactivated

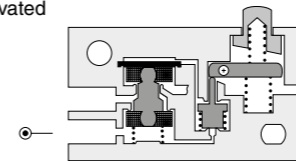

Activated

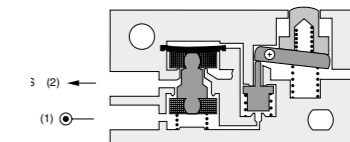

### Operation accessories

Unless otherwise requested, flat and roller-ended levers are supplied loose.

161 A  
flat R 25.4  
70 507 524

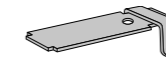

161 E  
with roller R 24.1  
70 507 529

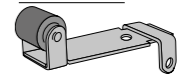

### Dimensions

DIN 41635 Form A

161 A  
R 25.4 ±0,2

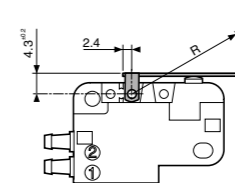

161 E  
R 24.1 ±0,2

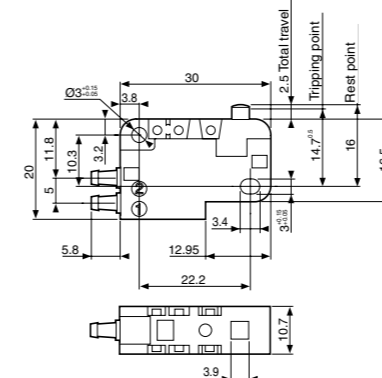
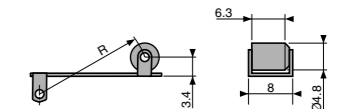

ATEX version products are available in the following catalogues: **Pneumatic products for explosive atmospheres** or on our website [www.crouzet.com](http://www.crouzet.com)

### “Microvalve” series position detectors

> 100 % pneumatic

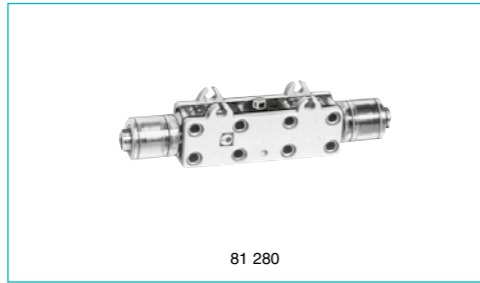

81 280



81 281

Version	NO	81 280 010	81 281 010	—
	NC	81 280 510	81 281 510	81 283 510
Features		Horizontal output	Vertical output	Rear connection by screw

**Symbol**

NO

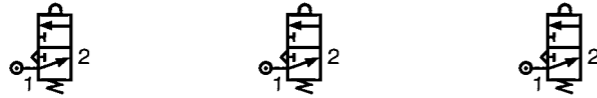

NC

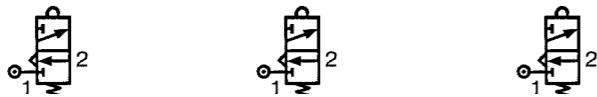

**Characteristics**

Operating pressure	bar	2 → 8	2 → 8	2 → 8
Orifice diameter	mm	2.7	2.7	—
Flow at 6 bars	NI/min	200	200	138
Operating force at 6 bars	N	15	15	15
Effective travel	mm	1	1	1
Push-in connection for semi-rigid tubing (NFE 49100)	mm	Ø 4	Ø 4	Ø 4
Operating temperature	°C	-5 → +50	-5 → +50	-5 → +50
Mechanical life	operat.	5 x 10 <sup>6</sup>	5 x 10 <sup>6</sup>	5 x 10 <sup>6</sup>
Weight	g	14	14	20

**Principle of operation**

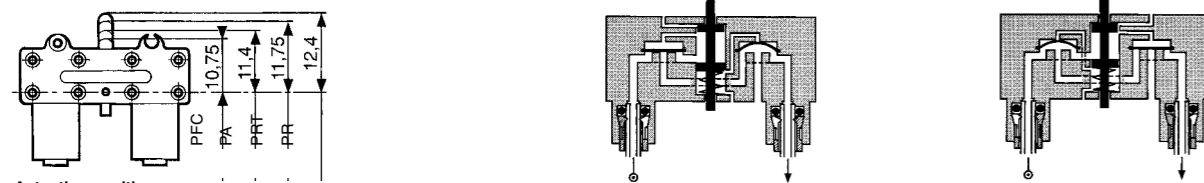

**Actuation positions :**

- PFC : End of travel position
- PA : Operating position (max output kV)
- PRT : Release position (max. exhaust kV)
- PR : Rest position

**Dimensions**

81 281 010 - 81 281 510

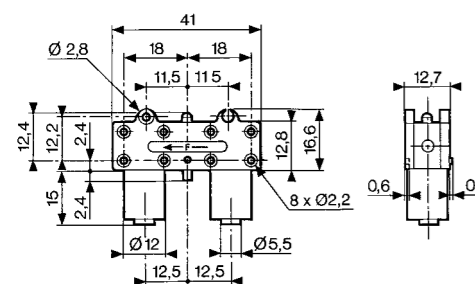

81 280 010 - 81 280 510

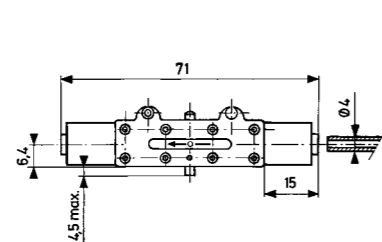

81 283 510

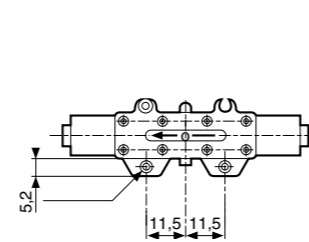

### “Microvalve” series position detectors

> 100 % pneumatic

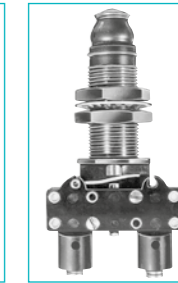
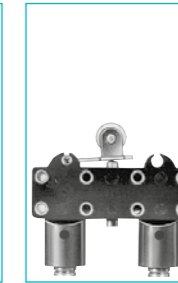
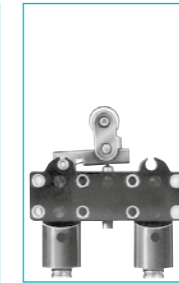
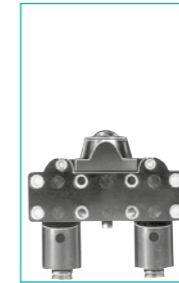
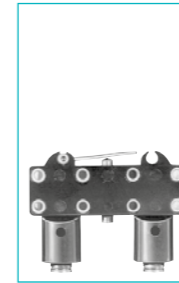

Features		Short lever	With ball	Roller trip	With roller	Threaded barrel Ø 16 Plunger	
Version	NC	Vertical output	81 281 502	81 281 504	81 281 508	81 281 509	81 737 501

**Symbol**

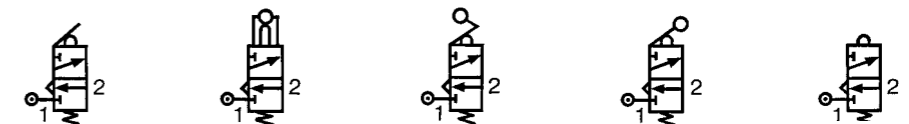

**Characteristics**

Operating pressure	bar	2 → 8	2 → 8	2 → 8	2 → 8	2 → 8
Orifice diameter	mm	2.7	2.7	2.7	2.7	2.7
Flow at 6 bars	NI/min	200	200	200	200	200
Operating force at 6 bars	N	15	15	15	15	25
Effective travel	mm	1	1	1	1	1
Push-in connection for semi-rigid tubing (NFE 49100)	mm	Ø 4	Ø 4	Ø 4	Ø 4	Ø 4
Operating temperature	°C	-5 → +50	-5 → +50	-5 → +50	-5 → +50	-5 → +50
Mechanical life	operat.	5 x 10 <sup>6</sup>	5 x 10 <sup>6</sup>	5 x 10 <sup>6</sup>	5 x 10 <sup>6</sup>	5 x 10 <sup>6</sup>
Weight	g	16	18	18	18	90

**Dimensions**

81 281 502

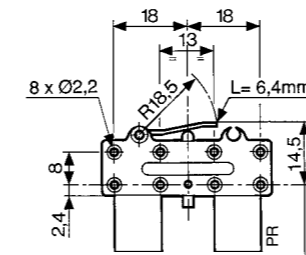

81 281 504

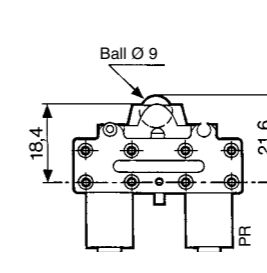

81 281 508

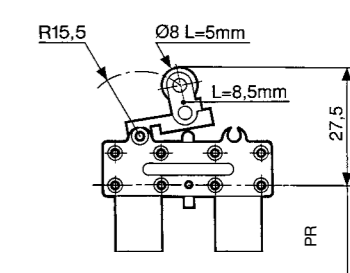

81 281 509

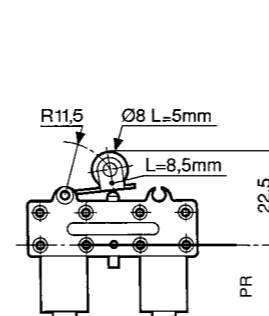

81 737 501

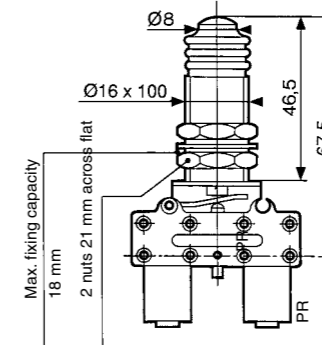

**Actuation positions :**  
PR : Rest position

### "Miniature" series position detectors

- > 100 % pneumatic
- > All metal

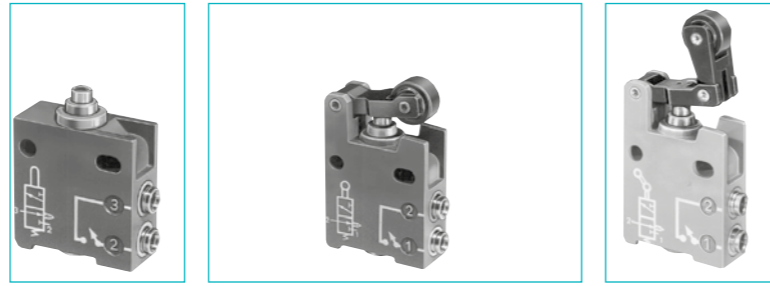

Part numbers		81 921 501	81 921 701	81 921 702	81 921 707
Version	Push-in connection for semi-rigid tubing (NFE 49100)				
NC	Ø 4 silenced exhaust	—	—	—	—
	M5 connectable exhaust	—	—	—	—
	Ø 4 connectable exhaust *	—	—	—	—
NO	Ø 6 connectable exhaust *	—	—	—	—
	Ø 4 silenced exhaust	—	—	—	—
Control	Ø 6 silenced exhaust	—	—	—	—
		Simple plunger	Lever with plastic roller	Lever with roller bearing	Lever with one-way trip plastic roller

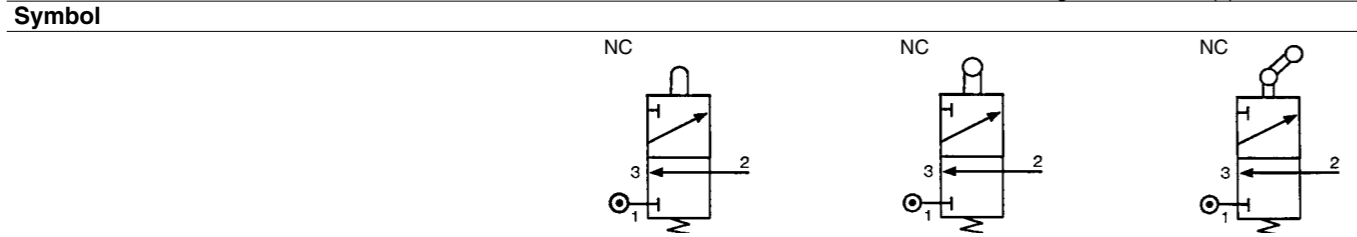

Characteristics		81 921 501	81 921 701	81 921 702	81 921 707
Operating pressure	bar	0.1 → 8	0.1 → 8	0.1 → 8	0.1 → 8
Orifice diameter	mm	2.7	2.7	2.7	2.7
Flow at 6 bars	NI/min	200	200	200	200
Actuation force at 6 bars	N	18	18	18	18
Circuit function : NC		•	•	•	•
Circuit function: NO		—	—	—	—
Connectable exhaust		—	—	—	—
Operating temperature	°C	-5 → +50	-5 → +50	-5 → +50	-5 → +50
Mechanical life	operations	≥10 <sup>7</sup>	≥10 <sup>7</sup>	≥10 <sup>7</sup>	≥10 <sup>7</sup>
Weight	g	62	75	80	77

**Principle of operation**

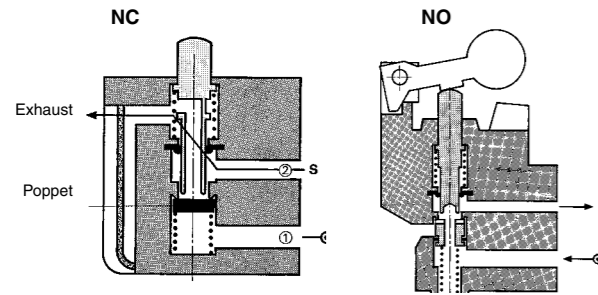

**Actuation travel**  
Vertical attack  
Simple plunger

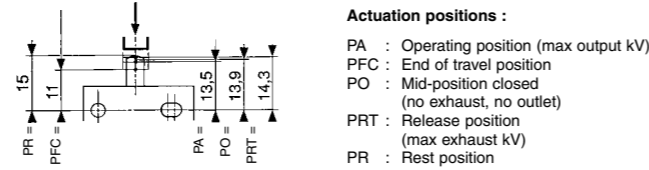

**Dimensions**

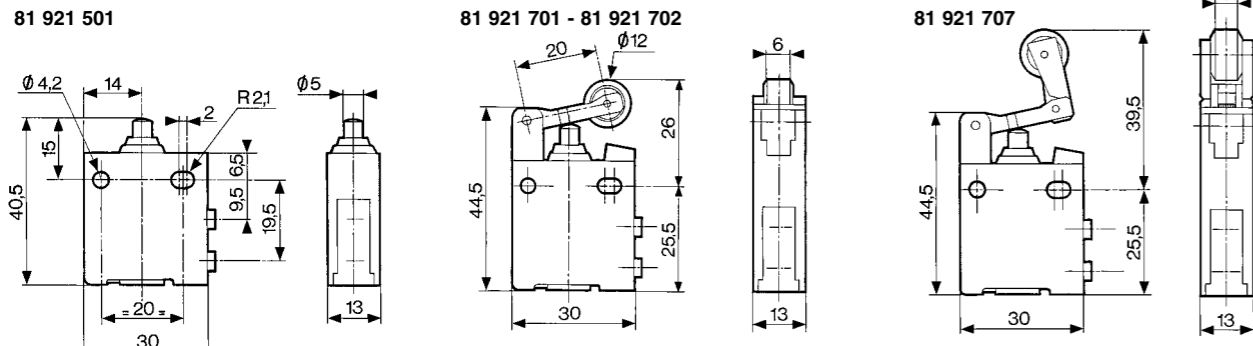

\* with barb for tube Ø 2.7 x 4  
**Material: body zamak**

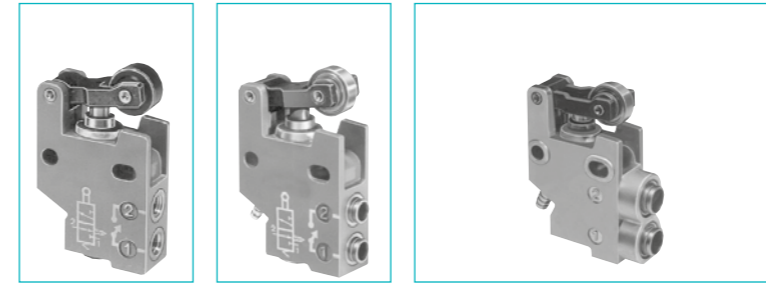

Part numbers		81 921 806	81 921 714	81 921 719	81 921 717
Version	Push-in connection for semi-rigid tubing (NFE 49100)				
NC	Ø 4 silenced exhaust	—	—	—	—
	M5 connectable exhaust	—	—	—	—
	Ø 4 connectable exhaust *	—	—	—	—
NO	Ø 6 connectable exhaust *	—	—	—	—
	Ø 4 silenced exhaust	—	—	—	—
Control	Ø 6 silenced exhaust	—	—	—	—
		Lever with plastic roller	Lever with roller bearing	Lever with plastic roller	Lever with roller bearing

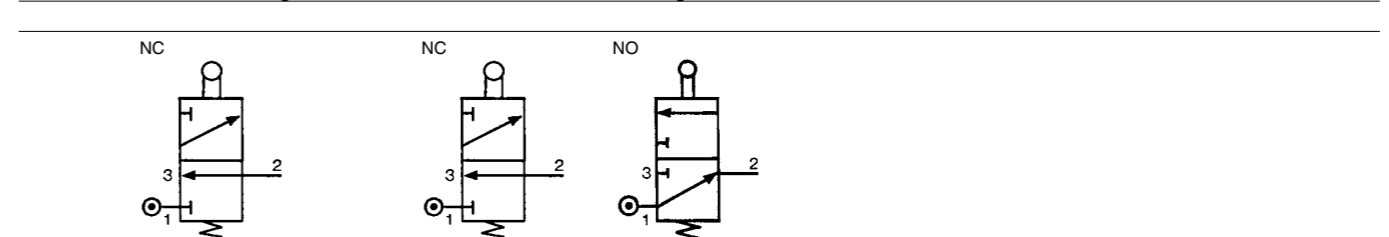

Characteristics		81 921 806	81 921 714	81 921 719	81 921 717
Operating pressure	bar	0.1 → 8	0.1 → 8	0.1 → 8	0.1 → 8
Orifice diameter	mm	2.7	2.7	2.7	2.7
Flow at 6 bars	NI/min	200	200	200	200
Actuation force at 6 bars	N	18	18	18	18
Circuit function : NC		•	•	•	•
Circuit function: NO		—	—	•	•
Connectable exhaust		—	—	—	—
Operating temperature	°C	-5 → +50	-5 → +50	-5 → +50	-5 → +50
Mechanical life	operations	≥10 <sup>7</sup>	≥10 <sup>7</sup>	≥10 <sup>7</sup>	≥10 <sup>7</sup>
Weight	g	75	80	100	100

**With lever**

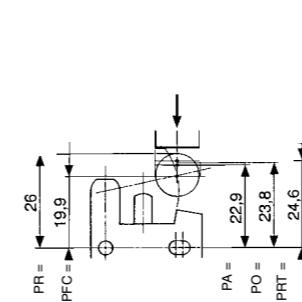

**Horizontal actuating 30° cam (other angles of attack are also possible, 45° even 90°).**

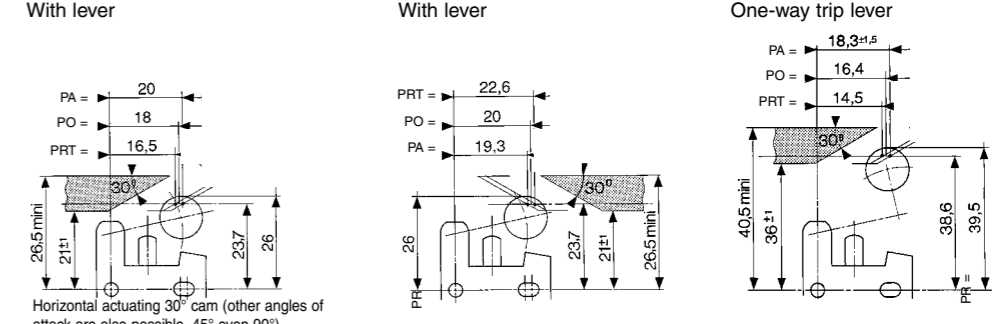

**81 921 806**

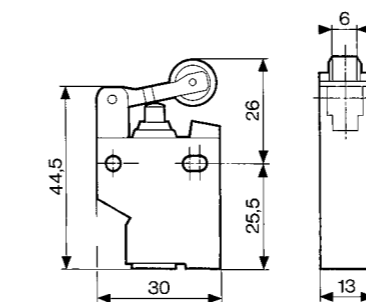

**81 921 714**

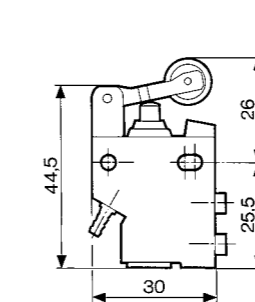

**81 921 717 - 81 921 719**

**81 921 901 - 81 921 902**

**81 921 911 - 81 921 912**

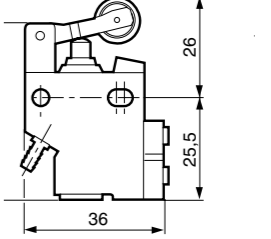

**Material: body zamak**  
**Other configuration on demand**

## "Compact" series position detectors

- > 100 % pneumatic
- > All metal

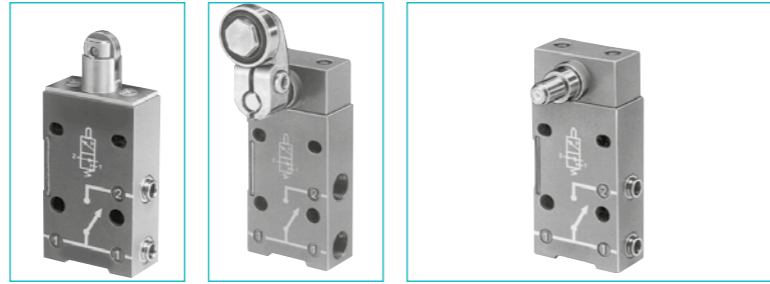

Part numbers	Direct acting 81 922 401	Rotary actuator 81 922 205	Rotary actuator 81 922 010	Rotary actuator 81 922 210
Features	Roller plunger with unthreaded barrel	Right-hand rotary head with roller lever (CNOMO)	Programmable rotary head without lever	Programmable rotary head without lever
Version				

### Symbol

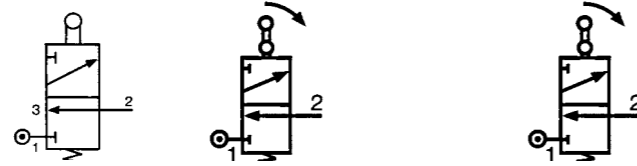

### Characteristics

Connection	BSP	—	1/8	—	1/8
push-in for semi-rigid tubing (NFE 49100)	mm	Ø 4	—	Ø 4	—
Operating pressure	bar	0.1 → 8	0.1 → 8	0.1 → 8	0.1 → 8
Bore diameter	mm	3	3	3	3
Flow at 6 bars	Nm³/h	200	200	200	200
Activation force at 6 bars	daN	2.5	2.5	2.5	2.5
Circuit function: NC		•	•	•	•
Mechanical life	operations	> 10 <sup>7</sup>	> 10 <sup>7</sup>	> 10 <sup>7</sup>	> 10 <sup>7</sup>
Silenced or connectable (1/8) exhaust		•	•	•	•
Operating temperature	°C	-5 → +50	-5 → +50	-5 → +50	-5 → +50
Weight	g	150	193	175	175

### Accessories

Accessories	Material	81 922 401	81 922 205	81 922 010	81 922 210
Lever with roller	plastic	79 452 103	•	•	•
Lever with adjustable roller	bearing	79 452 104	•	•	•
Adjustable steel rod lever	plastic	79 452 123	•	•	•
	bearing	79 452 124	•	•	•
		79 452 133	•	•	•

### Principle of operation

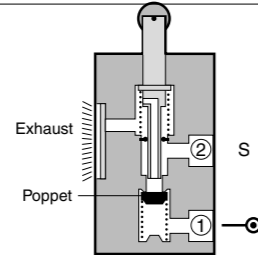

### Vertical attack

Detectors with roller plunger with unthreaded barrel.

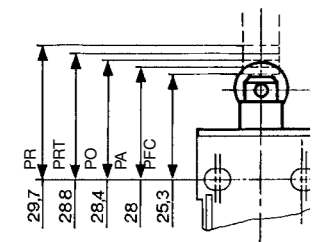

- Actuation positions :
- PA : Operating position (max output kV)
  - PFC : End of travel position
  - PO : Mid-position closed (no exhaust, no outlet)
  - PRT : Release position (max exhaust kV)
  - PR : Rest position

The detectors 81 922 010 and 81 922 210 can operate to both left and right.

**Material: body zamak**

**Other configuration on demand**

### Horizontal attack

Detectors with roller plunger with unthreaded barrel.

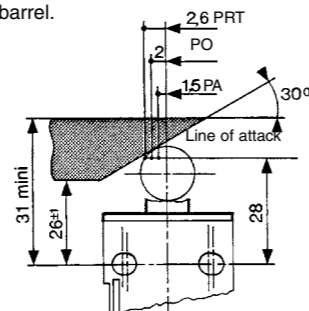

### Rotary actuator

Detectors with levers  
81 922 - 81 922 0 - 81 922 2

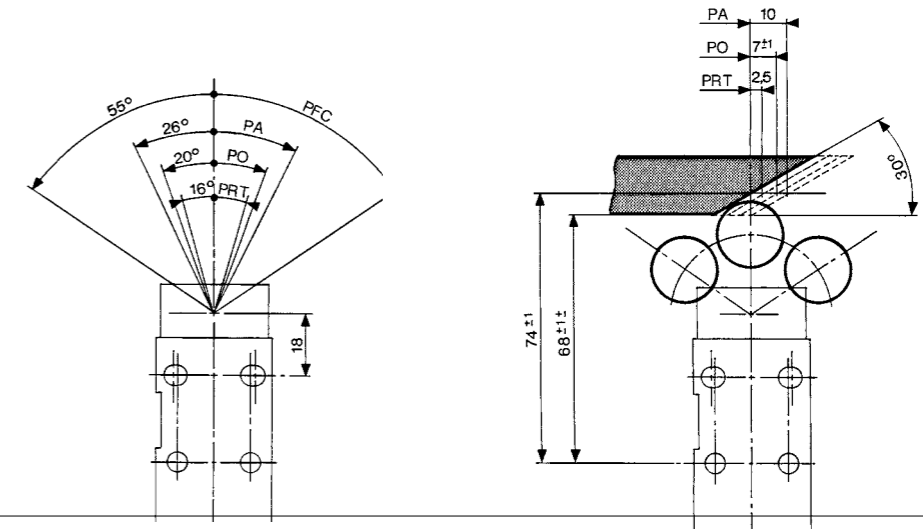

### Dimensions

81 922 401

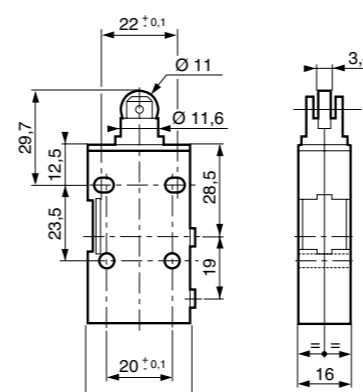

81 922 205 - 81 922 0 - 81 922 2  
79 452 103 - 79 452 104

79 452 123 - 79 452 124

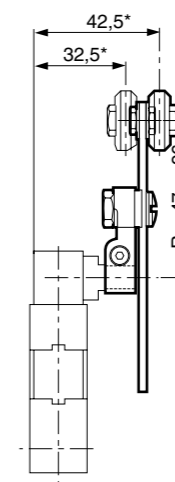

79 452 133

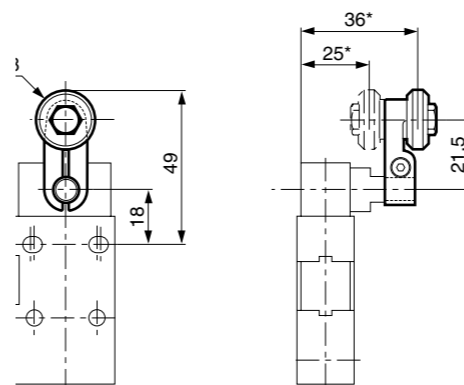
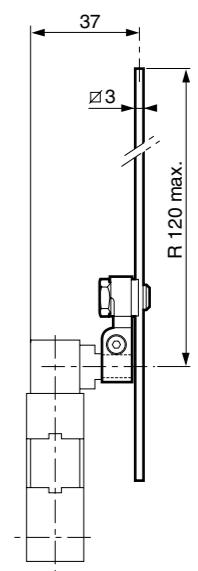

## "Adjustable stop" series position detectors

- > 100 % pneumatic
- > All metal

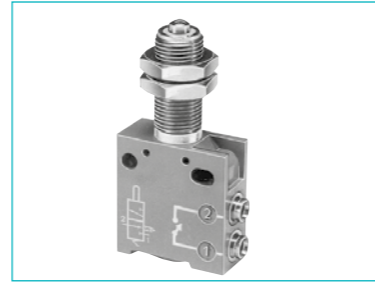
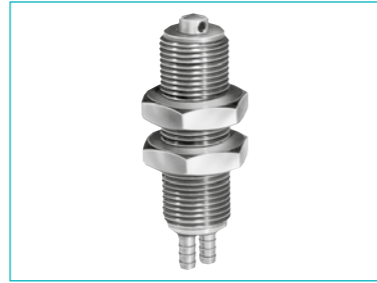

### Part numbers

81 923 001	81 921 505
Barb for tube 2.7 x 4	Push-in connector for tube Ø 4

Push-in connection for semi-rigid tubing (NFE 49100)

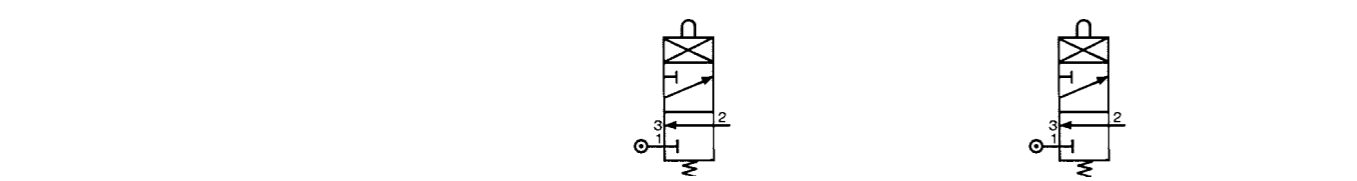

Characteristics		81 923 001	81 921 505
Operating pressure	bar	0,1 → 8	0,1 → 8
Orifice diameter	mm	2	2,7
Flow at 6 bars	NI/min	130	200
Actuation force at 6 bars	N	16	21
Circuit function: NC		•	•
Max. load: without shock	daN	1000	1000
Will stop a 63 mm Ø cylinder : 6 bar supply		•	•
Operating temperature	°C	-5 → +50	-5 → +50
Mechanical life	operations	≥10 <sup>7</sup>	≥10 <sup>7</sup>
Weight	g	27	90
Actuation positions			
PA : Operating position (max output kV)	mm	0,4	0,7
PFC : End of travel position	mm	0	0
PO : Mid-point closed (no exhaust, no outlet)	mm	0,9	1
PRT : Release position (max. exhaust kV)	mm	1,5	1,5
PR : Rest position	mm	3	3

### Principle of operation

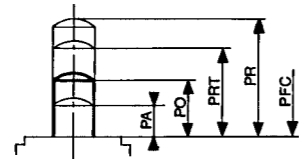
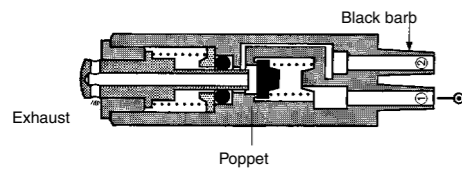

Versions	PO	PA	PFC	PRT	PR
With barb	0.9	0.4	0	1.5	3
Ø 4	1	0.7	0	1.5	3

Values in mm

**Actuation positions :**  
 PA : Operating position (max output kV)  
 PFC : End of travel position  
 PO : Mid-position closed (no exhaust, no outlet)  
 PRT : Release position (max exhaust kV)  
 PR : Rest position

### Dimensions

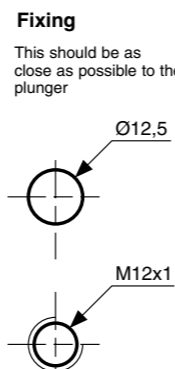
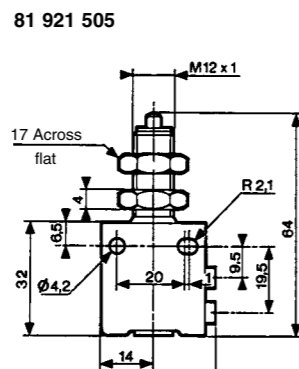
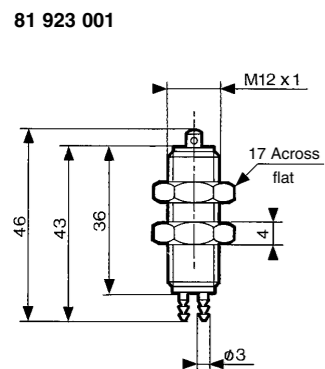

Material: body zamak

## Position detectors use with relay

- > 100 % pneumatic
- > All metal
- > Low force operation <N 1
- > Very low force Version 30 mN

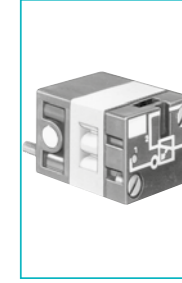
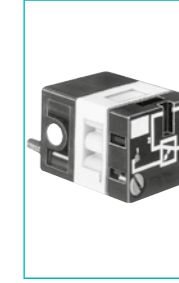
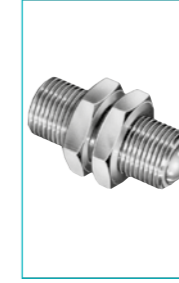

### References

Version	81 512 201	81 512 401	81 502 435	81 505 435
Symbol	with ball	with wire	Positive	Negative

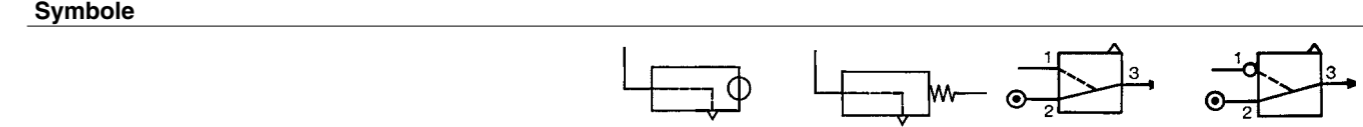

### Characteristics

	mm	Ø 4	Ø 4		
Push-in connection for semi-rigid tubing (NFE 49100)					
Life at 6 bars	operations	10 <sup>7</sup>	10 <sup>7</sup>		
Actuation force at 6 bars	N	0,8	0,025		
Fluid used: that delivered by the leak sensor relay..		•	•		
Operating temperature	°C	-5 → +50	-5 → +50	-5 → +50	-5 → +50
Weight	g	24,5	23,5	35	35
Operating pressure					
Sensor consumption for relay supply at 6 bar	bar			2 → 8	2 → 8
The distance between relay and sensor must be less than 15 m for a tube Ø 2.7 x 4 mm					
Connection - sub-base see pages 54/55				•	•
Mechanical life	operations			≥10 <sup>7</sup>	≥10 <sup>7</sup>

### Connection

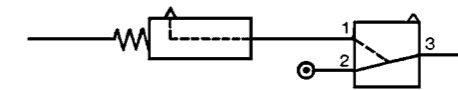

### Principle of operation

Supplied at industrial pressure, the relay produces a permanent bleed at its input port. A sensor shutting off this bleed causes the relay to switch.

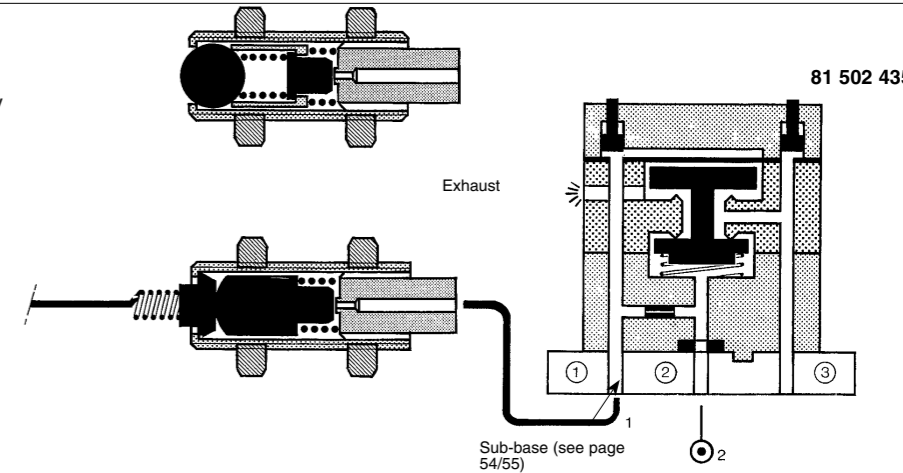

### Dimensions

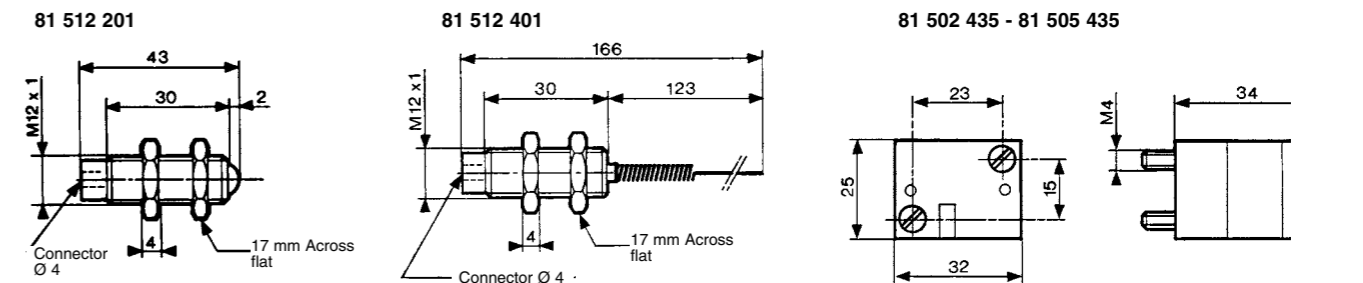

Material: brass

## Position detectors

- > 100 % pneumatic
- > All metal
- > Gap, proximity, paddle

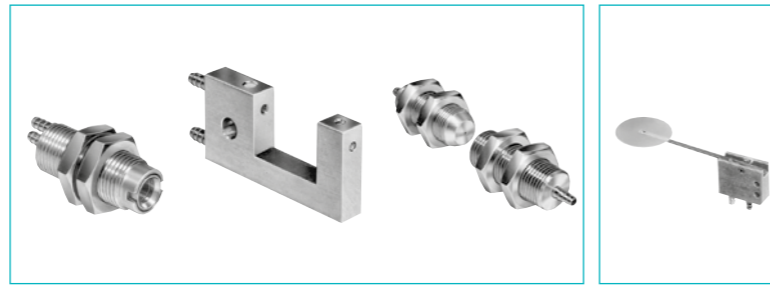

Part numbers	81 371 401	81 372 201	81 372 401	81 372 901
Detector	de proximité	gap	gap	with palette
Symbol				

### Characteristics

	mm	6 → 10	18	100	—
Detection distance	mm	6 → 10	18	100	—
18 mm gap sensor		—	—	—	—
Supply pressure	bar	0.5 → 2.5	0.5 → 2.5	0.5 → 2.5	—
Minimum output pressure	mbar	1	5	5	—
Unlimited life (static component)		●	●	●	—
Operating temperature	°C	-20 → +70	-20 → +70	-20 → +70	—
Consumption at supply pressure of:	NI/h	800	70	100	—
0.5 b	NI/h	2500	2200	700	—
2.5 b					
Barb connection for semi-rigid tubing (NFE 49100)	mm	Ø 2.7 x 4	Ø 2.7 x 4	Ø 2.7 x 4	Ø 2.7 x 4
Operating pressure	nozzle sensor	—	—	—	2 → 8
sensor d. detection 200 mm	bar	—	—	—	2 → 8
sensor d. detection 100 mm	bar	—	—	—	1 → 4
Flow nozzle at 2 bars	NI/h	—	—	—	320
sensor at 2 bars	NI/h	—	—	—	320
at 2 bars	N	—	—	—	0.03
at 6 bars	N	—	—	—	0.09
Sensor consumption for relay supply at 6 bars	NI/min	—	—	—	5
Weight	g	36	9	63	14

### Principle of operation

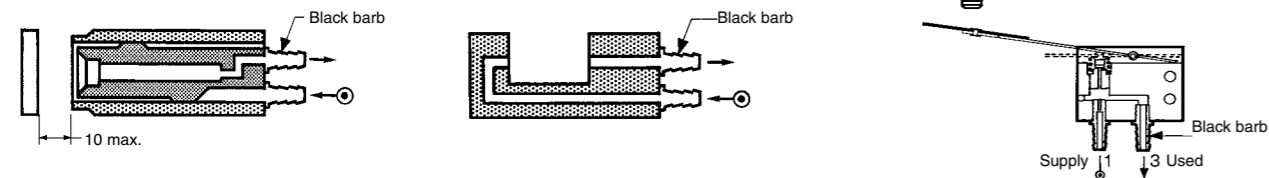

### Connection

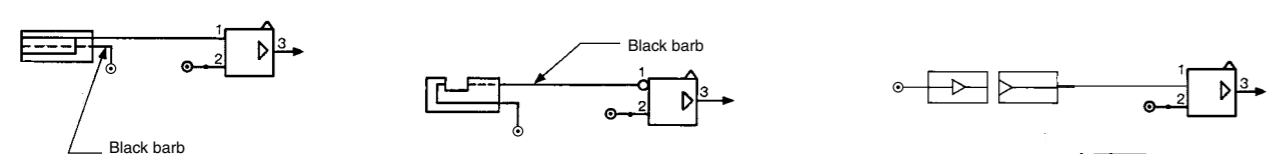

### Encombremments

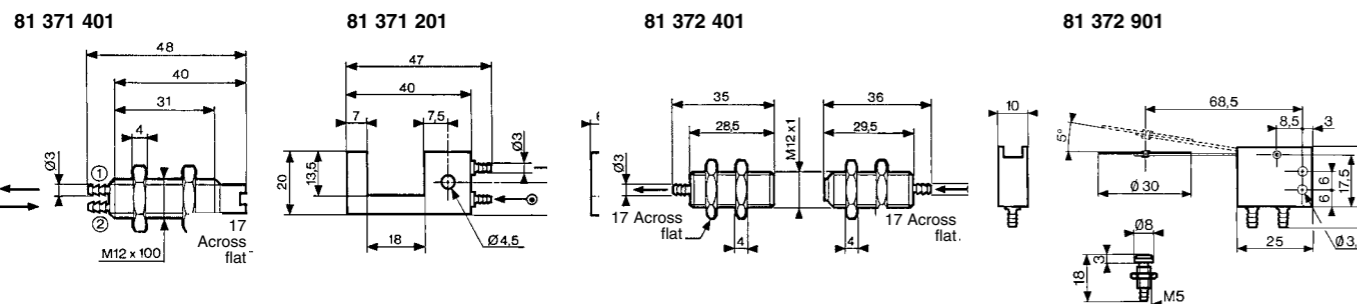

## Amplifiers for mounting on installation plan

### > Gap sensor

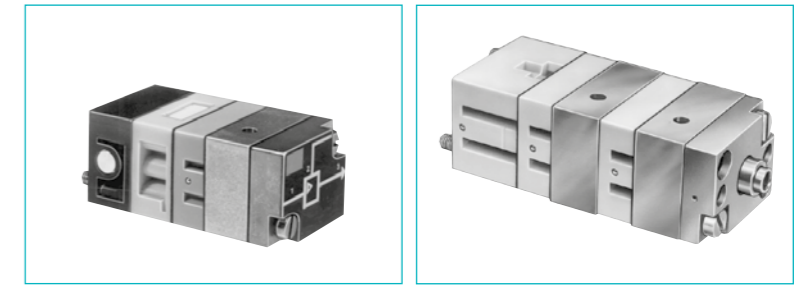

Also available in **ATEX** version for use in potentially explosive atmospheres in accordance with 94/9/EC Directive

Part numbers	81 502 230	81 505 230	81 502 320	81 505 320
Simple amplifiers (for 81 372 201/401)	—	—	—	—
Sensitive amplifiers (for 81 371 401)	—	—	—	—
Version	positive	negative	positive	negative
Symbol				

### Characteristics

	mb	10 → 20	10 → 20	1 → 4	1 → 4
Pressure to make	mb	10 → 20	10 → 20	1 → 4	1 → 4
Operating pressure (non-lubricated air)	bar	2 → 8	2 → 8	2 → 6	2 → 6
Orifice diameter	mm	2.5	2.5	2.5	2.5
Average consumption at 4 bars	NI/min	5	5	5	5
Permissible overload for 1 hour	mb	800	800	800	800
Operating temperature	°C	-5 → +50	-5 → +50	-5 → +50	-5 → +50
Mechanical life	operations	3 x 10 <sup>6</sup>	3 x 10 <sup>6</sup>	3 x 10 <sup>6</sup>	3 x 10 <sup>6</sup>
Weight	g	150	150	185	185

### Connections

Used for gaps up to 25 mm.  
The supply to the sensor should be made via a pressure regulator or one-way flow restrictor (see page 52)  
Connection - sub-base

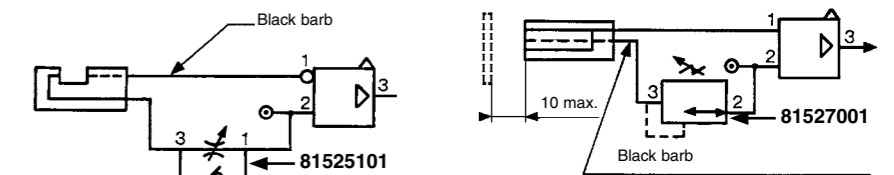

### Principle of operation

#### Simple amplifiers

An output at normal industrial pressure is delivered on a low pressure input.  
NB: Hysteresis is 20% of the pilot pressure.

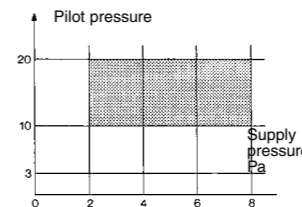

#### 81 502 230

#### Positive output

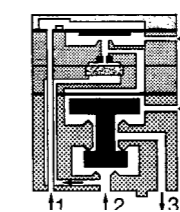

#### 81 505 230

#### Negative output

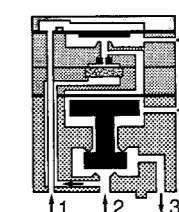

1- pilot  
2- supply  
3- output

#### Sensitive amplifiers

An output at normal industrial pressure is delivered on a very low pressure input.

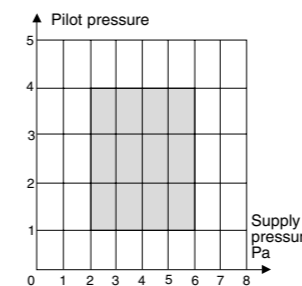

#### 81 502 320

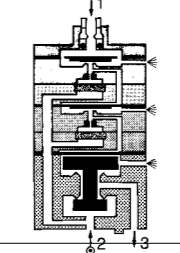

#### 81 505 320

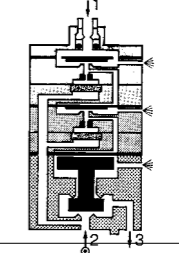

Note: The specifications are given for a supply pressure of 6 bars, and for detection at the mid-point of the gap.

### Dimensions

#### 81 502 238 - 81 505 231

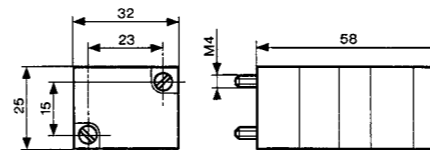

#### 81 502 322 - 81 505 321

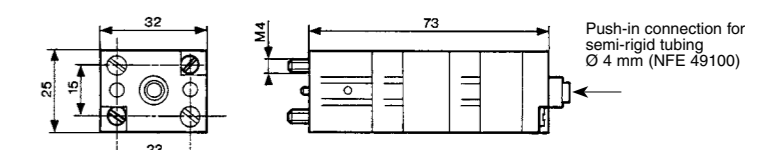

### Other information

With gap sensors, use an amplifier with negative output if you require a signal on interruption of the jet.

ATEX version products are available in the following catalogues: **Pneumatic products for explosive atmospheres** or on our website [www.crouzet.com](http://www.crouzet.com)

# Amplifier with intégral régulateur, positive output

- › Setting Flow
- › Fixing rail 35mm wide



### Part numbers

Amplifiers with integral regulator	<b>81 510 001</b>
Version	Positive output

### Symbol

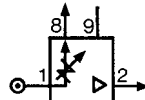

### Characteristics

Pressure to make	mb	0.5 → 1.5	—	—	
Reduced pressure supplied at port 8	bar	0.5 → 2.5	—	—	
Flow through port 8	Nm³/h	0.1 → 2.5	—	—	
Consumption of amplifier only	NI/h	100 → 200	—	—	
Permissible overload for 1 hour	mb	300	—	—	
Operating temperature	°C	-5 → +50	-5 → +50	-5 → +50	
Mechanical life	operations	3 x 10 <sup>6</sup>	3 x 10 <sup>6</sup>	3 x 10 <sup>6</sup>	
Weight	g	380	—	—	
Detectors (see page 28)		Proximity	Gap	Proximity	
		Ø 12	Ø 18	Ø 12	
		81 371 401	81 372 201	81 372 401	
Nominal range	mm	8	18	100	
Min. total consumption for detection (0.5 b regulated pressure)	NI/h	880	140	—	
Max. total consumption for short response time (2.5 b regulated pressure)	NI/h	2750	400	920	
Min. detectable					
dimensions	nominal sensing distance	mm	Ø 3	Ø 2 - Ø 1.5	Ø 7 - Ø 6.5
Max. frequency of use	2	mm	2	—	—
Force exerted by the jet on the parts to be detected	Hz	5	5	5	—
	N	0.02 → 0.7	0.01 → 0.03	0.1	—

### Connection

To use with detectors page 32

### Principle of operation

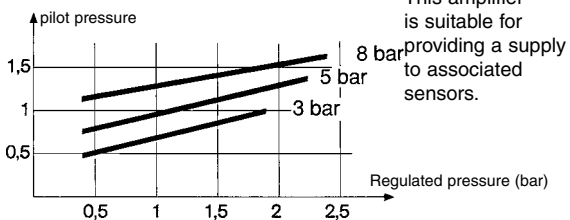

### Dimensions

Push-in connection for semi-rigid tubing Ø 4 mm (NFE 49100)

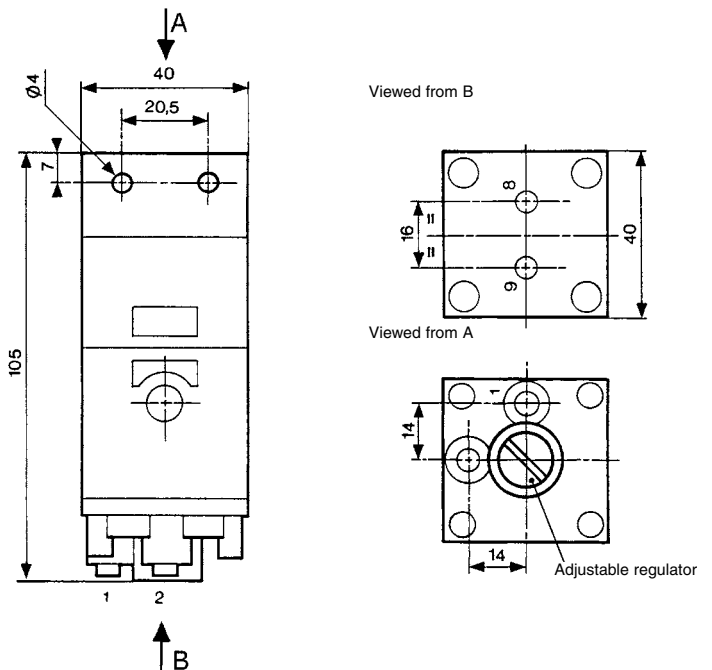



Компания «Life Electronics» занимается поставками электронных компонентов импортного и отечественного производства от производителей и со складов крупных дистрибьюторов Европы, Америки и Азии.

С конца 2013 года компания активно расширяет линейку поставок компонентов по направлению коаксиальный кабель, кварцевые генераторы и конденсаторы (керамические, пленочные, электролитические), за счёт заключения дистрибьюторских договоров

Мы предлагаем:

- Конкурентоспособные цены и скидки постоянным клиентам.
- Специальные условия для постоянных клиентов.
- Подбор аналогов.
- Поставку компонентов в любых объемах, удовлетворяющих вашим потребностям.
- Приемлемые сроки поставки, возможна ускоренная поставка.
- Доставку товара в любую точку России и стран СНГ.
- Комплексную поставку.
- Работу по проектам и поставку образцов.
- Формирование склада под заказчика.
- Сертификаты соответствия на поставляемую продукцию (по желанию клиента).
- Тестирование поставляемой продукции.
- Поставку компонентов, требующих военную и космическую приемку.
- Входной контроль качества.
- Наличие сертификата ISO.

В составе нашей компании организован Конструкторский отдел, призванный помогать разработчикам, и инженерам.

Конструкторский отдел помогает осуществить:

- Регистрацию проекта у производителя компонентов.
- Техническую поддержку проекта.
- Защиту от снятия компонента с производства.
- Оценку стоимости проекта по компонентам.
- Изготовление тестовой платы монтаж и пусконаладочные работы.



Тел: +7 (812) 336 43 04 (многоканальный)

Email: [org@lifeelectronics.ru](mailto:org@lifeelectronics.ru)