

## Adafruit Powerboost 1000 Basic

Created by lady ada

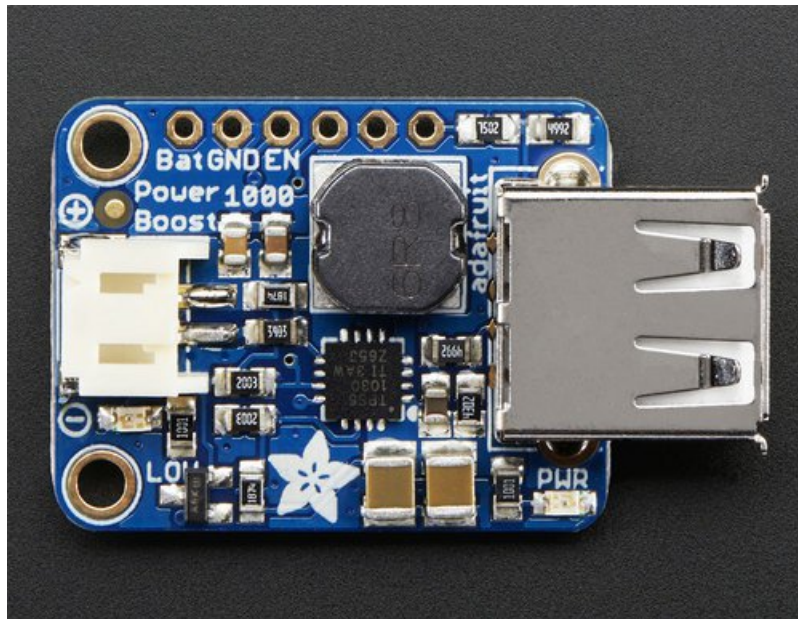

Last updated on 2018-08-22 03:42:57 PM UTC

## Guide Contents

Guide Contents	2
Overview	3
Pinouts	7
Power Pins	8
Control Pins	8
( <a href="https://adafru.it/dLZ">https://adafru.it/dLZ</a> )LEDs	8
Battery and USB connection	8
Downloads	10
Datasheets & Files	10
Schematics	10
PCB Print	10

## Overview

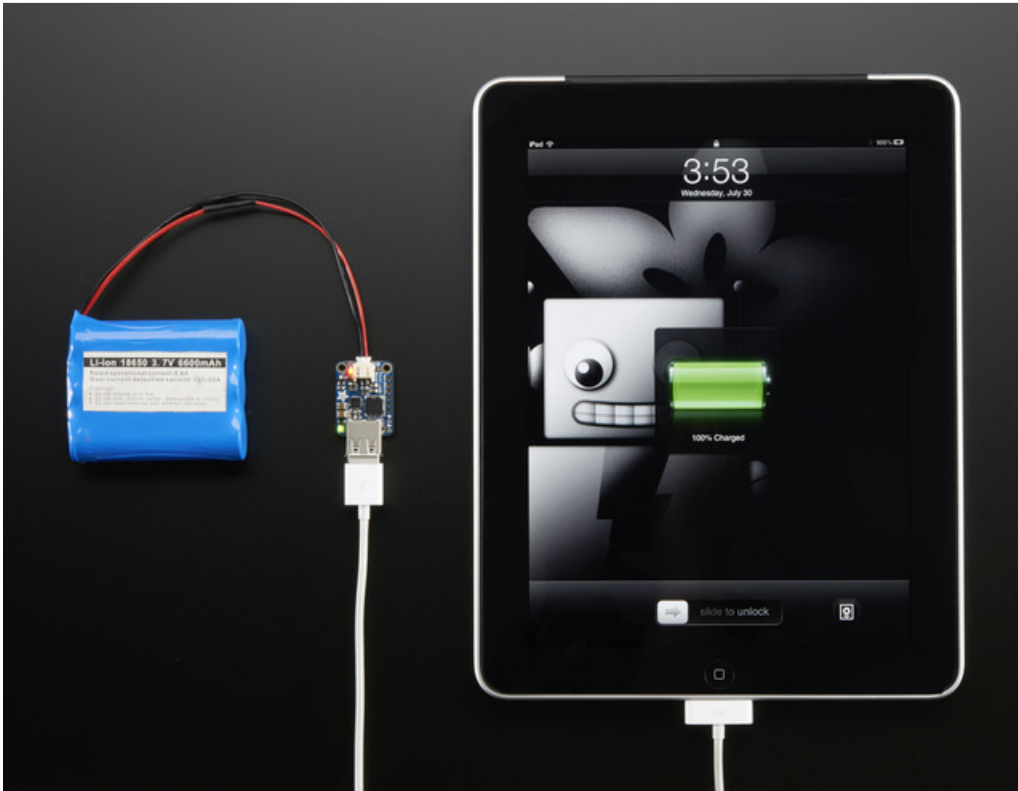

PowerBoost is the perfect power supply for your power-hungry portable project! This little DC/DC boost converter module can run from 1.8V batteries or higher, and convert that voltage to 5.2V DC for running your 5V projects. With a beefy 4A DC/DC converter, it can give you 1A+ from as low as 2V.

Like our popular [5V 1A USB wall adapter \(https://adafruit.it/duP\)](https://adafruit.it/duP), we tweaked the output to be 5.2V instead of a straight-up 5.0V so that there's a little bit of 'headroom' long cables, high draw, the addition of a diode on the output if you wish, etc. The 5.2V is safe for all 5V-powered electronics like Arduino, Raspberry Pi, or Beagle Bone while preventing icky brown-outs during high current draw because of USB cable resistance.

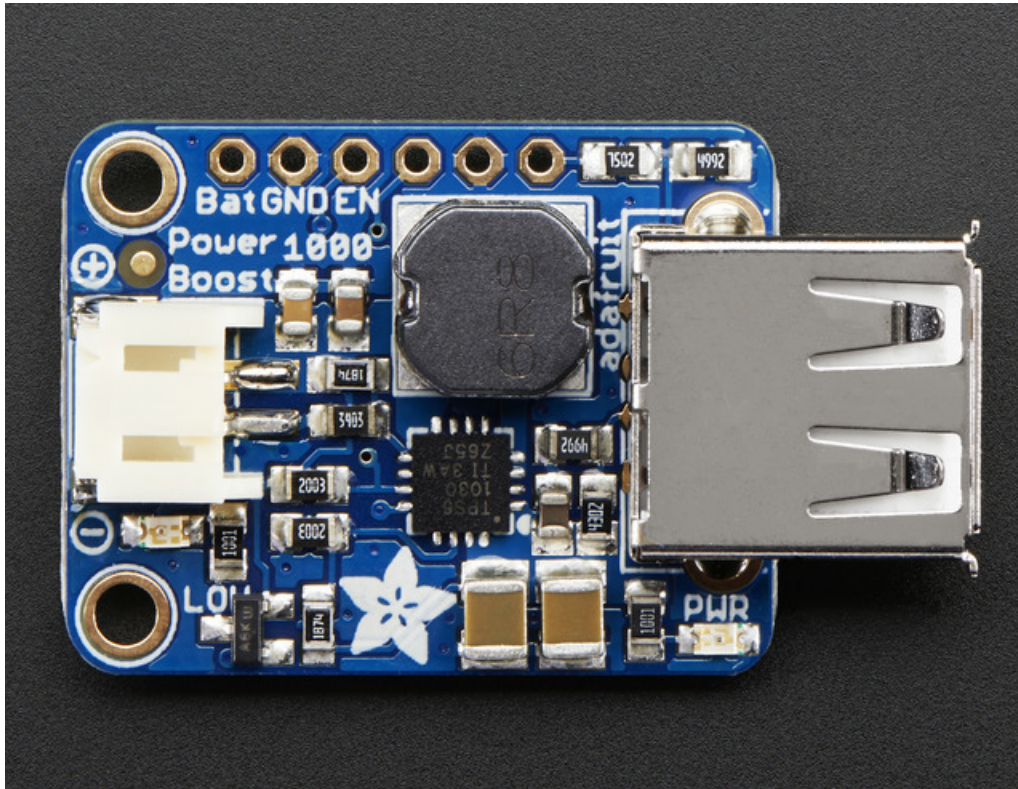

The PowerBoost 1000 has at the heart a [TPS61030 boost converter from TI](https://adafruit.it/dLY) (<https://adafruit.it/dLY>). This boost converter chip has some really nice extras such as low battery detection, 4A internal switch, synchronous conversion, excellent efficiency, and 700KHz high-frequency operation. Check out these specs!

- Synchronous operation means you can disconnect the output completely by connecting the **EN**able pin to ground. This will completely turn off the output
- 4A internal switch means you can get **1000mA+** from as low as **1.8V**, **1500mA+** from **2 NiMH** or Alkaline batteries, and at least **2000mA** from a **3.7V LiPoly/Lilon battery** or 3 NiMH/Alkalines. Just make sure your batteries can actually supply 3-4A, OK?
- **Low battery indicator LED** lights up red when the voltage dips below 3.2V, optimized for the most common usage of LiPo/Lilon battery usage
- On-board 1000mA charge-rate 'Apple/iOS' data resistors. Solder in the included USB connector and you can plug in any iPhone or iPod for a speedy 1000mA charge rate. Works with iPads, both mini and 'classic' type.
- Full breakout for battery in, control pins and power out
- **90%+ operating efficiency** in most cases (see datasheet for efficiency graphs), and low quiescent current: 5mA when enabled and power LED is on, 20uA when disabled (power and low batt LED are off)

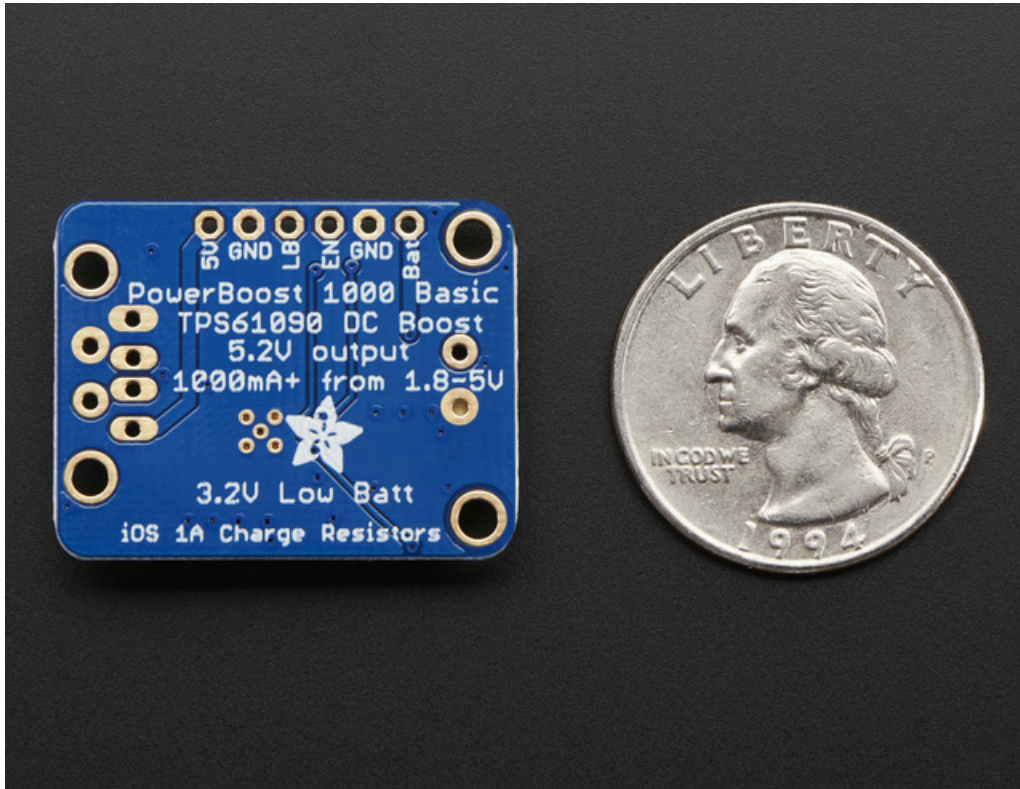

Great for powering your robot, Arduino project, single-board-computer such as Raspberry Pi or BeagleBone! Each order comes with one fully assembled and tested PCB, a loose 2-PH JST jack, a 2-pin Terminal block and a loose USB A jack.

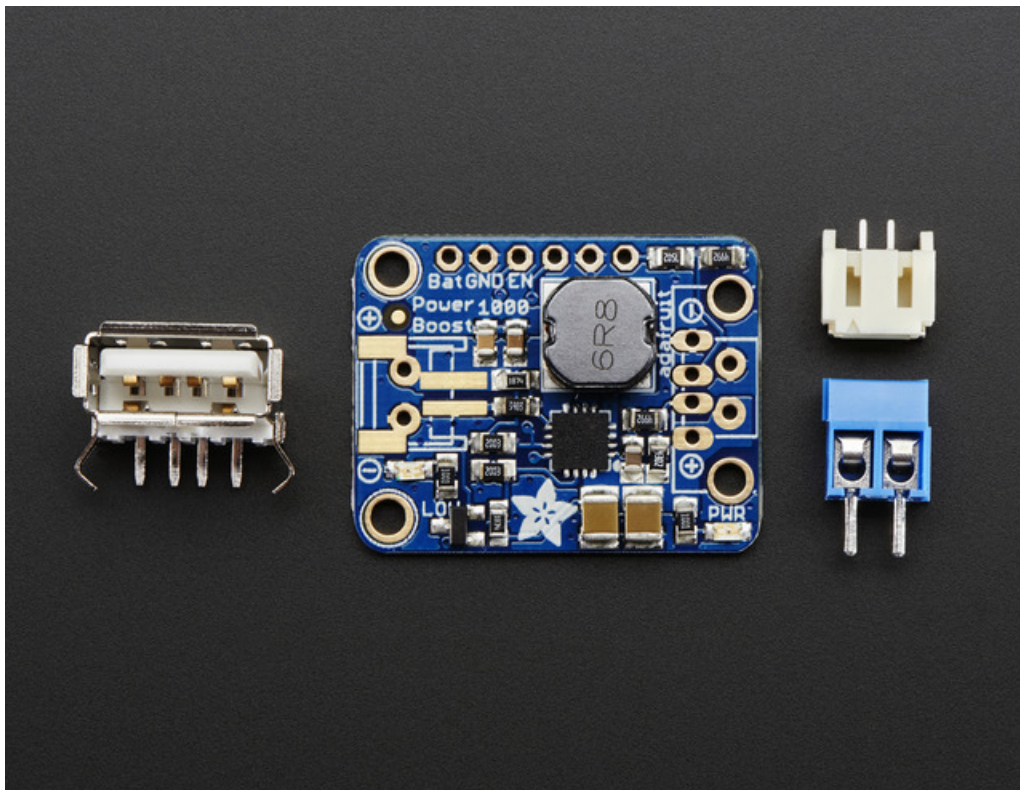

If you are powering your project from USB, solder the USB A jack in (a 3-minute soldering task). Then choose either JST for input (JST is often used for our Lilon batteries, but the connector is only rated for 2A) *or* a terminal block.

If you would like to use another terminal block for output, pick up a 3.5mm 2pin block here(<https://adafru.it/duR>) and solder to the output spot where the USB jack would go. Or don't solder any connectors in for a more compact power pack and go with 22AWG wires soldered directly in.

## Pinouts

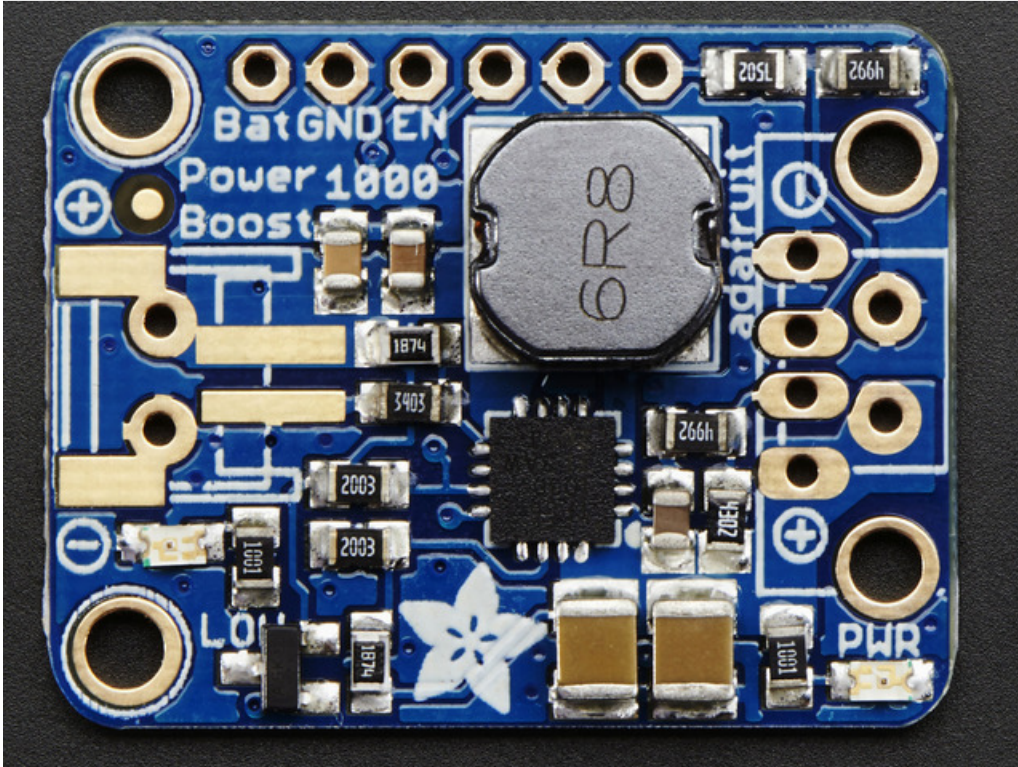

For many people, the PowerBoost can be used with just the power input and power outputs. However, we have a couple handy breakouts so lets get started!

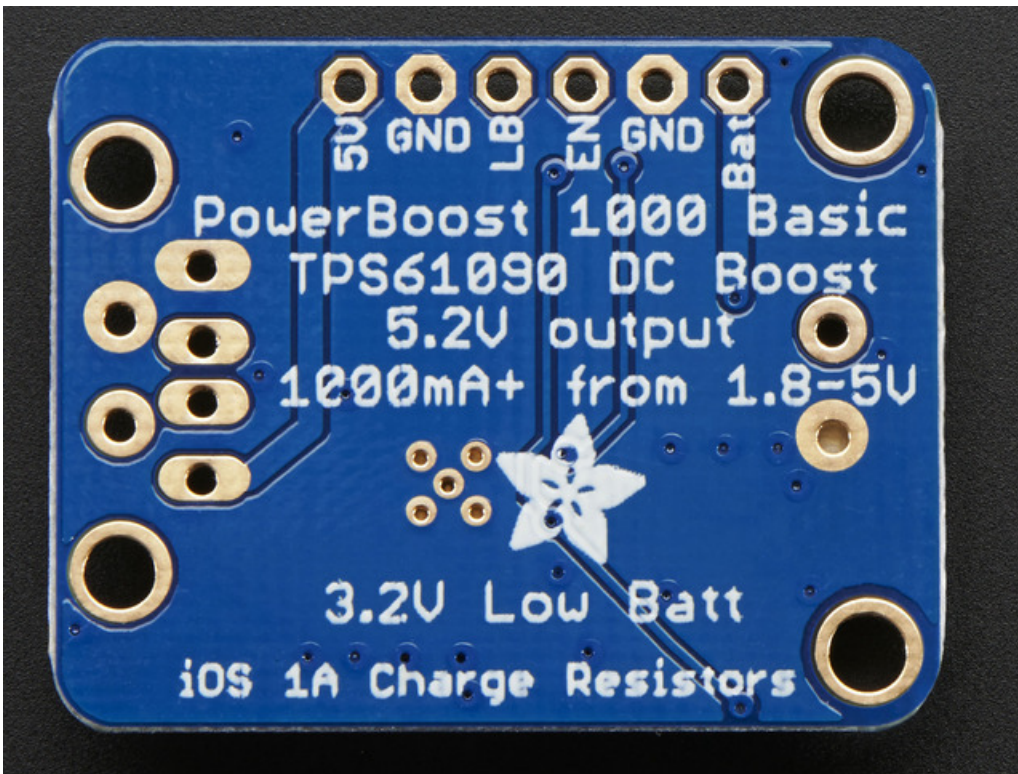

## Power Pins

---

There's two power 'ports' - an input (called **BAT**) and an output (called **5V**)

- **BAT** - this is the battery input, it can range from 1.8V to 5V. Higher voltages will let you draw more current and in general, are more efficient. Try to keep the wires going to this pin nice and short - 1.5" or less is best!
- **GND** - this is the power ground. This boost converter is not 'isolated' - the ground input is the same as the ground output
- **5V** - this is the boosted output. When the board is running, the voltage will be 5.2V approximately. It may dip down to 5V as the current draw starts to go up (over 1000mA). When the board is disabled, this output is 'floating' but you should still try not to apply a voltage to it while the board is disabled. There's a green LED connected to this pin which will let you know when there's power output

Using a bench-top supply or long wires can add too much inductance to the input of the boost converter and destroy it! We really do recommend using Lipoly batteries with short wires

## Control Pins

---

There's two 'control' pins.

- **EN** - this is the 'enable' pin. By default it is pulled 'high' to **VBAT**. To turn off the booster, connect this pin to ground. The switch can be as small as you like, it is just a signal. Contrast this to an inline power switch which would have to be able to handle up to 4A of current! When the chip is disabled the output is completely disconnected from the input.
- **LBO** - not a leveraged buy out! this is the **Low Battery Output**. By default it is pulled high to **BAT** but when the charger detects a low voltage (under 3.2V) the pin will drop down to 0V. You can use this to signal when its time to shut down or alert the user that the battery is low. There is also a red LED connected to this pin.

### <https://adafru.it/dLZ>LEDs

There are two onboard LEDs. The Green LED sits next to the USB connector socket, and indicates the 5V output power state. The Red LED is next to the battery JST port and indicates when the battery voltage is below 3.2VDC

## Battery and USB connection

---

You can connect a battery to the breakout strip or to the input end. **We do not solder on a JST connector because JST 2-PH are rated for 2A** and the boost converter can suck up to 4A thru the contacts! If you're pretty sure that you won't be sourcing more than 2A, say if you're going to have 1A output and 3.7V LiPoly/Lilon input, you can go ahead and use a JST connector. All of Adafruit batteries come with JST cables that will plug in nicely. **Watch the polarity of the cable!** the + and - markings next to the JST will let you know which way is which.

If you aren't using a Lilon or if you are going to be drawing more than 2A from the input, then we suggest going with the 3.5mm terminal block, solder that where the JST would go.

On the output side, the USB connector can be soldered on to create a portable 'USB power pack'. The two data lines on USB have resistor dividers that match Apple charger values so that you can plug any iOS device in to charge. 99% of other phones, devices and tables are totally cool with these resistors as well. You can always short the D+ and D- lines if you happen to have a phone that wants shorted data lines.

If you don't want a USB connector attached, there are two holes that are designed for a 3.5mm spaced terminal block





## Downloads

## Datasheets & Files

- [TPS61030 datasheet](https://adafru.it/dM0) (<https://adafru.it/dM0>) (the DC/DC boost control chip used)
- [EagleCAD PCB files on GitHub](https://adafru.it/pD1) (<https://adafru.it/pD1>)
- [Fritzing object in Adafruit Fritzing library](https://adafru.it/aP3) (<https://adafru.it/aP3>)

## Schematics

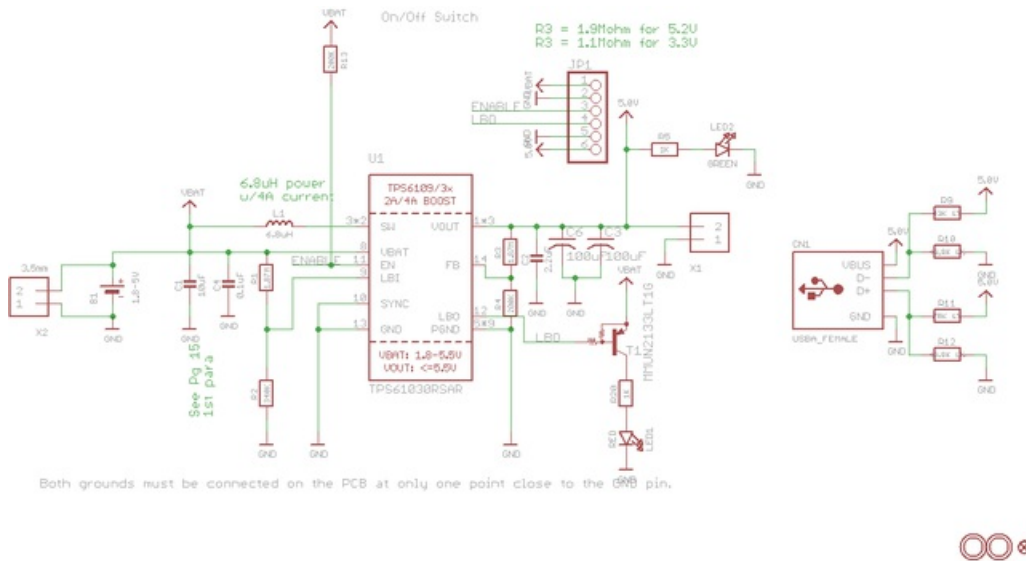

## PCB Print

Dimensions in Inches

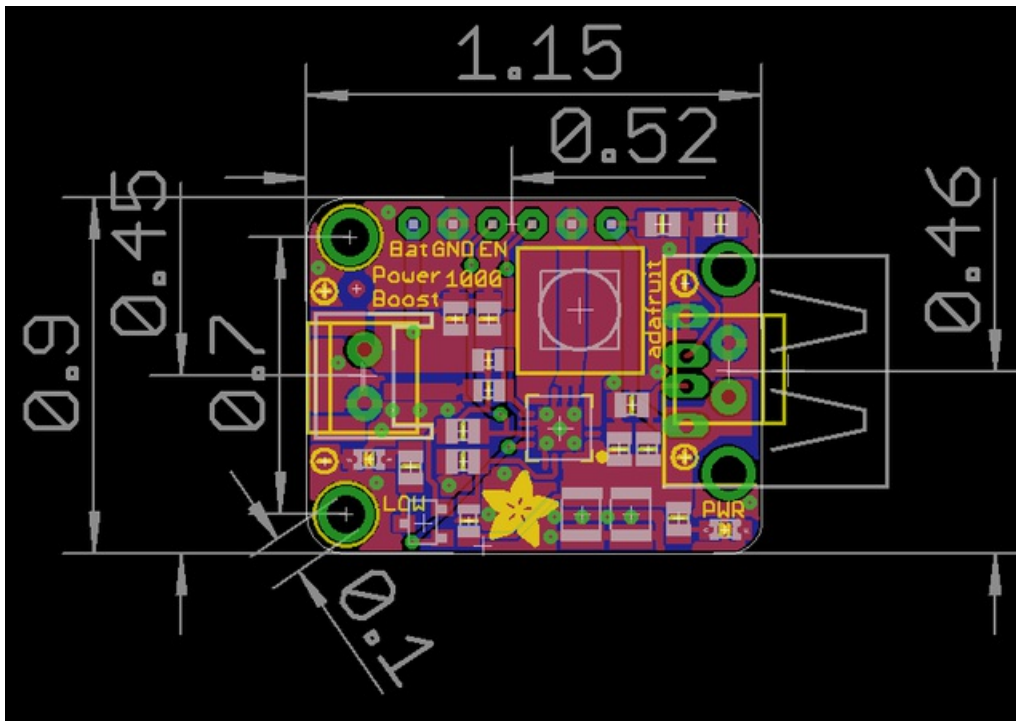



Компания «Life Electronics» занимается поставками электронных компонентов импортного и отечественного производства от производителей и со складов крупных дистрибьюторов Европы, Америки и Азии.

С конца 2013 года компания активно расширяет линейку поставок компонентов по направлению коаксиальный кабель, кварцевые генераторы и конденсаторы (керамические, пленочные, электролитические), за счёт заключения дистрибьюторских договоров

Мы предлагаем:

- Конкурентоспособные цены и скидки постоянным клиентам.
- Специальные условия для постоянных клиентов.
- Подбор аналогов.
- Поставку компонентов в любых объемах, удовлетворяющих вашим потребностям.
- Приемлемые сроки поставки, возможна ускоренная поставка.
- Доставку товара в любую точку России и стран СНГ.
- Комплексную поставку.
- Работу по проектам и поставку образцов.
- Формирование склада под заказчика.
- Сертификаты соответствия на поставляемую продукцию (по желанию клиента).
- Тестирование поставляемой продукции.
- Поставку компонентов, требующих военную и космическую приемку.
- Входной контроль качества.
- Наличие сертификата ISO.

В составе нашей компании организован Конструкторский отдел, призванный помогать разработчикам, и инженерам.

Конструкторский отдел помогает осуществить:

- Регистрацию проекта у производителя компонентов.
- Техническую поддержку проекта.
- Защиту от снятия компонента с производства.
- Оценку стоимости проекта по компонентам.
- Изготовление тестовой платы монтаж и пусконаладочные работы.



Тел: +7 (812) 336 43 04 (многоканальный)  
Email: [org@lifeelectronics.ru](mailto:org@lifeelectronics.ru)