

RoHS **Sxx12x Series**

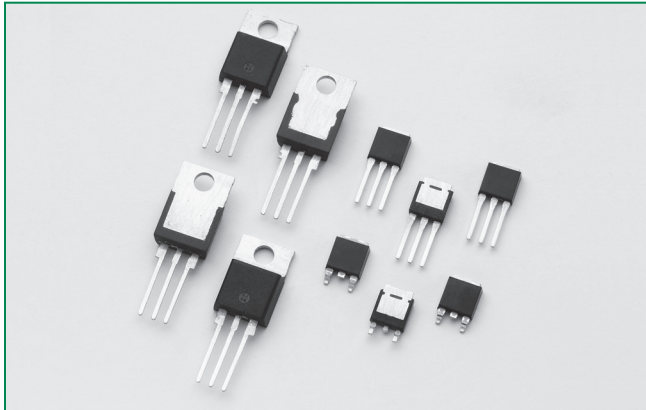

Description

Excellent unidirectional switches for phase control applications such as heating and motor speed controls. Standard phase control SCRs are triggered with few milliamperes of current at less than 1.5V potential.

Features & Benefits

- RoHS compliant
- Glass – passivated junctions
- Voltage capability up to 1000 V
- Surge capability up to 120 A

Applications

Typical applications are capacitive discharge systems for strobe lights, nailers, staplers and gas engine ignition. Also controls for power tools, home/brown goods and white goods appliances.

Main Features

| Symbol | Value | Unit |
|-------------------|-------------|------|
| $I_{T(RMS)}$ | 12 | A |
| V_{DRM}/V_{RRM} | 400 to 1000 | V |
| I_{GT} | 20 | mA |

Schematic Symbol

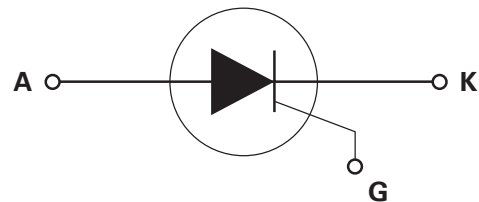

Absolute Maximum Ratings

| Symbol | Parameter | Test Conditions | | Value | Unit |
|--------------|---|--|---------------------------|------------|------------------------|
| $I_{T(RMS)}$ | RMS on-state current | Sxx12R Sxx12D Sxx12V | $T_c = 105^\circ\text{C}$ | 12 | A |
| $I_{T(AV)}$ | Average on-state current | Sxx12R Sxx12D Sxx12V | $T_c = 105^\circ\text{C}$ | 7.6 | A |
| I_{TSM} | Peak non-repetitive surge current | single half cycle; $f = 50\text{Hz}$; $T_J(\text{initial}) = 25^\circ\text{C}$ | | 100 | A |
| | | single half cycle; $f = 60\text{Hz}$; $T_J(\text{initial}) = 25^\circ\text{C}$ | | 120 | |
| I^2t | I^2t Value for fusing | $t_p = 8.3 \text{ ms}$ | | 60 | A^2s |
| di/dt | Critical rate of rise of on-state current | $f = 60\text{Hz}$; $T_J = 125^\circ\text{C}$ | | 100 | $\text{A}/\mu\text{s}$ |
| I_{GM} | Peak gate current | $T_J = 125^\circ\text{C}$ | | 2 | A |
| $P_{G(AV)}$ | Average gate power dissipation | $T_J = 125^\circ\text{C}$ | | 0.5 | W |
| T_{stg} | Storage temperature range | | | -40 to 150 | $^\circ\text{C}$ |
| T_J | Operating junction temperature range | | | -40 to 125 | |

Note: xx = voltage

Electrical Characteristics (T_J = 25°C, unless otherwise specified)

| Symbol | Test Conditions | | Value | Unit | |
|-----------------|--|-------|-------|------|------|
| I _{GT} | V _D = 12V R _L = 60 Ω | | MAX. | 20 | mA |
| V _{GT} | | | MIN. | 1 | |
| | | | | MAX. | 1.5 |
| dv/dt | V _D = V _{DRM} ; gate open; T _J = 100°C | 400V | MIN. | 350 | V/μs |
| | | 600V | | 300 | |
| | | 800V | | 250 | |
| | | 1000V | | 100 | |
| | V _D = V _{DRM} ; gate open; T _J = 125°C | 400V | | 250 | |
| | | 600V | | 225 | |
| | 800V | 200 | | | |
| V _{GD} | V _D = V _{DRM} R _L = 3.3 kΩ T _J = 125°C | | MIN. | 0.2 | V |
| I _H | I _T = 200mA (initial) | | MAX. | 40 | mA |
| t _q | I _T = 2A; t _p = 50μs; dv/dt = 5V/μs; di/dt = 30A/μs | | MAX. | 35 | μs |
| t _{gt} | I _G = 2 x I _{GT} PW = 15μs I _T = 20A | | TYP. | 2 | μs |

Static Characteristics

| Symbol | Test Conditions | | Value | Unit | | |
|-------------------------------------|---|------------------------|-------------|------|------|----|
| V _{TM} | I _T = 24A; t _p = 380 μs | | MAX. | 1.6 | V | |
| I _{DRM} / I _{RRM} | V _{DRM} = V _{RRM} | T _J = 25°C | 400 – 600V | MAX. | 10 | μA |
| | | | 800 – 1000V | | 20 | |
| | | T _J = 100°C | 400 – 800V | | 500 | |
| | | | 1000V | | 3000 | |
| | T _J = 125°C | 400 – 800V | 1000 | | | |

Thermal Resistances

| Symbol | Parameter | Value | Unit | |
|---------------------|-----------------------|--------|------|------|
| R _{θ(J-C)} | Junction to case (AC) | Sxx12R | 1.5 | °C/W |
| | | Sxx12V | 1.6 | |
| | | Sxx12D | 1.4 | |
| R _{θ(J-A)} | Junction to ambient | Sxx12R | 40 | °C/W |
| | | Sxx12V | 70 | |

Note: xx = voltage

Figure 1: Normalized DC Gate Trigger Current vs. Junction Temperature

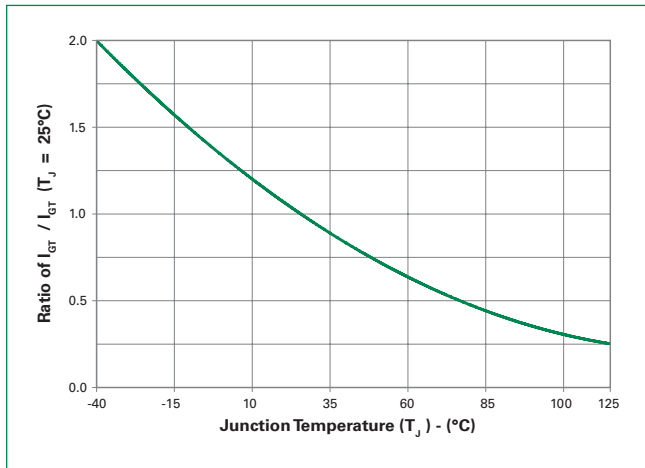

Figure 2: Normalized DC Gate Trigger Voltage vs. Junction Temperature

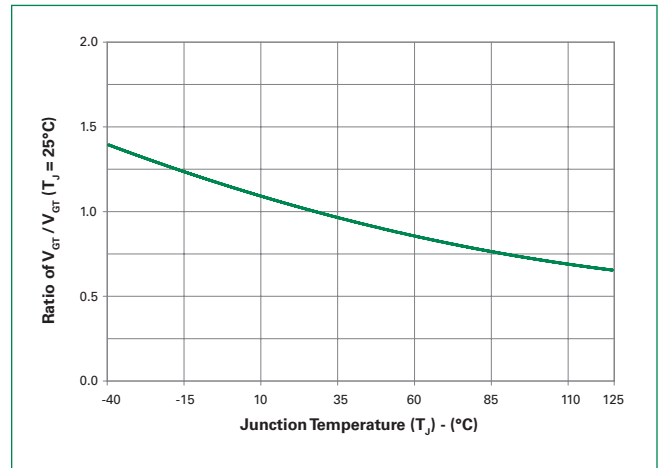

Figure 3: Normalized DC Holding Current vs. Junction Temperature

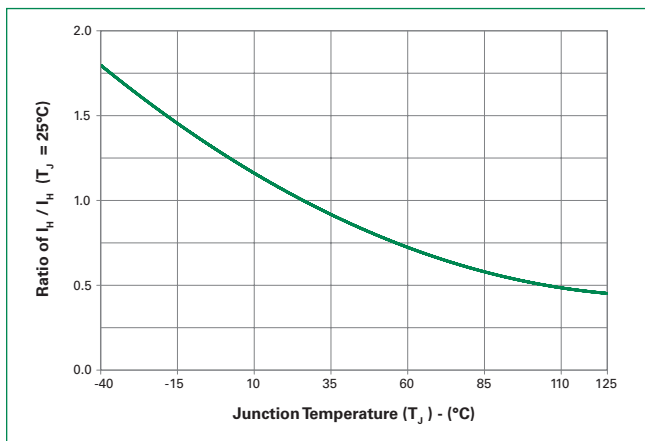

Figure 4: On-State Current vs. On-State Voltage (Typical)

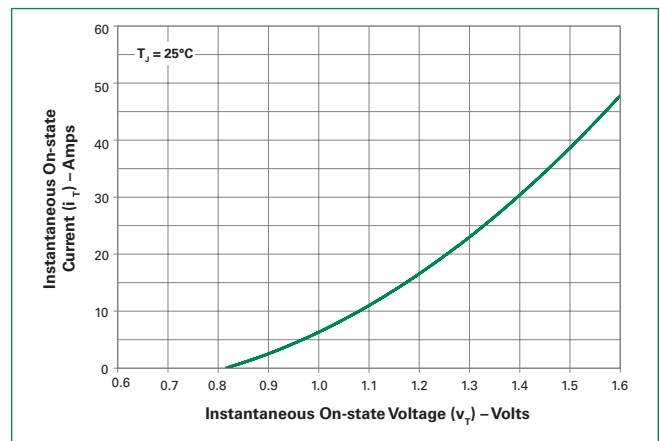

Figure 5: Power Dissipation (Typical) vs. RMS On-State Current

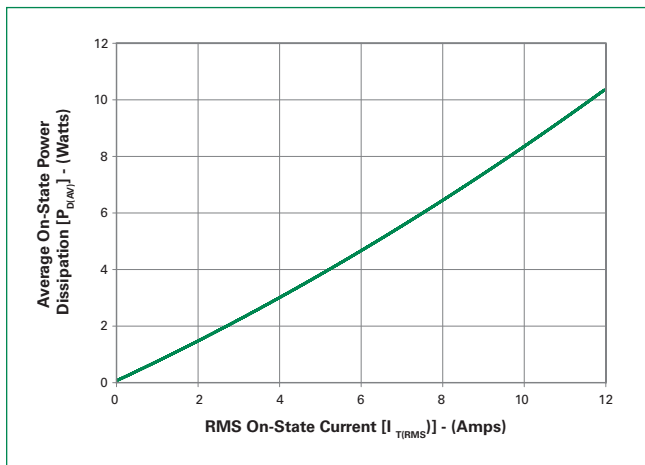

Figure 6: Maximum Allowable Case Temperature vs. RMS On-State Current

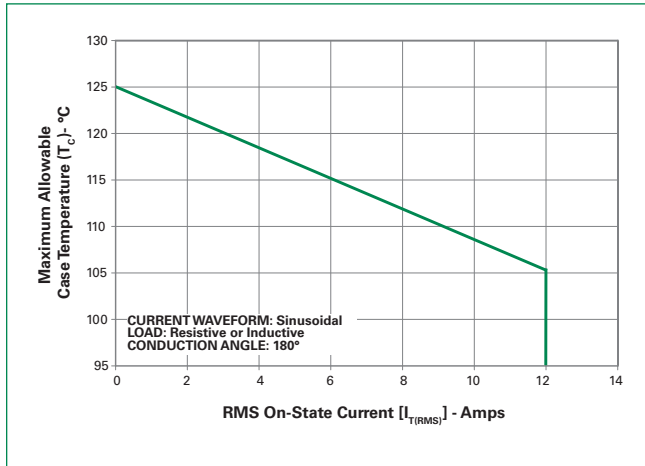

Figure 7: Maximum Allowable Case Temperature vs. Average On-State Current

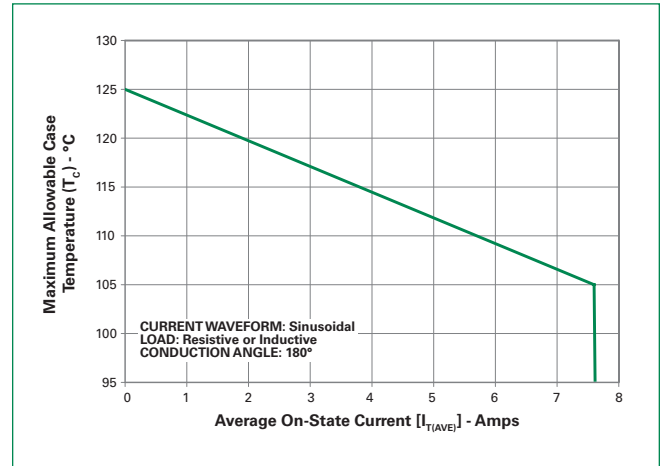

Figure 8: Maximum Allowable Ambient Temperature vs. RMS On-State Current

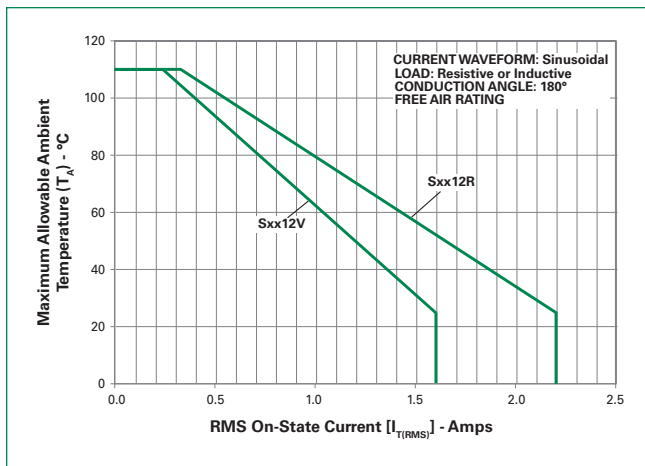
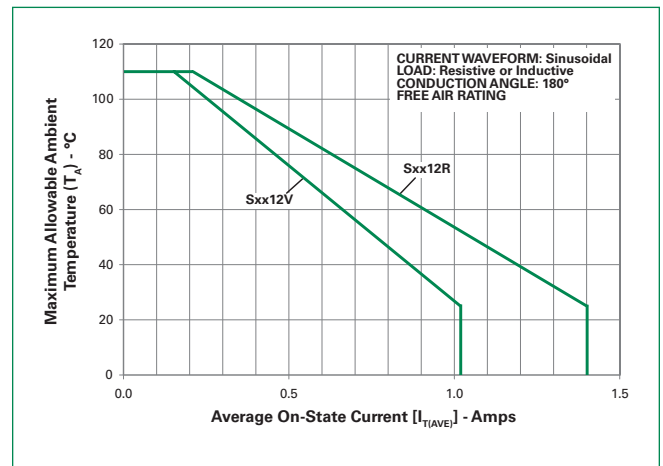

Figure 9: Maximum Allowable Ambient Temperature vs. Average On-State Current



Note: xx = voltage

Figure 10: Peak Capacitor Discharge Current

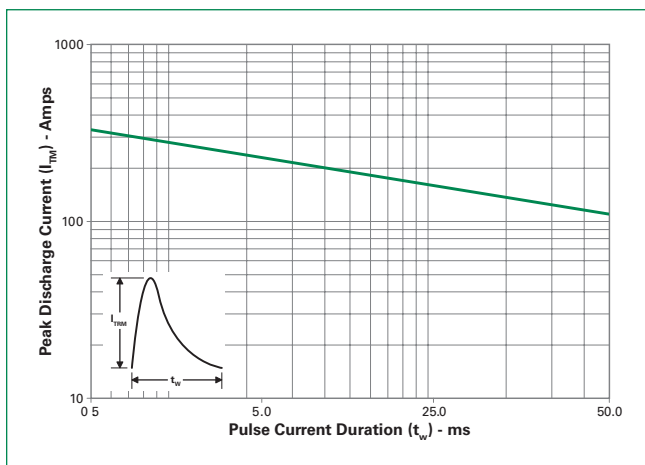

Figure 11: Peak Capacitor Discharge Current Derating

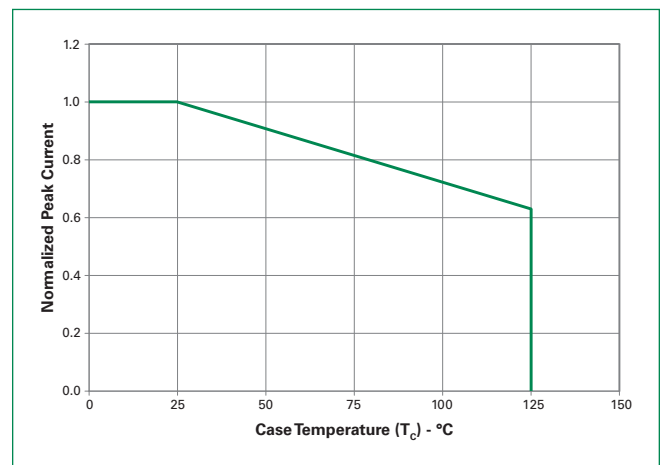
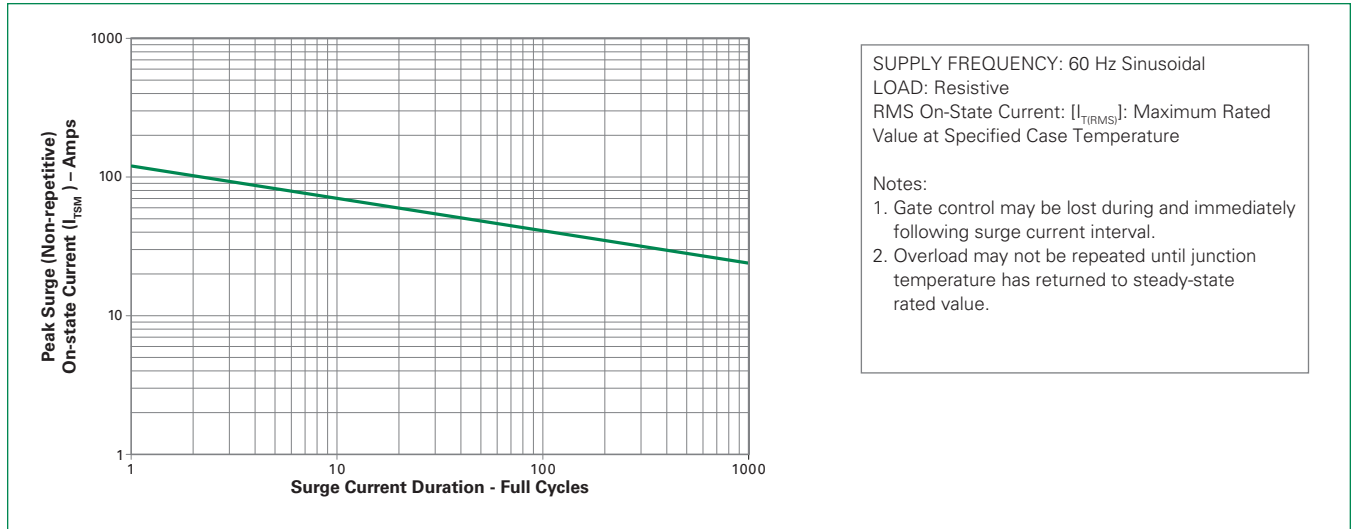
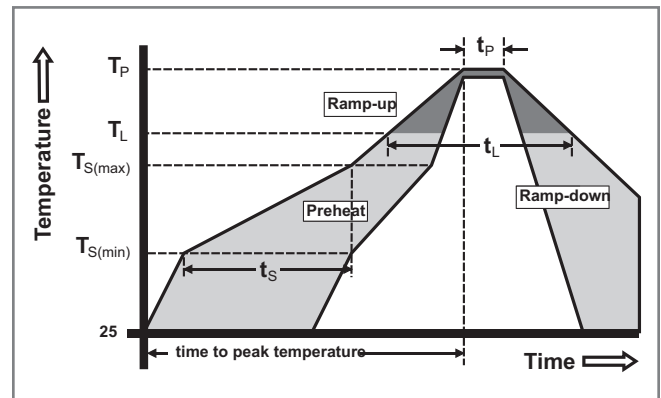

Figure 12: Surge Peak On-State Current vs. Number of Cycles



Soldering Parameters

| | | |
|--|------------------------------------|-------------------------|
| Reflow Condition | | Pb – Free assembly |
| Pre Heat | - Temperature Min ($T_{s(min)}$) | 150°C |
| | - Temperature Max ($T_{s(max)}$) | 200°C |
| | - Time (min to max) (t_s) | 60 – 180 secs |
| Average ramp up rate (Liquidus Temp) (T_L) to peak | | 5°C/second max |
| $T_{s(max)}$ to T_L - Ramp-up Rate | | 5°C/second max |
| Reflow | - Temperature (T_L) (Liquidus) | 217°C |
| | - Temperature (t_l) | 60 – 150 seconds |
| Peak Temperature (T_p) | | 260 ^{+0/-5} °C |
| Time within 5°C of actual peak Temperature (t_p) | | 20 – 40 seconds |
| Ramp-down Rate | | 5°C/second max |
| Time 25°C to peak Temperature (T_p) | | 8 minutes Max. |
| Do not exceed | | 280°C |



Physical Specifications

| | |
|------------------------|---|
| Terminal Finish | 100% Matte Tin-plated |
| Body Material | UL recognized epoxy meeting flammability classification 94V-0 |
| Lead Material | Copper Alloy |

Design Considerations

Careful selection of the correct device for the application's operating parameters and environment will go a long way toward extending the operating life of the Thyristor. Good design practice should limit the maximum continuous current through the main terminals to 75% of the device rating. Other ways to ensure long life for a power discrete semiconductor are proper heat sinking and selection of voltage ratings for worst case conditions. Overheating, overvoltage (including dv/dt), and surge currents are the main killers of semiconductors. Correct mounting, soldering, and forming of the leads also help protect against component damage.

Environmental Specifications

| Test | Specifications and Conditions |
|----------------------------------|---|
| AC Blocking | MIL-STD-750, M-1040, Cond A Applied Peak AC voltage @ 125°C for 1008 hours |
| Temperature Cycling | MIL-STD-750, M-1051, 100 cycles; -40°C to +150°C; 15-min dwell-time |
| Temperature/Humidity | EIA / JEDEC, JESD22-A101 1008 hours; 320V - DC: 85°C; 85% rel humidity |
| High Temp Storage | MIL-STD-750, M-1031, 1008 hours; 150°C |
| Low-Temp Storage | 1008 hours; -40°C |
| Thermal Shock | MIL-STD-750, M-1056 10 cycles; 0°C to 100°C; 5-min dwell-time at each temperature; 10 sec (max) transfer time between temperature |
| Autoclave | EIA / JEDEC, JESD22-A102 168 hours (121°C at 2 ATMs) and 100% R/H |
| Resistance to Solder Heat | MIL-STD-750 Method 2031 |
| Solderability | ANSI/J-STD-002, category 3, Test A |
| Lead Bend | MIL-STD-750, M-2036 Cond E |

Dimensions — TO-220AB (R-Package) — Non-Isolated Mounting Tab Common with Center Lead

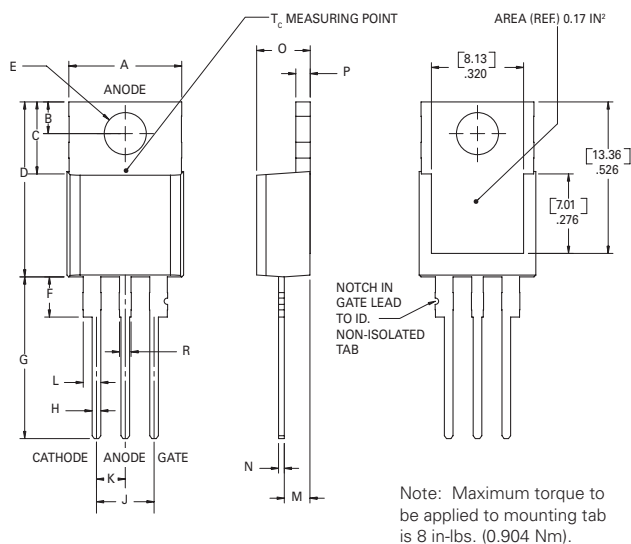

| Dimension | Inches | | Millimeters | |
|-----------|--------|-------|-------------|-------|
| | Min | Max | Min | Max |
| A | 0.380 | 0.420 | 9.65 | 10.67 |
| B | 0.105 | 0.115 | 2.67 | 2.92 |
| C | 0.230 | 0.250 | 5.84 | 6.35 |
| D | 0.590 | 0.620 | 14.99 | 15.75 |
| E | 0.142 | 0.147 | 3.61 | 3.73 |
| F | 0.110 | 0.130 | 2.79 | 3.30 |
| G | 0.540 | 0.575 | 13.72 | 14.61 |
| H | 0.025 | 0.035 | 0.64 | 0.89 |
| J | 0.195 | 0.205 | 4.95 | 5.21 |
| K | 0.095 | 0.105 | 2.41 | 2.67 |
| L | 0.060 | 0.075 | 1.52 | 1.91 |
| M | 0.085 | 0.095 | 2.16 | 2.41 |
| N | 0.018 | 0.024 | 0.46 | 0.61 |
| O | 0.178 | 0.188 | 4.52 | 4.78 |
| P | 0.045 | 0.060 | 1.14 | 1.52 |
| R | 0.038 | 0.048 | 0.97 | 1.22 |

Dimensions — TO-251AA (V/I-Package) — V/I-PAK Through Hole

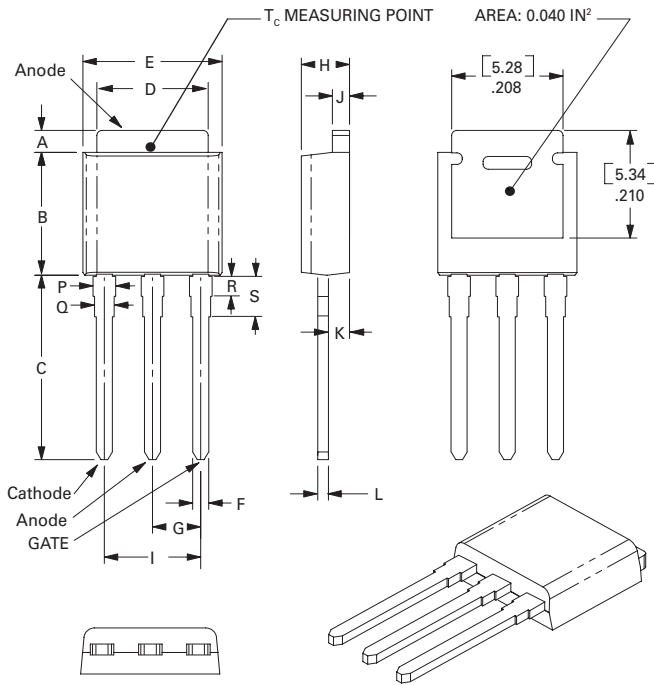

| Dimension | Inches | | | Millimeters | | |
|-----------|--------|-------|-------|-------------|------|------|
| | Min | Typ | Max | Min | Typ | Max |
| A | 0.040 | 0.044 | 0.050 | 1.02 | 1.11 | 1.27 |
| B | 0.235 | 0.242 | 0.245 | 5.97 | 6.15 | 6.22 |
| C | 0.350 | 0.361 | 0.375 | 8.89 | 9.18 | 9.53 |
| D | 0.205 | 0.208 | 0.213 | 5.21 | 5.29 | 5.41 |
| E | 0.255 | 0.262 | 0.265 | 6.48 | 6.66 | 6.73 |
| F | 0.027 | 0.031 | 0.033 | 0.69 | 0.80 | 0.84 |
| G | 0.087 | 0.090 | 0.093 | 2.21 | 2.28 | 2.36 |
| H | 0.085 | 0.092 | 0.095 | 2.16 | 2.34 | 2.41 |
| I | 0.176 | 0.180 | 0.184 | 4.47 | 4.57 | 4.67 |
| J | 0.018 | 0.020 | 0.023 | 0.46 | 0.51 | 0.58 |
| K | 0.038 | 0.040 | 0.044 | 0.97 | 1.01 | 1.12 |
| L | 0.018 | 0.020 | 0.023 | 0.46 | 0.52 | 0.58 |
| P | 0.042 | 0.047 | 0.052 | 1.06 | 1.20 | 1.32 |
| Q | 0.034 | 0.039 | 0.044 | 0.86 | 1.00 | 1.11 |
| R | 0.034 | 0.039 | 0.044 | 0.86 | 1.00 | 1.11 |
| S | 0.074 | 0.079 | 0.084 | 1.86 | 2.00 | 2.11 |

Dimensions — TO-252AA (D-Package) — D-PAK Surface Mount

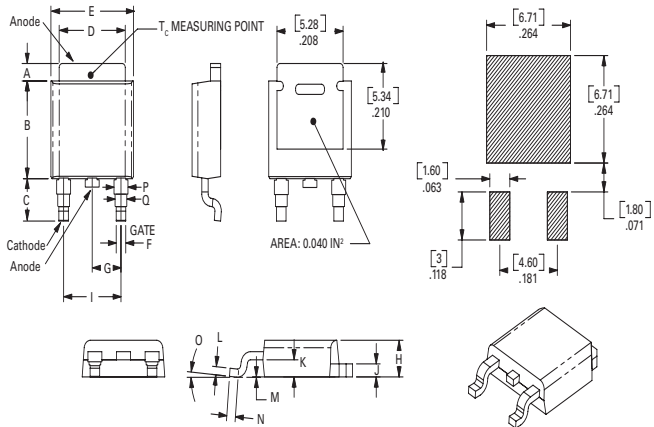

| Dimension | Inches | | | Millimeters | | |
|-----------|--------|-------|-------|-------------|------|------|
| | Min | Typ | Max | Min | Typ | Max |
| A | 0.040 | 0.043 | 0.050 | 1.02 | 1.09 | 1.27 |
| B | 0.235 | 0.243 | 0.245 | 5.97 | 6.16 | 6.22 |
| C | 0.106 | 0.108 | 0.113 | 2.69 | 2.74 | 2.87 |
| D | 0.205 | 0.208 | 0.213 | 5.21 | 5.29 | 5.41 |
| E | 0.255 | 0.262 | 0.265 | 6.48 | 6.65 | 6.73 |
| F | 0.027 | 0.031 | 0.033 | 0.69 | 0.80 | 0.84 |
| G | 0.087 | 0.090 | 0.093 | 2.21 | 2.28 | 2.36 |
| H | 0.085 | 0.092 | 0.095 | 2.16 | 2.33 | 2.41 |
| I | 0.176 | 0.179 | 0.184 | 4.47 | 4.55 | 4.67 |
| J | 0.018 | 0.020 | 0.023 | 0.46 | 0.51 | 0.58 |
| K | 0.038 | 0.040 | 0.044 | 0.97 | 1.02 | 1.12 |
| L | 0.018 | 0.020 | 0.023 | 0.46 | 0.51 | 0.58 |
| M | 0.000 | 0.000 | 0.004 | 0.00 | 0.00 | 0.10 |
| N | 0.021 | 0.026 | 0.027 | 0.53 | 0.67 | 0.69 |
| O | 0° | 0° | 5° | 0° | 0° | 5° |
| P | 0.042 | 0.047 | 0.052 | 1.06 | 1.20 | 1.32 |
| Q | 0.034 | 0.039 | 0.044 | 0.86 | 1.00 | 1.11 |

Product Selector

| Part Number | Voltage | | | | Gate Sensitivity | Type | Package |
|-------------|---------|------|------|-------|------------------|---------------|---------|
| | 400V | 600V | 800V | 1000V | | | |
| Sxx12R | X | X | X | X | 20mA | Sensitive SCR | TO-220R |
| Sxx12V | X | X | X | X | 20mA | Standard SCR | TO-251 |
| Sxx12D | X | X | X | X | 20mA | Standard SCR | TO-252 |

Note: xx = voltage

Packing Options

| Part Number | Marking | Weight | Packing Mode | Base Quantity |
|-------------|---------|--------|------------------|-------------------|
| Sxx12R | Sxx12R | 2.2 g | Bulk | 500 |
| Sxx12RTP | Sxx12R | 2.2 g | Tube | 500 (50 per tube) |
| Sxx12DTP | Sxx12D | 0.3 g | Tube | 750 (75 per tube) |
| Sxx12DRP | Sxx12D | 0.3 g | Embossed Carrier | 2500 |
| Sxx12VTP | Sxx12V | 0.4 g | Tube | 750 (75 per tube) |

Note: xx = Voltage

TO-252 Embossed Carrier Reel Pack (RP) Specifications

Meets all EIA-481-2 Standards

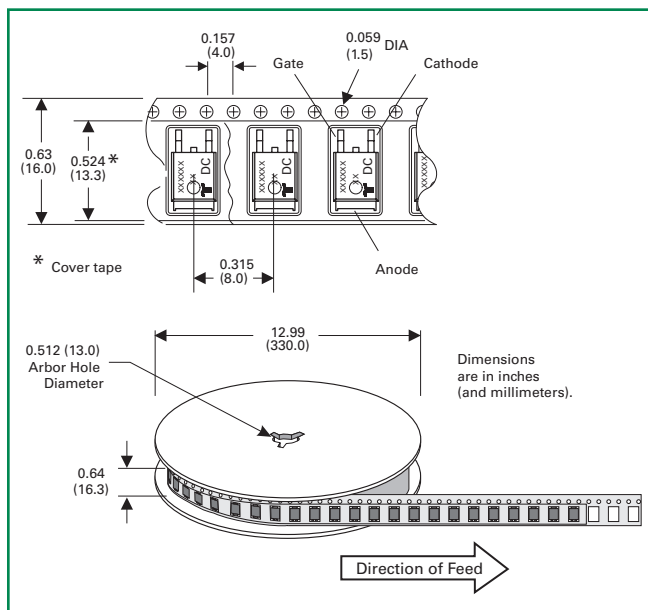

Part Marking System

TO-220 AB – (R Package)

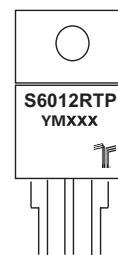

TO-251AA – (V Package)

TO-252AA – (D Package)

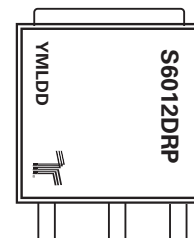

Part Numbering System

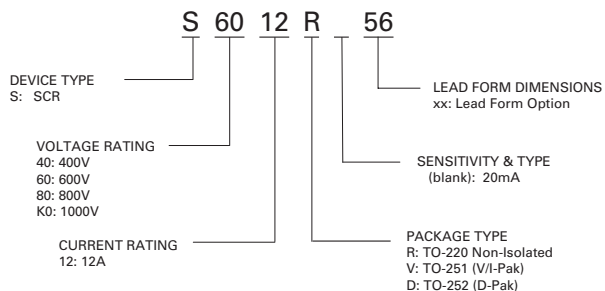

Компания «Life Electronics» занимается поставками электронных компонентов импортного и отечественного производства от производителей и со складов крупных дистрибьюторов Европы, Америки и Азии.

С конца 2013 года компания активно расширяет линейку поставок компонентов по направлению коаксиальный кабель, кварцевые генераторы и конденсаторы (керамические, пленочные, электролитические), за счёт заключения дистрибьюторских договоров

Мы предлагаем:

- Конкурентоспособные цены и скидки постоянным клиентам.
- Специальные условия для постоянных клиентов.
- Подбор аналогов.
- Поставку компонентов в любых объемах, удовлетворяющих вашим потребностям.
- Приемлемые сроки поставки, возможна ускоренная поставка.
- Доставку товара в любую точку России и стран СНГ.
- Комплексную поставку.
- Работу по проектам и поставку образцов.
- Формирование склада под заказчика.
- Сертификаты соответствия на поставляемую продукцию (по желанию клиента).
- Тестирование поставляемой продукции.
- Поставку компонентов, требующих военную и космическую приемку.
- Входной контроль качества.
- Наличие сертификата ISO.

В составе нашей компании организован Конструкторский отдел, призванный помогать разработчикам, и инженерам.

Конструкторский отдел помогает осуществить:

- Регистрацию проекта у производителя компонентов.
- Техническую поддержку проекта.
- Защиту от снятия компонента с производства.
- Оценку стоимости проекта по компонентам.
- Изготовление тестовой платы монтаж и пусконаладочные работы.



Тел: +7 (812) 336 43 04 (многоканальный)

Email: org@lifeelectronics.ru