

## Optocoupler, Phototriac Output, 400 V $V_{DRM}$

### Features

- Isolation materials according to UL 94-VO
- Pollution degree 2 (DIN/VDE 0110 resp. IEC 60664)
- Climatic classification 55/100/21 (IEC 60068 part 1)
- Special construction: Therefore, extra low coupling capacity of typical 0.2 pF, high **Common Mode Rejection**
- $I_{FT}$  offered into 4 groups
- Rated impulse voltage (transient overvoltage)  $V_{IOTM} = 6$  kV peak
- Isolation test voltage (partial discharge test voltage)  $V_{pd} = 1.6$  kV
- Rated isolation voltage (RMS includes DC)  $V_{IOWM} = 600 V_{RMS}$  (848 V peak)
- Rated recurring peak voltage (repetitive)  $V_{IORM} = 600 V_{RMS}$
- Thickness through insulation  $\geq 0.75$  mm
- Creepage current resistance according to VDE 0303/IEC 60112 **Comparative Tracking Index: CTI = 275**
- Lead-free component
- Component in accordance to RoHS 2002/95/EC and WEEE 2002/96/EC

### Agency Approvals

- UL1577, File No. E76222 System Code C, Double Protection
- BSI: BS EN 41003, BS EN 60095 (BS 415), BS EN 60950 (BS 7002), Certificate number 7081 and 7402
- DIN EN 60747-5-2 (VDE0884)  
DIN EN 60747-5-5 pending
- FIMKO (SETI): EN 60950, Certificate No. 12398

### Applications

Monitors  
Air conditioners  
Line Switches  
Solid state relay  
Microwave

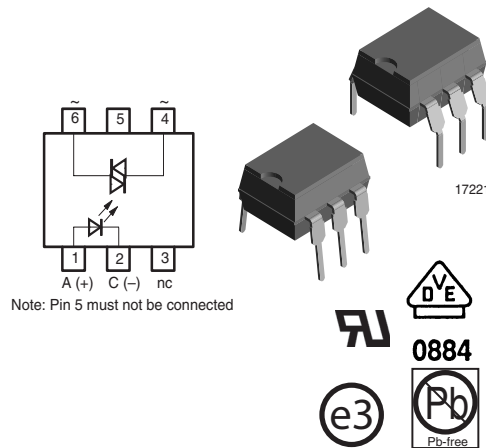

Circuits for safe protective separation against electrical shock according to safety class II (reinforced isolation):

- For appl. class I - IV at mains voltage  $\leq 300$  V
- For appl. class I - III at mains voltage  $\leq 600$  V according to DIN EN 60747-5-2(VDE0884)/ DIN EN 60747-5-5 pending, table 2, suitable for.

### Order Information

Part	Remarks
K3020P	$I_{FT} < 30$ mA, $V_{DRM} = 400$ V, DIP-6 300 mil
K3021P	$I_{FT} < 15$ mA, $V_{DRM} = 400$ V, DIP-6 300 mil
K3022P	$I_{FT} < 10$ mA, $V_{DRM} = 400$ V, DIP-6 300 mil
K3023P	$I_{FT} < 5$ mA, $V_{DRM} = 400$ V, DIP-6 300 mil
K3036P	$I_{FT} < 3.6$ mA, $V_{DRM} = 400$ V, DIP-6 300 mil
K3020PG	$I_{FT} < 30$ mA, $V_{DRM} = 400$ V, DIP-6 400 mil
K3021PG	$I_{FT} < 15$ mA, $V_{DRM} = 400$ V, DIP-6 400 mil
K3022PG	$I_{FT} < 10$ mA, $V_{DRM} = 400$ V, DIP-6 400 mil
K3023PG	$I_{FT} < 5$ mA, $V_{DRM} = 400$ V, DIP-6 400 mil
K3036PG	$I_{FT} < 3.6$ mA, $V_{DRM} = 400$ V, DIP-6 400 mil

G = Leadform 10.16 mm; G is not marked on the body

### Description

The K3020P/ K3020PG series consists of a phototransistor optically coupled to a gallium arsenide infrared-emitting diode in a 6-lead plastic dual inline package.

# K3020P/ K3020PG Series



## Vishay Semiconductors

### VDE Standards

These couplers perform safety functions according to the following equipment standards:

**DIN EN 60747-5-2(VDE0884)/ DIN EN 60747-5-5 pending**

Optocoupler for electrical safety requirements

**IEC 60950/EN 60950**

Office machines (applied for reinforced isolation for mains voltage  $\leq 400$  VRMS)

### VDE 0804

Telecommunication apparatus and data processing

**IEC 60065**

Safety for mains-operated electronic and related household apparatus.

## Absolute Maximum Ratings

$T_{amb} = 25$  °C, unless otherwise specified

Stresses in excess of the absolute Maximum Ratings can cause permanent damage to the device. Functional operation of the device is not implied at these or any other conditions in excess of those given in the operational sections of this document. Exposure to absolute Maximum Rating for extended periods of the time can adversely affect reliability.

## Input

Parameter	Test condition	Symbol	Value	Unit
Reverse voltage		$V_R$	5	V
Forward current		$I_F$	80	mA
Forward surge current	$t_p \leq 10$ $\mu$ s	$I_{FSM}$	3	A
Power dissipation		$P_{diss}$	100	mW
Junction temperature		$T_j$	100	°C

## Output

Parameter	Test condition	Symbol	Value	Unit
Off state output terminal voltage		$V_{DRM}$	400	V
On state RMS current		$I_{TRM}$	100	mA
Peak surge current, non-repetitive	$t_p \leq 10$ ms	$I_{TSM}$	1.5	A
Power dissipation		$P_{diss}$	300	mW
Junction temperature		$T_j$	100	°C

## Coupler

Parameter	Test condition	Symbol	Value	Unit
Isolation test voltage (RMS)		$V_{ISO}^{1)}$	3750	$V_{RMS}$
Total power dissipation		$P_{tot}$	350	mW
Ambient temperature range		$T_{amb}$	- 40 to + 85	°C
Storage temperature range		$T_{stg}$	- 55 to + 100	°C
Soldering temperature	2 mm from case, $t \leq 10$ s	$T_{sld}$	260	°C

<sup>1)</sup> Related to standard climate 23/50 DIN 50014



## Electrical Characteristics

$T_{amb} = 25\text{ }^{\circ}\text{C}$ , unless otherwise specified

Minimum and maximum values are testing requirements. Typical values are characteristics of the device and are the result of engineering evaluation. Typical values are for information only and are not part of the testing requirements.

## Input

Parameter	Test condition	Symbol	Min	Typ.	Max	Unit
Forward voltage	$I_F = 50\text{ mA}$	$V_F$		1.25	1.6	V
Junction capacitance	$V_R = 0, f = 1\text{ MHz}$	$C_j$		50		pF

## Output

Parameter	Test condition	Symbol	Min	Typ.	Max	Unit
Forward peak off-state voltage (repetitive)	$I_{DRM} = 100\text{ nA}$	$V_{DRM}^{1)}$	400			V
Peak on-state voltage	$I_{TM} = 100\text{ mA}$	$V_{TM}$		1.5	3	V
Critical rate of rise of off-state voltage	$I_{FT} = 0, I_{FT} = 30\text{ mA}$	$dV/dt_{cr}$		10		V/ $\mu\text{s}$
		$dV/dt_{crq}$	0.1	0.2		V/ $\mu\text{s}$

<sup>1)</sup> Test voltage must be applied within dv/dt ratings

## Coupler

Parameter	Test condition	Part	Symbol	Min	Typ.	Max	Unit
Emitting diode trigger current	$V_S = 3\text{ V}, R_L = 150\ \Omega$	K3020P	$I_{FT}$		15	30	mA
		K3020PG	$I_{FT}$		15	30	mA
		K3021P	$I_{FT}$		8	15	mA
		K3021PG	$I_{FT}$		8	15	mA
		K3022P	$I_{FT}$		5	10	mA
		K3022PG	$I_{FT}$		5	10	mA
		K3023P	$I_{FT}$		2	5	mA
		K3023PG	$I_{FT}$		2	5	mA
		K3036P	$I_{FT}$		2	3.6	mA
		K3036PG	$I_{FT}$		2	3.6	mA
Holding current	$I_F = 10\text{ mA}, V_S \geq 3\text{ V}$		$I_H$		100	$\mu\text{A}$	

Note:  $I_{FT}$  is defined as a minimum trigger current



Test condition:  
 $dV/dt_{cr}$   
 $V_S = 2/3 V_{DRM}$   
 (Sine wave)  
 $R_L = 33\text{ k}$   
 $dV/dt_{crq}$   
 $V_{eff} = 30\text{ V}$   
 (Sine wave)  
 $R_L = 2\text{ k}$

Figure 1. Test circuit for  $dV/dt_{cr}$  and  $dV/dt_{crq}$

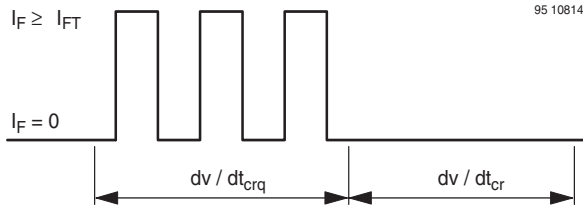

$dV/dt_{cr}$  Highest value of the “rate of rise of off-state voltage” which does not cause any switching from the off-state to the on-state  
 $dV/dt_{crq}$  Highest value of the “rate of rise of communicating voltage” which does not switch on the device again, after the voltage has decreased to zero and the trigger current is switched from  $I_{FT}$  to zero

Figure 2.



Figure 3. Motor control circuit

## Maximum Safety Ratings

(according to DIN EN 60747-5-2(VDE0884)/ DIN EN 60747-5-5 pending) see figure 1  
 This optocoupler is suitable for safe electrical isolation only within the safety ratings.  
 Compliance with the safety ratings shall be ensured by means of suitable protective circuits.

## Input

Parameter	Test condition	Symbol	Min	Typ.	Max	Unit
Forward current		$I_F$			130	mA

## Output

Parameter	Test condition	Symbol	Min	Typ.	Max	Unit
Power dissipation		$P_{diss}$			600	mW

## Coupler

Parameter	Test condition	Symbol	Min	Typ.	Max	Unit
Rated impulse voltage		$V_{IOTM}$			6	kV
Safety temperature		$T_{si}$			150	°C

## Insulation Rated Parameters

Parameter	Test condition	Symbol	Min	Typ.	Max	Unit
Partial discharge test voltage - Routine test	100 %, $t_{test} = 1$ s	$V_{pd}$	1.6			kV
Partial discharge test voltage - Lot test (sample test)	$t_{Tr} = 60$ s, $t_{test} = 10$ s, (see figure 5)	$V_{IOTM}$	6			kV
		$V_{pd}$	1.3			kV
Insulation resistance	$V_{IO} = 500$ V	$R_{IO}$	$10^{12}$			$\Omega$
	$V_{IO} = 500$ V, $T_{amb} = 100$ °C	$R_{IO}$	$10^{11}$			$\Omega$
	$V_{IO} = 500$ V, $T_{amb} = 150$ °C (construction test only)	$R_{IO}$	$10^9$			$\Omega$



Figure 4. Derating diagram



Figure 5. Test pulse diagram for sample test according to DIN EN 60747-5-2(VDE0884)/ DIN EN 60747-; IEC60747

## Typical Characteristics (T<sub>amb</sub> = 25 °C unless otherwise specified)



Figure 6. Total Power Dissipation vs. Ambient Temperature



Figure 9. Relative On - State vs. Ambient Temperature



Figure 7. Forward Current vs. Forward Voltage



Figure 10. Off - State Current vs. Ambient Temperature



Figure 8. Relative Threshold Forward Current vs. Ambient Temperature



Figure 11. On - State Current vs. Ambient Temperature

Figure 12. On - State Current vs. Ambient Temperature



## Package Dimensions in mm



# K3020P/ K3020PG Series



Vishay Semiconductors

## Package Dimensions in mm

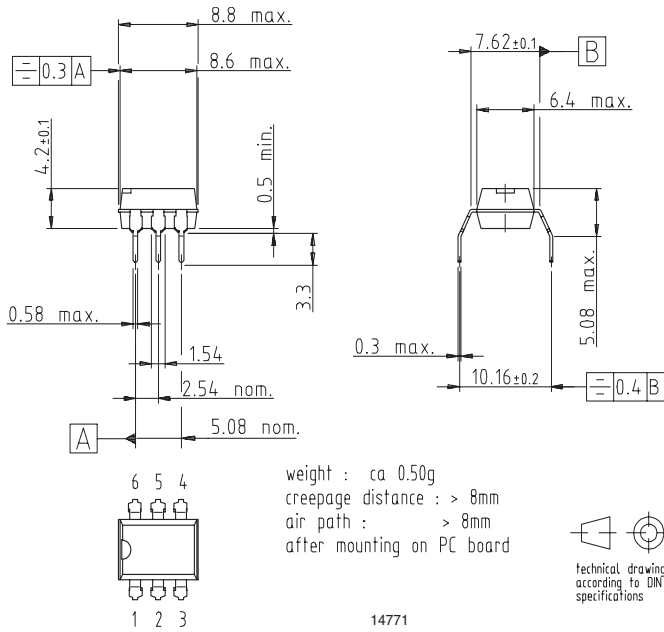





## Ozone Depleting Substances Policy Statement

It is the policy of Vishay Semiconductor GmbH to

1. Meet all present and future national and international statutory requirements.
2. Regularly and continuously improve the performance of our products, processes, distribution and operating systems with respect to their impact on the health and safety of our employees and the public, as well as their impact on the environment.

It is particular concern to control or eliminate releases of those substances into the atmosphere which are known as ozone depleting substances (ODSs).

The Montreal Protocol (1987) and its London Amendments (1990) intend to severely restrict the use of ODSs and forbid their use within the next ten years. Various national and international initiatives are pressing for an earlier ban on these substances.

Vishay Semiconductor GmbH has been able to use its policy of continuous improvements to eliminate the use of ODSs listed in the following documents.

1. Annex A, B and list of transitional substances of the Montreal Protocol and the London Amendments respectively
2. Class I and II ozone depleting substances in the Clean Air Act Amendments of 1990 by the Environmental Protection Agency (EPA) in the USA
3. Council Decision 88/540/EEC and 91/690/EEC Annex A, B and C (transitional substances) respectively.

Vishay Semiconductor GmbH can certify that our semiconductors are not manufactured with ozone depleting substances and do not contain such substances.

We reserve the right to make changes to improve technical design and may do so without further notice.

Parameters can vary in different applications. All operating parameters must be validated for each customer application by the customer. Should the buyer use Vishay Semiconductors products for any unintended or unauthorized application, the buyer shall indemnify Vishay Semiconductors against all claims, costs, damages, and expenses, arising out of, directly or indirectly, any claim of personal damage, injury or death associated with such unintended or unauthorized use.

Vishay Semiconductor GmbH, P.O.B. 3535, D-74025 Heilbronn, Germany  
Telephone: 49 (0)7131 67 2831, Fax number: 49 (0)7131 67 2423



### Notice

Specifications of the products displayed herein are subject to change without notice. Vishay Intertechnology, Inc., or anyone on its behalf, assumes no responsibility or liability for any errors or inaccuracies.

Information contained herein is intended to provide a product description only. No license, express or implied, by estoppel or otherwise, to any intellectual property rights is granted by this document. Except as provided in Vishay's terms and conditions of sale for such products, Vishay assumes no liability whatsoever, and disclaims any express or implied warranty, relating to sale and/or use of Vishay products including liability or warranties relating to fitness for a particular purpose, merchantability, or infringement of any patent, copyright, or other intellectual property right.

The products shown herein are not designed for use in medical, life-saving, or life-sustaining applications. Customers using or selling these products for use in such applications do so at their own risk and agree to fully indemnify Vishay for any damages resulting from such improper use or sale.

Компания «Life Electronics» занимается поставками электронных компонентов импортного и отечественного производства от производителей и со складов крупных дистрибьюторов Европы, Америки и Азии.

С конца 2013 года компания активно расширяет линейку поставок компонентов по направлению коаксиальный кабель, кварцевые генераторы и конденсаторы (керамические, пленочные, электролитические), за счёт заключения дистрибьюторских договоров

Мы предлагаем:

- Конкуренспособные цены и скидки постоянным клиентам.
- Специальные условия для постоянных клиентов.
- Подбор аналогов.
- Поставку компонентов в любых объемах, удовлетворяющих вашим потребностям.
- Приемлемые сроки поставки, возможна ускоренная поставка.
- Доставку товара в любую точку России и стран СНГ.
- Комплексную поставку.
- Работу по проектам и поставку образцов.
- Формирование склада под заказчика.
- Сертификаты соответствия на поставляемую продукцию (по желанию клиента).
- Тестирование поставляемой продукции.
- Поставку компонентов, требующих военную и космическую приемку.
- Входной контроль качества.
- Наличие сертификата ISO.

В составе нашей компании организован Конструкторский отдел, призванный помогать разработчикам, и инженерам.

Конструкторский отдел помогает осуществить:

- Регистрацию проекта у производителя компонентов.
- Техническую поддержку проекта.
- Защиту от снятия компонента с производства.
- Оценку стоимости проекта по компонентам.
- Изготовление тестовой платы монтаж и пусконаладочные работы.



Тел: +7 (812) 336 43 04 (многоканальный)  
Email: [org@lifeelectronics.ru](mailto:org@lifeelectronics.ru)