

## Optocoupler, Phototransistor Output, High Reliability, 5300 V<sub>RMS</sub>, 110 °C Rated

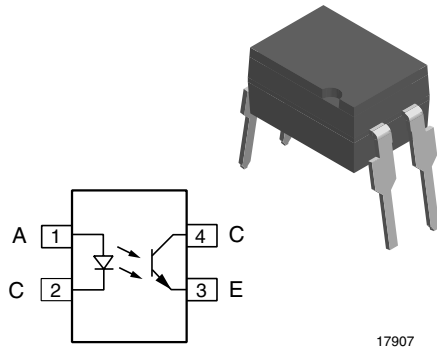

### DESCRIPTION

The 110 °C rated SFH1617A (DIP) feature a high current transfer ratio, low coupling capacitance and high isolation voltage. These couplers have a GaAs infrared diode emitter, which is optically coupled to a silicon planar phototransistor detector, and is incorporated in a plastic DIP-4 package.

The coupling devices are designed for signal transmission between two electrically separated circuits.

The couplers are end-stackable with 2.54 mm spacing. Creepage and clearance distances of > 8.0 mm are achieved with option 6. This version complies with IEC 60950 (DIN VDE 0805) for reinforced insulation up to an operation voltage of 400 V<sub>RMS</sub> or DC. Specifications subject to change.

### FEATURES

- Operating temperature from - 55 °C to + 110 °C
- Good CTR linearity depending on forward current
- Isolation test voltage, 5300 V<sub>RMS</sub>
- High collector emitter voltage, V<sub>CEO</sub> = 70 V
- Low saturation voltage
- Fast switching times
- Low CTR degradation
- Temperature stable
- Low coupling capacitance
- End stackable, 0.100" (2.54 mm) spacing
- High common mode interference immunity
- Lead (Pb)-free component
- Component in accordance to RoHS 2002/95/EC and WEEE 2002/96/EC

**RoHS**  
COMPLIANT

### APPLICATIONS

- AC adapter
- SMPS
- PLC
- Factory automation
- Game consoles

### AGENCY APPROVALS

- UL1577, file no. E52744 system code H or J, double protection
- CSA 93751
- DIN EN 60747-5-2 (VDE 0884)/DIN EN 60747-5-5 pending available with option 1
- BSI IEC 60950; IEC 60065

ORDER INFORMATION	
PART	REMARKS
SFH1617A-1	CTR 40 to 80 %, DIP-4
SFH1617A-2	CTR 63 to 125 %, DIP-4
SFH1617A-3	CTR 100 to 200 %, DIP-4
SFH1617A-4	CTR 160 to 320 %, DIP-4

ABSOLUTE MAXIMUM RATINGS (1)				
PARAMETER	TEST CONDITION	SYMBOL	VALUE	UNIT
<b>INPUT</b>				
Reverse voltage		V <sub>R</sub>	6.0	V
DC forward current		I <sub>F</sub>	60	mA
Surge forward current	t ≤ 10 μs	I <sub>FSM</sub>	2.5	A
Derate linearly from 25 °C			0.95	mW/°C

ABSOLUTE MAXIMUM RATINGS (1)				
PARAMETER	TEST CONDITION	SYMBOL	VALUE	UNIT
<b>OUTPUT</b>				
Collector emitter voltage		V <sub>CE</sub>	70	V
Emitter collector voltage		V <sub>EC</sub>	7.0	V
Collector current		I <sub>C</sub>	50	mA
	t ≤ 1.0 ms	I <sub>C</sub>	100	mA
Derate linearly from 25 °C			1.54	mW/°C
<b>COUPLER</b>				
Isolation test voltage between emitter and detector, refer to climate DIN 40046, part 2, Nov. 74		V <sub>ISO</sub>	5300	V <sub>RMS</sub>
Isolation resistance	V <sub>IO</sub> = 500 V, T <sub>amb</sub> = 25 °C	R <sub>IO</sub>	≥ 10 <sup>12</sup>	Ω
	V <sub>IO</sub> = 500 V, T <sub>amb</sub> = 100 °C	R <sub>IO</sub>	≥ 10 <sup>11</sup>	Ω
Storage temperature range		T <sub>stg</sub>	- 55 to + 150	°C
Ambient temperature range		T <sub>amb</sub>	- 55 to + 110	°C
Soldering temperature (2)	max. 10 s, dip soldering distance to seating plane ≥ 1.5 mm	T <sub>sld</sub>	260	°C

**Notes**

- (1) T<sub>amb</sub> = 25 °C, unless otherwise specified.  
Stresses in excess of the absolute maximum ratings can cause permanent damage to the device. Functional operation of the device is not implied at these or any other conditions in excess of those given in the operational sections of this document. Exposure to absolute maximum ratings for extended periods of the time can adversely affect reliability.
- (2) Refer to wave profile for soldering conditions for through hole devices.

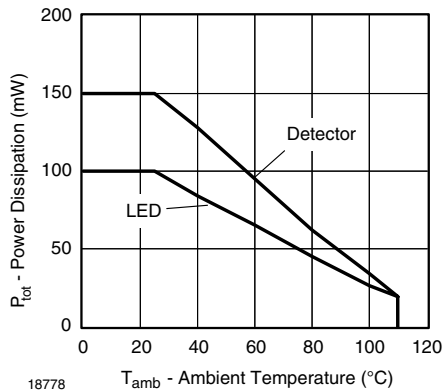

Fig. 1 - Permissible Power Dissipation vs. Ambient Temperature

Optocoupler, Phototransistor Output, Vishay Semiconductors  
High Reliability, 5300 V<sub>RMS</sub>, 110 °C  
Rated

<b>THERMAL CHARACTERISTICS (1)</b>				
PARAMETER	TEST CONDITION	SYMBOL	VALUE	UNIT
LED power dissipation	at 25 °C	P <sub>diss</sub>	100	mW
Output power dissipation	at 25 °C	P <sub>diss</sub>	150	mW
Maximum LED junction temperature		T <sub>Jmax</sub>	125	°C
Maximum output die junction temperature		T <sub>Jmax</sub>	125	°C
Thermal resistance, junction emitter to board		θ <sub>EB</sub>	173	°C/W
Thermal resistance, junction emitter to case		θ <sub>EC</sub>	149	°C/W
Thermal resistance, junction detector to board		θ <sub>DB</sub>	111	°C/W
Thermal resistance, junction detector to case		θ <sub>DC</sub>	127	°C/W
Thermal resistance, junction emitter to junction detector		θ <sub>ED</sub>	95	°C/W
Thermal resistance, board to ambient (2)		θ <sub>BA</sub>	195	°C/W
Thermal resistance, case to ambient (2)		θ <sub>CA</sub>	3573	°C/W

**Notes**

(1) The thermal model is represented in the thermal network below. Each resistance value given in this model can be used to calculate the temperatures at each node for a given operating condition. The thermal resistance from board to ambient will be dependent on the type of PCB, layout and thickness of copper traces. For a detailed explanation of the thermal model, please reference Vishay's thermal characteristics of optocouplers application note.

(2) For 2 layer FR4 board (4" x 3" x 0.062).

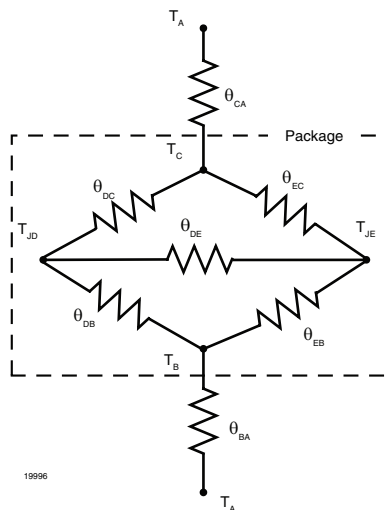

<b>ELECTRICAL CHARACTERISTICS</b>							
PARAMETER	TEST CONDITION	PART	SYMBOL	MIN.	TYP.	MAX.	UNIT
<b>INPUT</b>							
Forward voltage	I <sub>F</sub> = 60 mA		V <sub>F</sub>		1.25	1.65	V
Reverse current	V <sub>R</sub> = 6.0 V		I <sub>R</sub>		0.01	10	μA
Capacitance	V <sub>R</sub> = 0 V, f = 1.0 MHz		C <sub>O</sub>		13		pF
<b>OUTPUT</b>							
Collector emitter capacitance	V <sub>CE</sub> = 5.0 V, f = 1.0 MHz		C <sub>CE</sub>		5.2		pF
Collector emitter leakage current	V <sub>CE</sub> = 10 V	SFH1617A-1	I <sub>CEO</sub>		2.0	50	nA
		SFH1617A-2	I <sub>CEO</sub>		2.0	50	nA
		SFH1617A-3	I <sub>CEO</sub>		5.0	100	nA
		SFH1617A-4	I <sub>CEO</sub>		5.0	100	nA
<b>COUPLER</b>							

Vishay Semiconductors Optocoupler, Phototransistor Output,  
High Reliability, 5300 V<sub>RMS</sub>, 110 °C  
Rated

ELECTRICAL CHARACTERISTICS							
PARAMETER	TEST CONDITION	PART	SYMBOL	MIN.	TYP.	MAX.	UNIT
Collector emitter saturation voltage	I <sub>F</sub> = 10 mA, f = 1.0 MHz		V <sub>CEsat</sub>	0.4	0.25		V
Coupling capacitance			C <sub>C</sub>		0.4		pF

**Note**

T<sub>amb</sub> = 25 °C, unless otherwise specified.

Minimum and maximum values are testing requirements. Typical values are characteristics of the device and are the result of engineering evaluation. Typical values are for information only and are not part of the testing requirements.

CURRENT TRANSFER RATIO							
PARAMETER	TEST CONDITION	PART	SYMBOL	MIN.	TYP.	MAX.	UNIT
I <sub>C</sub> /I <sub>F</sub>	I <sub>F</sub> = 10 mA, V <sub>CE</sub> = 5.0 V	SFH1617A-1	CTR	40		80	%
		SFH1617A-2	CTR	63		125	%
		SFH1617A-3	CTR	100		200	%
		SFH1617A-4	CTR	160		320	%
	I <sub>F</sub> = 1.0 mA, V <sub>CE</sub> = 5.0 V	SFH1617A-1	CTR	13	30		%
		SFH1617A-2	CTR	22	45		%
		SFH1617A-3	CTR	34	70		%
		SFH1617A-4	CTR	56	90		%

SWITCHING CHARACTERISTICS							
PARAMETER	TEST CONDITION	PART	SYMBOL	MIN.	TYP.	MAX.	UNIT
<b>NON-SATURATED</b>							
Turn-on time	I <sub>F</sub> = 10 mA, V <sub>CC</sub> = 5.0 V, R <sub>L</sub> = 75 Ω		t <sub>on</sub>		3.0		μs
Rise time	I <sub>F</sub> = 10 mA, V <sub>CC</sub> = 5.0 V, R <sub>L</sub> = 75 Ω		t <sub>r</sub>		2.0		μs
Turn-off time	I <sub>F</sub> = 10 mA, V <sub>CC</sub> = 5.0 V, R <sub>L</sub> = 75 Ω		t <sub>off</sub>		2.3		μs
Fall time	I <sub>F</sub> = 10 mA, V <sub>CC</sub> = 5.0 V, R <sub>L</sub> = 75 Ω		t <sub>f</sub>		2.0		μs
Cut-off frequency	I <sub>F</sub> = 10 mA, V <sub>CC</sub> = 5.0 V		f <sub>ctr</sub>		250		kHz
<b>SATURATED</b>							
Turn-on time	I <sub>F</sub> = 20 mA	SFH1617A-1	t <sub>on</sub>		3.0		μs
	I <sub>F</sub> = 10 mA	SFH1617A-2	t <sub>on</sub>		4.2		μs
		SFH1617A-3	t <sub>on</sub>		4.2		μs
	I <sub>F</sub> = 5.0 mA	SFH1617A-4	t <sub>on</sub>		6.0		μs
Rise time	I <sub>F</sub> = 20 mA	SFH1617A-1	t <sub>r</sub>		2.0		μs
	I <sub>F</sub> = 10 mA	SFH1617A-2	t <sub>r</sub>		3.0		μs
		SFH1617A-3	t <sub>r</sub>		3.0		μs
	I <sub>F</sub> = 5.0 mA	SFH1617A-4	t <sub>r</sub>		4.6		μs
<b>SATURATED</b>							
Turn-off time	I <sub>F</sub> = 20 mA	SFH1617A-1	t <sub>off</sub>		18		μs
	I <sub>F</sub> = 10 mA	SFH1617A-2	t <sub>off</sub>		23		μs
		SFH1617A-3	t <sub>off</sub>		23		μs
	I <sub>F</sub> = 5.0 mA	SFH1617A-4	t <sub>off</sub>		25		μs
Fall time	I <sub>F</sub> = 20 mA	SFH1617A-1	t <sub>f</sub>		11		μs
	I <sub>F</sub> = 10 mA	SFH1617A-2	t <sub>f</sub>		14		μs
		SFH1617A-3	t <sub>f</sub>		14		μs
	I <sub>F</sub> = 5.0 mA	SFH1617A-4	t <sub>f</sub>		15		μs



Optocoupler, Phototransistor Output, Vishay Semiconductors  
 High Reliability, 5300 V<sub>RMS</sub>, 110 °C  
 Rated

SAFETY AND INSULATION RATINGS						
PARAMETER	TEST CONDITION	SYMBOL	MIN.	TYP.	MAX.	UNIT
Climatic classification (according to IEC 68 part 1)				55/110/21		
Comparative tracking index		CTI	175		399	
V <sub>IOTM</sub>			10000			V
V <sub>IORM</sub>			890			V
P <sub>SO</sub>					400	mW
I <sub>SI</sub>					275	mA
T <sub>SI</sub>					175	°C
Creepage distance	standard DIP-4		7			mm
Clearance distance	standard DIP-4		7			mm
Creepage distance	400 mil DIP-4		8			mm
Clearance distance	400 mil DIP-4		8			mm
Insulation thickness, reinforced rated	per IEC 60950 2.10.5.1		0.4			mm

**Note**

As per IEC 60747-5-2, § 7.4.3.8.1, this optocoupler is suitable for "safe electrical insulation" only within the safety ratings. Compliance with the safety ratings shall be ensured by means of protective circuits.

**TYPICAL CHARACTERISTICS**

T<sub>amb</sub> = 25 °C, unless otherwise specified

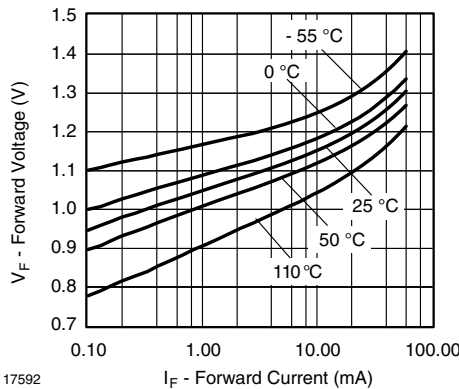

Fig. 2 - Forward Voltage vs. Forward Current

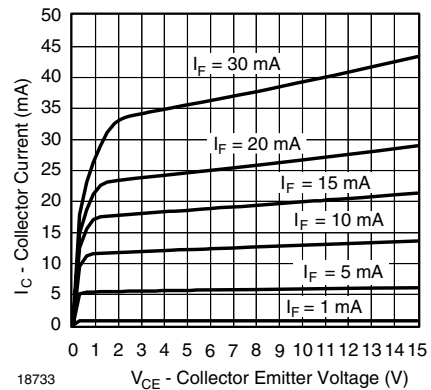

Fig. 3 - Collector Current vs. Collector Emitter Voltage

Vishay Semiconductors Optocoupler, Phototransistor Output,  
High Reliability, 5300 V<sub>RMS</sub>, 110 °C  
Rated

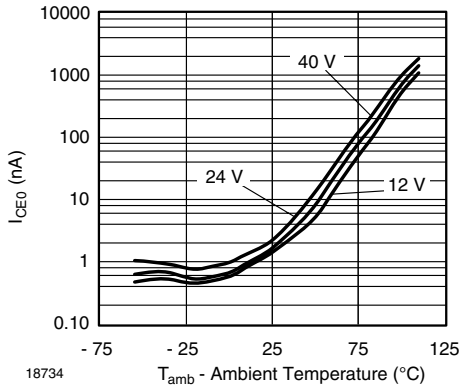

Fig. 4 - Collector to Emitter Dark Current vs. Ambient Temperature

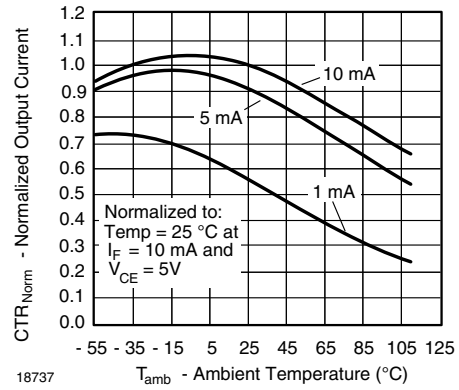

Fig. 7 - Normalized CTR vs. Temperature

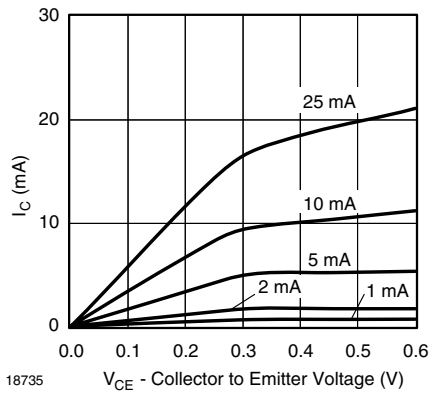

Fig. 5 - Normalized Current vs. Collector Emitter Saturation Voltage

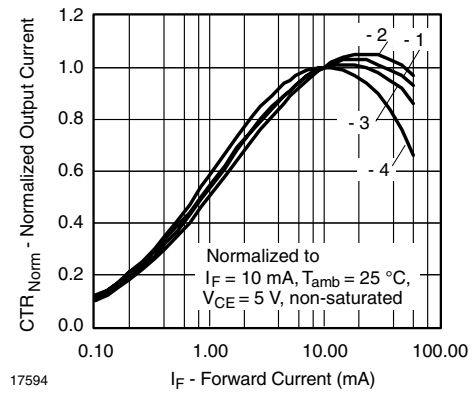

Fig. 8 - Normalized CTR vs. Forward Current

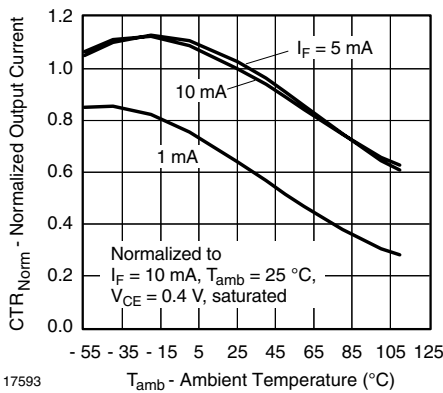

Fig. 6 - Normalized Current Transfer Ratio vs. Ambient Temperature

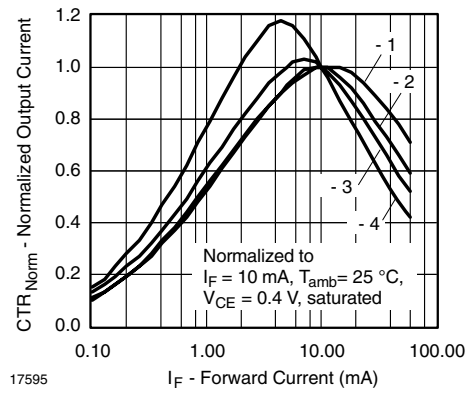

Fig. 9 - Normalized CTR vs. Forward Current

Optocoupler, Phototransistor Output, Vishay Semiconductors  
 High Reliability, 5300 V<sub>RMS</sub>, 110 °C  
 Rated

Fig. 10 - Forward Resistance vs. Forward Current

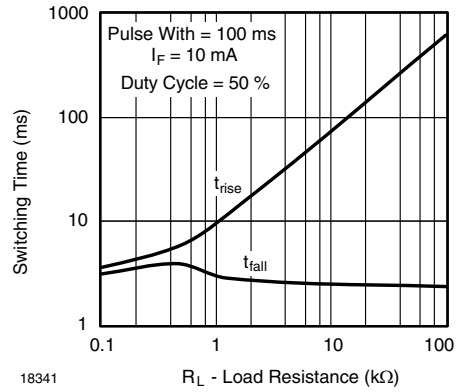
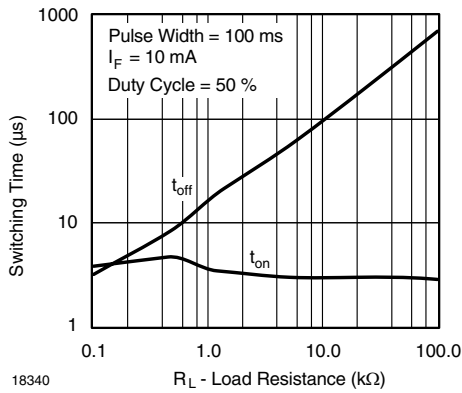
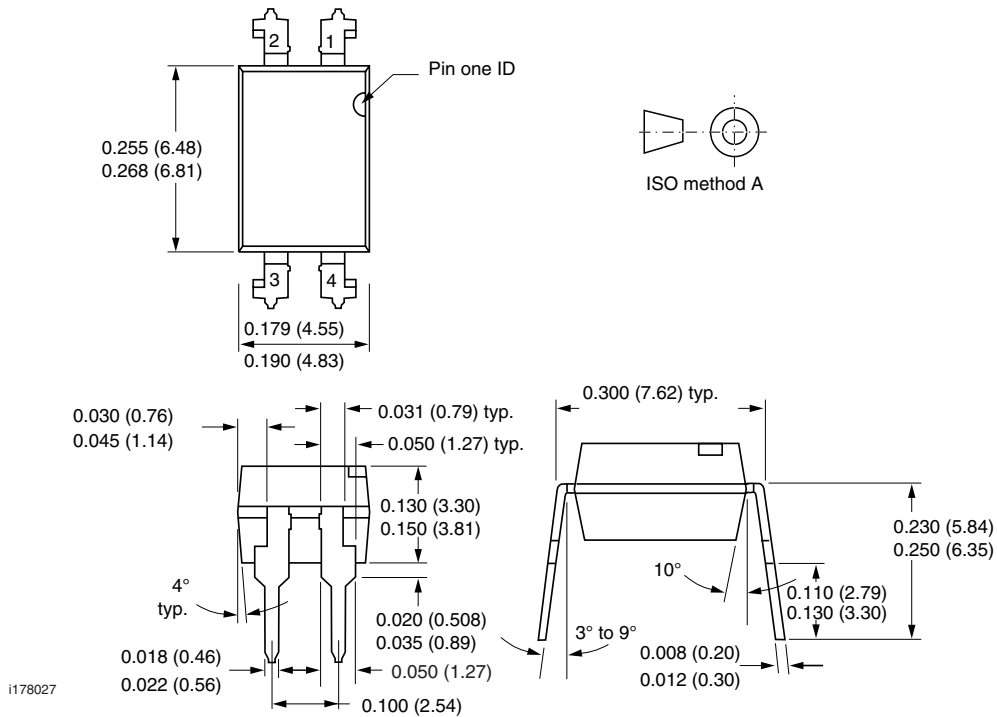

Fig. 11 - Forward Resistance vs. Forward Current

**PACKAGE DIMENSIONS** in inches (millimeters)

Rated

## **OZONE DEPLETING SUBSTANCES POLICY STATEMENT**

It is the policy of Vishay Semiconductor GmbH to

1. Meet all present and future national and international statutory requirements.
2. Regularly and continuously improve the performance of our products, processes, distribution and operating systems with respect to their impact on the health and safety of our employees and the public, as well as their impact on the environment.

It is particular concern to control or eliminate releases of those substances into the atmosphere which are known as ozone depleting substances (ODSs).

The Montreal Protocol (1987) and its London Amendments (1990) intend to severely restrict the use of ODSs and forbid their use within the next ten years. Various national and international initiatives are pressing for an earlier ban on these substances.

Vishay Semiconductor GmbH has been able to use its policy of continuous improvements to eliminate the use of ODSs listed in the following documents.

1. Annex A, B and list of transitional substances of the Montreal Protocol and the London Amendments respectively.
2. Class I and II ozone depleting substances in the Clean Air Act Amendments of 1990 by the Environmental Protection Agency (EPA) in the USA.
3. Council Decision 88/540/EEC and 91/690/EEC Annex A, B and C (transitional substances) respectively.

Vishay Semiconductor GmbH can certify that our semiconductors are not manufactured with ozone depleting substances and do not contain such substances.

We reserve the right to make changes to improve technical design  
and may do so without further notice.

Parameters can vary in different applications. All operating parameters must be validated for each customer application by the customer. Should the buyer use Vishay Semiconductors products for any unintended or unauthorized application, the buyer shall indemnify Vishay Semiconductors against all claims, costs, damages, and expenses, arising out of, directly or indirectly, any claim of personal damage, injury or death associated with such unintended or unauthorized use.

Vishay Semiconductor GmbH, P.O.B. 3535, D-74025 Heilbronn, Germany





## Disclaimer

All product specifications and data are subject to change without notice.

Vishay Intertechnology, Inc., its affiliates, agents, and employees, and all persons acting on its or their behalf (collectively, "Vishay"), disclaim any and all liability for any errors, inaccuracies or incompleteness contained herein or in any other disclosure relating to any product.

Vishay disclaims any and all liability arising out of the use or application of any product described herein or of any information provided herein to the maximum extent permitted by law. The product specifications do not expand or otherwise modify Vishay's terms and conditions of purchase, including but not limited to the warranty expressed therein, which apply to these products.

No license, express or implied, by estoppel or otherwise, to any intellectual property rights is granted by this document or by any conduct of Vishay.

The products shown herein are not designed for use in medical, life-saving, or life-sustaining applications unless otherwise expressly indicated. Customers using or selling Vishay products not expressly indicated for use in such applications do so entirely at their own risk and agree to fully indemnify Vishay for any damages arising or resulting from such use or sale. Please contact authorized Vishay personnel to obtain written terms and conditions regarding products designed for such applications.

Product names and markings noted herein may be trademarks of their respective owners.

Компания «Life Electronics» занимается поставками электронных компонентов импортного и отечественного производства от производителей и со складов крупных дистрибьюторов Европы, Америки и Азии.

С конца 2013 года компания активно расширяет линейку поставок компонентов по направлению коаксиальный кабель, кварцевые генераторы и конденсаторы (керамические, пленочные, электролитические), за счёт заключения дистрибьюторских договоров

Мы предлагаем:

- Конкуренспособные цены и скидки постоянным клиентам.
- Специальные условия для постоянных клиентов.
- Подбор аналогов.
- Поставку компонентов в любых объемах, удовлетворяющих вашим потребностям.
- Приемлемые сроки поставки, возможна ускоренная поставка.
- Доставку товара в любую точку России и стран СНГ.
- Комплексную поставку.
- Работу по проектам и поставку образцов.
- Формирование склада под заказчика.
- Сертификаты соответствия на поставляемую продукцию (по желанию клиента).
- Тестирование поставляемой продукции.
- Поставку компонентов, требующих военную и космическую приемку.
- Входной контроль качества.
- Наличие сертификата ISO.

В составе нашей компании организован Конструкторский отдел, призванный помогать разработчикам, и инженерам.

Конструкторский отдел помогает осуществить:

- Регистрацию проекта у производителя компонентов.
- Техническую поддержку проекта.
- Защиту от снятия компонента с производства.
- Оценку стоимости проекта по компонентам.
- Изготовление тестовой платы монтаж и пусконаладочные работы.



Тел: +7 (812) 336 43 04 (многоканальный)

Email: [org@lifeelectronics.ru](mailto:org@lifeelectronics.ru)