

P1 Relay V23026

- Directly triggerable with TTL standard modules as ALS, HCT & ACT
- Slim line 13.5x7.85mm (0.531x0.309")
- Switching current 1 A
- Bifurcated 1 form C (CO) contact
- Immersion cleanable
- High sensitivity results in low nominal power consumption, 65 to 130mW for monostable and 30 to 150mW for bistable (latching)
- Initial surge withstand voltage
2.5kV (2/10µs) meets the Bellcore Requirement GR-1089
1.5kV (10/160µs) meets FCC Part 68

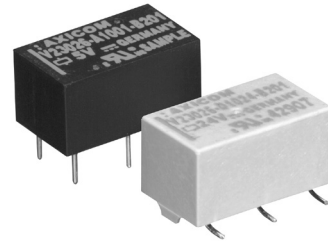

P1_THTSMD



Typical applications

Automotive equipment, CAN bus, immobilizer, office equipment, measurement and control equipment, medical equipment, safety equipment

Approvals

UL 508 File No. E 111441
Technical data of approved types on request

Contact Data

Contact arrangement	1 form C (CO)
Max. switching voltage	125VDC, 150VAC
Rated current	1A
Limiting continuous current, 85°C	1A
Breaking capacity max.	see max. DC load breaking capacity
Contact material	Palladium nickel, gold-rhodium covered bifurcated contact
Contact style	bifurcated contact
Min. recommended contact load	10mA at 20mV
Initial contact resistance	≤50mΩ at 10mA/20mV
Frequency of operation without load	200 ops./s
Operate/release time max.	2ms
Set/reset time max.	2ms
Bounce time max.	3ms
Electrical endurance	
at 12V/10mA	typ. 50x10 ⁶ operations
at 6V/100mA	typ. 10x10 ⁶ operations
at 30V/1000mA	typ. 10x10 ³ operations
Contact ratings	
UL contact ratings, resistive load	30VDC/1A 65VDC/0.46A 150VAC/0.46A
Mechanical endurance	typ. 10 ⁹ operations

Max. DC load breaking capacity

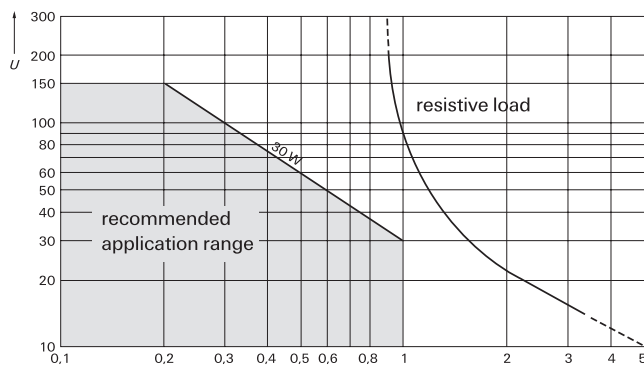

Coil Data

Magnetic system	polarized
Coil voltage range	3 to 24VDC other coil voltages on request
Operative range, IEC 61810	see coil operative range
Max. coil temperature	85°C
Thermal resistance	<130K/W

Coil versions, THT, monostable

Coil code	Rated voltage VDC	Operate voltage VDC _{min.}	Release voltage VDC _{min.}	Coil resistance Ω ±10%	Rated coil power mW
006	3	2.25	0.3	137	66
001	5	3.75	0.5	370	68
005	9	6.75	0.9	1165	70
002	12	9.00	1.2	2250	34
004	24	18.00	2.4	4500	128

All figures are given for coil without pre-energization, at ambient temperature +23°C.

Coil versions, SMT, monostable

Coil code	Rated voltage VDC	Operate voltage VDC _{min.}	Release voltage VDC _{min.}	Coil resistance Ω ±10%	Rated coil power mW
026	3	2.25	0.3	113	80
021	5	3.75	0.5	313	80
025	9	6.75	0.9	1015	80
022	12	9.00	1.2	1800	80
024	24	18.00	2.4	4500	128

All figures are given for coil without pre-energization, at ambient temperature +23°C.

Coil operative range, monostable DC coil

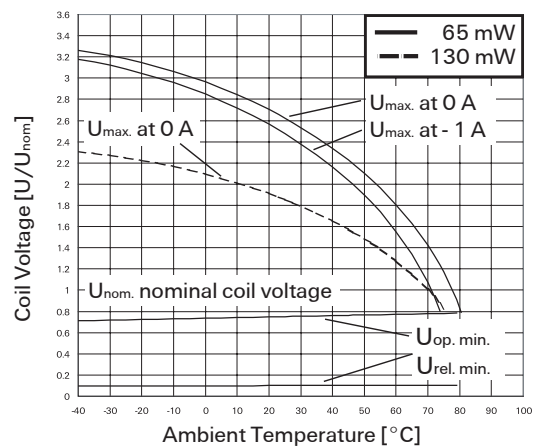

P1 Relay V23026 (Continued)

Coil data (continued)

Coil versions, THT and SMT, bistable 2 coils

Coil code	Rated voltage VDC	Set voltage VDC	Reset voltage VDC	Coil resistance $\Omega \pm 10\%$	Rated coil power mW
106	3	2.25	2.25	130	69
101	5	3.75	3.75	390	64
105	9	6.75	6.75	1200	68
102	12	9.00	9.00	1500	96

All figures are given for coil without pre-energization, at ambient temperature +23°C. Coils I and II are identical.

¹⁾ A nominal voltage of 24VDC is feasible with a 12VDC coil with a series resistor (1500 Ω)

Coil data (continued)

Coil versions, THT, bistable 1 coil

Coil code	Rated voltage VDC	Set voltage VDC	Reset voltage VDC	Coil resistance $\Omega \pm 10\%$	Rated coil power mW
056	3	2.25	-2.25	300	30
051	5	3.75	-3.75	740	34
057	9	6.75	-6.75	2160	38
052	12	9.00	-9.00	4500	32
054	24	18.00	-18.00	4500	128

Coil data (continued)

Coil versions, SMT, bistable 1 coil

Coil code	Rated voltage VDC	Set voltage VDC	Reset voltage VDC	Coil resistance $\Omega \pm 10\%$	Rated coil power mW
051	5	3.75	-3.75	740	34
052	12	9.00	-9.00	4500	32

A nominal voltage of 24V is feasible with a 12V coil with a series resistor (4500 Ω)

Other coil voltages on request

All figures are given for coil without pre-energization, at ambient temperature +23°C.

Coils I and II are identical.

Coil operative range, bistable

U_{max} upper limit of the operative range of the coil voltage (limiting voltage) when coils are

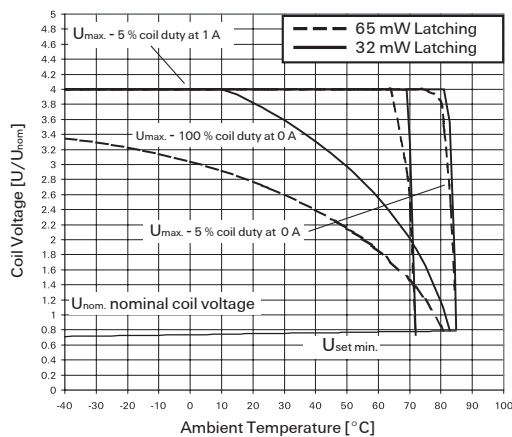

continuously energized.

$U_{op min}$ lower limit of the operative range of the coil voltage (reliable operate voltage).

$U_{rel min}$ lower limit of the operative range of the coil voltage (reliable release voltage).

Insulation Data

Initial dielectric strength	
between open contacts	500V _{rms}
between contact and coil	1500V _{rms}
Initial surge withstand voltage	
between contact and coil	2500V
Capacitance	
between open contacts	max. 5pF
between contact and coil	max. 6pF
Clearance/creepage	
between contact and coil	0.75mm
between adjacent contacts	0.75mm

RF Data

Isolation at 100MHz/900MHz	-30.0dB/-18.0dB
Insertion loss at 100MHz/900MHz	-0.12dB/-1.9dB
Voltage standing wave ratio (VSWR) at 100MHz/900MHz	1.06/1.75

Other Data

Material compliance: EU RoHS/ELV, China RoHS, REACH, Halogen content refer to the Product Compliance Support Center at www.te.com/customer-support/rohssupportcenter

Ambient temperature	-40 to +85°C
Category of environmental protection, IEC 61810	RT III - immersion cleanable
Vibration resistance (functional)	20g, 200 to 2000Hz 40g, 10 to 200Hz
Shock resistance (functional) IEC 60068-2-27 (half sine)	50 g
Terminal type	PCB terminals and SMT terminals
Weight	max. 2g
Resistance to soldering heat THT IEC 60068-2-20	265 °C/10s
Resistance to soldering heat SMT IEC 60068-2-58	see reflow profile
Moisture sensitive level, JEDEC J-Std-020D	MSL3
Washing	not recommended
Ultrasonic cleaning	possible
Packaging unit	
THT	2000 pcs.
SMT	2400 pcs.

P1 Relay V23026 (Continued)

Dimensions

THT version

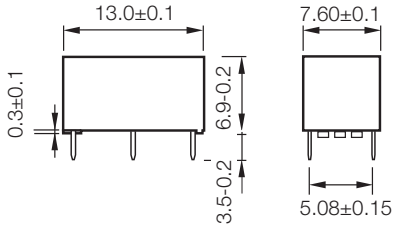

SMT version

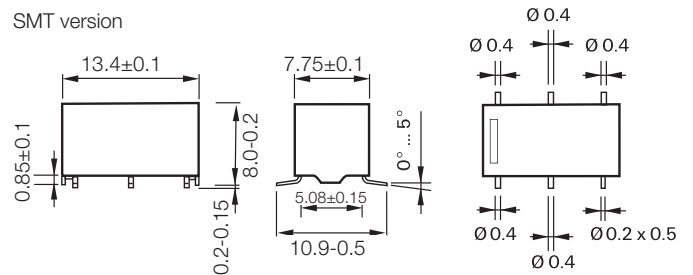

PCB layout

TOP view on component side of PCB

THT version

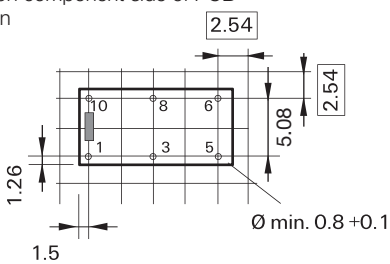

SMT version

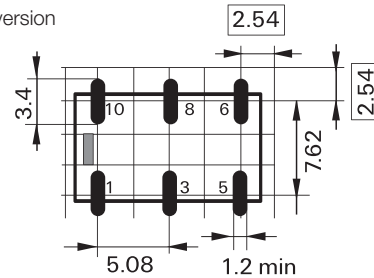

Terminal assignment

Monostable version
rest condition

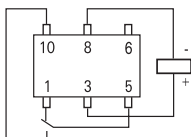

Bistable version, 1 coil
reset condition

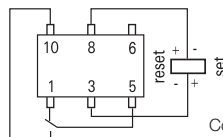

Bistable version, 2 coils
reset condition

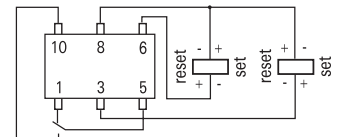

Contacts are shown in reset condition. Both coils can be used either as set or reset coil. Contact position might change during transportation and must be reset before use.

P1 Relay V23026 (Continued)

Processing

Recommended soldering conditions

Soldering conditions according IEC 60058-2-58 and IPC/JEDEC J-STD-020B

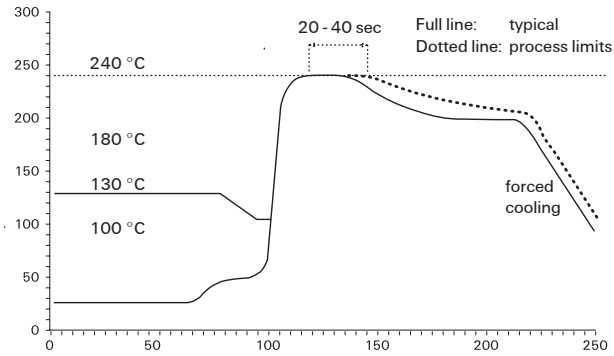

Resistance to soldering heat - Reflow profile
Vapor Phase Soldering: temperature/time profile (lead and housing peak temperature)

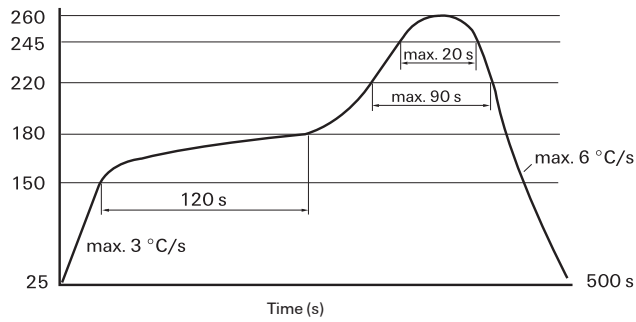

Infrared Soldering: temperature/time profile (lead and housing peak temperature)

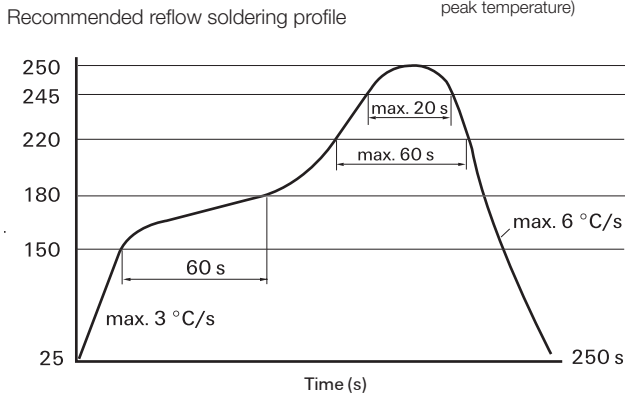

Packing

Tube for THT version
40 relays per tube, 2000 relays per box

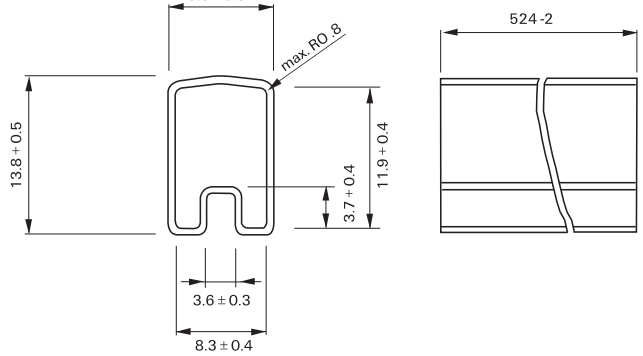

Tape and reel for SMT version
480 relays per reel, 2400 relays per box

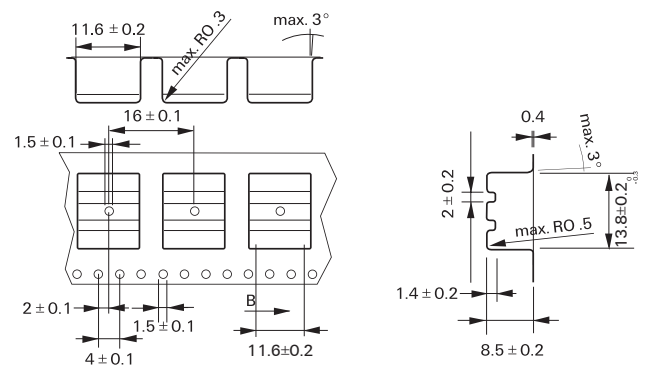

Reel dimensions

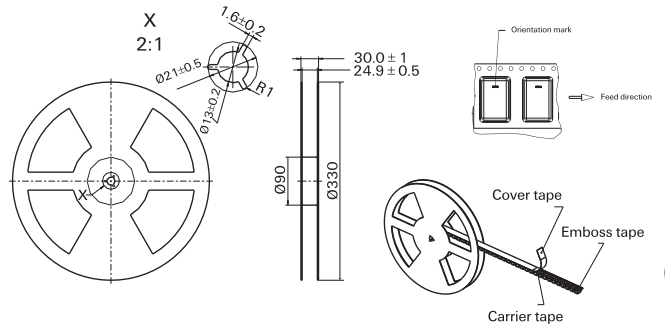

P1 Relay V23026 (Continued)

Product code structure		Typical product code	V23026	A1	002	B201
Type		V23026 P1 Series Signal Relay				
Version		A1 THT, monostable D1 SMT, monostable B1 THT, bistable (latching), 2 coils E1 SMT, bistable (latching), 2 coils C1 THT, bistable (latching), 1 coil F1 SMT, bistable (latching), 1 coil				
Coil		Coil code: please refer to coil versions table				
Contacts		B201 1 form C, 1 CO				

Product Code	Version	Coil	Coil voltage	Part Number
V23026A1006B201	THT version	monostable	3VDC	1-1393774-7
V23026A1001B201			5VDC	1393774-1
V23026A1005B201			9VDC	1-1393774-5
V23026A1002B201			12VDC	1393774-8
V23026A1004B201			24VDC	1-1393774-2
V23026B1106B201		bistable, 2 coils	3VDC	1393775-3
V23026B1101B201			5VDC	3-1393774-4
V23026B1105B201			9VDC	1393775-2
V23026B1102B201			12VDC	3-1393774-5
V23026C1056B201			3VDC	2-1393774-6
V23026C1051B201	5VDC		2-1393774-0	
V23026C1057B201	9VDC		2-1393774-7	
V23026C1052B201	12VDC		2-1393774-1	
V23026C1054B201	24VDC		2-1393774-4	
V23026D1026B201	SMT version		monostable	3VDC
V23026D1021B201		5VDC		1393776-3
V23026D1025B201		9VDC		1422015-9
V23026D1022B201		12VDC		1393776-4
V23026D1024B201		24VDC		1393776-7
V23026E1106B201		bistable, 2 coils	3VDC	1393777-3
V23026E1101B201			5VDC	1422015-6
V23026E1105B201			9VDC	1393777-2
V23026E1102B201			12VDC	1393776-9
V23026F1051B201			9VDC	1422015-8
V23026F1052B201	12VDC		4-1393774-3	

Компания «Life Electronics» занимается поставками электронных компонентов импортного и отечественного производства от производителей и со складов крупных дистрибьюторов Европы, Америки и Азии.

С конца 2013 года компания активно расширяет линейку поставок компонентов по направлению коаксиальный кабель, кварцевые генераторы и конденсаторы (керамические, пленочные, электролитические), за счёт заключения дистрибьюторских договоров

Мы предлагаем:

- Конкурентоспособные цены и скидки постоянным клиентам.
- Специальные условия для постоянных клиентов.
- Подбор аналогов.
- Поставку компонентов в любых объемах, удовлетворяющих вашим потребностям.
- Приемлемые сроки поставки, возможна ускоренная поставка.
- Доставку товара в любую точку России и стран СНГ.
- Комплексную поставку.
- Работу по проектам и поставку образцов.
- Формирование склада под заказчика.
- Сертификаты соответствия на поставляемую продукцию (по желанию клиента).
- Тестирование поставляемой продукции.
- Поставку компонентов, требующих военную и космическую приемку.
- Входной контроль качества.
- Наличие сертификата ISO.

В составе нашей компании организован Конструкторский отдел, призванный помогать разработчикам, и инженерам.

Конструкторский отдел помогает осуществить:

- Регистрацию проекта у производителя компонентов.
- Техническую поддержку проекта.
- Защиту от снятия компонента с производства.
- Оценку стоимости проекта по компонентам.
- Изготовление тестовой платы монтаж и пусконаладочные работы.



Тел: +7 (812) 336 43 04 (многоканальный)

Email: org@lifeelectronics.ru