

LUXEON Rebel and
LUXEON Rebel ES
Color Portfolio

*Illuminating
your creativity*

Technical Datasheet DS68

LUXEON
NEVER BEFORE POSSIBLE



LUXEON[®] Rebel and LUXEON[®] Rebel ES Color Portfolio

Introduction

With leading light output, color stability, flux density, and clear saturated colors, the LUXEON[®] Rebel Color Portfolio of emitters is ideal for a wide variety of lighting, signaling, signage and entertainment applications. Every LUXEON Rebel Color Portfolio emitter has built-in quality, reliability, lumen maintenance and the ease of manufacturing needed to create a superior high quality light.

Using the information in this document you can begin designing applications to your unique specifications.

Use LUXEON Rebel Color Portfolio to

- deliver more usable light and higher flux density
- optimize applications to reduce size and cost
- tightly pack the LEDs for color mixing
- engineer more robust applications
- utilize standard FR4 PCB technology
- simplify manufacturing through the use of surface mount technology
- recognized under the Component Recognition Program of Underwriters Laboratories Inc. UL listing E327436.

PHILIPS
LUMILEDS

Table of Contents

General Product Information	3
Product Nomenclature.....	3
Average Lumen Maintenance Characteristics	3
Environmental Compliance.....	3
Flux and Efficacy Performance Characteristics	4
Flux Performance, Binning, and Supportability	5
Optical Characteristics	6
Electrical Characteristics.....	7
Absolute Maximum Ratings	8
JEDEC Moisture Sensitivity.....	8
Reflow Soldering Characteristics	9
Mechanical Dimensions: LUXEON Rebel Color Emitter	10
Mechanical Dimensions: LUXEON Rebel ES Royal-Blue Emitter	11
Pad Configuration	12
Solder Pad Design.....	12
Wavelength Characteristics.....	13
Typical Light Output Characteristics over Temperature.....	14
Typical Forward Current Characteristics	15
Typical Relative Luminous Flux	16
Current Derating Curves.....	18
Typical Radiation Patterns	21
Typical Radiation Patterns	24
Typical Chromaticity Characteristics PC Amber	25
Emitter Pocket Tape Packaging.....	26
Emitter Reel Packaging	27
Product Binning and Labeling	28
Luminous Flux Bins.....	29
Forward Voltage Bins.....	30
Color Bins.....	31
Color Bins PC Amber	33

General Product Information

Product Nomenclature

LUXEON Rebel color emitters are tested and binned at 350 mA with the exception of LUXEON Rebel ES royal-blue emitters which are tested and binned at 700 mA.

The part number designation is explained as follows:

L X M L - A B C D - E F G H

L X M 2 - A B C D - E F G H

L X M 3 - A B C D - E F G H

Where:

A — designates radiation pattern (value P for lambertian)

B — designates color (see LUXEON Rebel color binning and labeling section)

C — designates color variant (0 for color variants)

D — designates test current (value 1 for 350 mA; 2 for 700 mA.)

E — reserved for future product offerings

FGH — minimum luminous flux (lm) or radiometric power (mW) performance

Therefore products tested and binned at 350 mA or 700 mA follow the part numbering scheme:

L X M L - P x 0 1 - x x x x

L X M L - P x 0 2 - x x x x

L X M 2 - P x 0 1 - x x x x

L X M 3 - P x 0 1 - x x x x

Average Lumen Maintenance Characteristics

LUXEON Rebel color emitters are tested and binned at 350 mA and LUXEON Rebel ES royal-blue at 700 mA, with current pulse duration of 20 ms. All characteristic charts where the thermal pad is kept at constant temperature (25°C typically) are measured with current pulse duration of 20 ms. Under these conditions, junction temperature and thermal pad temperature are the same.

Philips Lumileds projects that green, cyan, blue and all royal-blue LUXEON Rebel color products will deliver, on average, 70% lumen maintenance (B50, L70) at 50,000 hours of operation at a forward current of 700 mA. This projection is based on constant current operation with junction temperature maintained at or below 135°C. Red, red-orange and amber LUXEON Rebel color products will also deliver, on average, 70% lumen maintenance (B50, L70) at 50,000 hours of operation at a forward current of 350 mA and is based on constant current operation with junction temperature maintained at or below 110°C. LUXEON Rebel PC amber delivers, on average, 70% lumen maintenance (L70) at 50,000 hours of operation at a forward current of up to 700 mA. This projection is based on constant current operation with junction temperature maintained at or below 130°C.

This performance is based on independent test data, Philips Lumileds historical data from tests run on similar material systems, and internal LUXEON Rebel reliability testing. Observation of design limits included in this data sheet is required in order to achieve this projected lumen maintenance.

Environmental Compliance

Philips Lumileds is committed to providing environmentally friendly products to the solid-state lighting market. LUXEON Rebel and LUXEON Rebel ES color products are compliant to the European Union directives on the restriction of hazardous substances in electronic equipment, namely REACH and the RoHS directive. Philips Lumileds will not intentionally add the following restricted materials to the LUXEON Rebel Color Portfolio: lead, mercury, cadmium, hexavalent chromium, polybrominated biphenyls (PBB) or polybrominated diphenyl ethers (PBDE).

Flux and Efficacy Performance Characteristics

Luminous Flux Characteristics for LUXEON Rebel Color Portfolio, Thermal Pad Temperature =25°C

Table I.

Color	Part Number	Performance @ 350 mA			Performance @ 700 mA		
		Min Luminous Flux (lm) or Radiometric Power (mW)	Typ Flux	Typ Efficacy (lm/W) or Radiant Efficacy for Royal-Blue and Deep Red	Min Luminous Flux (lm) or Radiometric Power (mW)	Typ Luminous Flux (lm) or Radiometric Power (mW)	Typ Efficacy (lm/W) or Radiant Efficacy for Royal-Blue and Deep Red
Green	LXML-PM01-0100	100	102	100		161	68
	LXML-PM01-0090	90	95	93		150	63
	LXML-PM01-0080	80	88	86		139	58
	LXML-PM01-0070	70	79	78		125	52
Cyan	LXML-PE01-0080	80	83	81		133	56
	LXML-PE01-0070	70	76	75		122	51
	LXML-PE01-0060	60	67	66		110	46
Blue	LXML-PB01-0040	40.0	41	38		70	29
	LXML-PB01-0030	30.0	35	33		58	24
	LXML-PB01-0023	23.5	28	26		48	20
	LXML-PB01-0018	18.1	22	21		38	16
Royal-Blue	LXML-PR01-0500	500 mW	520 mW	48%		910 mW	40%
	LXML-PR01-0425	425 mW	480 mW	44%		840 mW	37%
	LXML-PR02-1100*				1100 mW	1120 mW	53%
	LXML-PR02-1050*				1050 mW	1070 mW	51%
	LXML-PR02-1000*				1000 mW	1030 mW	49%
	LXML-PR02-0950*				950 mW	970 mW	46%
	LXML-PR02-0900*				900 mW	940 mW	44%
	LXML-PR02-0800*				800 mW	890 mW	42%
Deep Red	LXM3-PD01-0350	350 mW	360 mW	46%		720 mW	42%
	LXM3-PD01-0300	300 mW	320 mW	41%		640 mW	38%
	LXM3-PD01-0260	260 mW	290 mW	37%		580 mW	34%
Red	LXM2-PD01-0050	50	53	72		102	63
	LXM2-PD01-0040	40	48	65		90	56
	LXML-PD01-0050	50	52	53		85	35
	LXML-PD01-0040	40	46	47		75	30
	LXML-PD01-0030	30	38	37		62	24
Red-Orange	LXM2-PH01-0070	70	72	98		134	83
	LXM2-PH01-0060	60	67	91		122	76
	LXML-PH01-0060	60	62	63		100	40
	LXML-PH01-0050	50	56	57		90	35
PC Amber	LXM2-PL01-0090	90	91	85		164	73
	LXM2-PL01-0080	80	84	79		151	68
	LXM2-PL01-0070	70	78	73		140	63
	LXM2-PL01-0060	60	69	65		124	55
Amber	LXML-PL01-0060	60	61	60		98	39
	LXML-PL01-0050	50	54	51		84	33
	LXML-PL01-0040	40	48	46		77	30
	LXML-PL01-0030	30	38	37		61	24

* All LUXEON Rebel color emitters except royal-blue emitters are tested and binned for dominant wavelength. Royal-blue emitters are tested and binned using peak wavelength. LUXEON Rebel ES royal-blue emitters are tested and binned at 700 mA.

Luminous Flux Characteristics for LUXEON Rebel Color Portfolio, Continued

Notes for Table 1:

1. Minimum luminous flux or radiometric power performance guaranteed within published operating conditions. Philips Lumileds maintains a tolerance of $\pm 6.5\%$ on flux and power measurements.
2. Typical luminous flux or radiometric power performance when device is operated within published operating conditions.

Flux Performance, Binning, and Supportability

LEDs are produced with semiconductor technology that is subject to process variation, yielding a range of flux performance that is approximately Gaussian in nature. In order to provide customers with fine granularity within the overall flux distribution, Philips Lumileds separates LEDs into fixed, easy to design with, minimum luminous flux bins. To verify supportability of parts chosen for your application design, please consult your Philips Lumileds or Future Lighting Solutions sales representative.

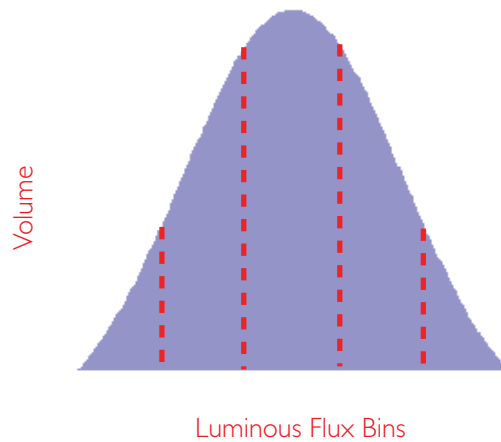

Optical Characteristics

LUXEON Rebel Color Portfolio at Test Current ^[1] Thermal Pad Temperature = 25°C

Table 2.

Color	Dominant Wavelength ^[2] λ_D , or Peak Wavelength ^[3] λ_P			Typical Spectral Half-width ^[4] (nm) $\Delta\lambda_{1/2}$	Typical Temperature Coefficient of Dominant Wavelength (nm/°C) $\Delta\lambda_D / \Delta T_J$	Typical Total Included Angle ^[5] (degrees) $\theta_{0.90V}$	Typical Viewing Angle ^[6] (degrees) $2\theta_{1/2}$
	Min.	Typ.	Max.				
Green ^[7]	520.0 nm	530.0 nm	550.0 nm	30	0.05	160	125
Cyan ^[7]	490.0 nm	505.0 nm	520.0 nm	30	0.04	160	125
Blue ^[7]	460.0 nm	470.0 nm	490.0 nm	20	0.05	160	125
Royal-Blue ^{[3] [7]}	440.0 nm	447.5 nm	460.0 nm	20	0.04	160	125
Red ^[8]	620.0 nm	627.0 nm	645.0 nm	20	0.05	160	125
Deep Red ^[8]	650.0 nm	655.0 nm	670.0 nm	20	0.05	160	125
Red-Orange ^[8]	610.0 nm	617.0 nm	620.0 nm	20	0.08	160	125
Amber ^[8]	584.5 nm	590.0 nm	597.0 nm	20	0.10	160	125
PC Amber ^[7]	588.0 nm	591.0 nm	592.0 nm	80	0.10	160	120

Notes for Table 2:

1. LXML-PR01-XXXX, LXM2-PL01-XXXX and LXM3-PD01-XXXX emitters are tested at 350 mA, LXML-PR02-XXXX emitters are tested at 700 mA.
2. Dominant wavelength is derived from the CIE 1931 Chromaticity diagram and represents the perceived color. Philips Lumileds maintains a tolerance of ± 0.5 nm for dominant wavelength measurements.
3. Royal-blue product is binned by radiometric power and peak wavelength rather than photometric lumens. Philips Lumileds maintains a tolerance of ± 2 nm for peak wavelength measurements.
4. Spectral width at $1/2$ of the peak intensity.
5. Total angle at which 90% of total luminous flux is captured.
6. Viewing angle is the off axis angle from lamp centerline where the luminous intensity is $1/2$ of the peak value.
7. PC amber, green, cyan, blue and royal-blue products are built with Indium Gallium Nitride (InGaN).
8. All red, deep red, red-orange, and amber are built with Aluminum Indium Gallium Phosphide (AlInGaP).

Electrical Characteristics

Electrical Characteristics at 350 mA for LUXEON Rebel color, Thermal Pad Temperature = 25°C

Table 3.

Color	Part Number	Forward Voltage V_f [1]			Typical Temperature Coefficient of Forward Voltage [2] (mV/°C) $\Delta V_f / \Delta T_j$	Typical Thermal Resistance Junction to Thermal Pad (°C/W) $R\theta_{j-c}$
		Min.	Typ.	Max.		
Green	LXML-PM01	2.55	2.90	3.51	- 2.0 to - 4.0	10
Cyan	LXML-PE01	2.55	2.90	3.51	- 2.0 to - 4.0	10
Blue	LXML-PB01	2.55	3.03	3.51	- 2.0 to - 4.0	10
Royal-Blue	LXML-PR01	2.55	3.03	3.51	- 2.0 to - 4.0	10
Red	LXML-PD01	2.31	2.90	3.51	- 2.0 to - 4.0	12
Red	LXM2-PD01	1.80	2.10	2.80	- 2.0 to - 4.0	8
Deep Red	LXM3-PD01	1.80	2.20	2.80	- 2.0 to - 4.0	8
Red-Orange	LXML-PH01	2.31	2.90	3.51	- 2.0 to - 4.0	12
Red-Orange	LXM2-PH01	1.80	2.10	2.80	- 2.0 to - 4.0	8
PC Amber	LXM2-PL01	2.55	3.05	3.51	- 2.0 to - 4.0	10
Amber	LXML-PH01	2.31	2.90	3.51	- 2.0 to - 4.0	12

Electrical Characteristics at 700 mA for LUXEON Rebel ES Royal-Blue, Thermal Pad Temperature = 25°C

Royal-Blue	LXML-PR02	2.50	3.00	3.50	- 2.0 to - 4.0	6
------------	-----------	------	------	------	----------------	---

Notes for Table 3:

1. LUXEON Rebel ES royal-blue measured between 25°C = T_j = 110°C and I_f = 700 mA.
2. Measured between 25°C = T_j = 110°C at I_f = 350 mA.
3. Philips Lumileds maintains a tolerance of ±0.06V on forward voltage measurements.

Typical Electrical Characteristics at 700 mA for LUXEON Rebel color, Thermal Pad Temperature = 25°C

Table 4.

Color	Part Number	Typical Forward Voltage V_f (V)
Green	LXML-PM01	3.25
Cyan	LXML-PE01	3.25
Blue	LXML-PB01	3.30
Royal-Blue	LXML-PR02	3.00
Royal-Blue	LXML-PR01	3.25
Red	LXML-PD01	3.60
Red	LXM2-PD01	2.30
Deep Red	LXM3-PD01	2.40
Red-Orange	LXML-PH01	3.60
Red-Orange	LXM2-PH01	2.30
PC Amber	LXM2-PL01	3.20
Amber	LXML-PH01	3.60

Absolute Maximum Ratings

Table 5.

Parameter	Green/Cyan/ Blue/Royal-Blue	LUXEON Rebel ES Royal-Blue	Red/Deep-Red Red-Orange/Amber	PC Amber
DC Forward Current (mA)	1000	1000	700	700
Peak Pulsed Forward Current (mA)	1000	1200	700	700
Average Forward Current (mA)	1000	1000	700	700
ESD Sensitivity	< 8000V Human Body Model (HBM) Class 3A JESD22-A114-B			
LED Junction Temperature ^[1]	150°C	150°C	135°C	130°C
Operating Case Temperature at 350 mA	-40°C - 135°C	-40°C - 135°C	-40°C - 120°C	-40°C - 110°C
Storage Temperature	-40°C - 135°C	-40°C - 135°C	-40°C - 135°C	-40°C - 135°C
Soldering Temperature	JEDEC 020c 260°C	JEDEC 020c 260°C	JEDEC 020c 260°C	JEDEC 020c 260°C
Allowable Reflow Cycles	3	3	3	3
Reverse Voltage (Vr)	Autoclave Conditions 121°C at 2 ATM 100% Relative Humidity for 96 Hours Maximum LUXEON Rebel Color Portfolio LEDs are not designed to be driven in reverse bias.			

Notes for Table 5:

1. Proper current derating must be observed to maintain junction temperature below the maximum.
2. The maximum rating for LUXEON Rebel ES royal-blue is 1200 mA with peak pulsed forward current not to exceed 60 seconds.

JEDEC Moisture Sensitivity

Table 6.

Level	Floor Life		Soak Requirements	
	Time	Conditions	Standard	
			Time (hours)	Conditions
I	unlimited	≤ 30°C / 85% RH	168 + 5 / -0	85°C / 85% RH

Reflow Soldering Characteristics



Table 7.

Profile Feature	Lead Free Assembly
Average Ramp-Up Rate ($T_{S_{max}}$ to T_p)	3°C / second max
Preheat Temperature Min ($T_{S_{min}}$)	150°C
Preheat Temperature Max ($T_{S_{max}}$)	200°C
Preheat Time ($t_{s_{min}}$ to $t_{s_{max}}$)	60 - 180 seconds
Temperature T_L (t_L)	217°C
Time Maintained Above Temperature T_L (t_L)	60 - 150 seconds
Peak / Classification Temperature (T_p)	260°C
Time Within 5°C of Actual Peak Temperature (t_p)	20 - 40 seconds
Ramp-Down Rate	6°C / second max
Time 25°C to Peak Temperature	8 minutes max

Note for Table 7:

- All temperatures refer to the application Printed Circuit Board (PCB), measured on the surface adjacent to the package body.

Mechanical Dimensions: LUXEON Rebel Color Emitter



Figure 1. Package outline drawing.

Notes for Figure 1:

- To avoid damage, do not handle the device by the emitter lens.
- Drawings not to scale.
- All dimensions are in millimeters.
- The thermal pad is electrically isolated from the anode and cathode contact pads.

Mechanical Dimensions: LUXEON Rebel ES Royal-Blue Emitter

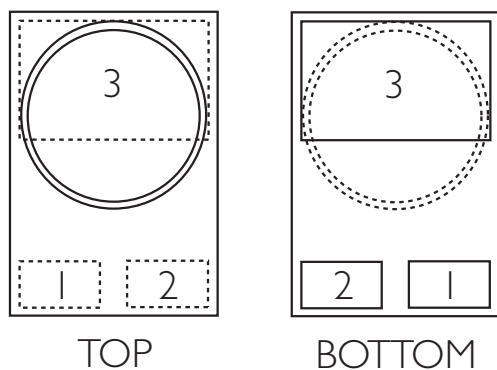

Figure 2. Package outline drawing.

Notes for Figure 2:

- To avoid damage, do not handle the device by the emitter lens.
- Drawings not to scale.
- All dimensions are in millimeters.
- The thermal pad is electrically isolated from the anode and cathode contact pads.

Pad Configuration



PAD	FUNCTION
1	CATHODE
2	ANODE
3	THERMAL

Figure 3. Pad configuration.

Note for Figure 3:

- The thermal pad is electrically isolated from the anode and cathode contact pads.

Solder Pad Design

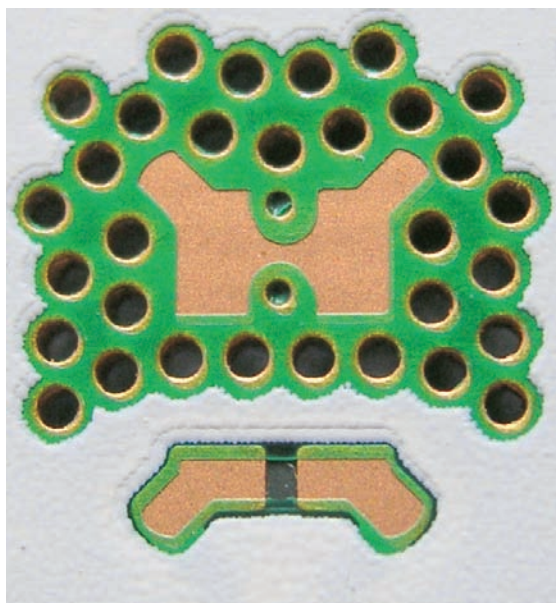

Figure 4. Solder pad layout.

Notes for Figure 4:

- The photograph shows the recommended LUXEON Rebel Color Portfolio layout on printed circuit board (PCB). This design easily achieves a thermal resistance of 7K/W.
- Application Brief AB32 provides extensive details for this layout. The .dwg files are available at www.philipslumileds.com and www.philipslumileds.cn.com.

Wavelength Characteristics

Green, Cyan, Blue, all Royal-Blue, Red, Red-Orange and Amber at Test Current, Thermal Pad Temperature = 25°C



Figure 5. Relative intensity vs. wavelength.

PC Amber at Test Current, Thermal Pad Temperature = 25°C



Figure 6. Relative intensity vs. wavelength.

Typical Light Output Characteristics over Temperature

Cyan, Blue and Royal-Blue and LUXEON Rebel ES Royal-Blue at Test Current



*LXML-PR02 values are based on 700 mA drive current.

Figure 7. Relative light output vs. thermal pad temperature for cyan, blue, royal-blue and LUXEON Rebel ES royal-blue.

Red, Deep Red, Red-Orange and Amber at Test Current



Figure 8. Relative light output vs. thermal pad temperature for red, deep red, red-orange and amber.

Typical Forward Current Characteristics

Green, Cyan, Blue, Royal-Blue and LUXEON Rebel ES Royal-Blue Thermal Pad Temperature = 25°C



Figure 9. Forward current vs. forward voltage for green, cyan, blue and royal-blue.

Red, Deep Red, Red-Orange, Amber and PC Amber Thermal Pad Temperature = 25°C



Figure 10. Forward current vs. forward voltage for red, deep red, red-orange, amber, and PC amber.

Typical Relative Luminous Flux

Typical Relative Luminous Flux vs. Forward Current for LUXEON Rebel ES Royal-Blue, Thermal Pad Temperature = 25°C



Figure 11. Relative luminous flux or radiometric power vs. forward current for LUXEON Rebel ES royal-blue at Thermal Pad = 25°C maintained.

Typical Relative Luminous Flux vs. Forward Current for Green, Cyan, Blue and Royal-Blue, Thermal Pad Temperature = 25°C



Figure 12. Relative luminous flux or radiometric power vs. forward current for green, cyan, blue and royal-blue at Thermal Pad = 25°C maintained.

Typical Relative Luminous Flux vs. Forward Current for Red, Deep Red, Red-Orange, Amber, Thermal Pad Temperature = 25°C



Figure 13. Relative luminous flux vs. forward current for red, deep red, red-orange and amber at Thermal Pad = 25°C maintained.

Typical Relative Luminous Flux, PC Amber Thermal Pad Temperature = 25°C



Figure 14. Relative luminous flux vs. forward current for PC amber LXML-PL02 emitters.

Current Derating Curves

Current Derating Curve for 350 mA Drive Current for Green, Cyan, Blue and Royal-Blue



Figure 15. Maximum forward current vs. ambient temperature, based on $T_{JMAX} = 150^{\circ}C$, green LXML-PM01, cyan LXML-PE01, blue LXML-PB01 & royal-blue LXML-PR01 emitters.

Current Derating Curve for 350 mA Drive Current for Red, Red-Orange, Amber



Figure 16. Maximum forward current vs. ambient temperature, based on $T_{JMAX} = 135^{\circ}C$, red LXML-PD01, red-orange LXML-PH01 & amber LXML-PL01 emitters.

Current Derating Curve for 350 mA Drive Current for Red, Deep-Red and Red-Orange



Figure 17. Maximum forward current vs. ambient temperature, based on $T_{JMAX} = 135^{\circ}C$, red LXM2-PD01, deep red LXM3-PD01 & red-orange LXM2-PH01 emitters.

Current Derating Curve for 350 mA Drive Current for PC Amber

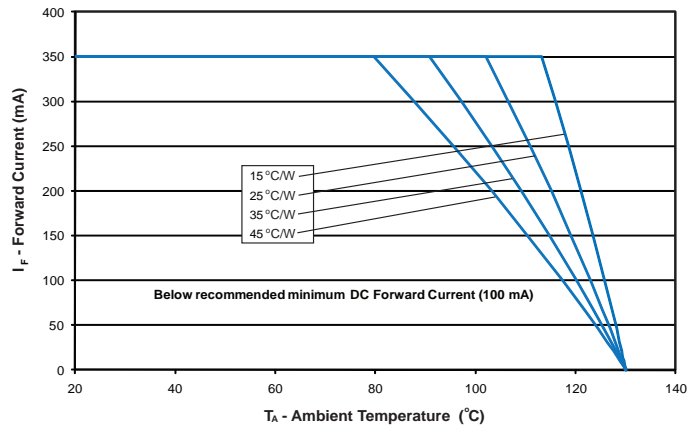

Figure 18. Maximum forward current vs. ambient temperature, based on $T_{JMAX} = 130^{\circ}C$, PC amber LXM2-PL01 emitters.

Current Derating Curves

Current Derating Curve for 700 mA Drive Current for Green, Cyan, Blue and Royal-Blue



Figure 19. Maximum forward current vs. ambient temperature, based on $T_{JMAX} = 150^{\circ}\text{C}$, green LXML-PM01, cyan LXML-PE01, blue LXML-PB01 & royal-blue LXML-PR01 emitters..

Current Derating Curve for 700 mA Drive Current for LUXEON Rebel ES Royal-Blue



Figure 20. Maximum forward current vs. ambient temperature, based on $T_{JMAX} = 150^{\circ}\text{C}$, royal-blue LXML-PR02 emitters.

Current Derating Curve for 700 mA Drive Current for Red, Red-Orange, Amber

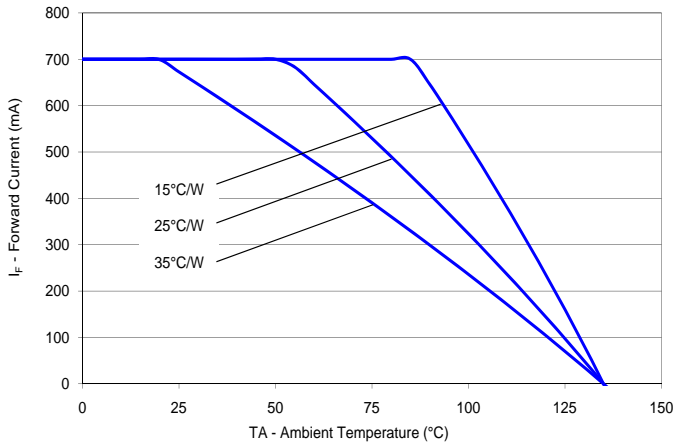

Figure 21. Maximum forward current vs. ambient temperature, based on $T_{JMAX} = 135^{\circ}\text{C}$, red LXML-PD01, red-orange LXML-PH01 & amber LXML-PL01 emitters.

Current Derating Curve for 700 mA Drive Current for Red, Deep Red and Red-Orange



Figure 22. Maximum forward current vs. ambient temperature, based on $T_{JMAX} = 135^{\circ}\text{C}$, red LXM2-PD01, deep red LXM3-PD01 & red-orange LXM2-PH01 emitters.

Current Derating Curves

Current Derating Curve for 700 mA Drive Current for PC Amber



Figure 23. Maximum forward current vs. ambient temperature, based on $T_{JMAX} = 130^{\circ}\text{C}$, PC amber LXM2-PL01 emitters.

Current Derating Curve for 1000 mA Drive Current for Green, Cyan, Blue and Royal-Blue

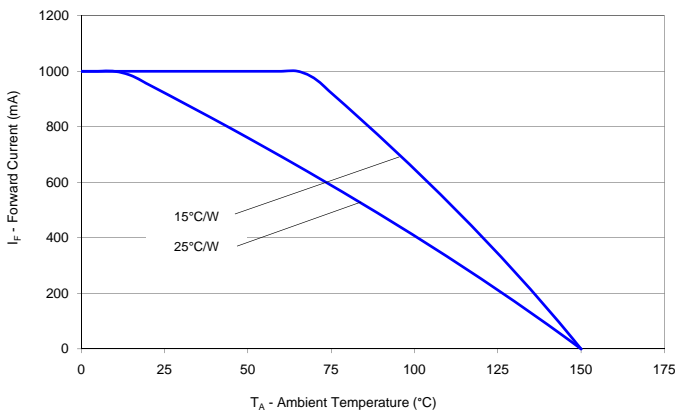

Figure 24. Maximum forward current vs. ambient temperature, based on $T_{JMAX} = 135^{\circ}\text{C}$, green LXML-PM01, cyan LXML-PE01, blue LXML-PB01 & royal-blue LXML-PR01.

Current Derating Curve for 1000 mA Drive Current for LUXEON Rebel ES Royal-Blue



Figure 25. Maximum forward current vs. ambient temperature, based on $T_{JMAX} = 150^{\circ}\text{C}$, royal-blue LXML-PR02 emitters.

Typical Radiation Patterns

Typical Spatial Radiation Pattern for Green, Cyan, Blue, Royal-Blue and LUXEON Rebel ES Royal-Blue Lambertian



Figure 26. Typical spatial radiation pattern for green, cyan, blue, royal-blue and LUXEON Rebel ES royal-blue lambertian.

Typical Polar Radiation Pattern for Green, Cyan, Blue, Royal-Blue and LUXEON Rebel ES Royal-Blue Lambertian



Figure 27. Typical polar radiation pattern for green, cyan, blue, royal-blue and LUXEON Rebel ES royal-blue lambertian.

Typical Spatial Radiation Pattern for Red, Red-Orange and Amber Lambertian



Figure 28. Typical spatial radiation pattern for red, red-orange and amber lambertian.

Typical Polar Radiation Pattern for Red, Red-Orange and Amber Lambertian



Figure 29. Typical polar radiation pattern for red, red-orange and amber lambertian.

Typical Spatial Radiation Pattern for Deep Red Lambertian



Figure 30. Typical spatial radiation pattern for deep red lambertian.

Typical Polar Radiation Pattern for Deep Red Lambertian

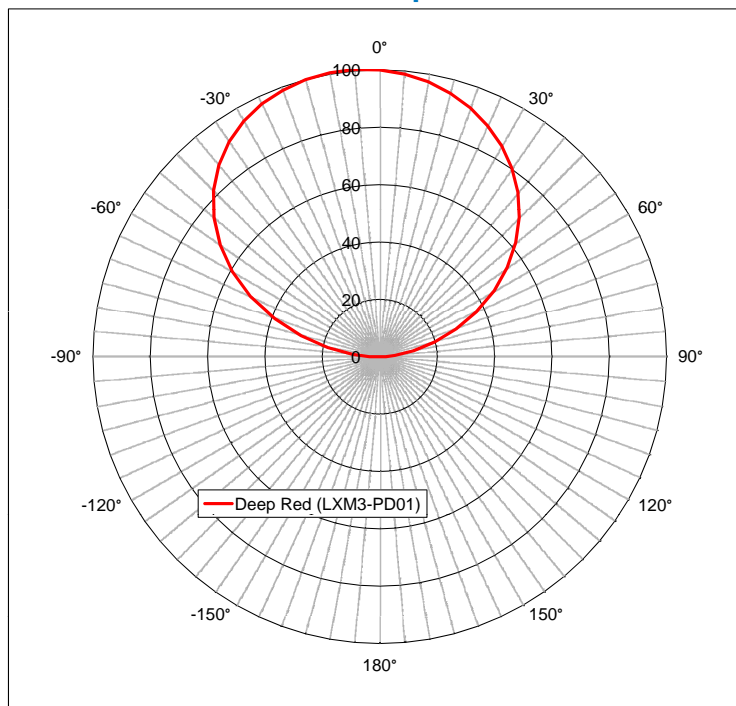

Figure 31. Typical polar radiation pattern for deep red lambertian.

Typical Radiation Patterns

Typical Spatial Radiation Pattern PC Amber



Figure 32. Typical representative spatial radiation pattern, PC amber LXM2-PL01 emitters.

Typical Polar Radiation Pattern PC Amber



Figure 33. Typical polar radiation pattern, PC amber LXM2-PL01 emitters.

Typical Chromaticity Characteristics PC Amber

Typical Chromaticity Characteristics over Temperature



Figure 34. Chromaticity coordinate vs. thermal pad temperature. Test current: 350 mA.

Typical Chromaticity Characteristics over Forward Current Thermal Pad Temperature = 25 °C



Figure 35. Chromaticity coordinate vs. forward current.

Emitter Pocket Tape Packaging



Figure 36. Emitter pocket tape packaging.

Emitter Reel Packaging



Figure 37. Emitter reel packaging.

Product Binning and Labeling

Purpose of Product Binning

In the manufacturing of semiconductor products, there is a variation of performance around the average values given in the technical data sheets. For this reason, Philips Lumileds bins the LED components for luminous flux, color and forward voltage (V_f).

Decoding Product Bin Labeling

LUXEON Rebel Color Portfolio emitters are labeled using a three or four digit alphanumeric code (CAT code) depicting the bin values for emitters packaged on a single reel. All emitters packaged within a reel are of the same 3-variable bin combination. Using these codes, it is possible to determine optimum mixing and matching of products for consistency in a given application.

Format of Labeling for Emitters

Reels of green, cyan, blue, royal-blue, red, red-orange, amber and PC amber emitters are labeled with a three digit alphanumeric CAT code following the format below.

ABC

A = Flux bin (J, K, L, M etc.)

B = Color bin (2, 4, 6 etc.)

C = V_f bin (D, E, F, G etc.)

Luminous Flux Bins

Tables 8, 9 and 10 list the standard photometric luminous flux/radiometric power bins for LUXEON Rebel and LUXEON Rebel ES color emitters (tested and binned at 350 mA and 700 mA respectively). Although several bins are outlined, product availability in a particular bin varies by production run and by product performance. Not all bins are available in all colors.

Table 8.

Flux Bins All Colors (except Royal-Blue)		
Bin Code	Minimum Flux (lm)	Maximum Flux (lm)
D	18.1	23.5
E	23.5	30
F	30	40
G	40	50
H	50	60
J	60	70
K	70	80
L	80	90
M	90	100
N	100	120
P	120	140
Q	140	160
R	160	180

Table 9.

LUXEON Rebel Royal-Blue and LUXEON Rebel ES Royal-Blue		
Bin Code	Minimum Radiometric Flux (mW)	Maximum Radiometric Flux (mW)
D	350	425
E	425	500
F	500	600
G	600	700
H	700	800
J	800	900
K	900	950
Y	950	1000
A	1000	1050
B	1050	1100
M	1100	1200

Table 10.

LUXEON Rebel Deep Red		
Bin Code	Minimum Radiometric Flux (mW)	Maximum Radiometric Flux (mW)
C	260	300
D	300	350
E	350	400

Forward Voltage Bins

The following forward voltage bins include the minimum and maximum V_f bin values for the emitter. Although several bins are outlined, product availability in a particular bin varies by production run and by product performance.

Table 11. Applicable for LXML-PXX1 emitters tested at 350 mA.

V_f Bins		
Bin Code	Minimum Forward Voltage (V)	Maximum Forward Voltage (V)
A	2.31	2.55
B	2.55	2.79
C	2.79	3.03
D	3.03	3.27
E	3.27	3.51

Table 12. Applicable for LXML-Pxx2 emitters tested at 700 mA.

Bin Code	Minimum Forward Voltage (V)	Maximum Forward Voltage (V)
P	2.50	2.75
R	2.75	3.00
S	3.00	3.25
T	3.25	3.50

Table 13. Applicable for LXM2-PXX1 and LXM3-PD01 (Deep Red) emitters tested at 350 mA.

Bin Code	Minimum Forward Voltage (V)	Maximum Forward Voltage (V)
V	1.80	2.00
W	2.00	2.20
X	2.20	2.40
Y	2.40	2.60
Z	2.60	2.80

Color Bins

Green, cyan and blue LUXEON Rebel color emitters are tested and binned for dominant wavelength.

Dominant Wavelength Bin Structure for Green Emitters

Table 14.

Bin Code	Minimum Dominant Wavelength (nm)	Maximum Dominant Wavelength (nm)
1	520	525
2	525	530
3	530	535
4	535	540
5	540	545
6	545	550

Dominant Wavelength Bin Structure for Cyan Emitters

Table 15.

Bin Code	Minimum Dominant Wavelength (nm)	Maximum Dominant Wavelength (nm)
1	490	495
2	495	500
3	500	505
4	505	510
5	510	515
6	515	520

Dominant Wavelength Bin Structure for Blue Emitters

Table 16.

Bin Code	Minimum Dominant Wavelength (nm)	Maximum Dominant Wavelength (nm)
1	460	465
2	465	470
3	470	475
4	475	480
5	480	485
6	485	490

Royal-blue LUXEON Rebel and LUXEON Rebel ES emitters are tested and binned for peak wavelength.

Peak Wavelength Bin Structure for Royal-Blue and LUXEON Rebel ES Royal-Blue Emitters

Table 17.

Bin Code	Minimum Peak Wavelength (nm)	Maximum Peak Wavelength (nm)
3	440	445
4	445	450
5	450	455
6	455	460

Red, deep red, red-orange and amber LUXEON Rebel color emitters are tested and binned for dominant wavelength.

Dominant Wavelength Bin Structure for Red Emitters

Table 18.

Bin Code	Minimum Dominant Wavelength (nm)	Maximum Dominant Wavelength (nm)
4	620.0	630.0
5	630.0	645.0

Dominant Wavelength Bin Structure for Red-Orange Emitters

Table 19.

Bin Code	Minimum Dominant Wavelength (nm)	Maximum Dominant Wavelength (nm)
2	610.0	620.0

Dominant Wavelength Bin Structure for Amber Emitters

Table 20.

Bin Code	Minimum Dominant Wavelength (nm)	Maximum Dominant Wavelength (nm)
1	584.5	587.0
2	587.0	589.5
4	589.5	592.0
6	592.0	594.5
7	594.5	597.0

Dominant Wavelength Bin Structure for Deep Red Emitters

Table 21.

Bin Code	Minimum Dominant Wavelength (nm)	Maximum Dominant Wavelength (nm)
6	650	660
7	660	670

Table 22.

PC Amber Bin Coordinates		
Bin Code	x	y
2	0.5622	0.4372
	0.5576	0.4326
	0.5775	0.4132
	0.5843	0.4151
4	0.5705	0.4111
	0.5775	0.4132
	0.5576	0.4326
	0.5499	0.4249

Note for Table 22:

- LUXEON Rebel PC amber emitters are tested and binned by x,y coordinates.

Color Bins PC Amber



Figure 38. Color bin structure.

Company Information

Philips Lumileds is a leading provider of power LEDs for everyday lighting applications. The company's records for light output, efficacy and thermal management are direct results of the ongoing commitment to advancing solid-state lighting technology and enabling lighting solutions that are more environmentally friendly, help reduce CO₂ emissions and reduce the need for power plant expansion. Philips Lumileds LUXEON® LEDs are enabling never before possible applications in outdoor lighting, shop lighting, home lighting, digital imaging, display and automotive lighting.

Philips Lumileds is a fully integrated supplier, producing core LED material in all three base colors, (Red, Green, Blue) and white. Philips Lumileds has R&D centers in San Jose, California and in the Netherlands, and production capabilities in San Jose, Singapore and Penang, Malaysia. Founded in 1999, Philips Lumileds is the high flux LED technology leader and is dedicated to bridging the gap between solid-state technology and the lighting world. More information about the company's LUXEON LED products and solid-state lighting technologies can be found at www.philipslumileds.com.

www.philipslumileds.com
www.philipslumileds.cn.com
www.futurelightingsolutions.com

For technical assistance or the location of your nearest sales office contact any of the following:

North America:
1 888 589 3662
americas@futurelightingsolutions.com

Europe:
00 800 443 88 873
europe@futurelightingsolutions.com

Asia Pacific:
800 5864 5337
asia@futurelightingsolutions.com

Japan:
800 5864 5337
japan@futurelightingsolutions.com

©2011 Philips Lumileds Lighting Company. All rights reserved.
Product specifications are subject to change without notice.
LUXEON is a registered trademark of the Philips Lumileds Lighting Company in the United States and other countries.

PHILIPS
LUMILEDS

Компания «Life Electronics» занимается поставками электронных компонентов импортного и отечественного производства от производителей и со складов крупных дистрибьюторов Европы, Америки и Азии.

С конца 2013 года компания активно расширяет линейку поставок компонентов по направлению коаксиальный кабель, кварцевые генераторы и конденсаторы (керамические, пленочные, электролитические), за счёт заключения дистрибьюторских договоров

Мы предлагаем:

- Конкурентоспособные цены и скидки постоянным клиентам.
- Специальные условия для постоянных клиентов.
- Подбор аналогов.
- Поставку компонентов в любых объемах, удовлетворяющих вашим потребностям.
- Приемлемые сроки поставки, возможна ускоренная поставка.
- Доставку товара в любую точку России и стран СНГ.
- Комплексную поставку.
- Работу по проектам и поставку образцов.
- Формирование склада под заказчика.
- Сертификаты соответствия на поставляемую продукцию (по желанию клиента).
- Тестирование поставляемой продукции.
- Поставку компонентов, требующих военную и космическую приемку.
- Входной контроль качества.
- Наличие сертификата ISO.

В составе нашей компании организован Конструкторский отдел, призванный помогать разработчикам, и инженерам.

Конструкторский отдел помогает осуществить:

- Регистрацию проекта у производителя компонентов.
- Техническую поддержку проекта.
- Защиту от снятия компонента с производства.
- Оценку стоимости проекта по компонентам.
- Изготовление тестовой платы монтаж и пусконаладочные работы.



Тел: +7 (812) 336 43 04 (многоканальный)

Email: org@lifeelectronics.ru