



Product Description

GRF4002 is a broadband low noise gain block designed for small cell, wireless infrastructure and other high performance applications. It exhibits outstanding broadband NF, linearity and return losses over 700 to 3800 MHz with a single match.

Configured as a first stage LNA, linear driver or cascaded gain block, GRF4002 offers high levels of reuse both within a design and across platforms. The device is operated from a supply voltage (V_{DD}) of 1.8 to 5.0 V with a selectable I_{DDQ} range of 20 to 80 mA for optimal efficiency and linearity.

GRF4002 is internally matched to 50Ω at the input and output ports, needing only external DC blocks and a bias choke on the output.

Consult with the GRF applications engineering team for custom tuning/evaluation board data. Packaged device s-parameters are available on the website landing page.

Features

Reference: 5V/70mA/2.5 GHz

- EVB NF: 0.85 dB
- Gain: 15.0 dB
- OP1dB: 23.5 dBm
- OIP3: 36.5 dBm
- Flexible Bias Voltage and Current
- Internally Matched to 50Ω
- Process: GaAs pHEMT

Applications

- Linear Driver Amplifier
- Small Cells and Cellular Repeaters
- Distributed Antenna Systems
- Microwave Backhaul

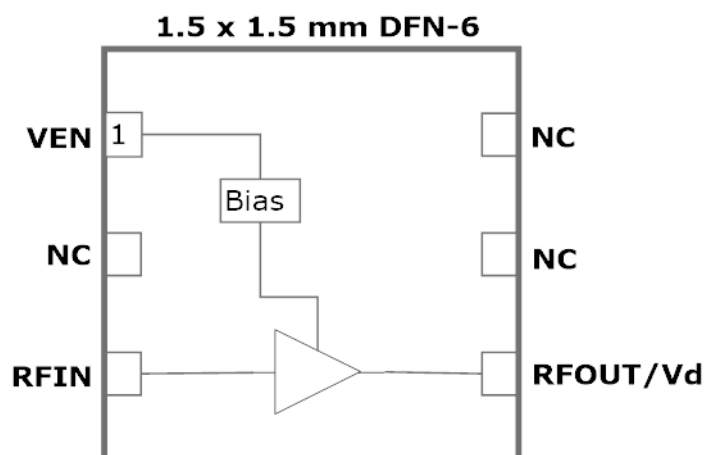

Absolute Ratings:

Parameter	Symbol	Min.	Max.	Unit
Supply Voltage	V _{DD}	0	6.0	V
RF Input Power: (Load VSWR < 2:1; V _D : 5.0 volts)	P _{IN MAX}		22	dBm
Operating Temperature (Package Heat Sink)	T _{AMB}	-40	105	°C
Maximum Channel Temperature (MTTF > 10 ⁶ Hours)	T _{MAX}		170	°C
Maximum Dissipated Power	P _{DISS MAX}		500	mW
Electrostatic Discharge:				
Charged Device Model:	CDM	1500		V
Human Body Model:	HBM	250		V
Storage:				
Storage Temperature	T _{STG}	-65	150	°C
Moisture Sensitivity Level	MSL		1	--



Caution! ESD Sensitive Device



Exceeding Absolute Maximum Rating conditions may cause permanent damage to the device.

Note: For package dimensions and manufacturing information, see the Guerrilla-RF.com website for the following document located on the GRF4002 landing page: **Manufacturing Note—MN-001 Product Tape and Reel, Solderability and Package Outline Specification.**

[Link to manufacturing note](#)

Pin Out (Top View)



Pin Assignments:

Pin	Name	Description	Note
1	V _{ENABLE}	Enable Voltage Input	V _{ENABLE} and series resistor set I _{DDQ} . V _{ENABLE} < =0.2 volts disables device. On -die pull-down resistor will turn the part off if this node is allowed to float.
2	NC	No Connect or Ground	No internal connection to die
3	RF_In	LNA RF input	Internally matched 50Ω. An external DC blocking cap must be used.
4	RF_Out	LNA RF output	Internally matched 50Ω. V _{DD} must be applied through a choke to this pin
5	NC	No Connect or Ground	No internal connection to die
6	NC	No Connect or Ground	No internal connection to die
PKG BASE	GND	Ground	Provides DC and RF ground for LNA, as well as thermal heat sink. Recommend multiple 8 mil vias beneath the package for optimal RF and thermal performance. Refer to evaluation board top layer graphic on schematic page.



Released

GRF4002

Broadband LNA/Linear Driver
0.1–3.8 GHz

Nominal Operating Parameters:

Parameter	Symbol	Specification			Unit	Condition
		Min.	Typ.	Max.		
Test Frequency	F _{TEST}		2500		MHz	V _{DD} = 5.0 V, T _A = 25 °C
Gain	S ₂₁	14.0	15.0		dB	
Evaluation Board Noise Figure	NF		0.85	1.0	dB	
Output 3rd Order Intercept	OIP ₃		36.5		dBm	2.0 dBm P _{OUT} per tone at 2 MHz Spacing (2499 and 2501 MHz)
Output 1dB Compression Point	OP _{1dB}	22.0	23.5		dBm	
Switching Rise Time	T _{RISE}		500		ns	
Switching Fall Time	T _{FALL}		500		ns	
Supply Current	I _{DD}		70.0		mA	V _{DD} =V _{ENABLE} = 5.0V; M5: 1500 ohms
Enable Current	I _{ENABLE}		3.0	6.0	mA	
Disabled Mode						
Leakage Current	I _{LEAKAGE}		40	100	uA	V _{DD} : 5.0V; V _{ENABLE} : 0.0V
Thermal Data						
Thermal Resistance: (Infra-Red Scan)	Θ _{jc}		131		°C/W	On standard Evaluation Board
Channel Temperature @ +85 C Reference (Package heat sink)	T _{CHANNEL}		131		°C	V _{DD} : 5.0 V; I _{DDQ} : 70 mA; No RF; P _{DISS} : 350 mW



Released

GRF4002

Broadband LNA/Linear Driver
0.1–3.8 GHz

GRF4002 Evaluation Board Measured Data:

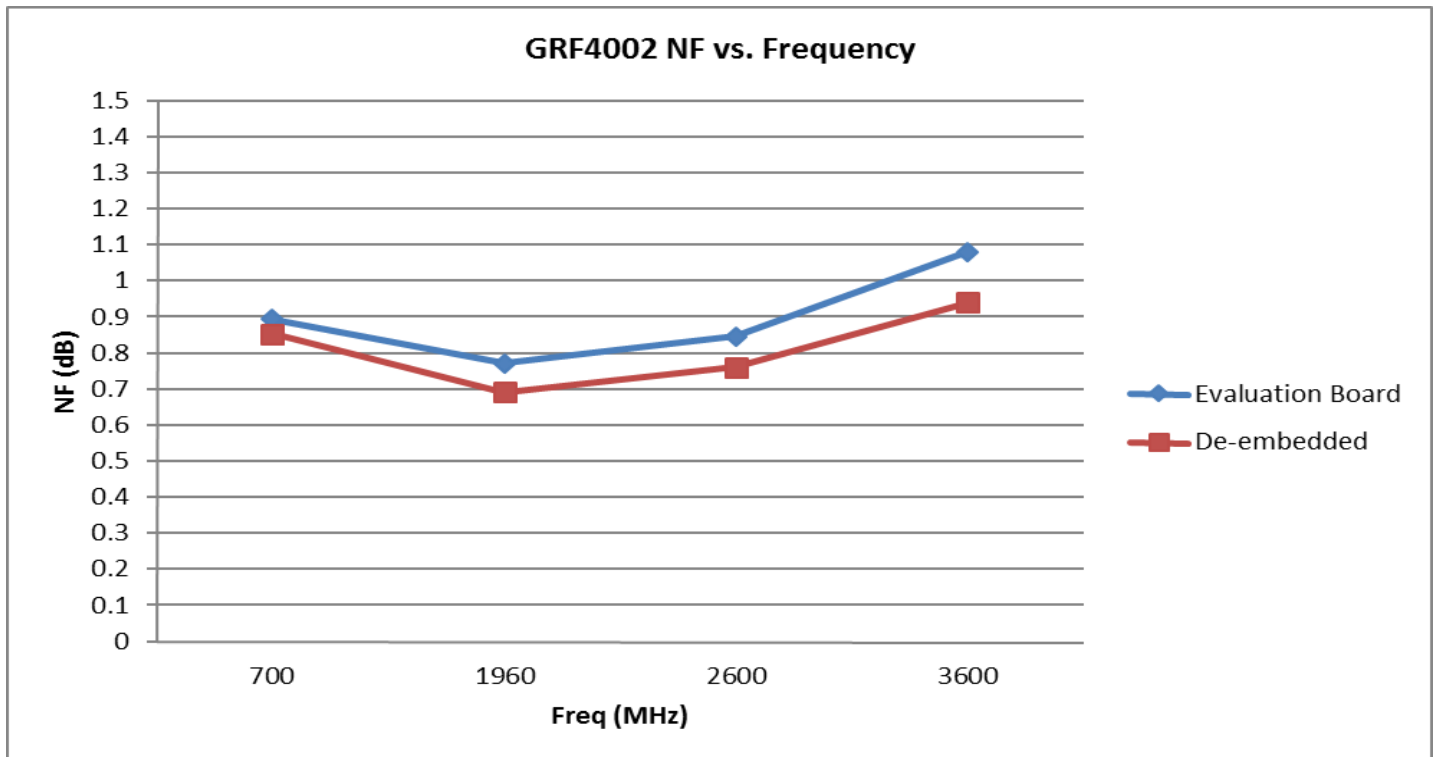
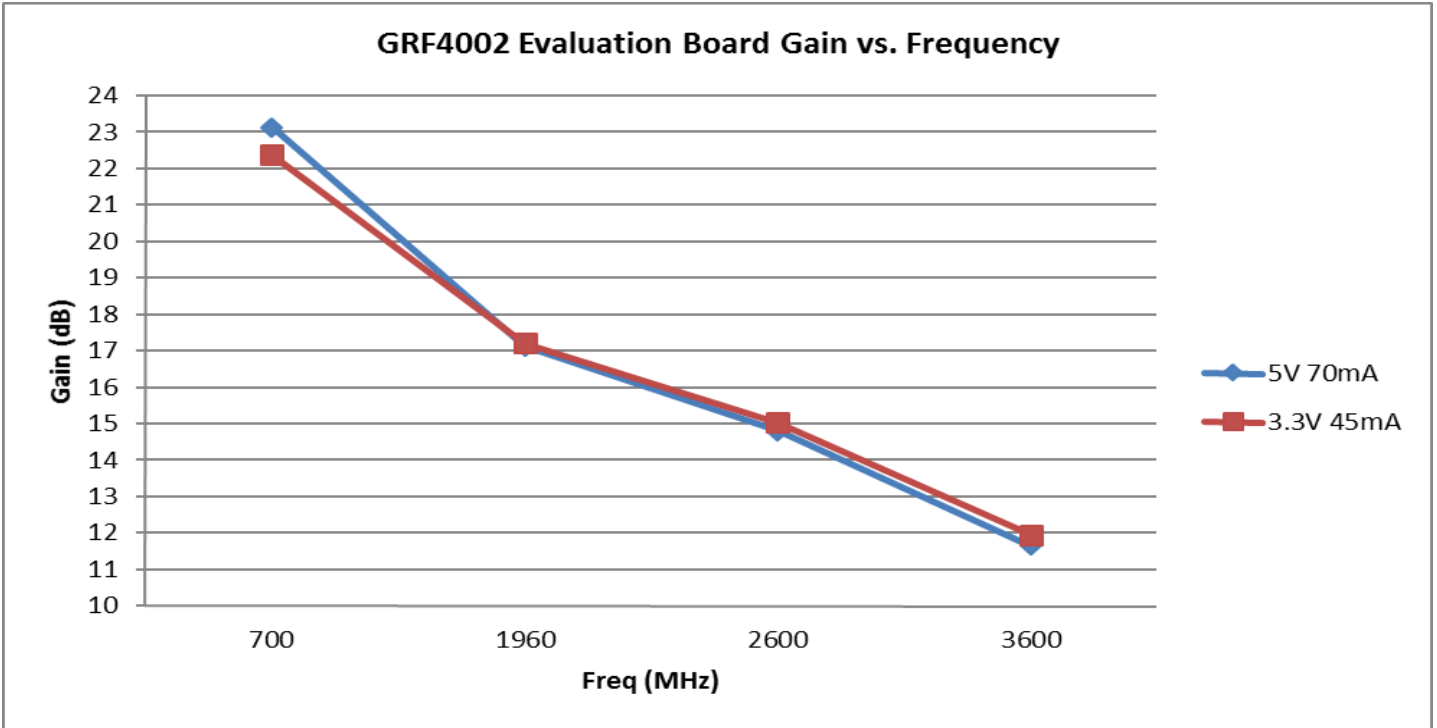



Released

GRF4002

Broadband LNA/Linear Driver
0.1–3.8 GHz

GRF4002 Evaluation Board Measured Data:

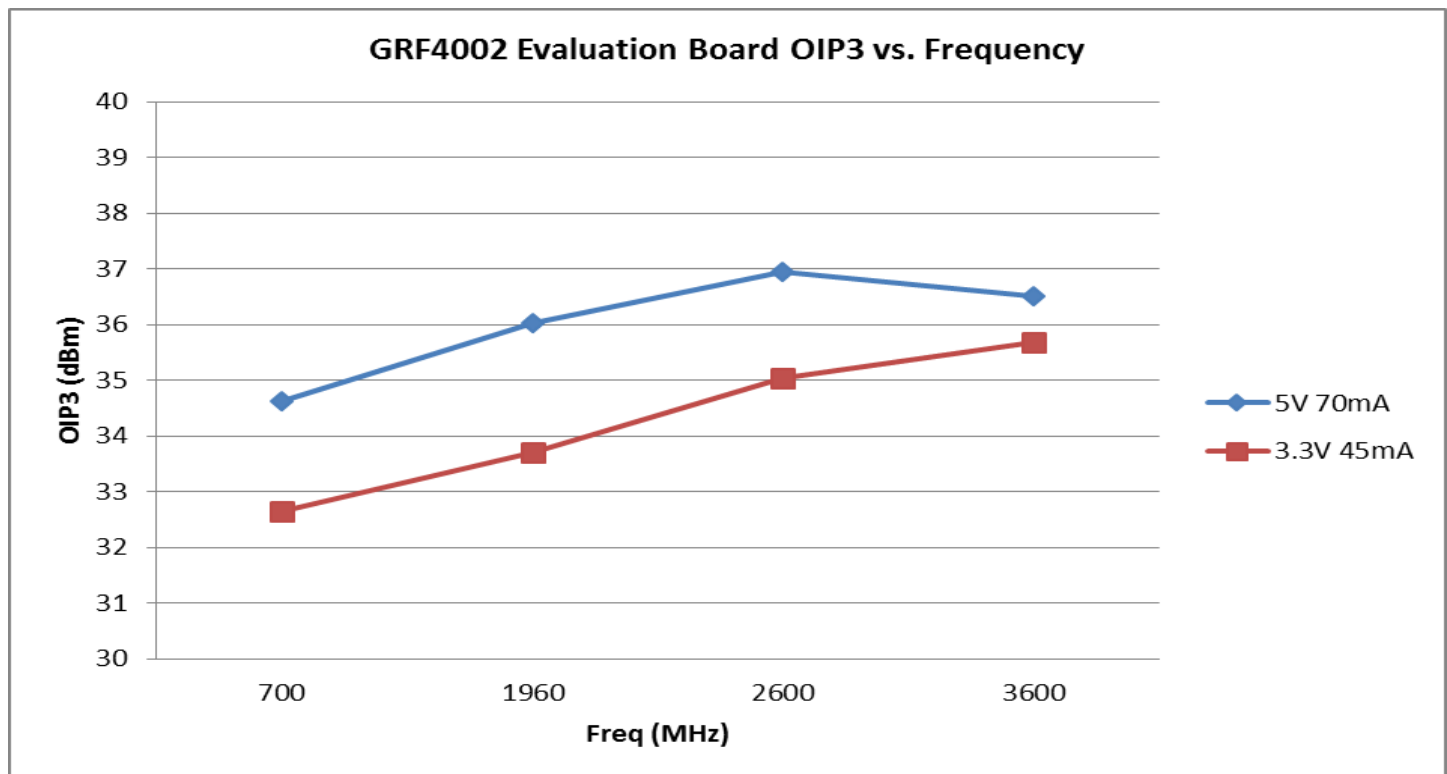
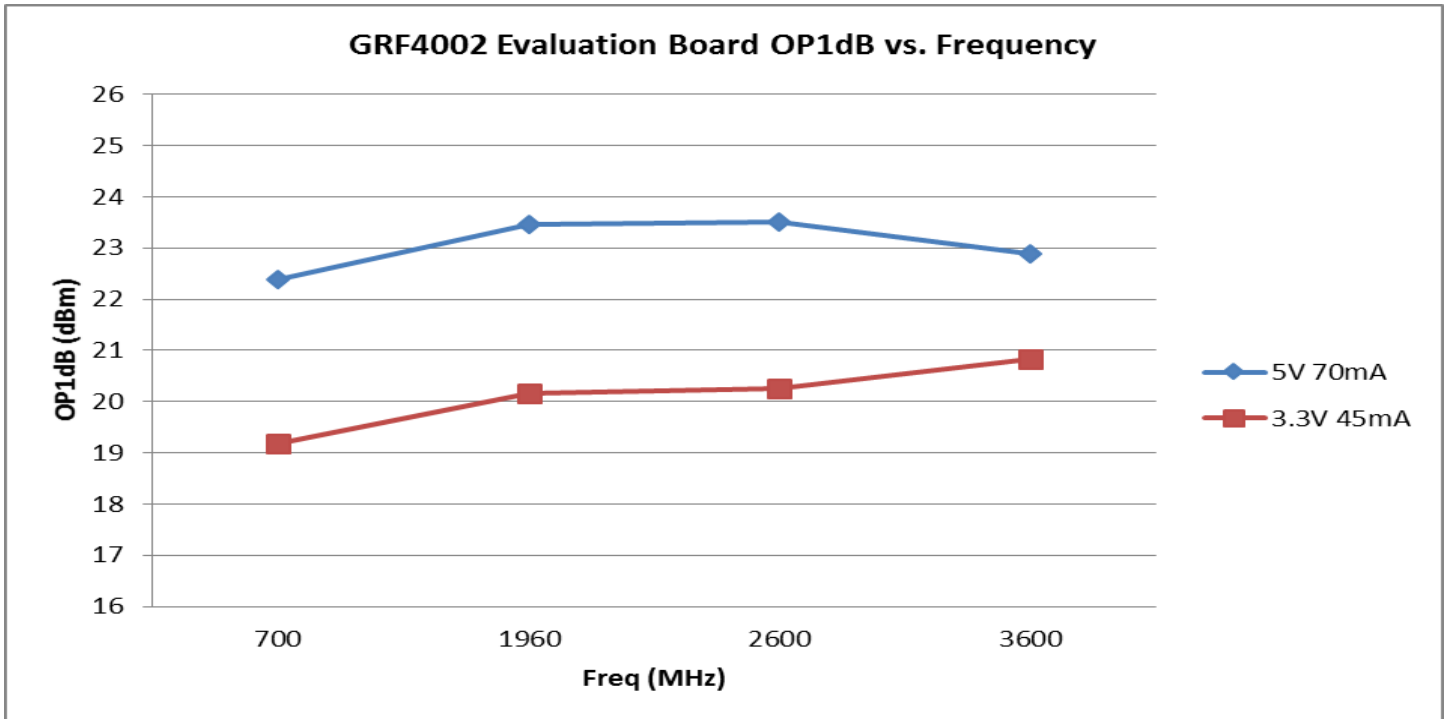

GRF4002 Evaluation Board Performance over Temperature: (5V/70mA)

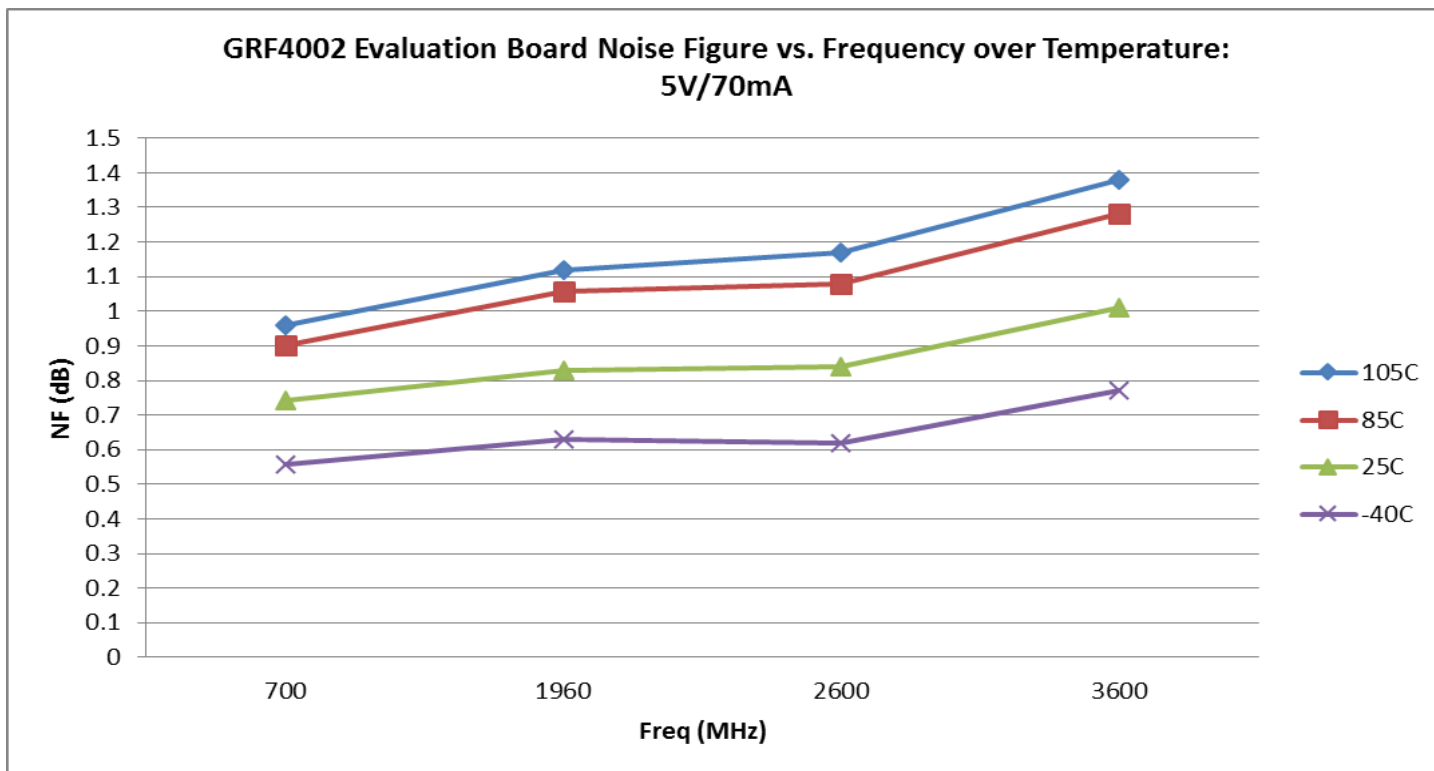
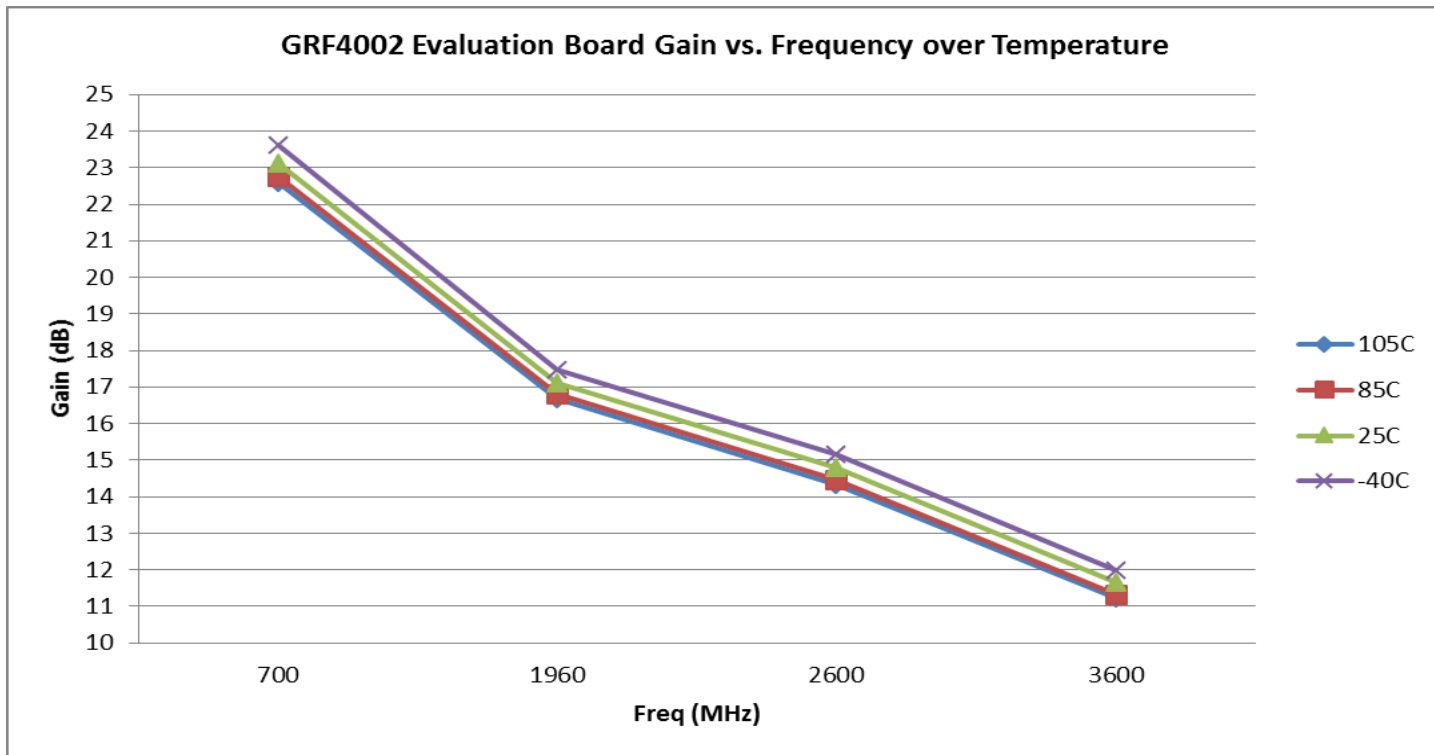



Released

GRF4002

Broadband LNA/Linear Driver
0.1–3.8 GHz

GRF4002 Evaluation Board Performance over Temperature: (5V/70mA)

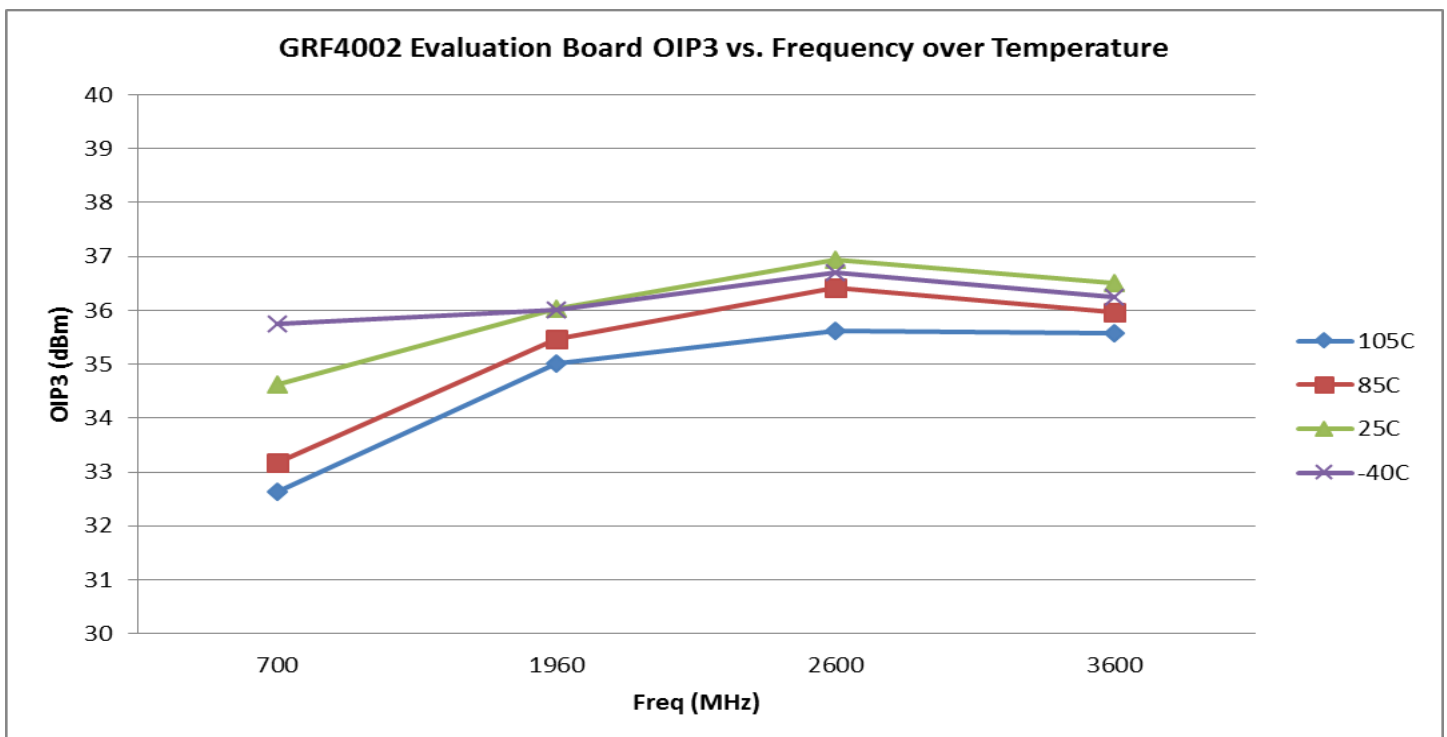
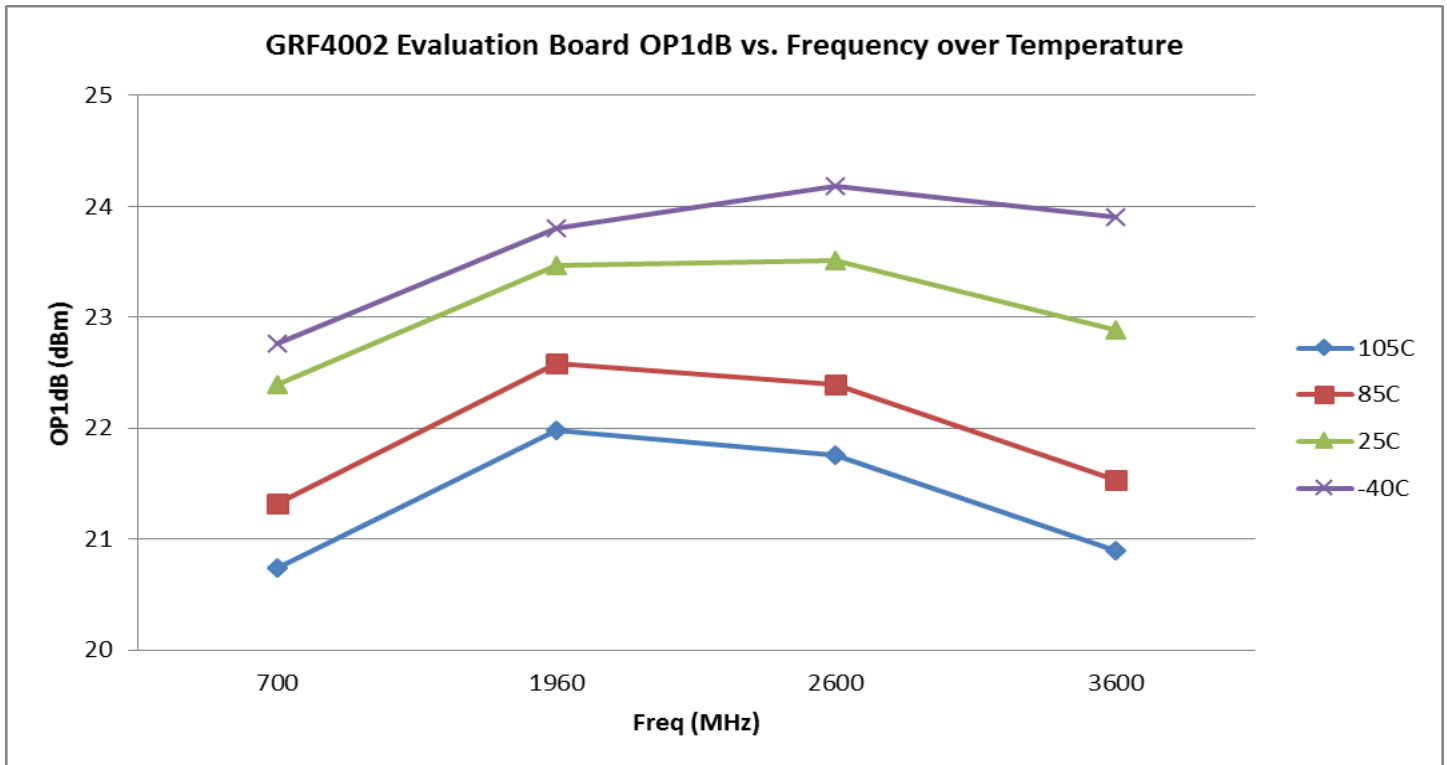



Released

GRF4002

Broadband LNA/Linear Driver
0.1–3.8 GHz

GRF4002 Evaluation Board S-Pars and Stability Mu Factor: (0.7 – 3.8 GHz Match)

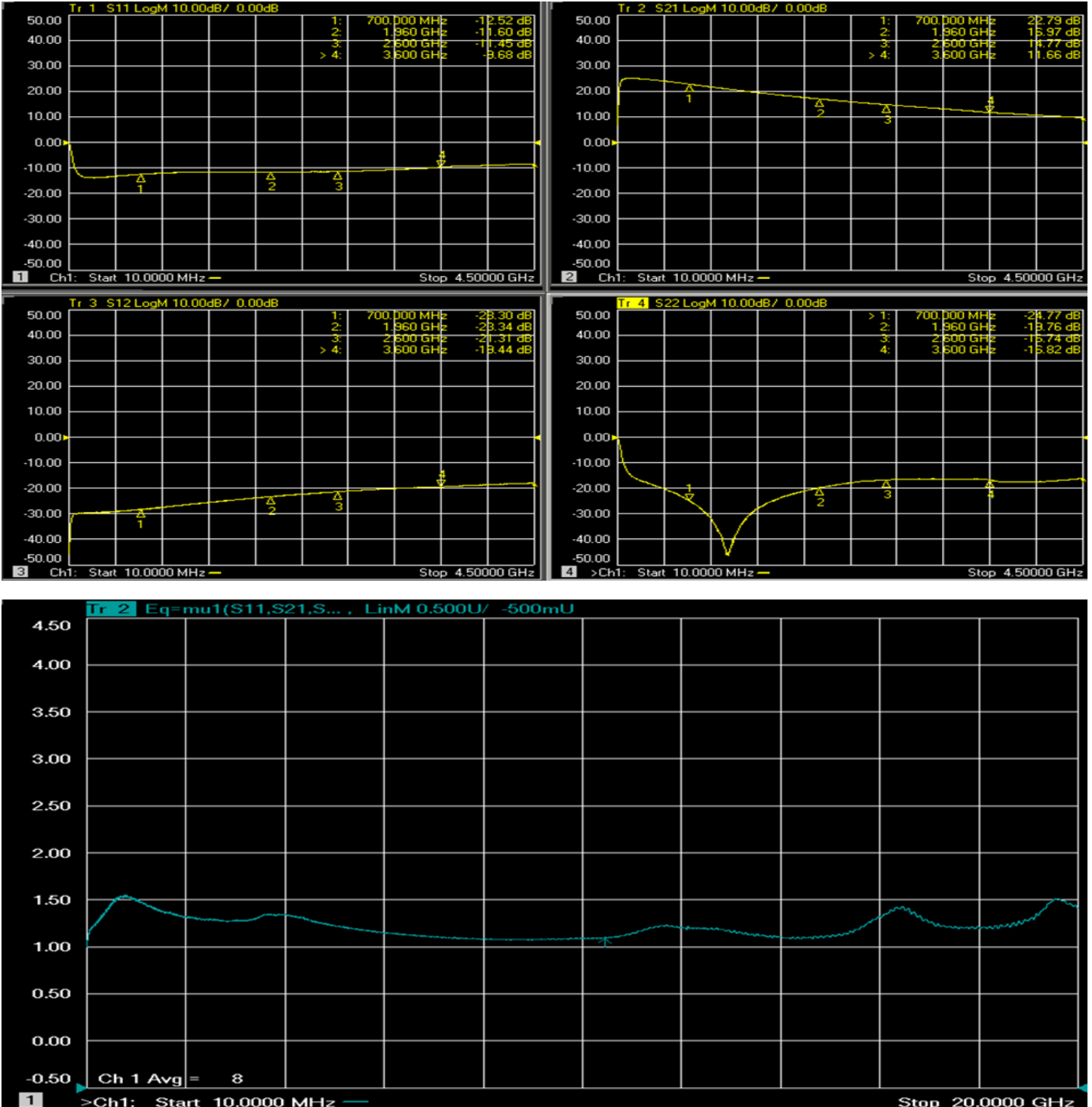

Note: Mu factor ≥ 1.0 implies unconditional stability.

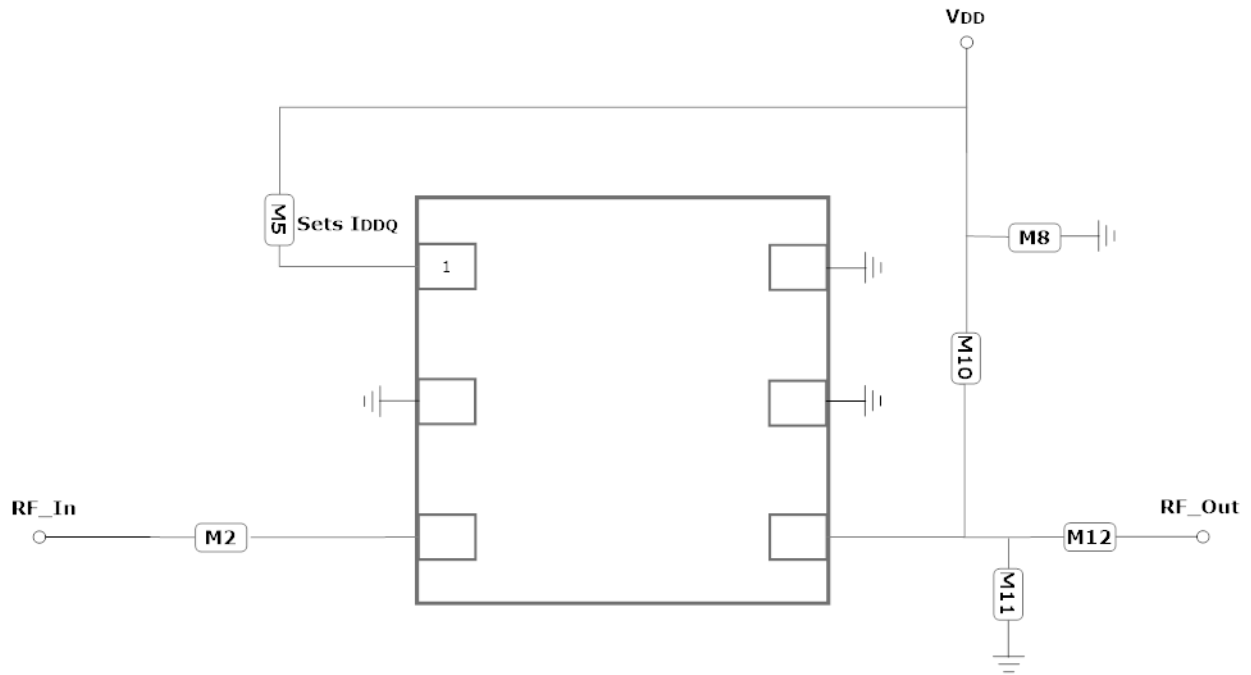

GRF4002 Application Schematic

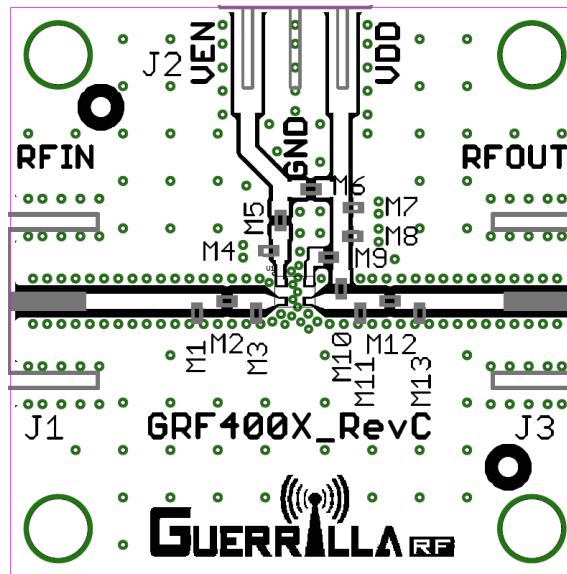

GRF400X Evaluation Board Assembly Diagram



Released

GRF4002

Broadband LNA/Linear Driver
0.1–3.8 GHz

GRF4002 Standard Evaluation Board BOM: (0.1 to 3.8 GHz Tune)

Component	Type	Manufacturer	Family	Value	Package Size	Substitution
M2	Capacitor	Murata	GRM	100 pF	0402	ok
M5 (See curves)	Resistor	Various	5%	Sets Iddq	0402	ok
M8	Capacitor	Murata	GRM	0.1 uF	0402	ok
M10	Inductor	Coilcraft	HP	100 nH	0402	ok
M11	Capacitor	Murata	GRM/GJM	0.5 pF	0402	ok
M12	Capacitor	Murata	GRM	100 pF	0402	ok

GRF4002 Bias Resistor Selection Chart

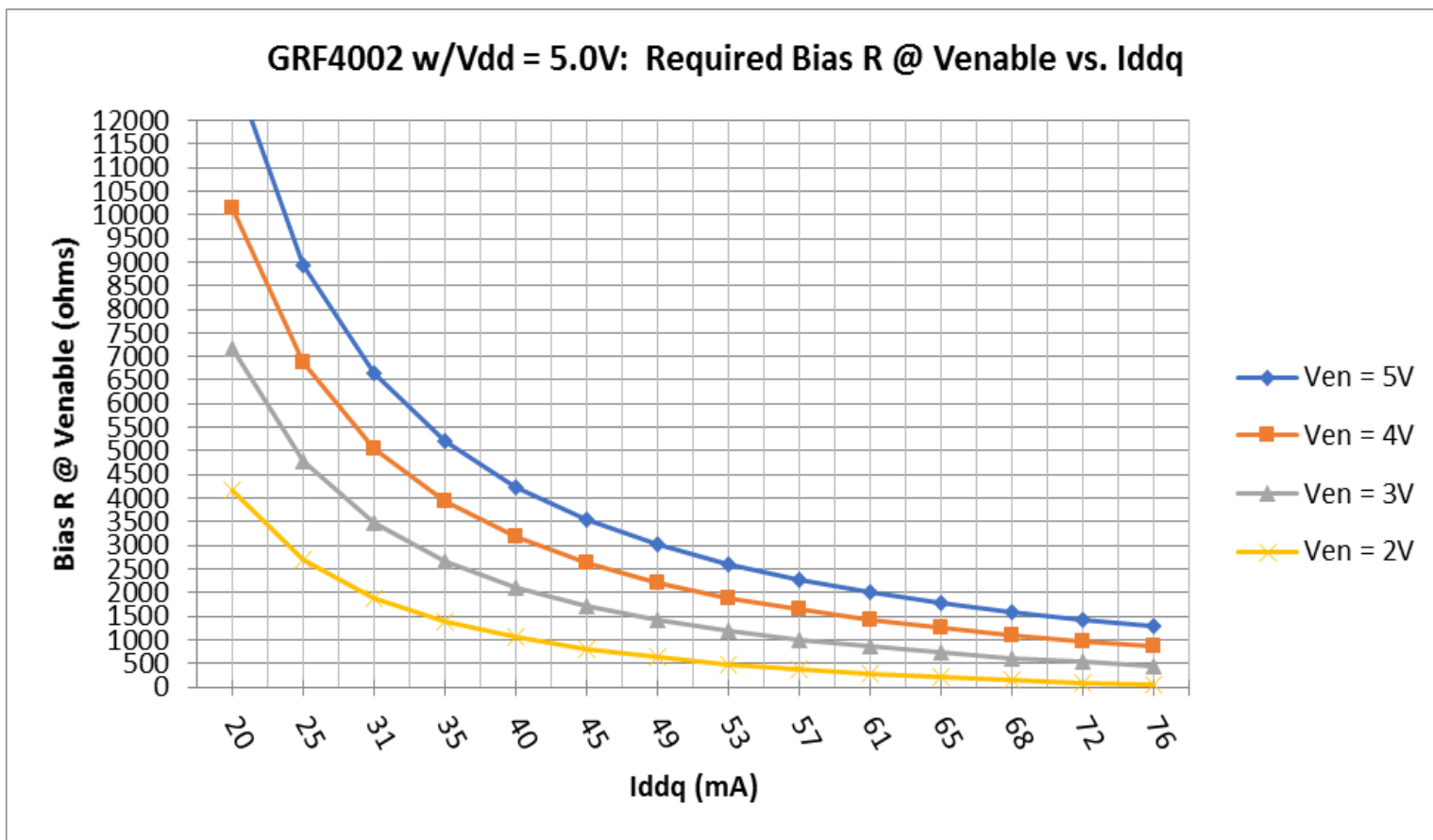



Released

GRF4002

Broadband LNA/Linear Driver

0.1–3.8 GHz

Data Sheet Release Status:	Notes
Advance	S-parameter and NF data based on EM simulations for the fully packaged device using foundry supplied transistor s-parameters. Linearity estimates based on device size, bias condition and experience with related devices.
Preliminary	All data based on evaluation board measurements in the Guerrilla RF Applications Lab.
Released	All data based on device qualification data. Typically, this data is nearly identical to the data found in the preliminary version. Max and min values for key RF parameters are included.

Information in this datasheet is specific to the Guerrilla RF, Inc. (“Guerrilla RF”) product identified.

This datasheet, including the information contained in it, is provided by Guerrilla RF as a service to its customers and may be used for informational purposes only by the customer. Guerrilla RF assumes no responsibility for errors or omissions on this datasheet or the information contained herein. Information provided is believed to be accurate and reliable, however, no responsibility is assumed by Guerrilla RF for its use, nor for any infringement of patents, or other rights of third parties, resulting from its use. Guerrilla RF assumes no liability for any datasheet, datasheet information, materials, products, product information, or other information provided hereunder, including the sale, distribution, reproduction or use of Guerrilla RF products, information or materials.

No license, whether express, implied, by estoppel, by implication or otherwise is granted by this datasheet for any intellectual property of Guerrilla RF, or any third party, including without limitation, patents, patent rights, copyrights, trademarks and trade secrets. All rights are reserved by Guerrilla RF.

All information herein, products, product information, datasheets, and datasheet information are subject to change and availability without notice. Guerrilla RF reserves the right to change component circuitry, recommended application circuitry and specifications at any time without prior notice. Guerrilla RF may further change its datasheet, product information, documentation, products, services, specifications or product descriptions at any time, without notice. Guerrilla RF makes no commitment to update any materials or information and shall have no responsibility whatsoever for conflicts, incompatibilities, or other difficulties arising from any future changes.

GUERRILLA RF INFORMATION, PRODUCTS, PRODUCT INFORMATION, DATASHEETS AND DATASHEET INFORMATION ARE PROVIDED “AS IS” AND WITHOUT WARRANTY OF ANY KIND, WHETHER EXPRESS, IMPLIED, STATUTORY, OR OTHERWISE, INCLUDING FITNESS FOR A PARTICULAR PURPOSE OR USE, MERCHANTABILITY, PERFORMANCE, QUALITY OR NON-INFRINGEMENT OF ANY INTELLECTUAL PROPERTY RIGHT; ALL SUCH WARRANTIES ARE HEREBY EXPRESSLY DISCLAIMED. GUERRILLA RF DOES NOT WARRANT THE ACCURACY OR COMPLETENESS OF THE INFORMATION, TEXT, GRAPHICS OR OTHER ITEMS CONTAINED WITHIN THESE MATERIALS. GUERRILLA RF SHALL NOT BE LIABLE FOR ANY DAMAGES, INCLUDING BUT NOT LIMITED TO ANY SPECIAL, INDIRECT, INCIDENTAL, STATUTORY, OR CONSEQUENTIAL DAMAGES, INCLUDING WITHOUT LIMITATION, LOST REVENUES OR LOST PROFITS THAT MAY RESULT FROM THE USE OF THE MATERIALS OR INFORMATION, WHETHER OR NOT THE RECIPIENT OF MATERIALS HAS BEEN ADVISED OF THE POSSIBILITY OF SUCH DAMAGE.

Customers are solely responsible for their use of Guerrilla RF products in the Customer’s products and applications or in ways which deviate from Guerrilla RF’s published specifications, either intentionally or as a result of design defects, errors, or operation of products outside of published parameters or design specifications. Customers should include design and operating safeguards to minimize these and other risks. Guerrilla RF assumes no liability or responsibility for applications assistance, customer product design, or damage to any equipment resulting from the use of Guerrilla RF products outside of stated published specifications or parameters.

Guerrilla RF Proprietary Information. Guerrilla RF™ and the composite logo of Guerrilla RF™ are trademarks of Guerrilla RF, Inc. ©2014 Guerrilla RF, Inc. All rights reserved.

Компания «Life Electronics» занимается поставками электронных компонентов импортного и отечественного производства от производителей и со складов крупных дистрибьюторов Европы, Америки и Азии.

С конца 2013 года компания активно расширяет линейку поставок компонентов по направлению коаксиальный кабель, кварцевые генераторы и конденсаторы (керамические, пленочные, электролитические), за счёт заключения дистрибьюторских договоров

Мы предлагаем:

- Конкурентоспособные цены и скидки постоянным клиентам.
- Специальные условия для постоянных клиентов.
- Подбор аналогов.
- Поставку компонентов в любых объемах, удовлетворяющих вашим потребностям.
- Приемлемые сроки поставки, возможна ускоренная поставка.
- Доставку товара в любую точку России и стран СНГ.
- Комплексную поставку.
- Работу по проектам и поставку образцов.
- Формирование склада под заказчика.
- Сертификаты соответствия на поставляемую продукцию (по желанию клиента).
- Тестирование поставляемой продукции.
- Поставку компонентов, требующих военную и космическую приемку.
- Входной контроль качества.
- Наличие сертификата ISO.

В составе нашей компании организован Конструкторский отдел, призванный помогать разработчикам, и инженерам.

Конструкторский отдел помогает осуществить:

- Регистрацию проекта у производителя компонентов.
- Техническую поддержку проекта.
- Защиту от снятия компонента с производства.
- Оценку стоимости проекта по компонентам.
- Изготовление тестовой платы монтаж и пусконаладочные работы.



Тел: +7 (812) 336 43 04 (многоканальный)

Email: org@lifeelectronics.ru