

ZXCT1082Q/83Q/84Q/85Q/86Q/87Q

AUTOMOTIVE GRADE PRECISION HIGH VOLTAGE HIGH-SIDE CURRENT MONITORS

Description

The ZXCT1082Q/83Q/84Q/85Q/86Q/87Q are high side unipolar current sense monitors. These devices eliminate the need to disrupt the ground plane when sensing a load current.

The ZXCT1082Q/1084Q/1086Q have 60V maximum operating voltages and ZXCT1083Q/1085Q/1087Q have 40V maximum operating voltages.

The wide common-mode input voltage range and low quiescent currents coupled with SOT25 packages make them suitable for a range of applications; including automotive and systems operating from industrial 24-28V rails.

Their quiescent current is only 0.6µA thereby minimizing current sensing error.

The ZXCT1082Q and ZXCT1083Q use three external transconductance/gain setting resistors which increase versatility by permitting wide gain ranges and optimization of bandwidths.

The ZXCT1084Q/85Q/86Q/87Q are fixed gain voltage output counterparts of the ZXCT1082Q/83.

The ZXCT1082Q/3Q/4Q/5Q/6Q/7Q have been qualified to AEC-Q100 Grade 1 and are Automotive Grade supporting PPAPs.

Features

- Wide supply and common-mode voltage range
 - 2.7V to 60V ZXCT1082Q/84Q/86Q
 - 2.7V to 40V ZXCT1083Q/85Q/87Q
- Independent supply and input common-mode voltage
- Low quiescent current (0.6µA).
- AEC-Q100 Grade 1 qualified
- Extended industrial temperature range -40 to +125°C
- SOT25 package in Green Molding
 - **Totally Lead-Free & Fully RoHS Compliant (Notes 1 & 2)**
 - **Halogen and Antimony Free. "Green" Device (Note 3)**
- Automotive Grade
 - **Qualified to AEC-Q100 Standards for High Reliability**
 - **PPAP Capable (Note 4)**

Applications

- Automotive current measurement
- Automotive battery management
- Automotive over current monitor

Notes: 1. No purposely added lead. Fully EU Directive 2002/95/EC (RoHS) & 2011/65/EU (RoHS 2) compliant.
 2. See http://www.diodes.com/quality/lead_free.html for more information about Diodes Incorporated's definitions of Halogen- and Antimony-free, "Green" and Lead-free.
 3. Halogen- and Antimony-free "Green" products are defined as those which contain <900ppm bromine, <900ppm chlorine (<1500ppm total Br + Cl) and <1000ppm antimony compounds.
 4. Automotive products are AEC-Q100 qualified and are PPAP capable. Automotive, AEC-Q100 and standard products are electrically and thermally the same, except where specified. For more information, please refer to http://www.diodes.com/quality/product_compliance_definitions.

Pin Assignments

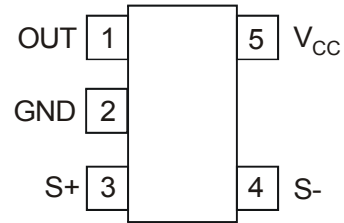

Typical Application Circuits

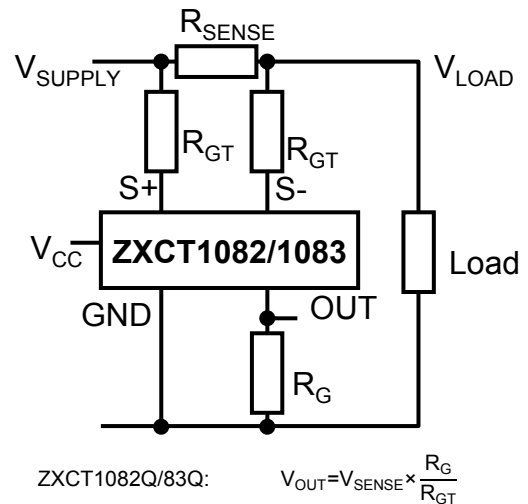
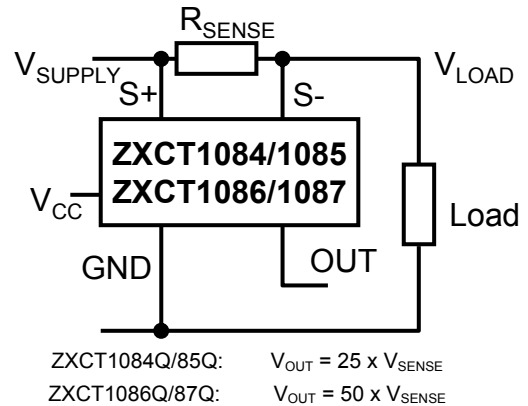

ZXCT1082Q/83Q/84Q/85Q/86Q/87Q

Pin Description

PIN	Name	Function		
		Common	ZXCT1082Q/83Q	ZXCT1084Q/85Q/86Q/87Q
1	OUT	Output pin.	Current output.	Voltage output
2	GND	Ground pin.		
3	S+	This is the positive input of the current monitor. It has a wide common-mode input range. The current through this pin varies with differential sense voltage.	An external resistor, R_{GT} , should be connected from S+ to the input side (V_{SUPPLY}) of the sense resistor	Should be directly connected to the input side (V_{SUPPLY}) of the sense resistor.
4	S-	This is the negative input of the current monitor. It has a wide common-mode input range.	An external resistor, R_{GT} , should be connected from S- to the load side (V_{LOAD}) of the sense resistor.	Should be directly connected to the load side (V_{LOAD}) of the sense resistor.
5	V_{CC}	This is the analogue supply and provides power to internal circuitry.		

Absolute Maximum Ratings

Parameter	Rating		Unit
	ZXCT1082Q/84Q/86Q	ZXCT1083Q/85Q/87Q	
Voltage on S- and S+	-0.3 to 65	-0.3 to 45	V
Voltage on V_{CC}	-0.3 to 65	-0.3 to 45	V
Voltage on OUT	-0.3 to V_{S-}		V
Differential Input Voltage, $V_{S+} - V_{S-}$ (Notes 5, and 6)	±800		mV
Input current into S+ or S- (Notes 5, and 6)	±12		mA
Storage Temperature	-55 to +150		°C
Maximum Junction Temperature	+150		°C
Package Power Dissipation (De-rate to zero at +150°C)	300 at $T_A = +25^\circ\text{C}$		mW
ESD Rating			
HBM	Human Body Model	3	kV
MM	Machine Model	250	V
CDM	Charged Device Model	tbd	kV

Caution: Stresses greater than the 'Absolute Maximum Ratings' specified above, may cause permanent damage to the device. These are stress ratings only; functional operation of the device at these or any other conditions exceeding those indicated in this specification is not implied. Device reliability may be affected by exposure to absolute maximum rating conditions for extended periods of time.

Semiconductor devices are ESD sensitive and may be damaged by exposure to ESD events. Suitable ESD precautions should be taken when handling and transporting these devices.

Notes: 5. For the ZXCT1082/83 $V_{SENSE} = "V_{SUPPLY}" - "V_{LOAD}"$ where V_{LOAD} is the load voltage or the lower potential side of the sense resistor.

For the ZXCT1083/84/85/86 $V_{SENSE} = "V_{S+}" - "V_{S-}"$

6. The differential input voltage limit, $V_{S+} - V_{S-}$, may be exceeded provided that the input current limit into S+ or S- is not exceeded

Recommended Operating Conditions

Symbol	Parameter	Min	Max	Units
V_{IN}	ZXCT1083Q/1085Q/1087Q Common-Mode Input Range	2.7	40	V
	ZXCT1082Q/1084Q/1086Q Common-Mode Input Range	2.7	60	V
V_{CC}	ZXCT1083Q/1085Q/1087Q Supply Voltage Range	2.7	40	V
	ZXCT1082Q/1084Q/1086Q Supply Voltage Range	2.7	60	V
V_{SENSE}	Differential Sense Input Voltage Range	0	0.5	V
V_{OUT}	Output Voltage Range (Note 5)	0	$V_{S-} - 1$	V
T_A	Ambient Temperature Range	-40	+125	°C

ZXCT1082Q/83Q/84Q/85Q/86Q/87Q

Electrical Characteristics

Test Conditions $T_A = +25^\circ\text{C}$, $V_{S+} = 12\text{V}$, $V_{CC} = 5\text{V}$, $V_{\text{SENSE}} = 100\text{mV}$ (Note 5), ZXCT1082Q/83Q $R_{GT} = 5\text{k}\Omega$, $R_G = 125\text{k}\Omega$; unless otherwise stated. (FT = -40°C to $+125^\circ\text{C}$)

Symbol	Parameter	Conditions	Min	Typ	Max	Units
Input						
I_{S+}	S+ input current	$V_{\text{SENSE}} = 0\text{mV}$ (Note 5)	—	1.7	—	μA
			$T_A = \text{FT}$	—	5	
I_{S-}	S- input current	$V_{\text{SENSE}} = 0\text{mV}$ (Note 5)	—	1.7	—	μA
			$T_A = \text{FT}$	—	5	
V_{IO}	Input Offset Voltage (Note 7)	$V_{\text{SENSE}} = 0\text{mV}$	—	± 0.2	± 1	mV
		ZXCT1082Q/ 83Q/ 84Q/ 85Q	$T_A = \text{FT}$	—	± 2.5	
		ZXCT1086Q/ 87Q	$T_A = \text{FT}$	—	± 3	
		Temperature co-efficient	—	± 4	—	$\mu\text{V}/\text{K}$
Output						
G_T	Transconductance		—	200	—	$\mu\text{A}/\text{V}$
G_{T-ERR}	Transconductance error (Note 9)	ZXCT1082Q/83Q $V_{\text{SENSE}} = 10\text{mV}$ to 150mV (Notes 5, 8)	—	—	+1	%
			$T_A = \text{FT}$	-2	—	
G_{T-TC}	Transconductance temperature co-efficient		$T_A = \text{FT}$	10	—	nA/K
Z_{OUT}	Output impedance	ZXCT1082Q/83Q	—	$1 \parallel 5$	—	$\text{G}\Omega \parallel \text{pF}$
G_V	Gain		ZXCT1084Q/85Q	—	25	V/V
			ZXCT1086Q/87Q	—	50	
G_{V-ERR}	Gain error (Note 9)	ZXCT1084Q/85Q/86Q/87Q $V_{\text{SENSE}} = 10\text{mV}$ to 150mV (Note 5)	—	-1	+1	%
			$T_A = \text{FT}$	-2	—	
G_{V-TC}	Voltage gain temperature co-efficient		$T_A = \text{FT}$	100	—	ppm/K
Z_{OUT}	Output impedance	ZXCT1084Q/85Q/86Q/87Q	—	125	—	k Ω
V_{OUTH}	Output relative to common mode, V_{S-}	ZXCT1082Q/83Q	$V_{LOAD} - 1$	$V_{LOAD} - 0.8$	—	V
		ZXCT1084Q/85Q/86Q/87Q	$V_{S-} - 1$	$V_{S-} - 0.8$	—	

- Notes:
- For the ZXCT1082/83 $V_{\text{SENSE}} = "V_{\text{SUPPLY}}" - "V_{\text{LOAD}}"$ where V_{LOAD} is the load voltage or the lower potential side of the sense resistor. For the ZXCT1083/84/85/86 $V_{\text{SENSE}} = "V_{S+}" - "V_{S-}"$
 - V_{IO} is extrapolated from measurements for the gain-error test.
 - For $V_{\text{SENSE}} > 10\text{mV}$, the internal voltage-current converter is fully linear. This enables a true offset to be defined and used.
 - Gain or transconductance error is calculated by applying two values of V_{SENSE} and calculating the error of the slope vs. the ideal.

ZXCT1082Q/83Q/84Q/85Q/86Q/87Q

Electrical Characteristics (cont.)

Test Conditions $T_A = +25^\circ\text{C}$, $V_{S+} = 12\text{V}$, $V_{CC} = 5\text{V}$, $V_{SENSE}^1 = 100\text{mV}$, ZXCT1082Q/83Q $R_{GT} = 5\text{k}\Omega$, $R_G = 125\text{k}\Omega$; unless otherwise stated. (FT = -40°C to $+125^\circ\text{C}$)

Symbol	Parameter	Conditions	Min	Typ	Max	Units	
AC characteristics							
BW	-3dB Small Signal Bandwidth	$V_{SENSE(AC)} = 10\text{mV}_{PP}$ (Note 5)	G = 25	—	500	—	kHz
			G = 50	—	200	—	
$t_{s(0.1\%)}$	Settling time (0.1%)	$V_{SENSE} = 50\text{mV}$ to 300mV step $V_{SENSE} = 50\text{mV}$ to 200mV step	G = 25	—	5	—	μs
			G = 50	—	7	—	
i_{N-OUT}	Output noise current density	f = 1kHz	ZXCT1082Q/83Q	—	12	—	$\text{pA}/\sqrt{\text{Hz}}$
		f = 10kHz		—	10	—	
	Total output noise current	f = 0.1Hz to 100kHz		—	3	—	nA_{RMS}
V_{N-OUT}	Output noise voltage density	f = 1kHz	ZXCT1084Q/85Q	—	1.5	—	$\mu\text{V}/\sqrt{\text{Hz}}$
			ZXCT1086Q/87Q	—	2.9	—	
		f = 10kHz	ZXCT1084Q/85Q	—	1.2	—	
			ZXCT1086Q/87Q	—	2.3	—	
	Total output noise voltage	f = 0.1Hz to 100kHz	ZXCT1084Q/85Q	—	390	—	μV_{RMS}
ZXCT1086Q/87Q	—	730	—	—	—		
Power Supply							
I_{CC}	V_{CC} Supply current	$V_{SENSE} = 0\text{V}$	—	—	0.6	—	μA
			$T_A = FT$	—	—	2	—
PSRR (Note 10)	V_{CC} Supply rejection ratio	ZXCT1083Q/85Q: $V_{SENSE} = 60\text{mV}$; $V_{CC} = 2.7\text{V}$ to 40V	—	80	100	—	dB
		$T_A = FT$	—	75	—	—	
		ZXCT1087Q: $V_{SENSE} = 30\text{mV}$; $V_{CC} = 2.7\text{V}$ to 40V	—	80	100	—	
		$T_A = FT$	—	75	—	—	
		ZXCT1082Q/84Q: $V_{SENSE} = 60\text{mV}$; $V_{CC} = 2.7\text{V}$ to 60V	—	80	100	—	
$T_A = FT$	—	75	—	—			
CMRR (Note 10)	Common-mode sense rejection ratio	ZXCT1083Q/85Q: $V_{SENSE} = 60\text{mV}$; $V_{S+} = 2.7\text{V}$ to 40V	—	80	100	—	dB
		$T_A = FT$	—	80	—	—	
		ZXCT1087Q: $V_{SENSE} = 30\text{mV}$; $V_{S+} = 2.7\text{V}$ to 40V	—	80	100	—	
		$T_A = FT$	—	80	—	—	
		ZXCT1082Q/84Q: $V_{SENSE} = 60\text{mV}$; $V_{S+} = 2.7\text{V}$ to 60V	—	80	100	—	
$T_A = FT$	—	80	—	—			
ZXCT1086Q: $V_{SENSE} = 30\text{mV}$; $V_{S+} = 2.7\text{V}$ to 60V	—	80	100	—			
$T_A = FT$	—	80	—	—			

Note: 10. Measured relative to input

ZXCT1082Q/83Q/84Q/85Q/86Q/87Q

Typical Characteristics (@ $V_{S+} = 12V$, $V_{CC} = 5V$, $V_{SENSE} = 100mV$, $R_{GT} = 5k\Omega$, $R_G = 125k\Omega$, $T_A = +25^\circ C$, unless otherwise stated.)

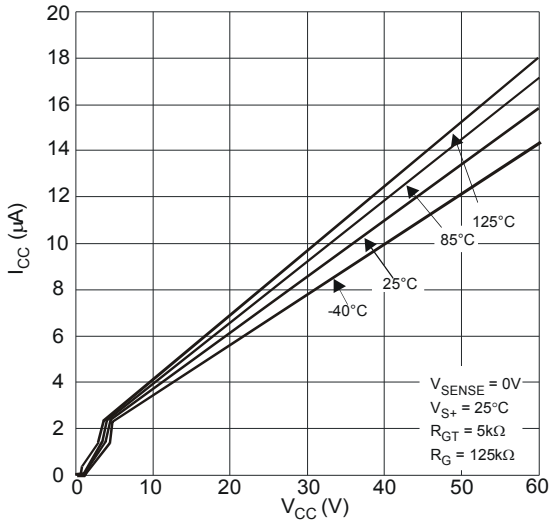

Supply Current vs. Supply Voltage

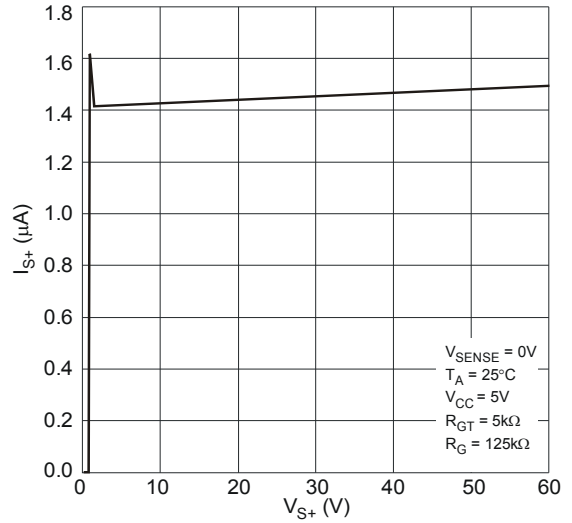

S+ Input Current vs. S+ Voltage

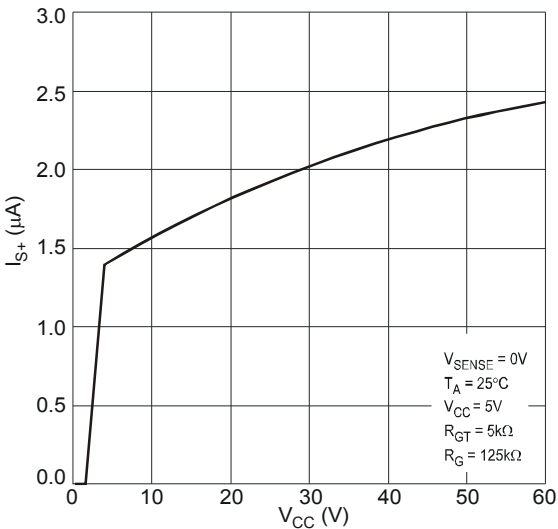

I_{S+} Input Current vs. V_{CC}

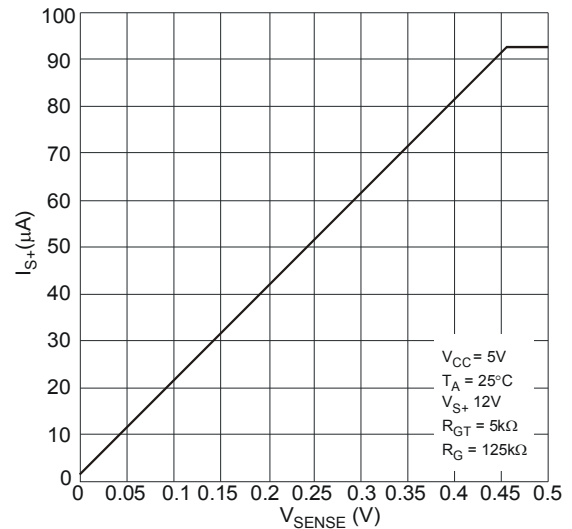

I_{S+} Input Current vs. V_{SENSE}

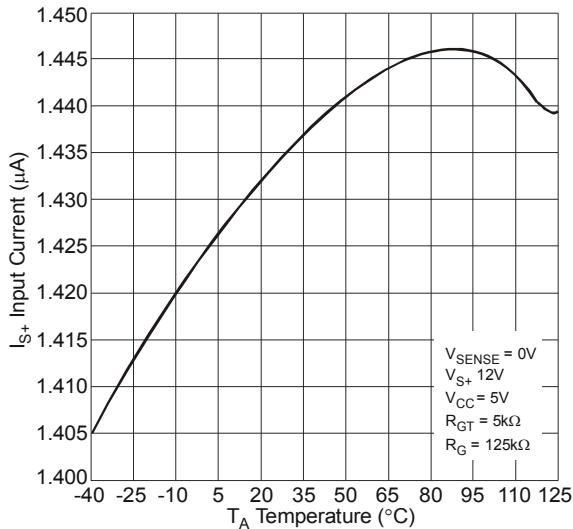

I_{S+} Input Current vs. Ambient Temperature

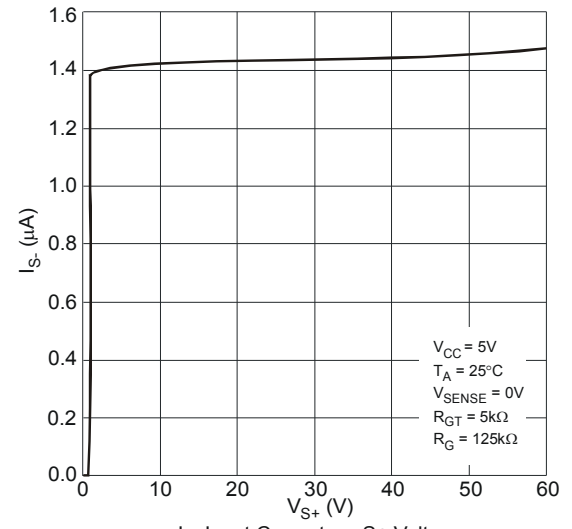

I_{S-} Input Current vs. S+ Voltage

ZXCT1082Q/83Q/84Q/85Q/86Q/87Q

Typical Characteristics (cont.) (@ $V_{S+} = 12V$, $V_{CC} = 5V$, $V_{SENSE} = 100mV$, $R_{GT} = 5k\Omega$, $R_G = 125k\Omega$, $T_A = +25^\circ C$)

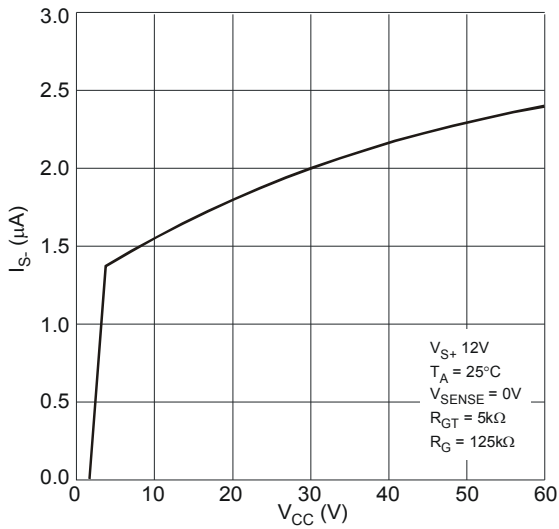

I_{S-} Input Current vs. Supply Voltage

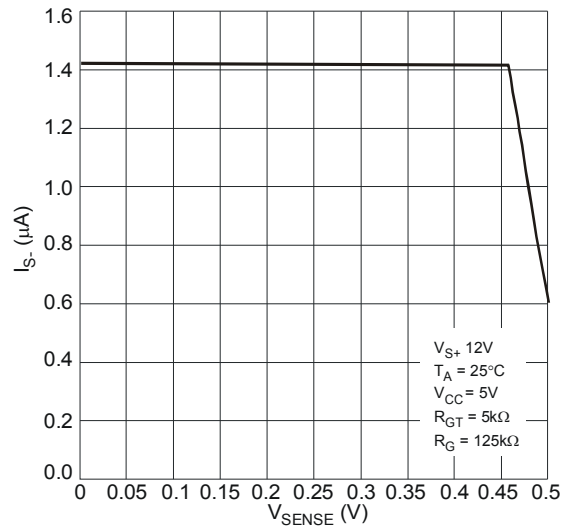

I_{S-} Input Current vs. V_{SENSE} Different Voltage

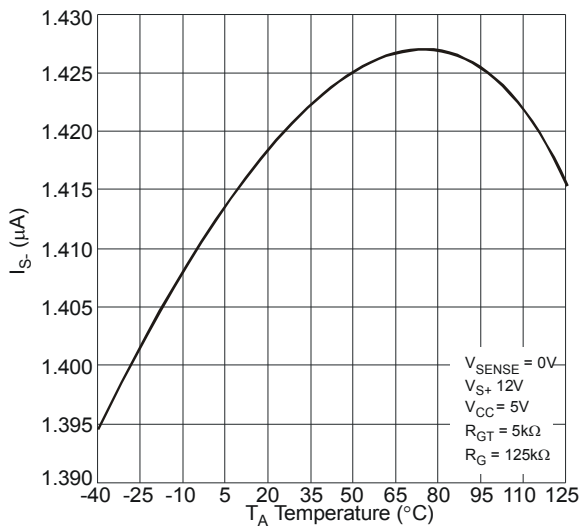

I_{S-} Input Current vs. Ambient Temperature

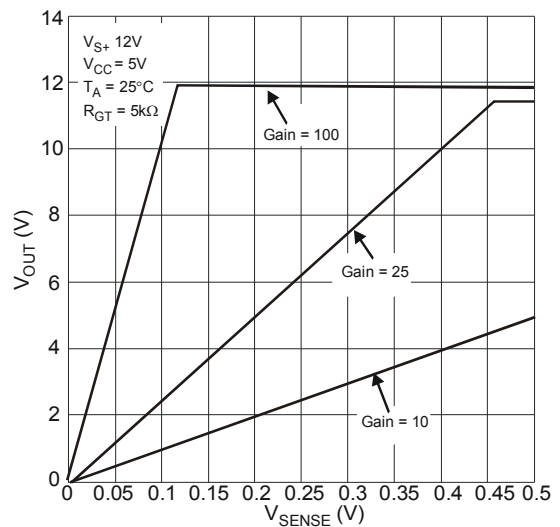

Output Voltage vs. V_{SENSE}

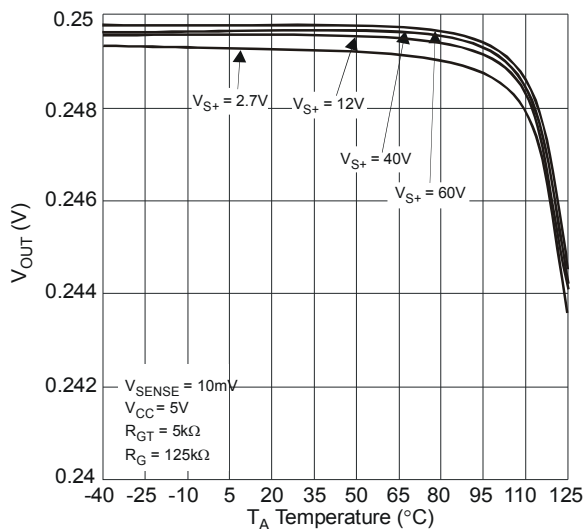

V_{OUT} vs. Ambient Temperature

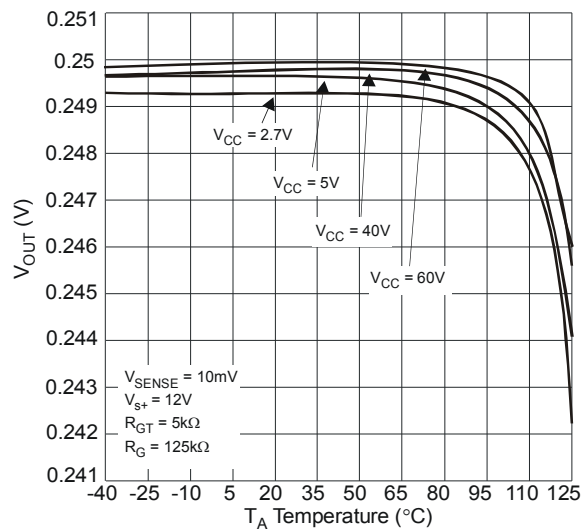

V_{OUT} vs. Ambient Temperature

ZXCT1082Q/83Q/84Q/85Q/86Q/87Q

Typical Characteristics (cont.) (@ $V_{S+} = 12V$, $V_{CC} = 5V$, $V_{SENSE} = 100mV$, $R_{GT} = 5k\Omega$, $R_G = 125k\Omega$, $T_A = +25^\circ C$)

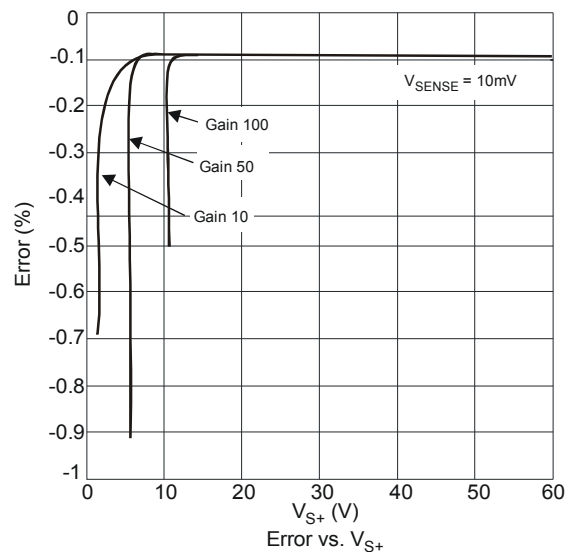
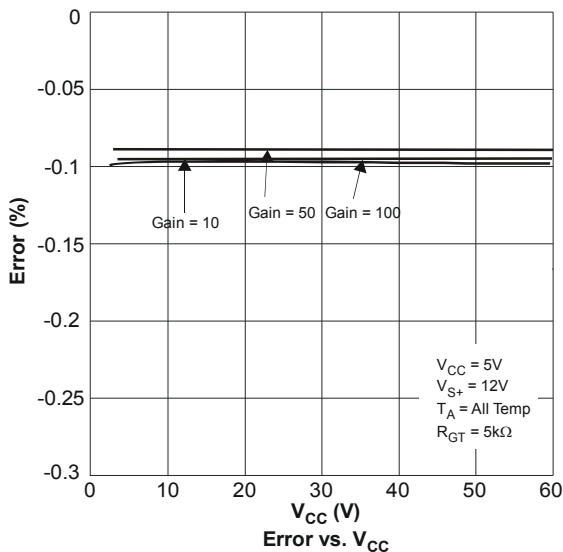
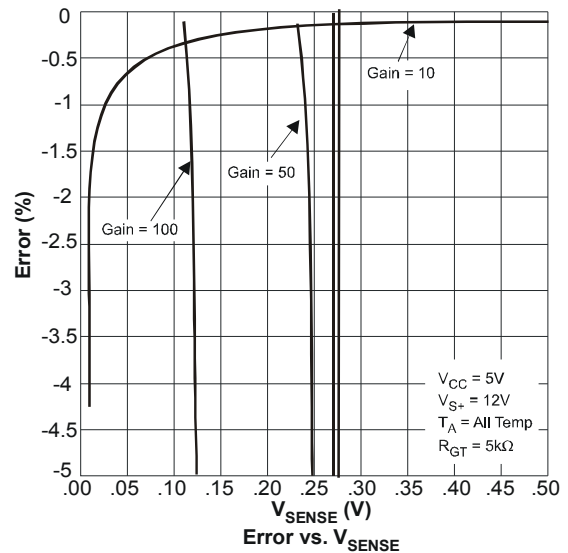
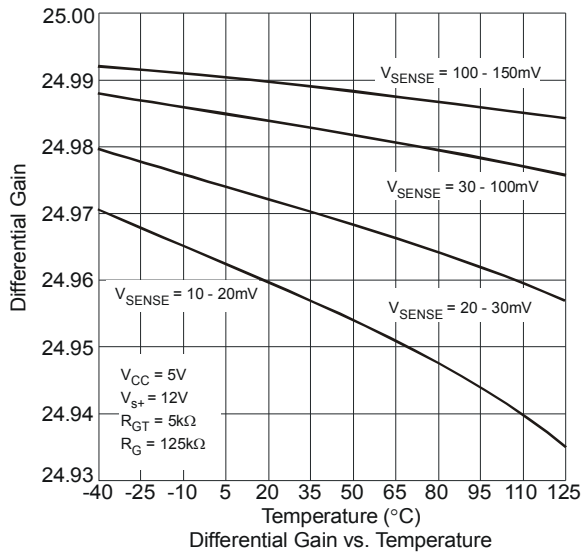
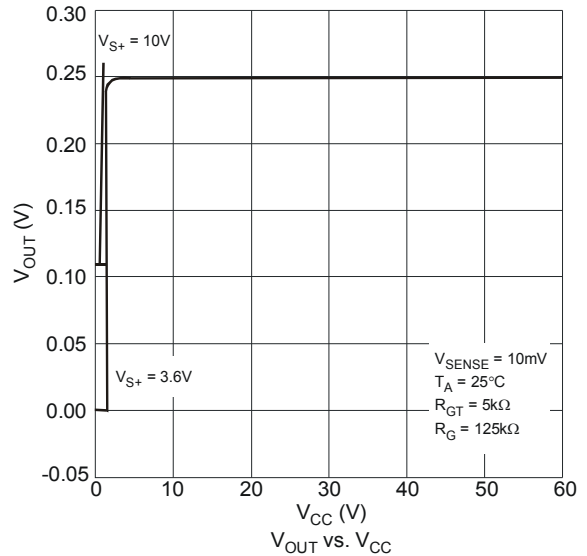
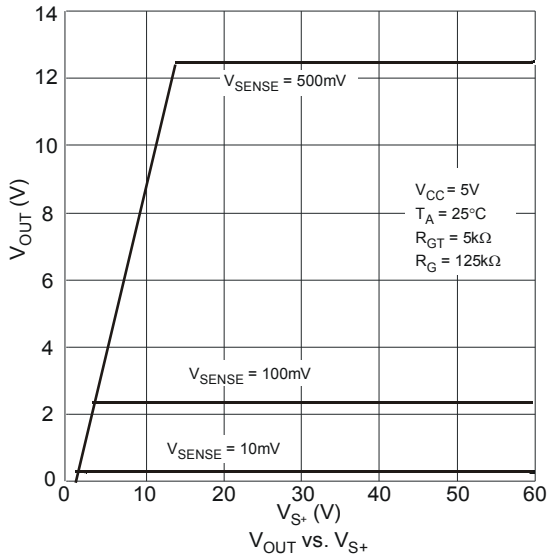

ZXCT1082Q/83Q/84Q/85Q/86Q/87Q

Typical Characteristics (cont.) @ $V_{S+} = 12V$, $V_{CC} = 5V$, $V_{SENSE} = 100mV$, $R_{GT} = 5k\Omega$, $R_G = 125k\Omega$, $T_A = +25^\circ C$

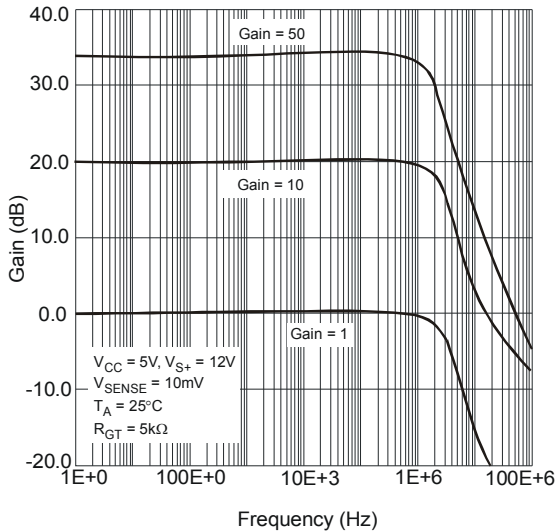

Small Signal Bandwidth vs. Frequency

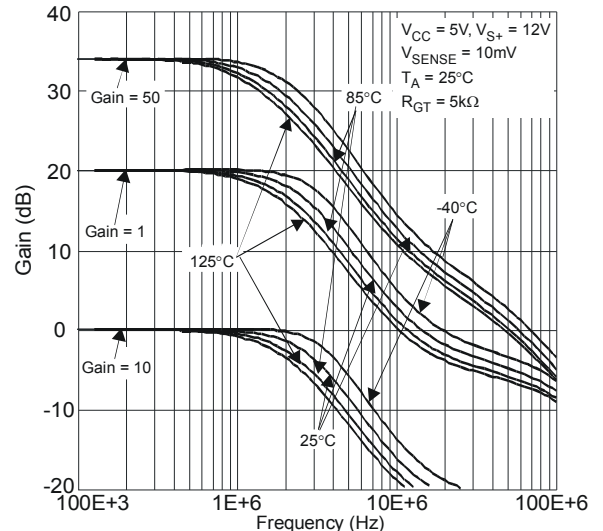

Small Signal Bandwidth vs. Frequency

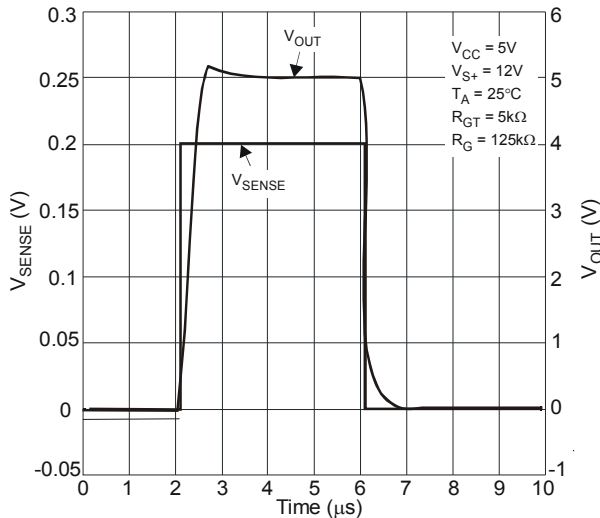

Large Signal Pulse Response

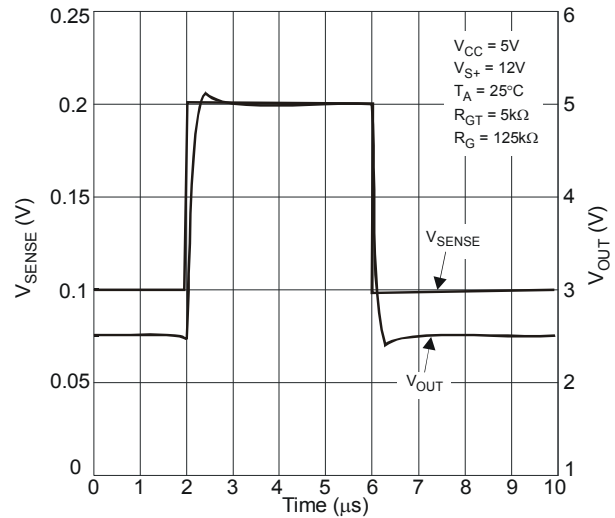

Large Signal Pulse Response

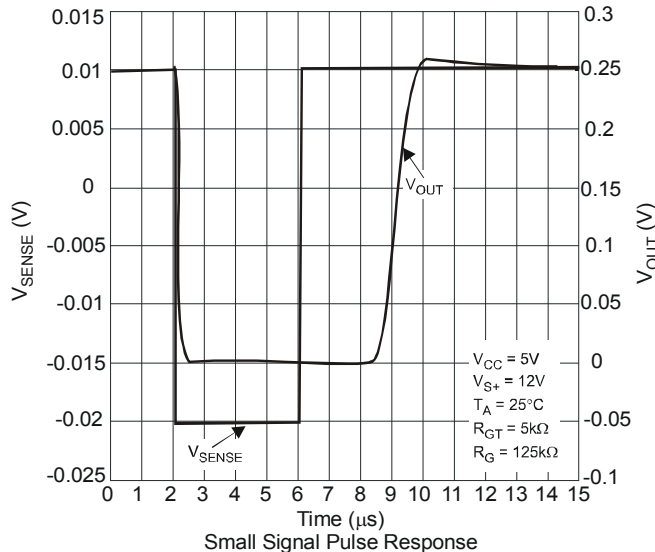

Small Signal Pulse Response

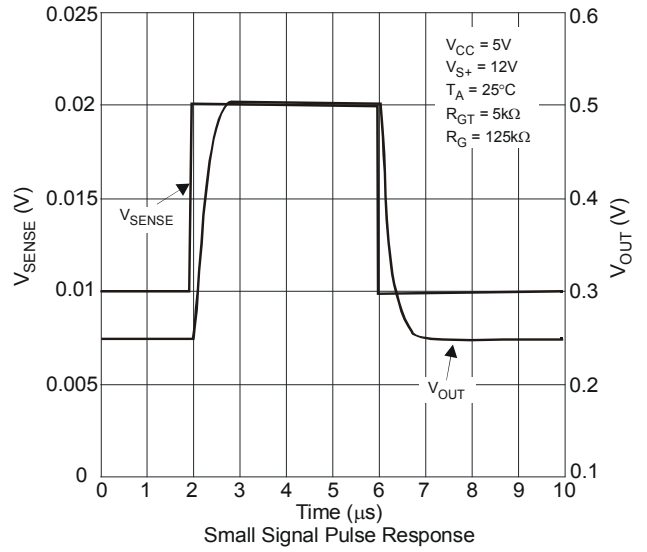

Small Signal Pulse Response

ZXCT1082Q/83Q/84Q/85Q/86Q/87Q

Typical Characteristics (cont.) @ $V_{S+} = 12V$, $V_{CC} = 5V$, $V_{SENSE} = 100mV$, $R_{GT} = 5k\Omega$, $R_G = 125k\Omega$, $T_A = +25^\circ C$

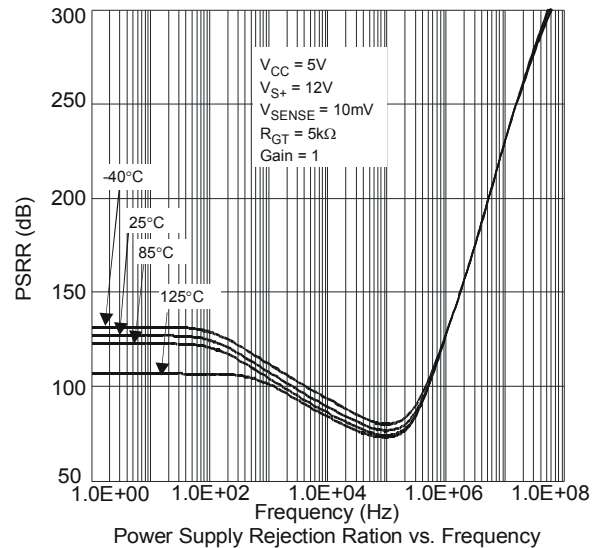
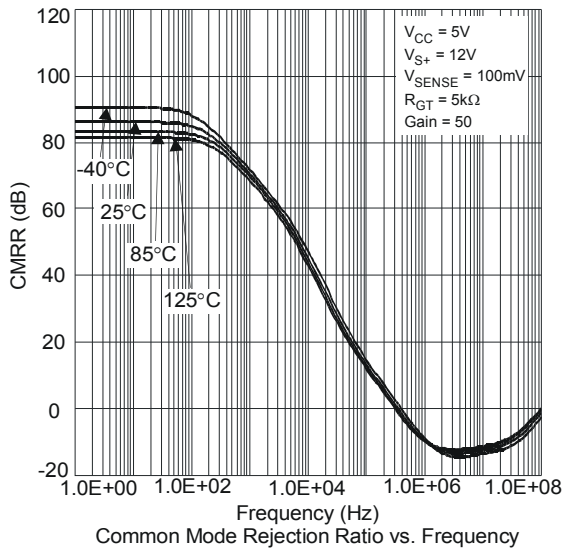
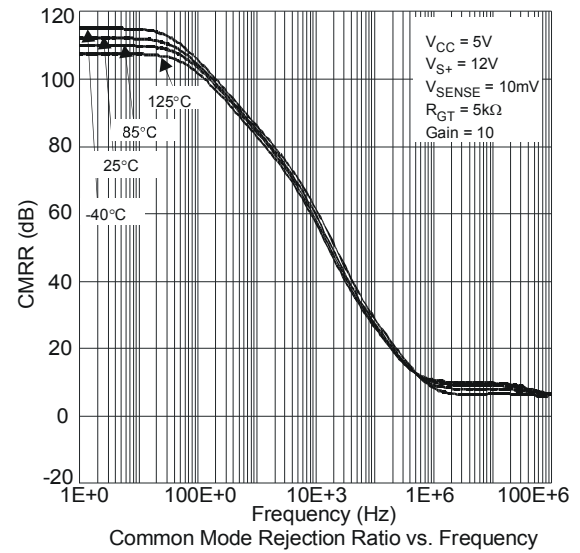
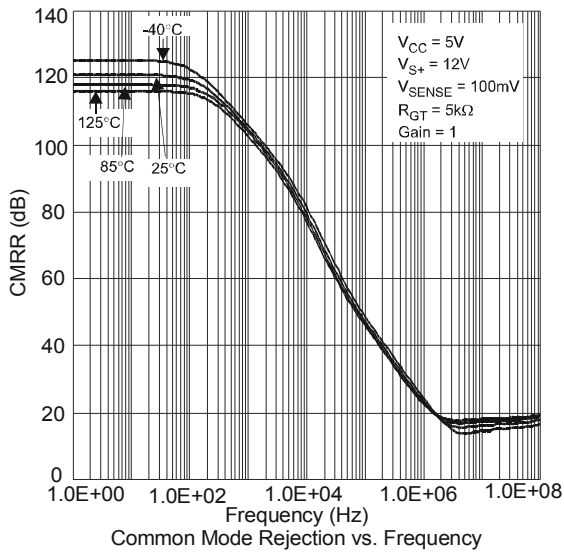
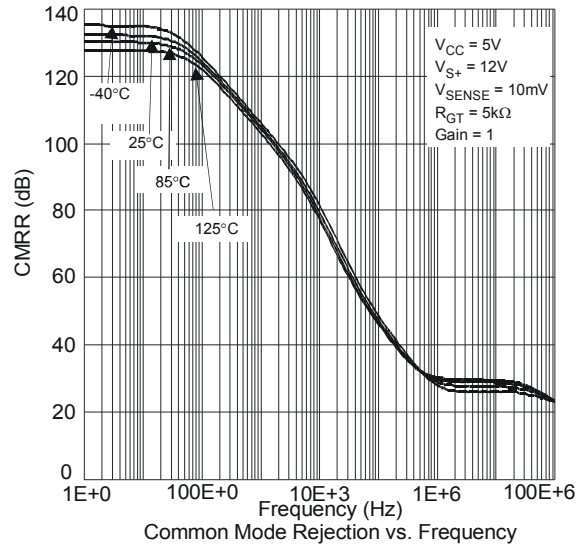
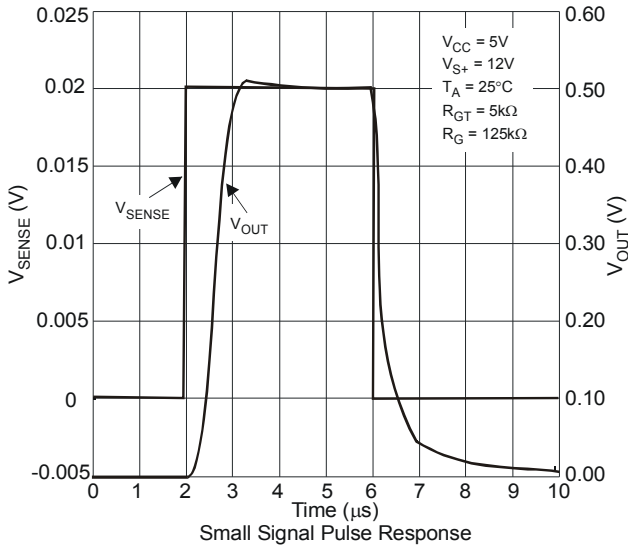

ZXCT1082Q/83Q/84Q/85Q/86Q/87Q

Typical Characteristics (cont.) @ $V_{S+} = 12V$, $V_{CC} = 5V$, $V_{SENSE} = 100mV$, $R_{GT} = 5k\Omega$, $R_G = 125k\Omega$, $T_A = +25^\circ C$

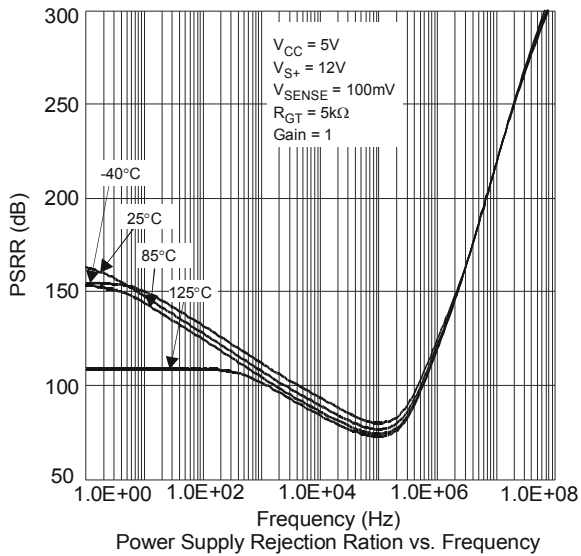

Power Supply Rejection Ratio vs. Frequency

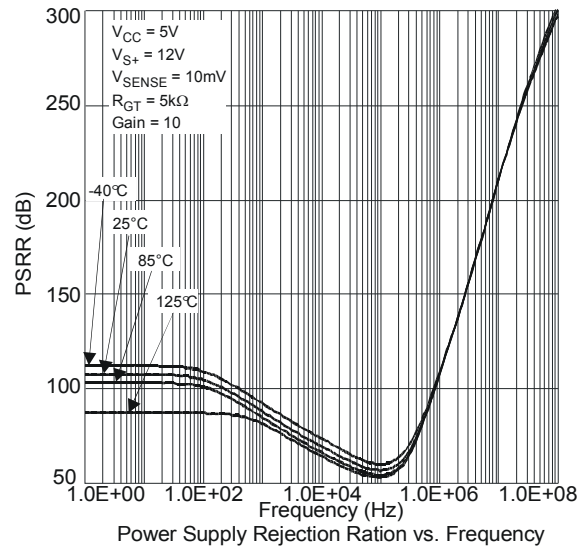

Power Supply Rejection Ratio vs. Frequency

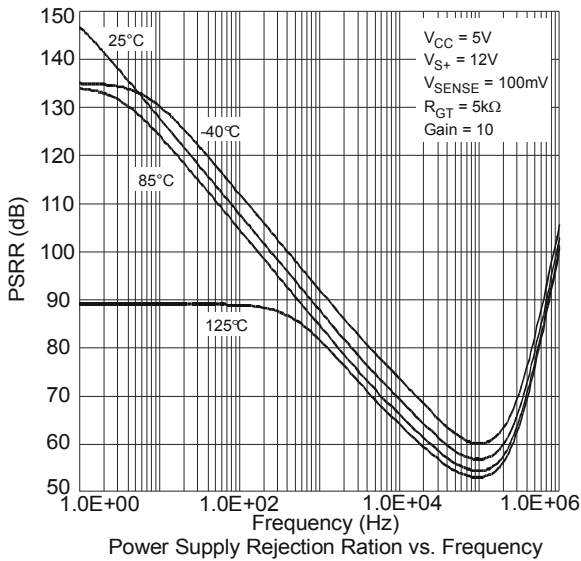

Power Supply Rejection Ratio vs. Frequency

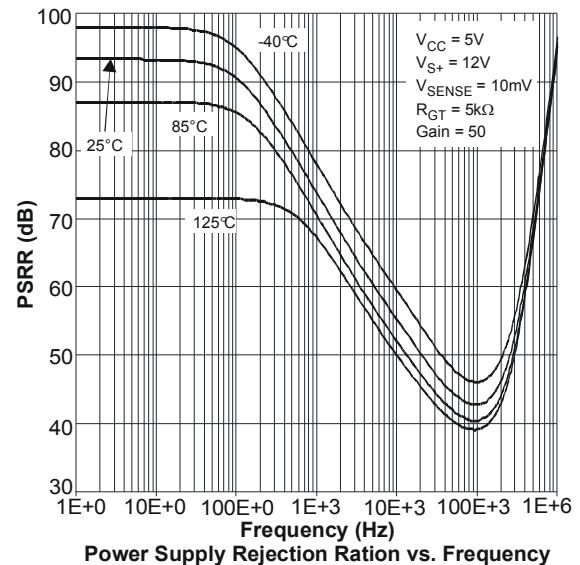

Power Supply Rejection Ratio vs. Frequency

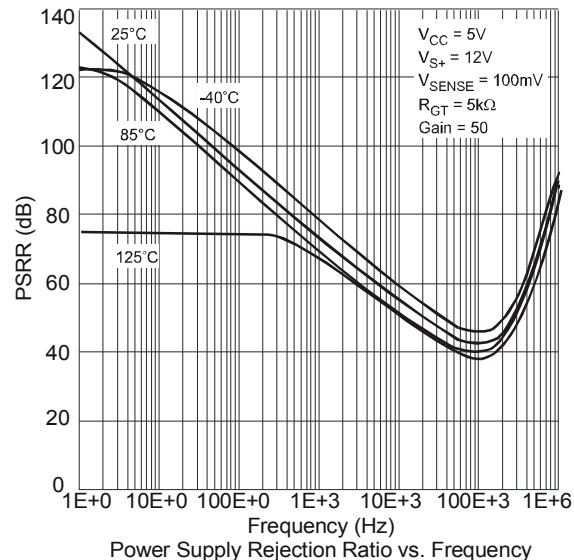

Power Supply Rejection Ratio vs. Frequency

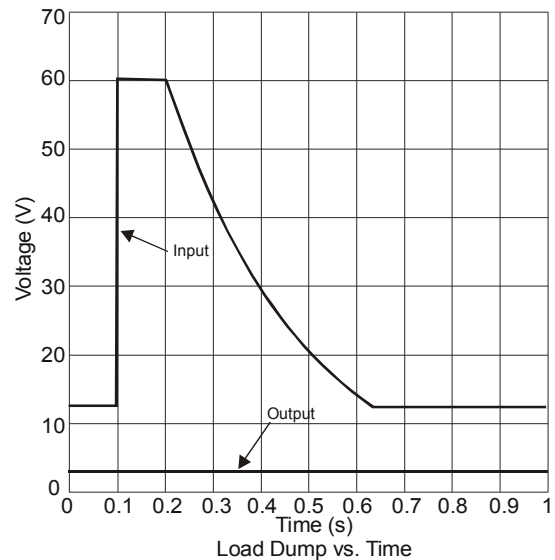

Load Dump vs. Time

ZXCT1082Q/83Q/84Q/85Q/86Q/87Q

Typical Characteristics (cont.) @ $V_{S+} = 12V$, $V_{CC} = 5V$, $V_{SENSE} = 100mV$, $R_{GT} = 5k\Omega$, $R_G = 125k\Omega$, $T_A = +25^\circ C$

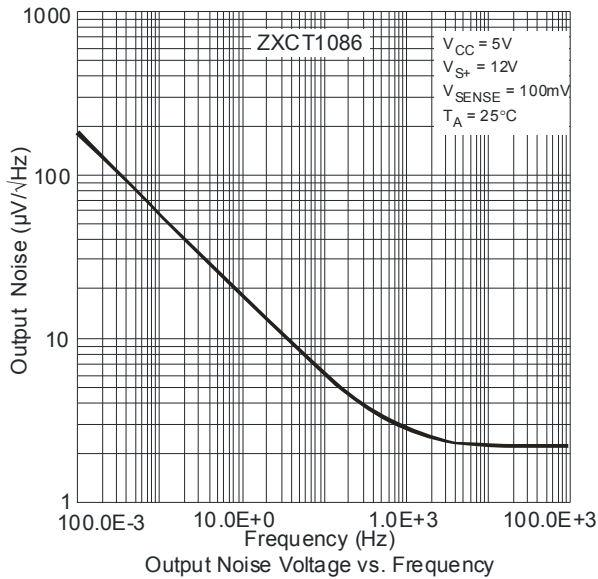
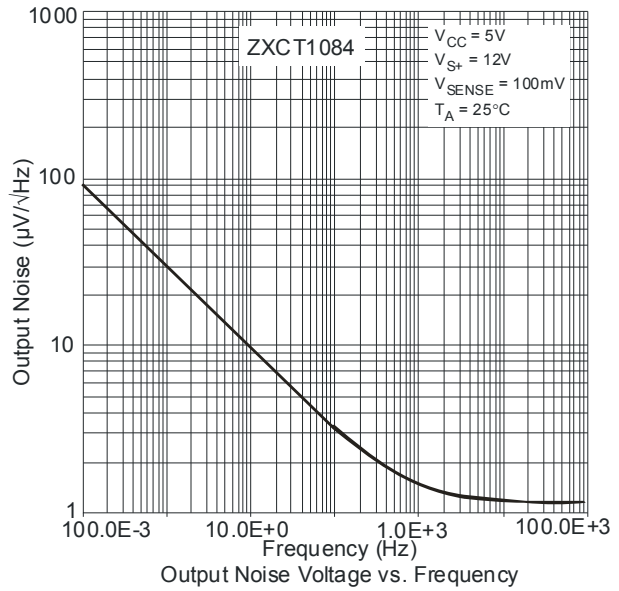
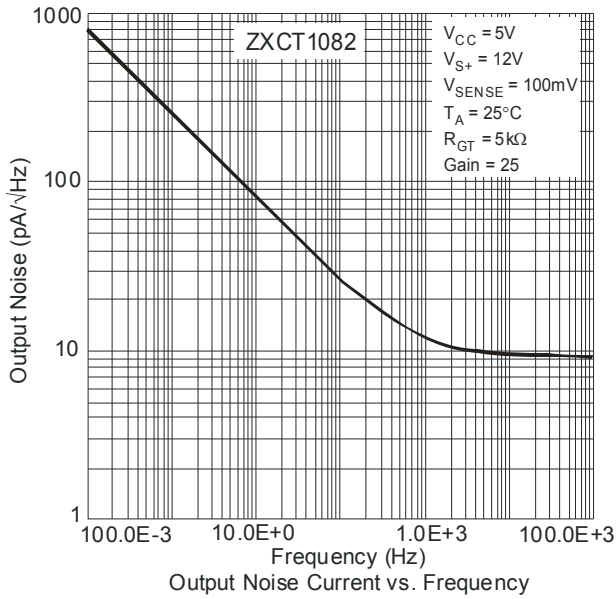

Ordering Information

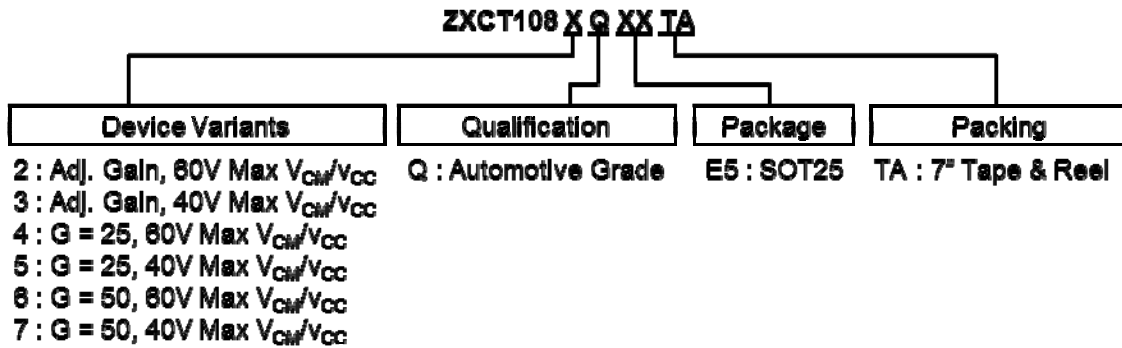

Part Number	Packaging (Note 11)	Package Code	Identification Code	Packing: 7" Tape and Reel			Qualification Grade (Note 12)
				Quantity	Tape width	Part Number Suffix	
ZXCT1082QE5TA	SOT25	E5	1082	3000 Units	8mm	TA	Automotive Grade
ZXCT1083QE5TA	SOT25	E5	1083	3000 Units	8mm	TA	Automotive Grade
ZXCT1084QE5TA	SOT25	E5	1084	3000 Units	8mm	TA	Automotive Grade
ZXCT1085QE5TA	SOT25	E5	1085	3000 Units	8mm	TA	Automotive Grade
ZXCT1086QE5TA	SOT25	E5	1086	3000 Units	8mm	TA	Automotive Grade
ZXCT1087QE5TA	SOT25	E5	1087	3000 Units	8mm	TA	Automotive Grade

Note: 11. Pad layout as shown on Diodes Inc. suggested pad layout document AP02001, which can be found on our website at <http://www.diodes.com/datasheets/ap02001.pdf>

12. ZXCT1082Q/83Q/84Q/85Q/86Q/87Q have been qualified to AEC-Q100 grade 1 and is classified as "Automotive Grade" which supports PPAP documentation. See ZXCT1082/82/84/85/86/87 datasheet for commercial qualified version.

Marking Information

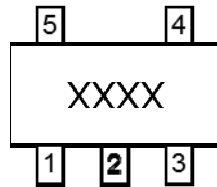

: Identification code : XXXX

Package Outline Dimensions

Please see AP02002 at <http://www.diodes.com/datasheets/ap02002.pdf> for latest version.

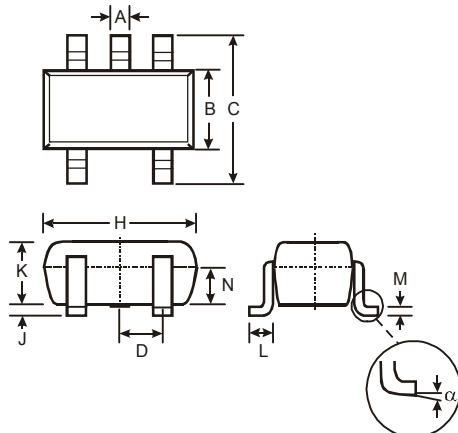

SOT25			
Dim	Min	Max	Typ
A	0.35	0.50	0.38
B	1.50	1.70	1.60
C	2.70	3.00	2.80
D	—	—	0.95
H	2.90	3.10	3.00
J	0.013	0.10	0.05
K	1.00	1.30	1.10
L	0.35	0.55	0.40
M	0.10	0.20	0.15
N	0.70	0.80	0.75
α	0°	8°	—
All Dimensions in mm			

Suggested Pad Layout

Please see AP02001 at <http://www.diodes.com/datasheets/ap02001.pdf> for the latest version.

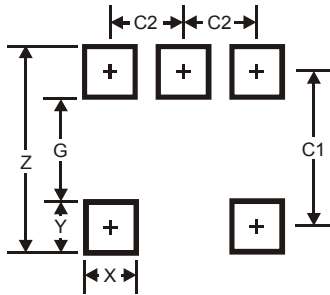

Dimensions	Value (in mm)
Z	3.20
G	1.60
X	0.55
Y	0.80
C1	2.40
C2	0.95

IMPORTANT NOTICE

DIODES INCORPORATED MAKES NO WARRANTY OF ANY KIND, EXPRESS OR IMPLIED, WITH REGARDS TO THIS DOCUMENT, INCLUDING, BUT NOT LIMITED TO, THE IMPLIED WARRANTIES OF MERCHANTABILITY AND FITNESS FOR A PARTICULAR PURPOSE (AND THEIR EQUIVALENTS UNDER THE LAWS OF ANY JURISDICTION).

Diodes Incorporated and its subsidiaries reserve the right to make modifications, enhancements, improvements, corrections or other changes without further notice to this document and any product described herein. Diodes Incorporated does not assume any liability arising out of the application or use of this document or any product described herein; neither does Diodes Incorporated convey any license under its patent or trademark rights, nor the rights of others. Any Customer or user of this document or products described herein in such applications shall assume all risks of such use and will agree to hold Diodes Incorporated and all the companies whose products are represented on Diodes Incorporated website, harmless against all damages.

Diodes Incorporated does not warrant or accept any liability whatsoever in respect of any products purchased through unauthorized sales channel.

Should Customers purchase or use Diodes Incorporated products for any unintended or unauthorized application, Customers shall indemnify and hold Diodes Incorporated and its representatives harmless against all claims, damages, expenses, and attorney fees arising out of, directly or indirectly, any claim of personal injury or death associated with such unintended or unauthorized application.

Products described herein may be covered by one or more United States, international or foreign patents pending. Product names and markings noted herein may also be covered by one or more United States, international or foreign trademarks.

This document is written in English but may be translated into multiple languages for reference. Only the English version of this document is the final and determinative format released by Diodes Incorporated.

LIFE SUPPORT

Diodes Incorporated products are specifically not authorized for use as critical components in life support devices or systems without the express written approval of the Chief Executive Officer of Diodes Incorporated. As used herein:

A. Life support devices or systems are devices or systems which:

1. are intended to implant into the body, or
2. support or sustain life and whose failure to perform when properly used in accordance with instructions for use provided in the labeling can be reasonably expected to result in significant injury to the user.

B. A critical component is any component in a life support device or system whose failure to perform can be reasonably expected to cause the failure of the life support device or to affect its safety or effectiveness.

Customers represent that they have all necessary expertise in the safety and regulatory ramifications of their life support devices or systems, and acknowledge and agree that they are solely responsible for all legal, regulatory and safety-related requirements concerning their products and any use of Diodes Incorporated products in such safety-critical, life support devices or systems, notwithstanding any devices- or systems-related information or support that may be provided by Diodes Incorporated. Further, Customers must fully indemnify Diodes Incorporated and its representatives against any damages arising out of the use of Diodes Incorporated products in such safety-critical, life support devices or systems.

Copyright © 2014, Diodes Incorporated

www.diodes.com

Компания «Life Electronics» занимается поставками электронных компонентов импортного и отечественного производства от производителей и со складов крупных дистрибьюторов Европы, Америки и Азии.

С конца 2013 года компания активно расширяет линейку поставок компонентов по направлению коаксиальный кабель, кварцевые генераторы и конденсаторы (керамические, пленочные, электролитические), за счёт заключения дистрибьюторских договоров

Мы предлагаем:

- Конкурентоспособные цены и скидки постоянным клиентам.
- Специальные условия для постоянных клиентов.
- Подбор аналогов.
- Поставку компонентов в любых объемах, удовлетворяющих вашим потребностям.
- Приемлемые сроки поставки, возможна ускоренная поставка.
- Доставку товара в любую точку России и стран СНГ.
- Комплексную поставку.
- Работу по проектам и поставку образцов.
- Формирование склада под заказчика.
- Сертификаты соответствия на поставляемую продукцию (по желанию клиента).
- Тестирование поставляемой продукции.
- Поставку компонентов, требующих военную и космическую приемку.
- Входной контроль качества.
- Наличие сертификата ISO.

В составе нашей компании организован Конструкторский отдел, призванный помогать разработчикам, и инженерам.

Конструкторский отдел помогает осуществить:

- Регистрацию проекта у производителя компонентов.
- Техническую поддержку проекта.
- Защиту от снятия компонента с производства.
- Оценку стоимости проекта по компонентам.
- Изготовление тестовой платы монтаж и пусконаладочные работы.



Тел: +7 (812) 336 43 04 (многоканальный)
Email: org@lifeelectronics.ru