

The S-8241 Series is a series of lithium ion/lithium polymer rechargeable battery protection ICs incorporating high-accuracy voltage detection circuits and delay circuits.

These ICs are suitable for protection of 1-cell lithium ion/lithium polymer rechargeable battery packs from overcharge, overdischarge and overcurrent.

#### ■ Features

- (1) Internal high-accuracy voltage detection circuit
  - Overcharge detection voltage: 3.9 V to 4.4 V (5 mV-step) Accuracy of  $\pm 25$  mV (+25°C) and  $\pm 30$  mV (-5 to +55°C)
  - Overcharge release voltage: 3.8 V to 4.4 V\*<sup>1</sup> Accuracy of  $\pm 50$  mV
  - Overdischarge detection voltage: 2.0 V to 3.0 V (100 mV-step) Accuracy of  $\pm 80$  mV
  - Overdischarge release voltage: 2.0 V to 3.4 V\*<sup>2</sup> Accuracy of  $\pm 100$  mV
  - Overcurrent 1 detection voltage: 0.05 V to 0.32 V (5 mV-step) Accuracy of  $\pm 20$  mV
  - Overcurrent 2 detection voltage: 0.5 V (fixed) Accuracy of  $\pm 100$  mV
- (2) A high voltage withstand device is used for charger connection pins (VM and CO pins: Absolute maximum rating = 26 V)
- (3) Delay times (overcharge:  $t_{CU}$ ; overdischarge:  $t_{DL}$ ; overcurrent 1:  $t_{IOV1}$ ; overcurrent 2:  $t_{IOV2}$ ) are generated by an internal circuit. (External capacitors are unnecessary.) Accuracy of  $\pm 30\%$
- (4) Internal three-step overcurrent detection circuit (overcurrent 1, overcurrent 2, and load short-circuiting)
- (5) Either the 0 V battery charging function or 0 V battery charge inhibiting function can be selected.
- (6) Products with and without a power-down function can be selected.
- (7) Charger detection function and abnormal charge current detection function
  - The overdischarge hysteresis is released by detecting a negative VM pin voltage (typ. -1.3 V) (Charger detection function).
  - If the output voltage at DO pin is high and the VM pin voltage becomes equal to or lower than the charger detection voltage (typ. -1.3 V), the output voltage at CO pin goes low (Abnormal charge current detection function).
- (8) Low current consumption
  - Operation: 3.0  $\mu$ A typ. 5.0  $\mu$ A max.
  - Power-down mode: 0.1  $\mu$ A max.
- (9) Wide operation temperature range: -40°C to +85°C
- (10) Lead-free, Sn 100%, halogen-free<sup>3</sup>

\*1. Overcharge release voltage = Overcharge detection voltage - Overcharge hysteresis

The overcharge hysteresis can be selected in the range 0.0 V, or 0.1 V to 0.4 V in 50 mV steps. (However, selection "Overcharge release voltage < 3.8 V" is enabled.)

\*2. Overdischarge release voltage = Overdischarge detection voltage + Overdischarge hysteresis

The overdischarge hysteresis can be selected in the range 0.0 V to 0.7 V in 100 mV steps. (However, selection "Overdischarge release voltage > 3.4 V" is enabled.)

\*3. Refer to "■ Product Name Structure" for details.

#### ■ Applications

- Lithium-ion rechargeable battery pack
- Lithium-polymer rechargeable battery pack

#### ■ Packages

- SOT-23-5
- SNT-6A

■ **Block Diagram**



**Remark** The diodes in the IC are parasitic diodes.

**Figure 1**

NOT RECOMMENDED FOR NEW DESIGN

■ Product Name Structure

1. Product Name



\*1. Refer to the tape specifications.

\*2. Refer to the "3. Product Name List".

2. Package

Package name	Drawing code			
	Package	Tape	Reel	Land
SOT-23-5	MP005-A-P-SD	MP005-A-C-SD	MP005-A-R-SD	—
SNT-6A	PG006-A-P-SD	PG006-A-C-SD	PG006-A-R-SD	PG006-A-L-SD

**3. Product Name List**

**(1) SOT-23-5**

**Table 1 (1 / 2)**

Product Name	Over-charge detection voltage [V <sub>CU</sub> ]	Over-charge release voltage [V <sub>CL</sub> ]	Over-discharge detection voltage [V <sub>DL</sub> ]	Over-discharge release voltage [V <sub>DU</sub> ]	Over-current 1 detection voltage [V <sub>IOV1</sub> ]	0 V battery charging function	Delay time combination*1	Power down function
S-8241ABAMC-GBAT2x	4.275 V	4.075 V	2.30 V	2.90 V	0.100 V	Unavailable	(1)	Yes
S-8241ABBMC-GBBT2x	4.280 V	3.980 V	2.30 V	2.40 V	0.125 V	Available	(2)	Yes
S-8241ABCMC-GBCT2x	4.350 V	4.100 V	2.30 V	2.80 V	0.075 V	Unavailable	(1)	Yes
S-8241ABDMC-GBDT2x	4.275 V	4.175 V	2.30 V	2.40 V	0.100 V	Available	(1)	Yes
S-8241ABEMC-GBET2x	4.295 V	4.095 V	2.30 V	3.00 V	0.200 V	Unavailable	(1)	Yes
S-8241ABFMC-GBFT2x	4.325 V	4.075 V	2.50 V	2.90 V	0.100 V	Unavailable	(1)	Yes
S-8241ABGMC-GBGT2x	4.200 V	4.100 V	2.30 V	3.00 V	0.100 V	Unavailable	(1)	Yes
S-8241ABHMC-GBHT2x	4.325 V	4.125 V	2.30 V	2.30 V	0.100 V	Available	(1)	Yes
S-8241ABIMC-GBIT2x	4.280 V	4.080 V	2.30 V	2.30 V	0.160 V	Unavailable	(1)	Yes
S-8241ABKMC-GBKT2x	4.325 V	4.075 V	2.50 V	2.90 V	0.150 V	Unavailable	(1)	Yes
S-8241ABLMC-GBLT2x	4.320 V	4.070 V	2.50 V	2.90 V	0.100 V	Unavailable	(1)	Yes
S-8241ABOMC-GBOT2x	4.350 V	4.150 V	2.30 V	3.00 V	0.150 V	Available	(2)	Yes
S-8241ABPMC-GBPT2x	4.350 V	4.150 V	2.30 V	3.00 V	0.200 V	Available	(2)	Yes
S-8241ABQMC-GBQT2x	4.280 V	4.080 V	2.30 V	2.30 V	0.130 V	Unavailable	(1)	Yes
S-8241ABRMC-GBRT2x	4.325 V	4.075 V	2.50 V	2.90 V	0.100 V	Unavailable	(4)	Yes
S-8241ABTMC-GBTT2x	4.300 V	4.100 V	2.30 V	2.30 V	0.100 V	Available	(1)	Yes
S-8241ABUMC-GBUT2x	4.200 V	4.100 V	2.30 V	2.30 V	0.150 V	Unavailable	(1)	Yes
S-8241ABVMC-GBVT2x	4.295 V	4.095 V	2.30 V	2.30 V	0.130 V	Available	(1)	Yes
S-8241ABWMC-GBWT2x	4.280 V	4.080 V	2.30 V	2.30 V	0.130 V	Unavailable	(3)	Yes
S-8241ABXMC-GBXT2x	4.350 V	4.000 V	2.60 V	3.30 V	0.200 V	Unavailable	(1)	Yes
S-8241ABYMC-GBYT2x	4.220 V	4.220 V	2.30 V	2.30 V	0.200 V	Available	(3)	Yes
S-8241ACAMC-GCAT2x	4.280 V	4.080 V	2.30 V	2.30 V	0.200 V	Available	(1)	Yes
S-8241ACBMC-GCBT2x	4.300 V	4.100 V	2.30 V	2.30 V	0.150 V	Available	(1)	Yes
S-8241ACDMC-GCDT2x	4.275 V	4.075 V	2.30 V	2.30 V	0.100 V	Unavailable	(4)	Yes
S-8241ACEMC-GCET2x	4.295 V	4.095 V	2.30 V	2.30 V	0.080 V	Available	(1)	Yes
S-8241ACFMC-GCFT2x	4.295 V	4.095 V	2.30 V	2.30 V	0.090 V	Available	(1)	Yes
S-8241ACGMC-GCGT2x	4.295 V	4.095 V	2.30 V	2.30 V	0.060 V	Available	(1)	Yes
S-8241ACHMC-GCHT2x	4.280 V	4.080 V	2.60 V	2.60 V	0.200 V	Available	(1)	Yes
S-8241ACIMC-GCIT2x	4.350 V	4.150 V	2.05 V	2.75 V	0.200 V	Available	(2)	Yes
S-8241ACKMC-GCKT2x	4.350 V	4.150 V	2.00 V	2.00 V	0.200 V	Available	(2)	Yes
S-8241ACLMC-GCLT2x	4.200 V	4.200 V	2.50 V	3.00 V	0.100 V	Available	(1)	Yes
S-8241ACNMC-GCNT2x	4.350 V	4.150 V	2.10 V	2.20 V	0.200 V	Available	(2)	Yes
S-8241ACOMC-GCOT2x	4.100 V	3.850 V	2.50 V	2.90 V	0.150 V	Unavailable	(1)	No
S-8241ACPMC-GCPT2x	4.325 V	4.075 V	2.50 V	2.90 V	0.150 V	Unavailable	(1)	No
S-8241ACQMC-GCQT2x	4.275 V	4.175 V	2.30 V	2.40 V	0.100 V	Available	(1)	No
S-8241ACRMC-GCRT2x	4.350 V	4.150 V	2.30 V	3.00 V	0.100 V	Available	(1)	No
S-8241ACSMC-GCST2x	4.180 V	3.930 V	2.50 V	2.90 V	0.150 V	Unavailable	(1)	No
S-8241ACTMC-GCTT2x	4.100 V	4.000 V	2.50 V	2.90 V	0.150 V	Unavailable	(1)	No
S-8241ACUMC-GCUT2x	4.180 V	4.080 V	2.50 V	2.90 V	0.150 V	Unavailable	(1)	No
S-8241ACXMC-GCXT2x	4.275 V	4.075 V	2.50 V	2.90 V	0.150 V	Unavailable	(1)	No
S-8241ACYMC-GCYT2x	4.275 V	4.075 V	2.60 V	2.90 V	0.100 V	Unavailable	(1)	No

# BATTERY PROTECTION IC FOR 1-CELL PACK

## S-8241 Series

Rev.9.2\_00

Table 1 (2 /2)

Product Name	Over-charge detection voltage [V <sub>CU</sub> ]	Over-charge release voltage [V <sub>CL</sub> ]	Over-discharge detection voltage [V <sub>DL</sub> ]	Over-discharge release voltage [V <sub>DU</sub> ]	Over-current 1 detection voltage [V <sub>IOV1</sub> ]	0 V battery charging function	Delay time combination*1	Power down function
S-8241ADAMC-GDAT2x	4.350 V	4.150 V	2.30 V	3.00 V	0.100 V	Available	(1)	Yes
S-8241ADDMC-GDDT2x	4.185 V	4.085 V	2.80 V	2.90 V	0.150 V	Unavailable	(1)	Yes
S-8241ADEMC-GDET2x	4.350 V	4.150 V	2.10 V	2.20 V	0.150 V	Available	(2)	Yes
S-8241ADFMC-GDFT2x	4.350 V	4.150 V	2.10 V	2.10 V	0.150 V	Unavailable	(5)	Yes
S-8241ADGMC-GDGT2x	4.275 V	4.075 V	2.10 V	2.10 V	0.150 V	Unavailable	(5)	Yes
S-8241ADHMC-GDHT2x	4.250 V	4.050 V	2.40 V	2.90 V	0.100 V	Available	(1)	No
S-8241ADIMC-GDIT2x	4.280 V	4.280 V	2.30 V	2.30 V	0.100 V	Unavailable	(5)	Yes
S-8241ADJMC-GDJT2x	4.350 V	4.350 V	2.10 V	2.10 V	0.100 V	Unavailable	(5)	Yes
S-8241ADKMC-GDKT2x	4.275 V	4.275 V	2.10 V	2.10 V	0.100 V	Unavailable	(5)	Yes
S-8241ADLMC-GDLT2x	4.220 V	4.070 V	2.70 V	3.00 V	0.300 V	Available	(1)	Yes
S-8241ADMMC-GDMT2x	4.230 V	4.080 V	2.70 V	3.00 V	0.300 V	Available	(1)	Yes
S-8241ADNMC-GDNT2x	4.250 V	4.100 V	2.70 V	3.00 V	0.300 V	Available	(1)	Yes
S-8241ADOMC-GDOT2x	4.275 V	4.175 V	2.30 V	2.40 V	0.100 V	Unavailable	(1)	No
S-8241ADQMC-GDQT2x	4.250 V	4.100 V	2.00 V	2.70 V	0.150 V	Available	(1)	Yes
S-8241ADSMC-GDST2x	4.250 V	4.150 V	2.00 V	2.70 V	0.150 V	Available	(1)	Yes
S-8241ADTMC-GDTT2x	4.180 V	4.180 V	2.50 V	3.00 V	0.100 V	Available	(1)	Yes
S-8241ADVMC-GDVT2x	3.900 V	3.900 V	2.00 V	2.30 V	0.150 V	Available	(1)	Yes
S-8241ADWMC-GDWT2x	4.100 V	4.000 V	2.50 V	2.70 V	0.300 V	Unavailable	(1)	Yes
S-8241ADXMC-GDXT2x	4.275 V	4.175 V	2.60 V	2.70 V	0.100 V	Available	(1)	No
S-8241ADYMC-GDYT2x	4.100 V	4.000 V	2.00 V	2.20 V	0.300 V	Unavailable	(1)	Yes
S-8241ADZMC-GDZT2x	4.150 V	4.050 V	2.00 V	2.70 V	0.150 V	Available	(1)	Yes
S-8241AEAMC-GEAT2x	4.180 V	4.080 V	2.00 V	2.70 V	0.150 V	Available	(1)	Yes
S-8241AEBMC-GEBT2x	4.280 V	4.130 V	3.00 V	3.20 V	0.150 V	Unavailable	(1)	Yes
S-8241AECMC-GECT2x	4.100 V	4.000 V	2.00 V	2.70 V	0.300 V	Unavailable	(1)	Yes
S-8241AEEMC-GEET2x	4.200 V	4.200 V	2.50 V	3.00 V	0.320 V	Available	(6)	Yes
S-8241AEFMC-GEFT2x	4.200 V	4.100 V	2.00 V	2.70 V	0.150 V	Available	(1)	Yes
S-8241AEHMC-GEHT2x	4.350 V	4.150 V	2.10 V	2.20 V	0.250 V	Unavailable	(2)	Yes
S-8241AEIMC-GEIT2x	4.350 V	4.000 V	2.40 V	3.00 V	0.270 V	Unavailable	(1)	Yes
S-8241AEJMC-GEJT2x	4.350 V	4.000 V	2.40 V	3.00 V	0.300 V	Unavailable	(1)	Yes
S-8241AEKMC-GEKT2x	4.350 V	4.000 V	2.40 V	3.00 V	0.280 V	Unavailable	(1)	Yes
S-8241AEMMC-GEMT2x	4.350 V	4.150 V	2.30 V	3.00 V	0.320 V	Unavailable	(1)	Yes
S-8241AENMC-GENT2x	4.300 V	4.100 V	2.50 V	3.00 V	0.060 V	Available	(2)	Yes
S-8241AEOMC-GEOT2x	4.190 V	4.190 V	2.50 V	3.00 V	0.100 V	Available	(1)	Yes
S-8241AEPMC-GEPT2x	4.215 V	4.115 V	2.80 V	3.00 V	0.100 V	Available	(1)	Yes
S-8241AEQMC-GEQT2x	4.190 V	4.190 V	2.80 V	3.00 V	0.100 V	Available	(1)	Yes
S-8241AETMC-GETT2x	4.220 V	4.070 V	2.70 V	3.00 V	0.200 V	Available	(1)	Yes
S-8241AEUMC-GEUT2x	4.350 V	4.150 V	2.30 V	3.00 V	0.200 V	Unavailable	(2)	Yes
S-8241AEWMC-GEWT2x	4.325 V	4.075 V	2.50 V	2.90 V	0.125 V	Unavailable	(1)	Yes

\*1. Refer to the **Table 3** about the details of the delay time combinations (1) to (7).

- Remark 1.** Please contact our sales office for the products with detection voltage value other than those specified above.
2. x: G or U
  3. Please select products of environmental code = U for Sn 100%, halogen-free products.

(2) SNT-6A

**Table 2**

Product Name	Over-charge detection voltage [V <sub>CU</sub> ]	Over-charge release voltage [V <sub>CL</sub> ]	Over-discharge detection voltage [V <sub>DL</sub> ]	Over-discharge release voltage [V <sub>DU</sub> ]	Over-current 1 detection voltage [V <sub>IOV1</sub> ]	0 V battery charging function	Delay time combination*1	Power down function
S-8241ABDPG-KBDTFx	4.275 V	4.175 V	2.30 V	2.40 V	0.100 V	Available	(1)	Yes
S-8241ABIPG-KBITFx	4.280 V	4.080 V	2.30 V	2.30 V	0.160 V	Unavailable	(1)	Yes
S-8241ABKPG-KBKTFx	4.325 V	4.075 V	2.50 V	2.90 V	0.150 V	Unavailable	(1)	Yes
S-8241ABPPG-KBPTFx	4.350 V	4.150 V	2.30 V	3.00 V	0.200 V	Available	(2)	Yes
S-8241ABSPG-KBSTFx	4.350 V	4.150 V	2.35 V	2.65 V	0.200 V	Available	(2)	Yes
S-8241ABXPG-KBXTFx	4.350 V	4.000 V	2.60 V	3.30 V	0.200 V	Unavailable	(1)	Yes
S-8241ABZPG-KBZTFx	4.275 V	4.075 V	2.30 V	2.40 V	0.140 V	Available	(1)	Yes
S-8241ACFPG-KCFTFx	4.295 V	4.095 V	2.30 V	2.30 V	0.090 V	Available	(1)	Yes
S-8241ACZPG-KCZTFx	4.350 V	4.150 V	2.70 V	2.70 V	0.200 V	Unavailable	(2)	Yes
S-8241ADFPG-KDFTFx	4.350 V	4.150 V	2.10 V	2.10 V	0.150 V	Unavailable	(5)	Yes
S-8241ADHPG-KDHTFx	4.250 V	4.050 V	2.40 V	2.90 V	0.100 V	Available	(1)	No
S-8241ADNPG-KDNTFx	4.250 V	4.100 V	2.70 V	3.00 V	0.300 V	Available	(1)	Yes
S-8241ADRPG-KDRTFx	4.280 V	4.080 V	3.00 V	3.20 V	0.100 V	Available	(1)	Yes
S-8241AEDPG-KEDTFx	4.180 V	3.980 V	2.50 V	2.80 V	0.100 V	Unavailable	(1)	Yes
S-8241AEGPG-KEGTFx	4.000 V	3.900 V	2.35 V	2.65 V	0.220 V	Available	(7)	Yes
S-8241AENPG-KENTFx	4.300 V	4.100 V	2.50 V	3.00 V	0.060 V	Available	(2)	Yes
S-8241AERPG-KERTFx	4.300 V	4.100 V	2.40 V	3.00 V	0.060 V	Available	(2)	Yes
S-8241AESPG-KESTFx	4.350 V	4.150 V	2.70 V	2.70 V	0.200 V	Available	(2)	Yes
S-8241AEVPG-KEVTFx	4.350 V	4.100 V	2.30 V	2.80 V	0.100 V	Unavailable	(5)	Yes
S-8241AEXPG-KEXTFU	4.350 V	4.100 V	2.10 V	2.20 V	0.180 V	Unavailable	(1)	Yes
S-8241AEYPG-KEYTFU	4.350 V	4.100 V	2.10 V	2.20 V	0.190 V	Unavailable	(1)	Yes
S-8241AFAPG-KFATFU	4.350 V	4.100 V	2.10 V	2.20 V	0.200 V	Unavailable	(1)	Yes
S-8241AFBPG-KFBTFU	4.350 V	4.100 V	2.10 V	2.20 V	0.220 V	Unavailable	(1)	Yes

\*1. Refer to the **Table 3** about the details of the delay time combinations (1) to (7).

- Remark 1.** Please contact our sales office for the products with detection voltage value other than those specified above.
2. x: G or U
  3. Please select products of environmental code = U for Sn 100%, halogen-free products.



Table 3

Delay time combination	Overcharge detection delay time [ $t_{CU}$ ]	Overdischarge detection delay time [ $t_{DL}$ ]	Overcurrent 1 detection delay time [ $t_{OV1}$ ]
(1)	1.0 s	125 ms	8 ms
(2)	0.125 s	31 ms	16 ms
(3)	0.25 s	125 ms	8 ms
(4)	2.0 s	125 ms	8 ms
(5)	0.25 s	31 ms	16 ms
(6)	1.0 s	125 ms	16 ms
(7)	0.5 s	125 ms	8 ms

**Remark** The delay times can be changed within the range listed Table 4. For details, please contact our sales office.

Table 4

Delay time	Symbol	Selection range				Remarks
Overcharge detection delay time	$t_{CU}$	0.25 s	0.5 s	<b>1.0 s</b>	2.0 s	Select a value from the left.
Overdischarge detection delay time	$t_{DL}$	31 ms	62.5 ms	<b>125 ms</b>	—	Select a value from the left.
Overcurrent 1 detection delay time	$t_{OV1}$	4 ms	<b>8 ms</b>	<b>16 ms</b>	—	Select a value from the left.

**Remark** The value surrounded by bold lines is the delay time of the standard products.

■ **Pin Configurations**



**Figure 2**

**Table 5**

Pin No.	Symbol	Description
1	VM	Voltage detection pin between VM and VSS (Overcurrent detection pin)
2	VDD	Positive power input pin
3	VSS	Negative power input pin
4	DO	FET gate connection pin for discharge control (CMOS output)
5	CO	FET gate connection pin for charge control (CMOS output)



**Figure 3**

**Table 6**

Pin No.	Symbol	Description
1	NC*1	No connection
2	CO	FET gate connection pin for charge control (CMOS output)
3	DO	FET gate connection pin for discharge control (CMOS output)
4	VSS	Negative power input pin
5	VDD	Positive power input pin
6	VM	Voltage detection pin between VM and VSS (Overcurrent detection pin)

\*1. The NC pin is electrically open.  
 The NC pin can be connected to VDD or VSS.

NOT RECOMMENDED FOR NEW DESIGN



■ **Absolute Maximum Ratings**

**Table 7**

(Ta = 25°C unless otherwise specified)

Item	Symbol	Applicable pin	Rating	Unit	
Input voltage between VDD and VSS	V <sub>DS</sub>	VDD	V <sub>SS</sub> -0.3 to V <sub>SS</sub> +12	V	
VM input pin voltage	V <sub>VM</sub>	VM	V <sub>DD</sub> -26 to V <sub>DD</sub> +0.3	V	
CO output pin voltage	V <sub>CO</sub>	CO	V <sub>VM</sub> -0.3 to V <sub>DD</sub> +0.3	V	
DO output pin voltage	V <sub>DO</sub>	DO	V <sub>SS</sub> -0.3 to V <sub>DD</sub> +0.3	V	
Power dissipation	SOT-23-5 SNT-6A	P <sub>D</sub>	—	250 (When not mounted on board)	mW
				600*1	mW
				400*1	mW
Operation ambient temperature	T <sub>opr</sub>	—	-40 to +85	°C	
Storage temperature	T <sub>stg</sub>	—	-40 to +125	°C	

\*1. When mounted on board  
[Mounted board]

- (1) Board size: 114.3 mm × 76.2 mm × 1.6 mm
- (2) Board name: JEDEC STANDARD51-7

**Caution** The absolute maximum ratings are rated values exceeding which the product could suffer physical damage. These values must therefore not be exceeded under any conditions.



**Figure 4 Power Dissipation of Package (When Mounted on Board)**

■ **Electrical Characteristics**

1. Other than detection delay time (25°C)

Table 8

(Ta = 25°C unless otherwise specified)

Item	Symbol	Condition	Min.	Typ.	Max.	Unit	Test Condition	Test Circuit
<b>DETECTION VOLTAGE</b>								
Overcharge detection voltage V <sub>CU</sub> = 3.9 V to 4.4 V, 5 mV Step	V <sub>CU</sub>	— Ta = -5°C to +55°C*1	V <sub>CU</sub> -0.025 V <sub>CU</sub> -0.030	V <sub>CU</sub> V <sub>CU</sub>	V <sub>CU</sub> +0.025 V <sub>CU</sub> +0.030	V	1	1
Overcharge release voltage V <sub>CU</sub> -V <sub>CL</sub> = 0.0 V to 0.4 V, 50 mV Step	V <sub>CL</sub>	When V <sub>CL</sub> ≠ V <sub>CU</sub> When V <sub>CL</sub> = V <sub>CU</sub>	V <sub>CL</sub> -0.050 V <sub>CL</sub> -0.025	V <sub>CL</sub> V <sub>CL</sub>	V <sub>CL</sub> +0.050 V <sub>CL</sub> +0.025	V	1	1
Overdischarge detection voltage V <sub>DL</sub> = 2.0 V to 3.0 V, 100 mV Step	V <sub>DL</sub>	—	V <sub>DL</sub> -0.080	V <sub>DL</sub>	V <sub>DL</sub> +0.080	V	1	1
Overdischarge release voltage V <sub>DU</sub> -V <sub>DL</sub> = 0.0 V to 0.7 V, 100 mV Step	V <sub>DU</sub>	When V <sub>DU</sub> ≠ V <sub>DL</sub> When V <sub>DU</sub> = V <sub>DL</sub>	V <sub>DU</sub> -0.100 V <sub>DU</sub> -0.080	V <sub>DU</sub> V <sub>DU</sub>	V <sub>DU</sub> +0.100 V <sub>DU</sub> +0.080	V	1	1
Overcurrent 1 detection voltage V <sub>IOV1</sub> = 0.05 V to 0.32 V, 5 mV Step	V <sub>IOV1</sub>	—	V <sub>IOV1</sub> -0.020	V <sub>IOV1</sub>	V <sub>IOV1</sub> +0.020	V	2	1
Overcurrent 2 detection voltage	V <sub>IOV2</sub>	—	0.4	0.5	0.6	V	2	1
Load short-circuiting detection voltage	V <sub>SHORT</sub>	VM voltage based on V <sub>DD</sub>	-1.7	-1.3	-0.9	V	2	1
Charger detection voltage	V <sub>CHA</sub>	—	-2.0	-1.3	-0.6	V	3	1
Overcharge detection voltage temperature factor*1	T <sub>COE1</sub>	Ta = -5°C to +55°C	-0.5	0	0.5	mV/°C	—	—
Overcurrent 1 detection voltage temperature factor*1	T <sub>COE2</sub>	Ta = -5°C to +55°C	-0.1	0	0.1	mV/°C	—	—
<b>INPUT VOLTAGE, OPERATING VOLTAGE</b>								
Input voltage between VDD and VSS	V <sub>DS1</sub>	absolute maximum rating	-0.3	—	12	V	—	—
Input voltage between VDD and VM	V <sub>DS2</sub>	absolute maximum rating	-0.3	—	26	V	—	—
Operating voltage between VDD and VSS	V <sub>DSOP1</sub>	Internal circuit operating voltage	1.5	—	8	V	—	—
Operating voltage between VDD and VM	V <sub>DSOP2</sub>	Internal circuit operating voltage	1.5	—	24	V	—	—
<b>CURRENT CONSUMPTION Power-down function available</b>								
Current consumption during normal operation	I <sub>OPE</sub>	V <sub>DD</sub> = 3.5 V, V <sub>VM</sub> = 0 V	1.0	3.0	5.0	μA	4	1
Current consumption at power down	I <sub>PDN</sub>	V <sub>DD</sub> = V <sub>VM</sub> = 1.5 V	—	—	0.1	μA	4	1
<b>CURRENT CONSUMPTION Power-down function unavailable</b>								
Current consumption during normal operation	I <sub>OPE</sub>	V <sub>DD</sub> = 3.5 V, V <sub>VM</sub> = 0 V	1.0	3.0	5.0	μA	4	1
Overdischarge current consumption	I <sub>OPEd</sub>	V <sub>DD</sub> = V <sub>VM</sub> = 1.5 V	1.0	2.0	3.5	μA	4	1
<b>OUTPUT RESISTANCE</b>								
CO pin H resistance	R <sub>COH</sub>	V <sub>CO</sub> = 3.0 V, V <sub>DD</sub> = 3.5 V, V <sub>VM</sub> = 0 V	0.1	2	10	kΩ	6	1
CO pin L resistance	R <sub>COL</sub>	V <sub>CO</sub> = 0.5 V, V <sub>DD</sub> = 4.5 V, V <sub>VM</sub> = 0 V	150	600	2400	kΩ	6	1
DO pin H resistance	R <sub>DOH</sub>	V <sub>DO</sub> = 3.0 V, V <sub>DD</sub> = 3.5 V, V <sub>VM</sub> = 0 V	0.1	1.3	6.0	kΩ	7	1
DO pin L resistance	R <sub>DOL</sub>	V <sub>DO</sub> = 0.5 V, V <sub>DD</sub> = V <sub>VM</sub> = 1.8 V	0.1	0.5	2.0	kΩ	7	1
<b>VM INTERNAL RESISTANCE</b>								
Internal resistance between VM and VDD	R <sub>VMD</sub>	V <sub>DD</sub> = 1.8 V, V <sub>VM</sub> = 0 V	100	300	900	kΩ	5	1
Internal resistance between VM and VSS	R <sub>VMS</sub>	V <sub>DD</sub> = V <sub>VM</sub> = 3.5 V	50	100	150	kΩ	5	1
<b>0 V BATTERY CHARGING FUNCTION</b> The 0 V battery function is either "0 V battery charging function" or "0 V battery charge inhibiting function" depending upon the product type.								
0 V battery charge starting charger voltage	V <sub>OCHA</sub>	0 V battery charging Available	0.0	0.8	1.5	V	10	1
0 V battery charge inhibiting battery voltage	V <sub>OINH</sub>	0 V battery charging Unavailable	0.6	0.9	1.2	V	11	1

\*1. Since products are not screened at high and low temperatures, the specification for this temperature range is guaranteed by design, not tested in production.

# BATTERY PROTECTION IC FOR 1-CELL PACK S-8241 Series

Rev.9.2\_00

## 2. Other than detection delay time (-40°C to +85°C<sup>\*1</sup>)

Table 9

(Ta = -40°C to +85°C<sup>\*1</sup> unless otherwise specified)

Item	Symbol	Condition	Min.	Typ.	Max.	Unit	Test Condition	Test Circuit
<b>DETECTION VOLTAGE</b>								
Overcharge detection voltage V <sub>CU</sub> = 3.9 V to 4.4 V, 5 mV Step	V <sub>CU</sub>	—	V <sub>CU</sub> -0.055	V <sub>CU</sub>	V <sub>CU</sub> +0.040	V	1	1
Overcharge release voltage V <sub>CU</sub> -V <sub>CL</sub> = 0.0 V to 0.4 V, 50 mV Step	V <sub>CL</sub>	When V <sub>CL</sub> ≠ V <sub>CU</sub> When V <sub>CL</sub> = V <sub>CU</sub>	V <sub>CL</sub> -0.095 V <sub>CL</sub> -0.055	V <sub>CL</sub> V <sub>CL</sub>	V <sub>CL</sub> +0.060 V <sub>CL</sub> +0.040	V	1	1
Overdischarge detection voltage V <sub>DL</sub> = 2.0 V to 3.0 V, 100 mV Step	V <sub>DL</sub>	—	V <sub>DL</sub> -0.120	V <sub>DL</sub>	V <sub>DL</sub> +0.120	V	1	1
Overdischarge release voltage V <sub>DU</sub> -V <sub>DL</sub> = 0.0 V to 0.7 V, 100 mV Step	V <sub>DU</sub>	When V <sub>DU</sub> ≠ V <sub>DL</sub> When V <sub>DU</sub> = V <sub>DL</sub>	V <sub>DU</sub> -0.140 V <sub>DU</sub> -0.120	V <sub>DU</sub> V <sub>DU</sub>	V <sub>DU</sub> +0.140 V <sub>DU</sub> +0.120	V	1	1
Overcurrent 1 detection voltage V <sub>IOV1</sub> = 0.05 V to 0.32 V, 5 mV Step	V <sub>IOV1</sub>	—	V <sub>IOV1</sub> -0.026	V <sub>IOV1</sub>	V <sub>IOV1</sub> +0.026	V	2	1
Overcurrent 2 detection voltage	V <sub>IOV2</sub>	—	0.37	0.5	0.63	V	2	1
Load short-circuiting detection voltage	V <sub>SHORT</sub>	VM voltage based on V <sub>DD</sub>	-1.9	-1.3	-0.7	V	2	1
Charger detection voltage	V <sub>CHA</sub>	—	-2.2	-1.3	-0.4	V	3	1
Overcharge detection voltage temperature factor <sup>*1</sup>	T <sub>COE1</sub>	Ta = -40°C to +85°C	-0.7	0	0.7	mV/°C	—	—
Overcurrent 1 detection voltage temperature factor <sup>*1</sup>	T <sub>COE2</sub>	Ta = -40°C to +85°C	-0.2	0	0.2	mV/°C	—	—
<b>INPUT VOLTAGE, OPERATING VOLTAGE</b>								
Input voltage between VDD and VSS	V <sub>DS1</sub>	absolute maximum rating	-0.3	—	12	V	—	—
Input voltage between VDD and VM	V <sub>DS2</sub>	absolute maximum rating	-0.3	—	26	V	—	—
Operating voltage between VDD and VSS	V <sub>DSOP1</sub>	Internal circuit operating voltage	1.5	—	8	V	—	—
Operating voltage between VDD and VM	V <sub>DSOP2</sub>	Internal circuit operating voltage	1.5	—	24	V	—	—
<b>CURRENT CONSUMPTION Power-down function available</b>								
Current consumption during normal operation	I <sub>OPE</sub>	V <sub>DD</sub> = 3.5 V, V <sub>VM</sub> = 0 V	0.7	3.0	6.0	μA	4	1
Current consumption at power down	I <sub>PDN</sub>	V <sub>DD</sub> = V <sub>VM</sub> = 1.5 V	—	—	0.1	μA	4	1
<b>CURRENT CONSUMPTION Power-down function unavailable</b>								
Current consumption during normal operation	I <sub>OPE</sub>	V <sub>DD</sub> = 3.5 V, V <sub>VM</sub> = 0 V	0.7	3.0	6.0	μA	4	1
Overdischarge current consumption	I <sub>OPEd</sub>	V <sub>DD</sub> = V <sub>VM</sub> = 1.5 V	0.6	2.0	4.5	μA	4	1
<b>OUTPUT RESISTANCE</b>								
CO pin H resistance	R <sub>COH</sub>	V <sub>CO</sub> = 3.0 V, V <sub>DD</sub> = 3.5 V, V <sub>VM</sub> = 0 V	0.07	2	13	kΩ	6	1
CO pin L resistance	R <sub>COL</sub>	V <sub>CO</sub> = 0.5 V, V <sub>DD</sub> = 4.5 V, V <sub>VM</sub> = 0 V	100	600	3500	kΩ	6	1
DO pin H resistance	R <sub>DOH</sub>	V <sub>DO</sub> = 3.0 V, V <sub>DD</sub> = 3.5 V, V <sub>VM</sub> = 0 V	0.07	1.3	7.3	kΩ	7	1
DO pin L resistance	R <sub>DOL</sub>	V <sub>DO</sub> = 0.5 V, V <sub>DD</sub> = V <sub>VM</sub> = 1.8 V	0.07	0.5	2.5	kΩ	7	1
<b>VM INTERNAL RESISTANCE</b>								
Internal resistance between VM and VDD	R <sub>VMD</sub>	V <sub>DD</sub> = 1.8 V, V <sub>VM</sub> = 0 V	78	300	1310	kΩ	5	1
Internal resistance between VM and VSS	R <sub>VMS</sub>	V <sub>DD</sub> = V <sub>VM</sub> = 3.5 V	39	100	220	kΩ	5	1
<b>0 V BATTERY CHARGING FUNCTION</b> The 0 V battery function is either "0 V battery charging function" or "0 V battery charge inhibiting function" depending upon the product type.								
0 V battery charge starting charger voltage	V <sub>0CHA</sub>	0 V battery charging Available	0.0	0.8	1.7	V	10	1
0 V battery charge inhibiting battery voltage	V <sub>0INH</sub>	0 V battery charging Unavailable	0.4	0.9	1.4	V	11	1

\*1. Since products are not screened at high and low temperatures, the specification for this temperature range is guaranteed by design, not tested in production.

**3. Detection delay time**

- (1) S-8241ABA, S-8241ABC, S-8241ABD, S-8241ABE, S-8241ABF, S-8241ABG, S-8241ABH, S-8241ABI, S-8241ABK, S-8241ABL, S-8241ABQ, S-8241ABT, S-8241ABU, S-8241ABV, S-8241ABX, S-8241ABZ, S-8241ACA, S-8241ACB, S-8241ACE, S-8241ACF, S-8241ACG, S-8241ACH, S-8241ACL, S-8241ACO, S-8241ACP, S-8241ACQ, S-8241ACR, S-8241ACS, S-8241ACT, S-8241ACU, S-8241ACX, S-8241ACY, S-8241ADA, S-8241ADD, S-8241ADH, S-8241ADL, S-8241ADM, S-8241ADN, S-8241ADO, S-8241ADQ, S-8241ADR, S-8241ADS, S-8241ADT, S-8241ADV, S-8241ADW, S-8241ADX, S-8241ADY, S-8241ADZ, S-8241AEA, S-8241AEB, S-8241AEC, S-8241AED, S-8241AEF, S-8241AEI, S-8241AEJ, S-8241AEK, S-8241AEM, S-8241AEO, S-8241AEP, S-8241AEQ, S-8241AET, S-8241AEW, S-8241AEX, S-8241AEY, S-8241AFA, S-8241AFB

**Table 10**

Item	Symbol	Condition	Min.	Typ.	Max.	Unit	Test Condition	Test Circuit
<b>DELAY TIME (Ta = 25°C)</b>								
Overcharge detection delay time	t <sub>CU</sub>	—	0.7	1.0	1.3	s	8	1
Overdischarge detection delay time	t <sub>DL</sub>	—	87.5	125	162.5	ms	8	1
Overcurrent 1 detection delay time	t <sub>IOV1</sub>	—	5.6	8	10.4	ms	9	1
Overcurrent 2 detection delay time	t <sub>IOV2</sub>	—	1.4	2	2.6	ms	9	1
Load short-circuiting detection delay time	t <sub>SHORT</sub>	—	—	10	50	μs	9	1
<b>DELAY TIME (Ta = -40°C to +85°C) *1</b>								
Overcharge detection delay time	t <sub>CU</sub>	—	0.55	1.0	1.7	s	8	1
Overdischarge detection delay time	t <sub>DL</sub>	—	69	125	212	ms	8	1
Overcurrent 1 detection delay time	t <sub>IOV1</sub>	—	4.4	8	14	ms	9	1
Overcurrent 2 detection delay time	t <sub>IOV2</sub>	—	1.1	2	3.4	ms	9	1
Load short-circuiting detection delay time	t <sub>SHORT</sub>	—	—	10	73	μs	9	1

\*1. Since products are not screened at high and low temperature, the specification for this temperature range is guaranteed by design, not tested in production.

- (2) S-8241ABB, S-8241ABO, S-8241ABP, S-8241ABS, S-8241ACI, S-8241ACK, S-8241ACN, S-8241ACZ, S-8241ADE, S-8241AEH, S-8241AEN, S-8241AER, S-8241AES, S-8241AEU

**Table 11**

Item	Symbol	Condition	Min.	Typ.	Max.	Unit	Test Condition	Test Circuit
<b>DELAY TIME (Ta = 25°C)</b>								
Overcharge detection delay time	t <sub>CU</sub>	—	87.5	125	162.5	ms	8	1
Overdischarge detection delay time	t <sub>DL</sub>	—	21	31	41	ms	8	1
Overcurrent 1 detection delay time	t <sub>IOV1</sub>	—	11	16	21	ms	9	1
Overcurrent 2 detection delay time	t <sub>IOV2</sub>	—	1.4	2	2.6	ms	9	1
Load short-circuiting detection delay time	t <sub>SHORT</sub>	—	—	10	50	μs	9	1
<b>DELAY TIME (Ta = -40°C to +85°C) *1</b>								
Overcharge detection delay time	t <sub>CU</sub>	—	69	125	212	ms	8	1
Overdischarge detection delay time	t <sub>DL</sub>	—	17	31	53	ms	8	1
Overcurrent 1 detection delay time	t <sub>IOV1</sub>	—	9	16	27	ms	9	1
Overcurrent 2 detection delay time	t <sub>IOV2</sub>	—	1.1	2	3.4	ms	9	1
Load short-circuiting detection delay time	t <sub>SHORT</sub>	—	—	10	73	μs	9	1

\*1. Since products are not screened at high and low temperature, the specification for this temperature range is guaranteed by design, not tested in production.

**(3) S-8241ABW, S-8241ABY****Table 12**

Item	Symbol	Condition	Min.	Typ.	Max.	Unit	Test Condition	Test Circuit
<b>DELAY TIME (Ta = 25°C)</b>								
Overcharge detection delay time	t <sub>CU</sub>	—	0.175	0.25	0.325	s	8	1
Overdischarge detection delay time	t <sub>DL</sub>	—	87.5	125	162.5	ms	8	1
Overcurrent 1 detection delay time	t <sub>IOV1</sub>	—	5.6	8	10.4	ms	9	1
Overcurrent 2 detection delay time	t <sub>IOV2</sub>	—	1.4	2	2.6	ms	9	1
Load short-circuiting detection delay time	t <sub>SHORT</sub>	—	—	10	50	μs	9	1
<b>DELAY TIME (Ta = -40°C to +85°C) *1</b>								
Overcharge detection delay time	t <sub>CU</sub>	—	0.138	0.25	0.425	s	8	1
Overdischarge detection delay time	t <sub>DL</sub>	—	69	125	212	ms	8	1
Overcurrent 1 detection delay time	t <sub>IOV1</sub>	—	4.4	8	14	ms	9	1
Overcurrent 2 detection delay time	t <sub>IOV2</sub>	—	1.1	2	3.4	ms	9	1
Load short-circuiting detection delay time	t <sub>SHORT</sub>	—	—	10	73	μs	9	1

\*1. Since products are not screened at high and low temperature, the specification for this temperature range is guaranteed by design, not tested in production.

**(4) S-8241ABR, S-8241ACD****Table 13**

Item	Symbol	Condition	Min.	Typ.	Max.	Unit	Test Condition	Test Circuit
<b>DELAY TIME (Ta = 25°C)</b>								
Overcharge detection delay time	t <sub>CU</sub>	—	1.4	2.0	2.6	s	8	1
Overdischarge detection delay time	t <sub>DL</sub>	—	87.5	125	162.5	ms	8	1
Overcurrent 1 detection delay time	t <sub>IOV1</sub>	—	5.6	8	10.4	ms	9	1
Overcurrent 2 detection delay time	t <sub>IOV2</sub>	—	1.4	2	2.6	ms	9	1
Load short-circuiting detection delay time	t <sub>SHORT</sub>	—	—	10	50	μs	9	1
<b>DELAY TIME (Ta = -40°C to +85°C) *1</b>								
Overcharge detection delay time	t <sub>CU</sub>	—	1.1	2.0	3.4	s	8	1
Overdischarge detection delay time	t <sub>DL</sub>	—	69	125	212	ms	8	1
Overcurrent 1 detection delay time	t <sub>IOV1</sub>	—	4.4	8	14	ms	9	1
Overcurrent 2 detection delay time	t <sub>IOV2</sub>	—	1.1	2	3.4	ms	9	1
Load short-circuiting detection delay time	t <sub>SHORT</sub>	—	—	10	73	μs	9	1

\*1. Since products are not screened at high and low temperature, the specification for this temperature range is guaranteed by design, not tested in production.

(5) S-8241ADF, S-8241ADG, S-8241ADI, S-8241ADJ, S-8241ADK, S-8241AEV

**Table 14**

Item	Symbol	Condition	Min.	Typ.	Max.	Unit	Test Condition	Test Circuit
<b>DELAY TIME (Ta = 25°C)</b>								
Overcharge detection delay time	t <sub>CU</sub>	—	0.175	0.25	0.325	ms	8	1
Overdischarge detection delay time	t <sub>DL</sub>	—	21	31	41	ms	8	1
Overcurrent 1 detection delay time	t <sub>IOV1</sub>	—	11	16	21	ms	9	1
Overcurrent 2 detection delay time	t <sub>IOV2</sub>	—	1.4	2	2.6	ms	9	1
Load short-circuiting detection delay time	t <sub>SHORT</sub>	—	—	10	50	μs	9	1
<b>DELAY TIME (Ta = -40°C to +85°C) *1</b>								
Overcharge detection delay time	t <sub>CU</sub>	—	0.138	0.25	0.425	s	8	1
Overdischarge detection delay time	t <sub>DL</sub>	—	17	31	53	ms	8	1
Overcurrent 1 detection delay time	t <sub>IOV1</sub>	—	9	16	27	ms	9	1
Overcurrent 2 detection delay time	t <sub>IOV2</sub>	—	1.1	2	3.4	ms	9	1
Load short-circuiting detection delay time	t <sub>SHORT</sub>	—	—	10	73	μs	9	1

\*1. Since products are not screened at high and low temperature, the specification for this temperature range is guaranteed by design, not tested in production.

(6) S-8241AEE

**Table 15**

Item	Symbol	Condition	Min.	Typ.	Max.	Unit	Test Condition	Test Circuit
<b>DELAY TIME (Ta = 25°C)</b>								
Overcharge detection delay time	t <sub>CU</sub>	—	0.7	1.0	1.3	s	8	1
Overdischarge detection delay time	t <sub>DL</sub>	—	87.5	125	162.5	ms	8	1
Overcurrent 1 detection delay time	t <sub>IOV1</sub>	—	11	16	21	ms	9	1
Overcurrent 2 detection delay time	t <sub>IOV2</sub>	—	1.4	2	2.6	ms	9	1
Load short-circuiting detection delay time	t <sub>SHORT</sub>	—	—	10	50	μs	9	1
<b>DELAY TIME (Ta = -40°C to +85°C) *1</b>								
Overcharge detection delay time	t <sub>CU</sub>	—	0.55	1.0	1.7	s	8	1
Overdischarge detection delay time	t <sub>DL</sub>	—	69	125	212	ms	8	1
Overcurrent 1 detection delay time	t <sub>IOV1</sub>	—	9	16	27	ms	9	1
Overcurrent 2 detection delay time	t <sub>IOV2</sub>	—	1.1	2	3.4	ms	9	1
Load short-circuiting detection delay time	t <sub>SHORT</sub>	—	—	10	73	μs	9	1

\*1. Since products are not screened at high and low temperature, the specification for this temperature range is guaranteed by design, not tested in production.

## (7) S-8241AEG

Table 16

Item	Symbol	Condition	Min.	Typ.	Max.	Unit	Test Condition	Test Circuit
<b>DELAY TIME (Ta = 25°C)</b>								
Overcharge detection delay time	t <sub>CU</sub>	—	0.35	0.5	0.65	s	8	1
Overdischarge detection delay time	t <sub>DL</sub>	—	87.5	125	162.5	ms	8	1
Overcurrent 1 detection delay time	t <sub>IOV1</sub>	—	5.6	8	10.4	ms	9	1
Overcurrent 2 detection delay time	t <sub>IOV2</sub>	—	1.4	2	2.6	ms	9	1
Load short-circuiting detection delay time	t <sub>SHORT</sub>	—	—	10	50	μs	9	1
<b>DELAY TIME (Ta = -40°C to +85°C) *1</b>								
Overcharge detection delay time	t <sub>CU</sub>	—	0.275	0.5	0.85	s	8	1
Overdischarge detection delay time	t <sub>DL</sub>	—	69	125	212	ms	8	1
Overcurrent 1 detection delay time	t <sub>IOV1</sub>	—	4.4	8	14	ms	9	1
Overcurrent 2 detection delay time	t <sub>IOV2</sub>	—	1.1	2	3.4	ms	9	1
Load short-circuiting detection delay time	t <sub>SHORT</sub>	—	—	10	73	μs	9	1

\*1. Since products are not screened at high and low temperature, the specification for this temperature range is guaranteed by design, not tested in production.



## ■ Test Circuits

**Caution** Unless otherwise specified, the output voltage levels “H” and “L” at CO pin ( $V_{CO}$ ) and DO pin ( $V_{DO}$ ) are judged by the threshold voltage (1.0 V) of the N-channel FET. Judge the CO pin level with respect to  $V_{VM}$  and the DO pin level with respect to  $V_{SS}$ .

### (1) Test Condition 1, Test Circuit 1

**(Overcharge detection voltage, Overcharge release voltage, Overdischarge detection voltage, Overdischarge release voltage)**

The overcharge detection voltage ( $V_{CU}$ ) is defined by the voltage between VDD and VSS at which  $V_{CO}$  goes “L” from “H” when the voltage V1 is gradually increased from the normal condition  $V1 = 3.5\text{ V}$  and  $V2 = 0\text{ V}$ . The overcharge release voltage ( $V_{CL}$ ) is defined by the voltage between VDD and VSS at which  $V_{CO}$  goes “H” from “L” when the voltage V1 is then gradually decreased.

Gradually decreasing the voltage V1, the overdischarge detection voltage ( $V_{DL}$ ) is defined by the voltage between VDD and VSS at which  $V_{DO}$  goes “L” from “H”. The overdischarge release voltage ( $V_{DU}$ ) is defined by the voltage between VDD and VSS at which  $V_{DO}$  goes “H” from “L” when the voltage V1 is then gradually increased.

### (2) Test Condition 2, Test Circuit 1

**(Overcurrent 1 detection voltage, Overcurrent 2 detection voltage, Load short-circuiting detection voltage)**

The overcurrent 1 detection voltage ( $V_{IOV1}$ ) is defined by the voltage between VDD and VSS at which  $V_{DO}$  goes “L” from “H” when the voltage V2 is gradually increased from the normal condition  $V1 = 3.5\text{ V}$  and  $V2 = 0\text{ V}$ .

The overcurrent 2 detection voltage ( $V_{IOV2}$ ) is defined by the voltage between VDD and VSS at which  $V_{DO}$  goes “L” from “H” when the voltage V2 is increased at the speed between 1 ms and 4 ms from the normal condition  $V1 = 3.5\text{ V}$  and  $V2 = 0\text{ V}$ .

The load short-circuiting detection voltage ( $V_{SHORT}$ ) is defined by the voltage between VDD and VSS at which  $V_{DO}$  goes “L” from “H” when the voltage V2 is increased at the speed between 1  $\mu\text{s}$  and 50  $\mu\text{s}$  from the normal condition  $V1 = 3.5\text{ V}$  and  $V2 = 0\text{ V}$ .

### (3) Test Condition 3, Test Circuit 1

**(Charger detection voltage, (= abnormal charge current detection voltage) )**

- Applied only for products with overdischarge hysteresis  
Set  $V1 = 1.8\text{ V}$  and  $V2 = 0\text{ V}$  under overdischarge condition. Increase V1 gradually, set  $V1 = (V_{DU} + V_{DL}) / 2$  (within overdischarge hysteresis, overdischarge condition), then decrease V2 from 0 V gradually. The voltage between VM and VSS at which  $V_{DO}$  goes “H” from “L” is the charger detection voltage ( $V_{CHA}$ ).
- Applied only for products without overdischarge hysteresis  
Set  $V1 = 3.5\text{ V}$  and  $V2 = 0\text{ V}$  under normal condition. Decrease V2 from 0 V gradually. The voltage between VM and VSS at which  $V_{CO}$  goes “L” from “H” is the abnormal charge current detection voltage. The abnormal charge current detection voltage has the same value as the charger detection voltage ( $V_{CHA}$ ).

### (4) Test Condition 4, Test Circuit 1

**(Normal operation current consumption, Power-down current consumption, Overdischarge current consumption)**

Set  $V1 = 3.5\text{ V}$  and  $V2 = 0\text{ V}$  under normal condition. The current  $I_{DD}$  flowing through VDD pin is the normal operation consumption current ( $I_{OPE}$ ).

- For products with power-down function  
Set  $V1 = V2 = 1.5\text{ V}$  under overdischarge condition. The current  $I_{DD}$  flowing through VDD pin is the power-down current consumption ( $I_{PDN}$ ).
- For products without power-down function  
Set  $V1 = V2 = 1.5\text{ V}$  under overdischarge condition. The current  $I_{DD}$  flowing through VDD pin is the overdischarge current consumption ( $I_{OPED}$ ).



**(5) Test Condition 5, Test Circuit 1**

**(Internal resistance between VM and VDD, Internal resistance between VM and VSS)**

Set  $V_1 = 1.8\text{ V}$  and  $V_2 = 0\text{ V}$  under overdischarge condition. Measure current  $I_{VM}$  flowing through VM pin.  $1.8\text{ V} / |I_{VM}|$  gives the internal resistance ( $R_{VMD}$ ) between VM and VDD.

Set  $V_1 = V_2 = 3.5\text{ V}$  under overcurrent condition. Measure current  $I_{VM}$  flowing through VM pin.  $3.5\text{ V} / |I_{VM}|$  gives the internal resistance ( $R_{VMS}$ ) between VM and VSS.

**(6) Test Condition 6, Test Circuit 1**

**(CO pin H resistance, CO pin L resistance)**

Set  $V_1 = 3.5\text{ V}$ ,  $V_2 = 0\text{ V}$  and  $V_3 = 3.0\text{ V}$  under normal condition. Measure current  $I_{CO}$  flowing through CO pin.  $0.5\text{ V} / |I_{CO}|$  is the CO pin H resistance ( $R_{COH}$ ).

Set  $V_1 = 4.5\text{ V}$ ,  $V_2 = 0\text{ V}$  and  $V_3 = 0.5\text{ V}$  under overcharge condition. Measure current  $I_{CO}$  flowing through CO pin.  $0.5\text{ V} / |I_{CO}|$  is the CO pin L resistance ( $R_{COL}$ ).

**(7) Test Condition 7, Test Circuit 1**

**(DO pin H resistance, DO pin L resistance)**

Set  $V_1 = 3.5\text{ V}$ ,  $V_2 = 0\text{ V}$  and  $V_4 = 3.0\text{ V}$  under normal condition. Measure current  $I_{DO}$  flowing through DO pin.  $0.5\text{ V} / |I_{DO}|$  gives the DO pin H resistance ( $R_{DOH}$ ).

Set  $V_1 = 1.8\text{ V}$ ,  $V_2 = 0\text{ V}$  and  $V_4 = 0.5\text{ V}$  under overdischarge condition. Measure current  $I_{DO}$  flowing through DO pin.  $0.5\text{ V} / |I_{DO}|$  gives the DO pin L resistance ( $R_{DOL}$ ).

**(8) Test Condition 8, Test Circuit 1**

**(Overcharge detection delay time, Overdischarge detection delay time)**

Set  $V_1 = 3.5\text{ V}$  and  $V_2 = 0\text{ V}$  under normal condition. Increase  $V_1$  gradually to overcharge detection voltage  $V_{CU} - 0.2\text{ V}$  and increase  $V_1$  to the overcharge detection voltage  $V_{CU} + 0.2\text{ V}$  momentarily (within  $10\text{ }\mu\text{s}$ ). The time after  $V_1$  becomes the overcharge detection voltage until  $V_{CO}$  goes "L" is the overcharge detection delay time ( $t_{CU}$ ).

Set  $V_1 = 3.5\text{ V}$  and  $V_2 = 0\text{ V}$  under normal condition. Decrease  $V_1$  gradually to overdischarge detection voltage  $V_{DL} + 0.2\text{ V}$  and decrease  $V_1$  to the overdischarge detection voltage  $V_{DL} - 0.2\text{ V}$  momentarily (within  $10\text{ }\mu\text{s}$ ). The time after  $V_1$  becomes the overdischarge detection voltage  $V_{DL}$  until  $V_{DO}$  goes "L" is the overdischarge detection delay time ( $t_{DL}$ ).

**(9) Test Condition 9, Test Circuit 1**

**(Overcurrent 1 detection delay time, Overcurrent 2 detection delay time, Load short-circuiting detection delay time, Abnormal charge current detection delay time)**

Set  $V_1 = 3.5\text{ V}$  and  $V_2 = 0\text{ V}$  under normal condition. Increase  $V_2$  from  $0\text{ V}$  to  $0.35\text{ V}$  momentarily (within  $10\text{ }\mu\text{s}$ ). The time after  $V_2$  becomes overcurrent 1 detection voltage ( $V_{IOV1}$ ) until  $V_{DO}$  goes "L" is overcurrent 1 detection delay time ( $t_{IOV1}$ ).

Set  $V_1 = 3.5\text{ V}$  and  $V_2 = 0\text{ V}$  under normal condition. Increase  $V_2$  from  $0\text{ V}$  to  $0.7\text{ V}$  momentarily (within  $1\text{ }\mu\text{s}$ ). The time after  $V_2$  becomes overcurrent 2 detection voltage ( $V_{IOV2}$ ) until  $V_{DO}$  goes "L" is overcurrent 2 detection delay time ( $t_{IOV2}$ ).

**Caution** The overcurrent 2 detection delay time starts when the overcurrent 1 is detected, since the delay circuit is common.

Set  $V_1 = 3.5\text{ V}$  and  $V_2 = 0\text{ V}$  under normal condition. Increase  $V_2$  from  $0\text{ V}$  to  $3.0\text{ V}$  momentarily (within  $1\text{ }\mu\text{s}$ ). The time after  $V_2$  becomes the load short-circuiting detection voltage ( $V_{SHORT}$ ) until  $V_{DO}$  goes "L" is the load short-circuiting detection delay time ( $t_{SHORT}$ ).

Set  $V_1 = 3.5\text{ V}$  and  $V_2 = 0\text{ V}$  under normal condition. Decrease  $V_2$  from  $0\text{ V}$  to  $-2.5\text{ V}$  momentarily (within  $10\text{ }\mu\text{s}$ ). The time after  $V_2$  becomes the charger detection voltage ( $V_{CHA}$ ) until  $V_{CO}$  goes "L" is the abnormal charge current detection delay time. The abnormal charge current detection delay time has the same value as the overcharge detection delay time.

**(10) Test Condition 10, Test Circuit 1 (Product with 0 V battery charging function)**  
**(0 V battery charge start charger voltage)**

Set  $V_1 = V_2 = 0\text{ V}$  and decrease  $V_2$  gradually. The voltage between  $V_{DD}$  and  $V_M$  at which  $V_{CO}$  goes "H" ( $V_{VM} + 0.1\text{ V}$  or higher) is the 0 V battery charge starting charger voltage ( $V_{0CHA}$ ).

**(11) Test Condition 11, Test Circuit 1 (Product with 0 V battery charge inhibiting function)**  
**(0 V battery charge inhibiting battery voltage)**

Set  $V_1 = 0\text{ V}$  and  $V_2 = -4\text{ V}$ . Increase  $V_1$  gradually. The voltage between  $V_{DD}$  and  $V_{SS}$  at which  $V_{CO}$  goes "H" ( $V_{VM} + 0.1\text{ V}$  or higher) is the 0 V battery charge inhibiting battery voltage ( $V_{0INH}$ ).



Figure 5

NOT RECOMMENDED FOR NEW DESIGN

## ■ Operation

**Remark** Refer to the “■ Battery Protection IC Connection Example”.

### 1. Normal Status

The S-8241 monitors the voltage of the battery connected to VDD and VSS pins and the voltage difference between VM and VSS pins to control charging and discharging. When the battery voltage is in the range from the overdischarge detection voltage ( $V_{DL}$ ) to the overcharge detection voltage ( $V_{CU}$ ), and the VM pin voltage is in the range from the charger detection voltage ( $V_{CHA}$ ) to the overcurrent 1 detection voltage ( $V_{IOV1}$ ) (the current flowing through the battery is equal to or lower than a specified value), the IC turns both the charging and discharging control FETs on. This status is called normal status and in this status charging and discharging can be carried out freely.

### 2. Overcurrent Status

When the discharging current becomes equal to or higher than a specified value (the VM pin voltage is equal to or higher than the overcurrent detection voltage) during discharging under normal status and the state continues for the overcurrent detection delay time or longer, the S-8241 turns the discharging control FET off to stop discharging. This status is called overcurrent status. (The overcurrent includes overcurrent 1, overcurrent 2, or load short-circuiting.)

The VM and VSS pins are shorted internally by the  $R_{VMS}$  resistor under the overcurrent status. When a load is connected, the VM pin voltage equals the  $V_{DD}$  voltage due to the load.

The overcurrent status returns to the normal status when the load is released and the impedance between the EB+ and EB- pins (see the **Figure 12** for a connection example) becomes higher than the automatic recoverable impedance (see the equation [1] below). When the load is removed, the VM pin goes back to the  $V_{SS}$  potential since the VM pin is shorted the VSS pin with the  $R_{VMS}$  resistor. Detecting that the VM pin potential is lower than the overcurrent 1 detection voltage ( $V_{IOV1}$ ), the IC returns to the normal status.

Automatic recoverable impedance = {Battery voltage / (Minimum value of overcurrent 1 detection voltage) – 1} x ( $R_{VMS}$  maximum value) --- [1]

Example: Battery voltage = 3.5 V and overcurrent 1 detection voltage ( $V_{IOV1}$ ) = 0.1 V  
Automatic recoverable impedance = (3.5 V / 0.07 V – 1) x 200 k $\Omega$  = 9.8 M $\Omega$

**Remark** The automatic recoverable impedance varies with the battery voltage and overcurrent 1 detection voltage settings. Determine the minimum value of the open load using the above equation [1] to have automatic recovery from the overcurrent status work after checking the overcurrent 1 detection voltage setting for the IC.

NOT RECOMMENDED FOR NEW DESIGN

### 3. Overcharge Status

When the battery voltage becomes higher than the overcharge detection voltage ( $V_{CU}$ ) during charging under normal status and the state continues for the overcharge detection delay time ( $t_{CU}$ ) or longer, the S-8241 turns the charging control FET off to stop charging. This status is called the overcharge status.

The overcharge status is released in the following two cases ((1) and (2)) depending on the products with and without overcharge hysteresis:

#### **Products with overcharge hysteresis (overcharge detection voltage ( $V_{CU}$ ) > overcharge release voltage ( $V_{CL}$ ))**

- (1) When the battery voltage drops below the overcharge release voltage ( $V_{CL}$ ), the S-8241 turns the charging control FET on and returns to the normal status.
- (2) When a load is connected and discharging starts, the S-8241 turns the charging control FET on and returns to the normal status. The release mechanism is as follows: the discharging current flows through an internal parasitic diode of the charging FET immediately after a load is connected and discharging starts, and the VM pin voltage increases about 0.7 V ( $V_f$  voltage of the diode) from the VSS pin voltage momentarily. The IC detects this voltage (being higher than the overcurrent 1 detection voltage) and releases the overcharge status. Consequently, in the case that the battery voltage is equal to or lower than the overcharge detection voltage ( $V_{CU}$ ), the IC returns to the normal status immediately, but in the case the battery voltage is higher than the overcharge detection voltage ( $V_{CU}$ ), the IC does not return to the normal status until the battery voltage drops below the overcharge detection voltage ( $V_{CU}$ ) even if the load is connected. In addition if the VM pin voltage is equal to or lower than the overcurrent 1 detection voltage when a load is connected and discharging starts, the IC does not return to the normal status.

**Remark** If the battery is charged to a voltage higher than the overcharge detection voltage ( $V_{CU}$ ) and the battery voltage does not drop below the overcharge detection voltage ( $V_{CU}$ ) even when a heavy load, which causes an overcurrent, is connected, the overcurrent 1 and overcurrent 2 do not work until the battery voltage drops below the overcharge detection voltage ( $V_{CU}$ ). Since an actual battery has, however, an internal impedance of several dozens of  $m\Omega$ , and the battery voltage drops immediately after a heavy load which causes an overcurrent is connected, the overcurrent 1 and overcurrent 2 work. Detection of load short-circuiting works regardless of the battery voltage.

#### **Products without overcharge hysteresis (Overcharge detection voltage ( $V_{CU}$ ) = Overcharge release voltage ( $V_{CL}$ ))**

- (1) When the battery voltage drops below the overcharge release voltage ( $V_{CL}$ ), the S-8241 turns the charging control FET on and returns to the normal status.
- (2) When a load is connected and discharging starts, the S-8241 turns the charging control FET on and returns to the normal status. The release mechanism is explained as follows: the discharging current flows through an internal parasitic diode of the charging FET immediately after a load is connected and discharging starts, and the VM pin voltage increases about 0.7 V ( $V_f$  voltage of the diode) from the VSS pin voltage momentarily. Detecting this voltage (being higher than the overcurrent 1 detection voltage), the IC increases the overcharge detection voltage about 50 mV, and releases the overcharge status. Consequently, when the battery voltage is equal to or lower than the overcharge detection voltage ( $V_{CU}$ ) + 50 mV, the S-8241 immediately returns to the normal status. But the battery voltage is higher than the overcharge detection voltage ( $V_{CU}$ ) + 50 mV, the S-8241 does not return to the normal status until the battery voltage drops below the overcharge detection voltage ( $V_{CU}$ ) + 50 mV even if a load is connected. If the VM pin voltage is equal to or lower than the overcurrent 1 detection voltage when a load is connected and discharging starts, the S-8241 does not return to the normal status.

**Remark** If the battery is charged to a voltage higher than the overcharge detection voltage ( $V_{CU}$ ) and the battery voltage does not drop below the overcharge detection voltage ( $V_{CU}$ ) + 50 mV even when a heavy load, which causes an overcurrent, is connected, the overcurrent 1 and overcurrent 2 do not work until the battery voltage drops below the overcharge detection voltage ( $V_{CU}$ ) + 50 mV. Since an actual battery has, however, an internal impedance of several dozens of  $m\Omega$ , and the battery voltage drops immediately after a heavy load which causes an overcurrent is connected, the overcurrent 1 and overcurrent 2 work. Detection of load short-circuiting works regardless of the battery voltage.

#### 4. Overdischarge Status

##### With power-down function

When the battery voltage drops below the overdischarge detection voltage ( $V_{DL}$ ) during discharging under normal status and it continues for the overdischarge detection delay time ( $t_{DL}$ ) or longer, the S-8241 turns the discharging control FET off and stops discharging. This status is called overdischarge status. After the discharging control FET is turned off, the VM pin is pulled up by the  $R_{VMD}$  resistor between VM and VDD in the IC. Meanwhile the potential difference between VM and VDD drops below 1.3 V (typ.) (the load short-circuiting detection voltage), current consumption of the IC is reduced to the power-down current consumption ( $I_{PDN}$ ). This status is called power-down status. The VM and VDD pins are shorted by the  $R_{VMD}$  resistor in the IC under the overdischarge and power-down statuses.

The power-down status is released when a charger is connected and the potential difference between VM and VDD becomes 1.3 V (typ.) or higher (load short-circuiting detection voltage). At this time, the FET is still off. When the battery voltage becomes the overdischarge detection voltage ( $V_{DL}$ ) or higher<sup>\*1</sup>, the S-8241 turns the FET on and changes to the normal status from the overdischarge status.

- \*1. If the VM pin voltage is no less than the charger detection voltage ( $V_{CHA}$ ), when the battery under overdischarge status is connected to a charger, the overdischarge status is released (the discharging control FET is turned on) as usual, provided that the battery voltage reaches the overdischarge release voltage ( $V_{DU}$ ) or higher.

##### Without power-down function

When the battery voltage drops below the overdischarge detection voltage ( $V_{DL}$ ) during discharging under normal status and it continues for the overdischarge detection delay time ( $t_{DL}$ ) or longer, the S-8241 turns the discharging control FET off and stops discharging. When the discharging control FET is turned off, the VM pin is pulled up by the  $R_{VMD}$  resistor between VM and VDD in the IC. Meanwhile the potential difference between VM and VDD drops below 1.3 V (typ.) (the load short-circuiting detection voltage), current consumption of the IC is reduced to the overdischarge current consumption ( $I_{OPED}$ ). This status is called overdischarge status. The VM and VDD pins are shorted by the  $R_{VMD}$  resistor in the IC under the overdischarge status.

When a charger is connected, the overdischarge status is released in the same way as explained above in respect to products having the power-down function. For products without the power-down function, in addition, even if the charger is not connected, the S-8241 turns the discharging control FET on and changes to the normal status from the overdischarge status provided that the load is disconnected and that the potential difference between VM and VSS drops below the overcurrent 1 detection voltage ( $V_{IOV1}$ ), since the VM pin is pulled down by the  $R_{VMS}$  resistor between VM and VSS in the IC when the battery voltage reaches the overdischarge release voltage ( $V_{DU}$ ) or higher.

#### 5. Charger Detection

If the VM pin voltage is lower than the charger detection voltage ( $V_{CHA}$ ) when a battery in overdischarge status is connected to a charger, overdischarge hysteresis is released, and when the battery voltage becomes equal to or higher than the overdischarge detection voltage ( $V_{DL}$ ), the overdischarge status is released (the discharging control FET is turned on). This action is called charger detection. (The charger detection reduces the time for charging in which charging current flows through the internal parasitic diode in the discharging control FET).

If the VM pin voltage is not lower than the charger detection voltage ( $V_{CHA}$ ) when a battery in overdischarge status is connected to a charger, the overdischarge status is released (the discharging control FET is turned on) as usual, when the battery voltage reaches the overdischarge release voltage ( $V_{DU}$ ) or higher.

**6. Abnormal Charge Current Detection**

If the VM pin voltage drops below the charger detection voltage ( $V_{CHA}$ ) during charging under the normal status and it continues for the overcharge detection delay time ( $t_{CU}$ ) or longer, the S-8241 turns the charging control FET off and stops charging. This action is called abnormal charge current detection.

Abnormal charge current detection works when the discharging control FET is on (DO pin voltage is "H") and the VM pin voltage drops below the charger detection voltage ( $V_{CHA}$ ). When an abnormal charge current flows into a battery in the overdischarge status, the S-8241 consequently turns the charging control FET off and stops charging after the battery voltage becomes the overdischarge detection voltage or higher (DO pin voltage becomes "H") and the overcharge detection delay time ( $t_{CU}$ ) elapses.

Abnormal charge current detection is released when the voltage difference between VM pin and VSS pin becomes lower than the charger detection voltage ( $V_{CHA}$ ) by separating the charger.

Since the 0 V battery charging function has higher priority than the abnormal charge current detection function, abnormal charge current may not be detected by the product with the 0 V battery charging function while the battery voltage is low.

**7. Delay Circuits**

The detection delay times are determined by dividing a clock of approximately 2 kHz by the counter.

[Example] Overcharge detection delay time (= abnormal charge current detection delay time): 1.0 s

Overdischarge detection delay time: 125 ms

Overcurrent 1 detection delay time: 8 ms

Overcurrent 2 detection delay time: 2 ms

**Caution 1. Counting for the overcurrent 2 detection delay time starts when the overcurrent 1 is detected. Having detected the overcurrent 1, if the overcurrent 2 is detected after the overcurrent 2 detection delay time, the S-8241 Series turns the discharging control FET off as shown in the Figure 6. In this case, the overcurrent 2 detection delay time may seem to be longer or overcurrent 1 detection delay time may seem to be shorter than expected.**



**Figure 6**



### 2. <For products with power-down function>

After having detected an overcurrent (overcurrent 1, overcurrent 2, short-circuiting), the state is held for the overdischarge detection delay time or longer without releasing the load, the status changes to the power-down status when the battery voltage drops below the overdischarge detection voltage. If the battery voltage drops below the overdischarge detection voltage due to overcurrent, the discharging control FET is turned off when the overcurrent is detected. If the battery voltage recovers slowly and if the battery voltage after the overdischarge detection delay time is equal to or lower than the overdischarge detection voltage, the S-8241 changes to the power-down status.

### <For products without power-down function>

After having detected an overcurrent (overcurrent 1, overcurrent 2, short-circuiting), the state is held for the overdischarge detection delay time or longer without releasing the load, the status changes to the overdischarge status when the battery voltage drops below the overdischarge detection voltage. If the battery voltage drops below the overdischarge detection voltage due to overcurrent, the discharging control FET is turned off when the overcurrent is detected. If the battery voltage recovers slowly and if the battery voltage after the overdischarge detection delay time is equal to or lower than the overdischarge detection voltage, the S-8241 changes to the overdischarge status.

## 8. 0 V Battery Charging Function

This function enables the charging of a connected battery whose voltage is 0 V by self-discharge. When a charger having 0 V battery start charging charger voltage ( $V_{0CHA}$ ) or higher is connected between EB+ and EB- pins, the charging control FET gate is fixed to  $V_{DD}$  potential. When the voltage between the gate and the source of the charging control FET becomes equal to or higher than the turn-on voltage by the charger voltage, the charging control FET is turned on to start charging. At this time, the discharging control FET is off and the charging current flows through the internal parasitic diode in the discharging control FET. If the battery voltage becomes equal to or higher than the overdischarge release voltage ( $V_{DU}$ ), the normal status returns.

- Caution**
1. Some battery providers do not recommend charging of completely discharged batteries. Please refer to battery providers before the selection of 0 V battery charging function.
  2. The 0 V battery charging function has higher priority than the abnormal charge current detection function. Consequently, a product with the 0 V battery charging function charges a battery and abnormal charge current cannot be detected during the battery voltage is low (at most 1.8 V or lower).
  3. When a battery is connected to the IC for the first time, the IC may not enter the normal status in which discharging is possible. In this case, set the VM pin voltage equal to the  $V_{SS}$  voltage (short the VM and VSS pins or connect a charger) to enter the normal status.

## 9. 0 V Battery Charge Inhibiting Function

This function forbids the charging of a connected battery which is short-circuited internally (0 V battery). When the battery voltage becomes 0.9 V (typ.) or lower, the charging control FET gate is fixed to EB- potential to forbid charging. Charging can be performed, when the battery voltage is the 0 V battery charge inhibiting voltage ( $V_{0INH}$ ) or higher.

- Caution**
1. Some battery providers do not recommend charging of completely discharged batteries. Please refer to battery providers before the selection of 0 V battery charging function.
  2. When a battery is connected to the IC for the first time, the IC may not enter the normal status in which discharging is possible. In this case, set the VM pin voltage equal to the  $V_{SS}$  voltage (short the VM and VSS pins or connect a charger) to enter the normal status.

■ **Timing Chart**

(1) **Overcharge and overdischarge detection (for products with power-down function)**

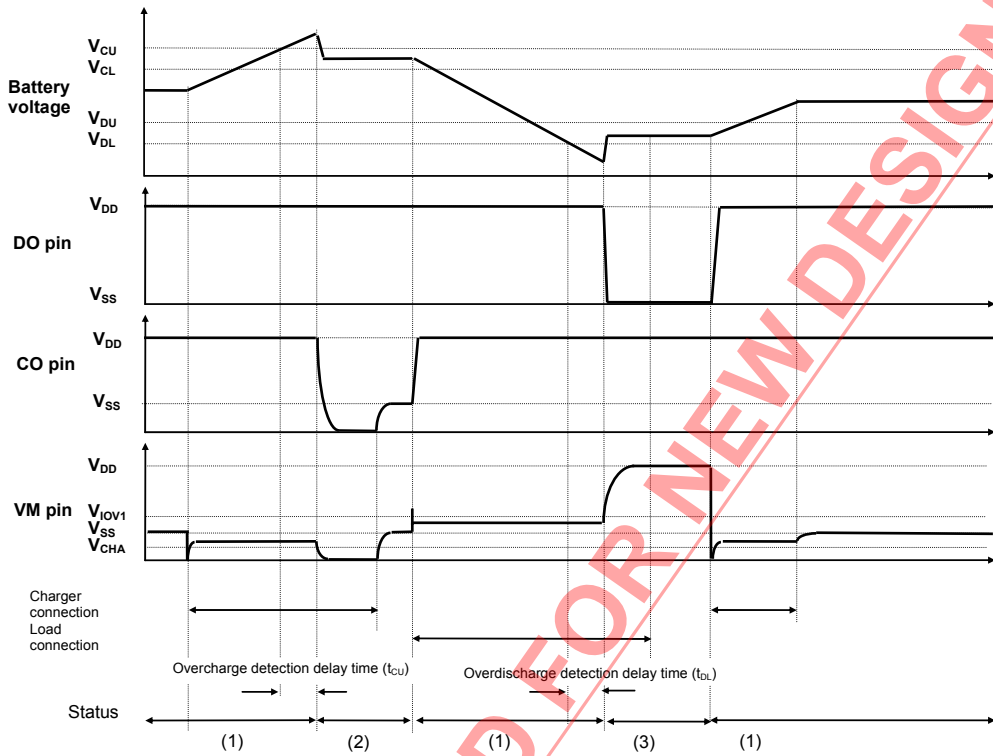

Remark (1) : Normal status, (2) : Overcharge status, (3) : Overdischarge status, (4) : Overcurrent status  
 The charger is assumed to charge with a constant current.

**Figure 7**

(2) **Overcharge and overdischarge detection (for products without power-down function)**

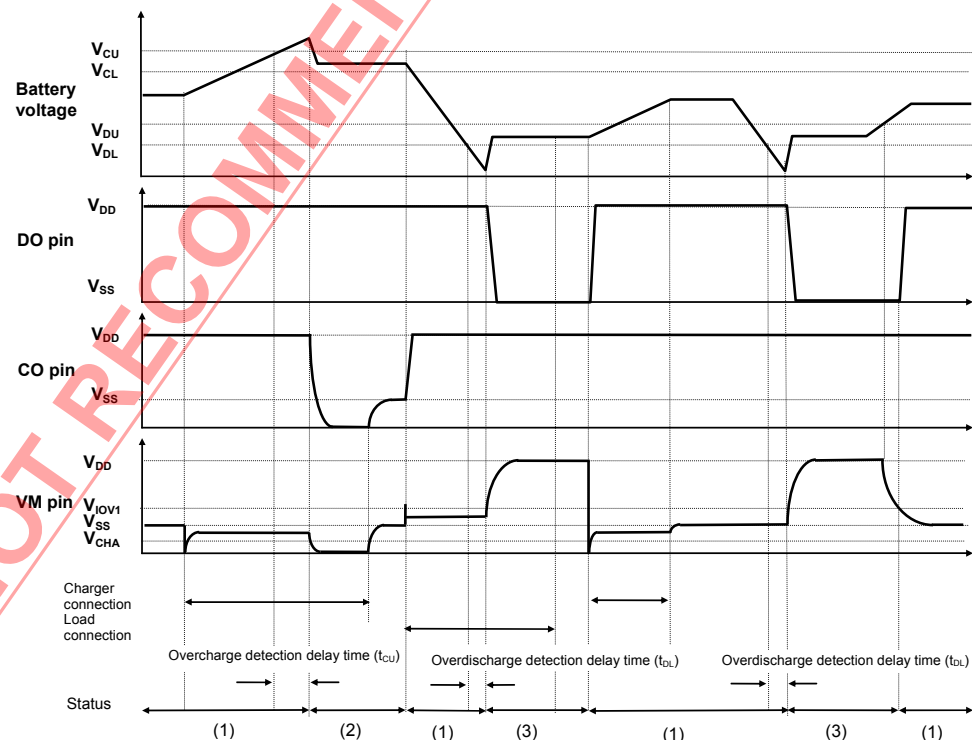

Remark (1) : Normal status, (2) : Overcharge status, (3) : Overdischarge status, (4) : Overcurrent status  
 The charger is assumed to charge with a constant current.

**Figure 8**



(3) Overcurrent detection



**Remark** (1) : Normal status, (2) : Overcharge status, (3) : Overdischarge status, (4) : Overcurrent status  
The charger is assumed to charge with constant current.

Figure 9

(4) Charger detection



**Remark** (1) : Normal status, (2) : Overcharge status, (3) : Overdischarge status, (4) : Overcurrent status  
The charger is assumed to charge with constant current.

Figure 10

(5) Abnormal charge current detection



**Remark** (1) : Normal status, (2) : Overcharge status, (3) : Overdischarge status, (4) : Overcurrent status  
The charger is assumed to charge with constant current.

Figure 11

NOT RECOMMENDED FOR NEW DESIGN

■ **Battery Protection IC Connection Example**



Figure 12

Table 17 Constants for External Components

Symbol	Parts	Purpose	Min.	Typ.	Max.	Remarks
FET1	Nch MOS_FET	Discharge control	—	—	—	0.4 V ≤ Threshold voltage ≤ overdischarge detection voltage. <sup>*1</sup> Withstand voltage between gate and source ≥ Charger voltage <sup>*2</sup>
FET2	Nch MOS_FET	Charge control	—	—	—	0.4 V ≤ Threshold voltage ≤ overdischarge detection voltage. <sup>*1</sup> Withstand voltage between gate and source ≥ Charger voltage <sup>*2</sup>
R1	Resistor	Protection for ESD and power fluctuation	300 Ω	470 Ω	R2 value	Relation R1 ≤ R2 should be maintained. <sup>*3</sup>
C1	Capacitor	Protection for power fluctuation	0.01 μF	0.1 μF	1.0 μF	Install a capacitor of 0.01 μF or higher between VDD and VSS. <sup>*4</sup>
R2	Resistor	Protection for charger reverse connection	300 Ω	1 kΩ	1.3 kΩ	To suppress current flow caused by reverse connection of a charger, set the resistance within the range from 300 Ω to 1.3 kΩ. <sup>*5</sup>

- \*1. If an FET with a threshold voltage of 0.4 V or lower is used, the FET may fail to cut the charging current.  
If an FET with a threshold voltage equal to or higher than the overdischarge detection voltage is used, discharging may stop before overdischarge is detected.
- \*2. If the withstand voltage between the gate and source is lower than the charger voltage, the FET may break.
- \*3. If R1 has a higher resistance than R2 and if a charger is connected reversely, current flows from the charger to the IC and the voltage between VDD and VSS may exceed the absolute maximum rating. Install a resistor of 300 Ω or higher as R1 for ESD protection.  
If R1 has a high resistance, the overcharge detection voltage increases by IC current consumption.
- \*4. If a capacitor C1 is less than 0.01 μF, DO may oscillate when load short-circuiting is detected, a charger is connected reversely, or overcurrent 1 or 2 is detected.  
A capacitor of 0.01 μF or higher as C1 should be installed. In some types of batteries DO oscillation may not stop unless the C1 capacity is increased. Set the C1 capacity by evaluating the actual application.
- \*5. If R2 is set to less than 300 Ω, a current which is bigger than the power dissipation flows through the IC and the IC may break when a charger is connected reversely. If a resistor bigger than 1.3 kΩ is installed as R2, the charging current may not be cut when a high-voltage charger is connected.

**Caution**

1. The above constants may be changed without notice.
2. It has not been confirmed whether the operation is normal or not in circuits other than the above example of connection. In addition, the example of connection shown above and the constant do not guarantee proper operation. Perform thorough evaluation using the actual application to set the constant.

■ **Precautions**

- Pay attention to the operating conditions for input/output voltage and load current so that the power loss in the IC does not exceed the power dissipation of the package.
- Do not apply an electrostatic discharge to this IC that exceeds the performance ratings of the built-in electrostatic protection circuit.
- SII claims no responsibility for any and all disputes arising out of or in connection with any infringement by products including this IC of patents owned by a third party.

**NOT RECOMMENDED FOR NEW DESIGN**

■ Characteristics (Typical Data)

1. Detection/release voltage temperature characteristics



2. Current consumption temperature characteristics



**3. Current consumption Power voltage characteristics (Ta = 25°C)**



**4. Detection/release delay time temperature characteristics**

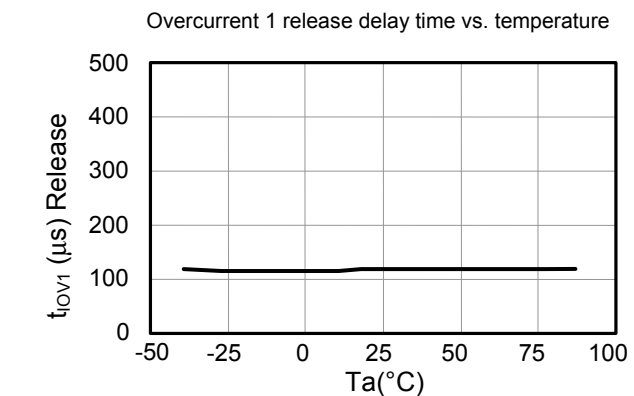
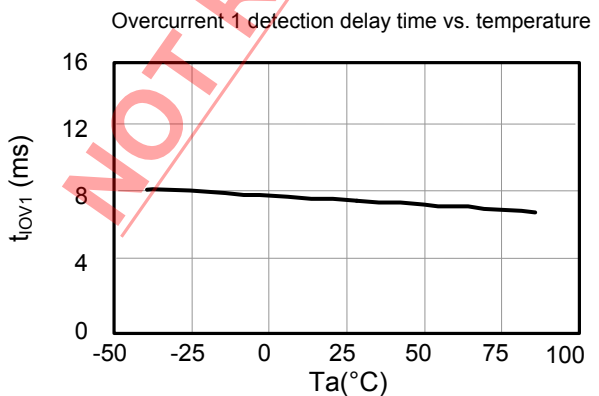
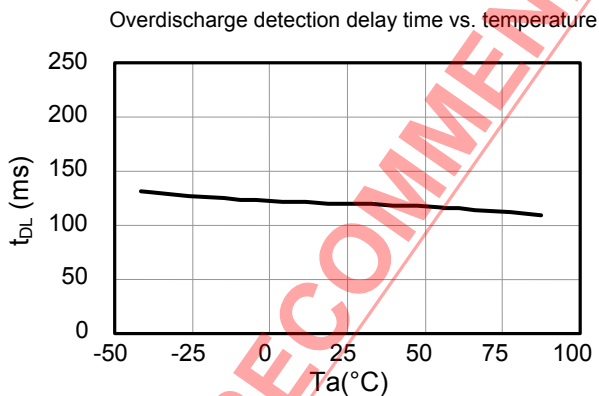
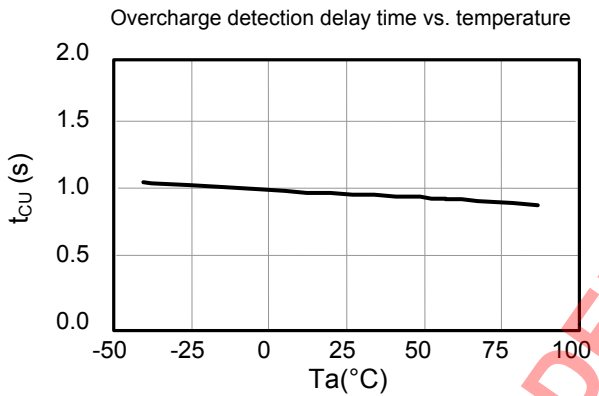



5. Delay time power-voltage characteristics (Ta = 25°C)



6. CO pin/DO pin output current characteristics (Ta = 25°C)



NOT RECOMMENDED FOR NEW DESIGN



No. MP005-A-P-SD-1.2

TITLE	SOT235-A-PKG Dimensions
No.	MP005-A-P-SD-1.2
SCALE	
UNIT	mm
Seiko Instruments Inc.	





No. MP005-A-C-SD-2.1

TITLE	SOT235-A-Carrier Tape
No.	MP005-A-C-SD-2.1
SCALE	
UNIT	mm
Seiko Instruments Inc.	



Enlarged drawing in the central part



No. MP005-A-R-SD-1.1

TITLE	SOT235-A-Reel		
No.	MP005-A-R-SD-1.1		
SCALE		QTY.	3,000
UNIT	mm		
Seiko Instruments Inc.			



No. PG006-A-P-SD-2.0

TITLE	SNT-6A-A-PKG Dimensions
No.	PG006-A-P-SD-2.0
SCALE	
UNIT	mm
Seiko Instruments Inc.	

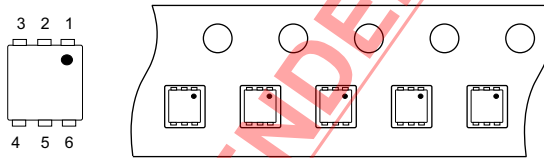

Feed direction →

No. PG006-A-C-SD-1.0

TITLE	SNT-6A-A-Carrier Tape
No.	PG006-A-C-SD-1.0
SCALE	
UNIT	mm
Seiko Instruments Inc.	



Enlarged drawing in the central part



No. PG006-A-R-SD-1.0

NOT RECOMMENDED FOR NEW DESIGN

TITLE	SNT-6A-A-Reel		
No.	PG006-A-R-SD-1.0		
SCALE		QTY.	5,000
UNIT	mm		
Seiko Instruments Inc.			



※1. ランドパターンの幅に注意してください (0.25 mm min. / 0.30 mm typ.).  
 ※2. パッケージ中央にランドパターンを広げないでください (1.30 mm ~ 1.40 mm)。

- 注意
1. パッケージのモールド樹脂下にシルク印刷やハンダ印刷などしないでください。
  2. パッケージ下の配線上のソルダーレジストなどの厚みをランドパターン表面から0.03 mm以下にしてください。
  3. マスク開口サイズと開口位置はランドパターンと合わせてください。
  4. 詳細は "SNTパッケージ活用の手引き" を参照してください。

※1. Pay attention to the land pattern width (0.25 mm min. / 0.30 mm typ.).  
 ※2. Do not widen the land pattern to the center of the package ( 1.30 mm ~ 1.40 mm ).

- Caution**
1. Do not do silkscreen printing and solder printing under the mold resin of the package.
  2. The thickness of the solder resist on the wire pattern under the package should be 0.03 mm or less from the land pattern surface.
  3. Match the mask aperture size and aperture position with the land pattern.
  4. Refer to "SNT Package User's Guide" for details.

※1. 请注意焊盘模式的宽度 (0.25 mm min. / 0.30 mm typ.).  
 ※2. 请勿向封装中间扩展焊盘模式 (1.30 mm ~ 1.40 mm)。

- 注意
1. 请勿在树脂型封装的下面印刷丝网、焊锡。
  2. 在封装下、布线上的阻焊膜厚度 (从焊盘模式表面起) 请控制在0.03 mm以下。
  3. 掩膜的开口尺寸和开口位置请与焊盘模式对齐。
  4. 详细内容请参阅 "SNT封装的应用指南"。

No. PG006-A-L-SD-4.0

TITLE	SNT-6A-A-Land Recommendation
No.	PG006-A-L-SD-4.0
SCALE	
UNIT	mm
Seiko Instruments Inc.	



Seiko Instruments Inc.  
[www.sii-ic.com](http://www.sii-ic.com)

- The information described herein is subject to change without notice.
- Seiko Instruments Inc. is not responsible for any problems caused by circuits or diagrams described herein whose related industrial properties, patents, or other rights belong to third parties. The application circuit examples explain typical applications of the products, and do not guarantee the success of any specific mass-production design.
- When the products described herein are regulated products subject to the Wassenaar Arrangement or other agreements, they may not be exported without authorization from the appropriate governmental authority.
- Use of the information described herein for other purposes and/or reproduction or copying without the express permission of Seiko Instruments Inc. is strictly prohibited.
- The products described herein cannot be used as part of any device or equipment affecting the human body, such as exercise equipment, medical equipment, security systems, gas equipment, vehicle equipment, in-vehicle equipment, aviation equipment, aerospace equipment, and nuclear-related equipment, without prior written permission of Seiko Instruments Inc.
- The products described herein are not designed to be radiation-proof.
- Although Seiko Instruments Inc. exerts the greatest possible effort to ensure high quality and reliability, the failure or malfunction of semiconductor products may occur. The user of these products should therefore give thorough consideration to safety design, including redundancy, fire-prevention measures, and malfunction prevention, to prevent any accidents, fires, or community damage that may ensue.

# Mouser Electronics

Authorized Distributor

Click to View Pricing, Inventory, Delivery & Lifecycle Information:

## ABLIC:

[S-8241ABCMC-GBCT2G](#) [S-8241ABHMC-GBHT2G](#) [S-8241ACHMC-GCHT2G](#) [S-8241ABBMC-GBBT2G](#) [S-8241ABQMC-GBQT2G](#) [S-8241ABUMC-GBUT2G](#) [S-8241ABVMC-GBVT2G](#) [S-8241ABWMC-GBWT2G](#) [S-8241ABXMC-GBXT2G](#) [S-8241ABYMC-GBYT2G](#) [S-8241ACAMC-GCAT2G](#) [S-8241ACBMC-GCBT2G](#) [S-8241ACDMC-GCDT2G](#) [S-8241ACEMC-GCET2G](#) [S-8241ACFMC-GCFT2G](#) [S-8241ACGMC-GCGT2G](#) [S-8241ACIMC-GCIT2G](#) [S-8241ACKMC-GCKT2G](#) [S-8241ACLMC-GCLT2G](#) [S-8241ACNMC-GCNT2G](#) [S-8241ACOMC-GCOT2G](#) [S-8241ACPMC-GCPT2G](#) [S-8241ACQMC-GCQT2G](#) [S-8241ACRMC-GRCT2G](#) [S-8241ACSMC-GCST2G](#) [S-8241ACTMC-GCTT2G](#) [S-8241ACUMC-GCUT2G](#) [S-8241ACWMC-GCWT2G](#) [S-8241ACXMC-GCXT2G](#) [S-8241ACYMC-GCYT2G](#) [S-8241ADAMC-GDAT2G](#) [S-8241ABPMC-GBPT2G](#) [S-8241ABFMC-GBFT2G](#) [S-8241ABKMC-GBKT2G](#) [S-8241ABLMC-GBLT2G](#) [S-8241ABEMC-GBET2G](#) [S-8241ABDMC-GBDT2G](#) [S-8241ABIMC-GBIT2G](#) [S-8241ABOMC-GBOT2G](#) [S-8241ABAMC-GBAT2G](#) [S-8241ABGMC-GBGT2G](#) [S-8241ADSMC-GDST2G](#) [S-8241AECMC-GECT2G](#) [S-8241AEEMC-GEET2G](#) [S-8241ABRMC-GBRT2G](#) [S-8241ABTMC-GBTT2G](#) [S-8241ADDMC-GDDT2G](#) [S-8241ADEMC-GDET2G](#) [S-8241ADFCMC-GDFT2G](#) [S-8241ADGMC-GDGT2G](#) [S-8241ADLMC-GDLT2G](#) [S-8241ADMMC-GDMT2G](#) [S-8241ADNMC-GDNT2G](#) [S-8241ADOMC-GDOT2G](#) [S-8241ADQMC-GDQT2G](#) [S-8241ADTMC-GDTT2G](#) [S-8241ADVMC-GDVT2G](#) [S-8241ADWMC-GDWT2G](#) [S-8241ADYMC-GDYT2G](#)



Компания «Life Electronics» занимается поставками электронных компонентов импортного и отечественного производства от производителей и со складов крупных дистрибьюторов Европы, Америки и Азии.

С конца 2013 года компания активно расширяет линейку поставок компонентов по направлению коаксиальный кабель, кварцевые генераторы и конденсаторы (керамические, пленочные, электролитические), за счёт заключения дистрибьюторских договоров

Мы предлагаем:

- Конкурентоспособные цены и скидки постоянным клиентам.
- Специальные условия для постоянных клиентов.
- Подбор аналогов.
- Поставку компонентов в любых объемах, удовлетворяющих вашим потребностям.
- Приемлемые сроки поставки, возможна ускоренная поставка.
- Доставку товара в любую точку России и стран СНГ.
- Комплексную поставку.
- Работу по проектам и поставку образцов.
- Формирование склада под заказчика.
- Сертификаты соответствия на поставляемую продукцию (по желанию клиента).
- Тестирование поставляемой продукции.
- Поставку компонентов, требующих военную и космическую приемку.
- Входной контроль качества.
- Наличие сертификата ISO.

В составе нашей компании организован Конструкторский отдел, призванный помогать разработчикам, и инженерам.

Конструкторский отдел помогает осуществить:

- Регистрацию проекта у производителя компонентов.
- Техническую поддержку проекта.
- Защиту от снятия компонента с производства.
- Оценку стоимости проекта по компонентам.
- Изготовление тестовой платы монтаж и пусконаладочные работы.



Тел: +7 (812) 336 43 04 (многоканальный)

Email: [org@lifeelectronics.ru](mailto:org@lifeelectronics.ru)