

SmartSlice CompoNet Communications Unit GRT1-CRT

The CompoNet-compliant unit can interface up to 256 inputs and 256 outputs at one node.

- Connects to up to 64 SmartSlice I/O Units.
- Concentrate I/O at one Slave: Up to 256 inputs and 256 outputs.
- Mix different I/O types at one Slave to help save space.
- Just set the node address for easy startup.
- Replace SmartSlice I/O Units online while continuing communications, minimizing system downtime.
- Smart function provided to monitor operating status, facilitating preventive maintenance and increasing operating rates.
- Register dummy SmartSlice I/O to reduce design work for future expansions.



Ordering Information

Name	Specifications	Model
CompoNet Communications Unit	Connects to up to 64 SmartSlice I/O Units (Inputs: 32 bytes maximum, Outputs: 32 bytes maximum)	GRT1-CRT

Specifications

Item	Model	GRT1-DRT
Network power supply voltage		14 to 26.4 V DC
Unit power supply voltage		20.4 to 26.4 V DC (24 V +10%/–15%)
I/O power supply voltage		20.4 to 26.4 V DC * (24 V +10%/–15%)
Noise immunity		Conforms to IEC 61000-4-4, 2 kV (power line)
Vibration resistance+		10 to 60 Hz, 0.7-mm double amplitude 60 to 150 Hz: 50 m/s ²
Shock resistance		150 m/s ²
Dielectric strength		500 V AC between isolated circuits
Insulation resistance		20 MΩ min. between isolated circuits
Ambient operating temperature		–10 to 55°C (with no icing or condensation)
Ambient operating humidity		25% to 85%
Ambient operating environment		No corrosive gases
Ambient storage temperature		–25 to 65°C (with no icing or condensation)
Mounting method		35-mm DIN track mounting

* For power supply input to the Slice I/O Units.

Specifications of the CompoNet Communications Unit

Item	Specification
I/O points	Inputs: 32 bytes maximum (including status and areas which the Unit does not use) Output: 32 bytes maximum (including areas which the Unit does not use)
Maximum number of SmartSlice I/O Units	64 (Do not count the End Unit.)
Status area	1 word (This word shows the status of the CompoNet Communications Unit.)
Parameter backup and restore	You can back up or restore a maximum of 2 KB of data for one CompoNet Communications Unit.
Baud rate	The CompoNet Communications Unit uses the baud rate of the CompoNet Master Unit (93.75 kbps, 1.5 Mbps, 3 Mbps, or 4 Mbps).
Communications media	You can use these cables: Round Cable I (JIS C 3306, VCTF 2-core 0.75-mm ² twisted-pair cable) Round Cable II (JIS C 3306, VCTF 4-core 0.75-mm ² twisted-pair cable) Flat Cable I (without sheath, DCA4-4F10) Note: The Round Cable I, Round Cable II and Flat Cable I are different types of cable. You must use a Repeater to divide a branch line from the main line to use more than one type of cable.
Indicators	MS (green/red): This indicator shows the status of the CompoNet Communications Unit. NS (green/red): This indicator shows the communications status of the CompoNet network. TS (green/red): This indicator shows the status of the SmartSlice I/O Terminal. UNIT PWR (green): This indicator shows the status of the Unit power supply. I/O PWR (green): This indicator shows the status of the I/O power supply.
Switches	Rotary switches: There are two rotary switches. You use them to set the node address. DIP switch: There is one DIP switch with four pins. You use them to set the operating mode.
Connectors	There is one CompoNet communications connector.
Terminals	Clamp terminals for Unit power supply (24 VDC) Clamp terminals for I/O power supply (24 VDC)
Power consumption	2.5 W
Power consumption for each SmartSlice I/O Terminal block	80 W max. (You must divide the I/O Terminal into blocks to use more than 80 W.)
SmartSlice I/O Terminal blocks	Main block and a maximum of two expansion blocks
Current consumption for I/O power supply	4 A max.
Weight	137 g
Accessories	None





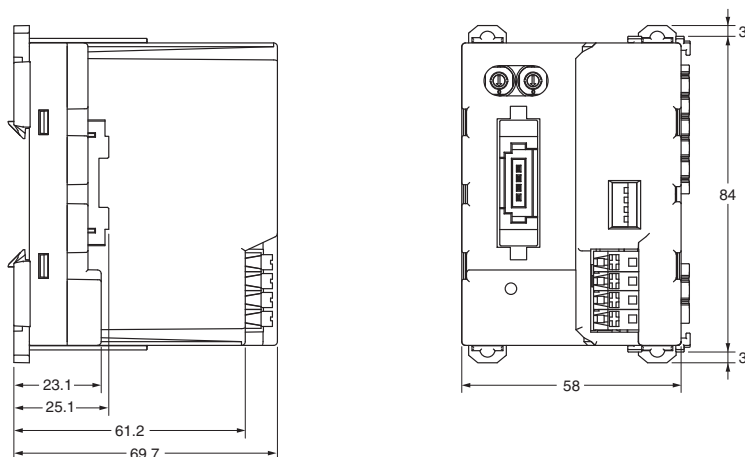

Dimensions

(Unit: mm)

GRT1-CRT



SmartSlice Ordering Information

Name		Appearance	Specifications	Model
CompoNet Communication Unit			Up to 64 Slice I/O Units can be connected (Inputs: 32 bytes maximum, Output: 32 bytes maximum)	GRT1-CRT
Slice I/O Units	Digital I/O Units		4 inputs NPN	GRT1-ID4
			4 inputs PNP	GRT1-ID4-1
			4 outputs NPN	GRT1-OD4
			4 outputs PNP	GRT1-OD4-1
			8 inputs NPN	GRT1-ID8
			8 inputs PNP	GRT1-ID8-1
			8 outputs NPN	GRT1-OD8
			8 outputs PNP	GRT1-OD8-1
			Relay Outputs 2 points	GRT1-ROS2
			AC Input 4 points	GRT1-IA4-1 GRT1-IA4-2
	Analog I/O Units		Analog inputs (current/voltage)	GRT1-AD2
			Analog outputs (current)	GRT1-DA2C
			Analog output (voltage)	GRT1-DA2V
	Temperature Input (Resistance Thermometers)		Temperature input (Resistance thermometer:Pt100) 2 points	GRT1-TS2P
			Temperature input (Resistance thermometer:Pt1000) 2 points	GRT1-TS2PK
Thermocouple Input 2 points			GRT1-TS2T	
Counter Units		Counter inputs: 1, External outputs: 1 NPN	GRT1-CT1	
		Counter inputs: 1, External outputs: 1 PNP	GRT1-CT1-1	
System Units	Turnback Units		Right Turnback Unit (Mounts to the right side of Slice I/O Terminal.)	GRT1-TBR
			Left Turnback Unit (Mounts to the left side of Slice I/O Terminal. Can supply power to I/O Units.)	GRT1-TBL
	Turnback Cable *1	---	1 m	GCN2-100
	I/O Power Feed Unit		Use when the total current consumption of the I/O Power Supply exceeds 4 A, or to make the I/O Power Supply a separate system.	GRT1-PD2
				GRT1-PD2G
				GRT1-PD8
GRT1-PD8-1				
End Unit *2		Use to add V/G terminals for I/O power supply.	GRT1-PC8	
			GRT1-PC8-1	
Option	Terminal Block	---	Package of 5 Terminal Blocks	GRT1-BT1-5

*1 Use the Turnback Cable together with the Turnback Units.

*2 The End Unit is sold separately. It is not provided with the Communications Unit.

Read and Understand This Catalog

Please read and understand this catalog before purchasing the products. Please consult your OMRON representative if you have any questions or comments.

Warranty and Limitations of Liability

WARRANTY

OMRON's exclusive warranty is that the products are free from defects in materials and workmanship for a period of one year (or other period if specified) from date of sale by OMRON.

OMRON MAKES NO WARRANTY OR REPRESENTATION, EXPRESS OR IMPLIED, REGARDING NON-INFRINGEMENT, MERCHANTABILITY, OR FITNESS FOR PARTICULAR PURPOSE OF THE PRODUCTS. ANY BUYER OR USER ACKNOWLEDGES THAT THE BUYER OR USER ALONE HAS DETERMINED THAT THE PRODUCTS WILL SUITABLY MEET THE REQUIREMENTS OF THEIR INTENDED USE. OMRON DISCLAIMS ALL OTHER WARRANTIES, EXPRESS OR IMPLIED.

LIMITATIONS OF LIABILITY

OMRON SHALL NOT BE RESPONSIBLE FOR SPECIAL, INDIRECT, OR CONSEQUENTIAL DAMAGES, LOSS OF PROFITS OR COMMERCIAL LOSS IN ANY WAY CONNECTED WITH THE PRODUCTS, WHETHER SUCH CLAIM IS BASED ON CONTRACT, WARRANTY, NEGLIGENCE, OR STRICT LIABILITY.

In no event shall the responsibility of OMRON for any act exceed the individual price of the product on which liability is asserted.

IN NO EVENT SHALL OMRON BE RESPONSIBLE FOR WARRANTY, REPAIR, OR OTHER CLAIMS REGARDING THE PRODUCTS UNLESS OMRON'S ANALYSIS CONFIRMS THAT THE PRODUCTS WERE PROPERLY HANDLED, STORED, INSTALLED, AND MAINTAINED AND NOT SUBJECT TO CONTAMINATION, ABUSE, MISUSE, OR INAPPROPRIATE MODIFICATION OR REPAIR.

Application Considerations

SUITABILITY FOR USE

OMRON shall not be responsible for conformity with any standards, codes, or regulations that apply to the combination of products in the customer's application or use of the products.

At the customer's request, OMRON will provide applicable third party certification documents identifying ratings and limitations of use that apply to the products. This information by itself is not sufficient for a complete determination of the suitability of the products in combination with the end product, machine, system, or other application or use.

The following are some examples of applications for which particular attention must be given. This is not intended to be an exhaustive list of all possible uses of the products, nor is it intended to imply that the uses listed may be suitable for the products:

- Outdoor use, uses involving potential chemical contamination or electrical interference, or conditions or uses not described in this catalog.
- Nuclear energy control systems, combustion systems, railroad systems, aviation systems, medical equipment, amusement machines, vehicles, safety equipment, and installations subject to separate industry or government regulations.
- Systems, machines, and equipment that could present a risk to life or property.

Please know and observe all prohibitions of use applicable to the products.

NEVER USE THE PRODUCTS FOR AN APPLICATION INVOLVING SERIOUS RISK TO LIFE OR PROPERTY WITHOUT ENSURING THAT THE SYSTEM AS A WHOLE HAS BEEN DESIGNED TO ADDRESS THE RISKS, AND THAT THE OMRON PRODUCTS ARE PROPERLY RATED AND INSTALLED FOR THE INTENDED USE WITHIN THE OVERALL EQUIPMENT OR SYSTEM.

PROGRAMMABLE PRODUCTS

OMRON shall not be responsible for the user's programming of a programmable product, or any consequence thereof.

Disclaimers

CHANGE IN SPECIFICATIONS

Product specifications and accessories may be changed at any time based on improvements and other reasons.

It is our practice to change model numbers when published ratings or features are changed, or when significant construction changes are made. However, some specifications of the products may be changed without any notice. When in doubt, special model numbers may be assigned to fix or establish key specifications for your application on your request. Please consult with your OMRON representative at any time to confirm actual specifications of purchased products.

DIMENSIONS AND WEIGHTS

Dimensions and weights are nominal and are not to be used for manufacturing purposes, even when tolerances are shown.

PERFORMANCE DATA

Performance data given in this catalog is provided as a guide for the user in determining suitability and does not constitute a warranty. It may represent the result of OMRON's test conditions, and the users must correlate it to actual application requirements. Actual performance is subject to the OMRON Warranty and Limitations of Liability.

ERRORS AND OMISSIONS

The information in this document has been carefully checked and is believed to be accurate; however, no responsibility is assumed for clerical, typographical, or proofreading errors, or omissions.

2011.12

In the interest of product improvement, specifications are subject to change without notice.

OMRON Corporation
Industrial Automation Company

<http://www.ia.omron.com/>

(c)Copyright OMRON Corporation 2011 All Right Reserved.

Компания «Life Electronics» занимается поставками электронных компонентов импортного и отечественного производства от производителей и со складов крупных дистрибьюторов Европы, Америки и Азии.

С конца 2013 года компания активно расширяет линейку поставок компонентов по направлению коаксиальный кабель, кварцевые генераторы и конденсаторы (керамические, пленочные, электролитические), за счёт заключения дистрибьюторских договоров

Мы предлагаем:

- Конкурентоспособные цены и скидки постоянным клиентам.
- Специальные условия для постоянных клиентов.
- Подбор аналогов.
- Поставку компонентов в любых объемах, удовлетворяющих вашим потребностям.
- Приемлемые сроки поставки, возможна ускоренная поставка.
- Доставку товара в любую точку России и стран СНГ.
- Комплексную поставку.
- Работу по проектам и поставку образцов.
- Формирование склада под заказчика.
- Сертификаты соответствия на поставляемую продукцию (по желанию клиента).
- Тестирование поставляемой продукции.
- Поставку компонентов, требующих военную и космическую приемку.
- Входной контроль качества.
- Наличие сертификата ISO.

В составе нашей компании организован Конструкторский отдел, призванный помогать разработчикам, и инженерам.

Конструкторский отдел помогает осуществить:

- Регистрацию проекта у производителя компонентов.
- Техническую поддержку проекта.
- Защиту от снятия компонента с производства.
- Оценку стоимости проекта по компонентам.
- Изготовление тестовой платы монтаж и пусконаладочные работы.



Тел: +7 (812) 336 43 04 (многоканальный)

Email: org@lifeelectronics.ru