

MMBTA92L, SMMBTA92L, MMBTA93L

High Voltage Transistors

PNP Silicon

Features

- S Prefix for Automotive and Other Applications Requiring Unique Site and Control Change Requirements; AEC-Q101 Qualified and PPAP Capable
- These Devices are Pb-Free, Halogen Free/BFR Free and are RoHS Compliant

MAXIMUM RATINGS

Rating	Symbol	92	93	Unit
Collector–Emitter Voltage	V_{CEO}	-300	-200	Vdc
Collector–Base Voltage	V_{CBO}	-300	-200	Vdc
Emitter–Base Voltage	V_{EBO}	-5.0	-5.0	Vdc
Collector Current — Continuous	I_C	-500		mAdc

DEVICE MARKING

MMBTA92L, SMMBTA92L = 2D; MMBTA93LT1 = 2E

THERMAL CHARACTERISTICS

Characteristic	Symbol	Max	Unit
Total Device Dissipation FR-5 Board (Note 1) $T_A = 25^\circ\text{C}$ Derate above 25°C	P_D	225	mW
		1.8	mW/ $^\circ\text{C}$
Thermal Resistance, Junction to Ambient	$R_{\theta JA}$	556	$^\circ\text{C}/\text{W}$
Total Device Dissipation (Note 2) Alumina Substrate, $T_A = 25^\circ\text{C}$ Derate above 25°C	P_D	300	mW
		2.4	mW/ $^\circ\text{C}$
Thermal Resistance, Junction to Ambient	$R_{\theta JA}$	417	$^\circ\text{C}/\text{W}$
Junction and Storage Temperature	T_J, T_{stg}	-55 to +150	$^\circ\text{C}$

Stresses exceeding Maximum Ratings may damage the device. Maximum Ratings are stress ratings only. Functional operation above the Recommended Operating Conditions is not implied. Extended exposure to stresses above the Recommended Operating Conditions may affect device reliability.

1. FR-5 = 1.0 x 0.75 x 0.062 in.

2. Alumina = 0.4 x 0.3 x 0.024 in. 99.5% alumina.



ON Semiconductor®

<http://onsemi.com>

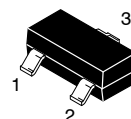
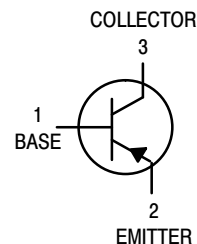

SOT-23 (TO-236AF)
CASE 318
STYLE 6

MARKING DIAGRAM

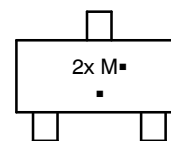

2x = Specific Device Code
M = Date Code*
▪ = Pb-Free Package

(*Note: Microdot may be in either location)

*Date Code orientation and/or overbar may vary depending upon manufacturing location.

ORDERING INFORMATION

Device	Package	Shipping†
MMBTA92LT1G	SOT-23 (Pb-Free)	3000 / Tape & Reel
SMMBTA92LT1G	SOT-23 (Pb-Free)	3000 / Tape & Reel
MMBTA92LT3G	SOT-23 (Pb-Free)	10000 / Tape & Reel
SMMBTA92LT3G	SOT-23 (Pb-Free)	10000 / Tape & Reel
MMBTA93LT1G	SOT-23 (Pb-Free)	3000 / Tape & Reel

†For information on tape and reel specifications, including part orientation and tape sizes, please refer to our Tape and Reel Packaging Specifications Brochure, BRD8011/D.

MMBTA92L, SMMBTA92L, MMBTA93L

ELECTRICAL CHARACTERISTICS ($T_A = 25^\circ\text{C}$ unless otherwise noted)

Characteristic	Symbol	Min	Max	Unit
OFF CHARACTERISTICS				
Collector–Emitter Breakdown Voltage (Note 3) ($I_C = -1.0\text{ mA}$, $I_B = 0$)	$V_{(BR)CEO}$	-300 -200	-	Vdc
Collector–Base Breakdown Voltage ($I_C = -100\text{ }\mu\text{A}$, $I_E = 0$)	$V_{(BR)CBO}$	-300 -200	-	Vdc
Emitter–Base Breakdown Voltage ($I_E = -100\text{ }\mu\text{A}$, $I_C = 0$)	$V_{(BR)EBO}$	-5.0	-	Vdc
Collector Cutoff Current ($V_{CB} = -200\text{ Vdc}$, $I_E = 0$) ($V_{CB} = -160\text{ Vdc}$, $I_E = 0$)	I_{CBO}	-	-0.25 -0.25	μA
Emitter Cutoff Current ($V_{EB} = -3.0\text{ Vdc}$, $I_C = 0$)	I_{EBO}	-	-0.1	μA

ON CHARACTERISTICS (Note 3)

DC Current Gain ($I_C = -1.0\text{ mA}$, $V_{CE} = -10\text{ Vdc}$) ($I_C = -10\text{ mA}$, $V_{CE} = -10\text{ Vdc}$) ($I_C = -30\text{ mA}$, $V_{CE} = -10\text{ Vdc}$)	Both Types Both Types MMBTA92, SMMBTA92 MMBTA93	h_{FE}	25 40 25 25	- - - -	-
Collector–Emitter Saturation Voltage ($I_C = -20\text{ mA}$, $I_B = -2.0\text{ mA}$)	MMBTA92, SMMBTA92 MMBTA93	$V_{CE(sat)}$	- -	-0.5 -0.5	Vdc
Base–Emitter Saturation Voltage ($I_C = -20\text{ mA}$, $I_B = -2.0\text{ mA}$)		$V_{BE(sat)}$	-	-0.9	Vdc

SMALL-SIGNAL CHARACTERISTICS

Current–Gain — Bandwidth Product ($I_C = -10\text{ mA}$, $V_{CE} = -20\text{ Vdc}$, $f = 100\text{ MHz}$)		f_T	50	-	MHz
Collector–Base Capacitance ($V_{CB} = -20\text{ Vdc}$, $I_E = 0$, $f = 1.0\text{ MHz}$)	MMBTA92, SMMBTA92 MMBTA93	C_{cb}	- -	6.0 8.0	pF

3. Pulse Test: Pulse Width $\leq 300\text{ }\mu\text{s}$, Duty Cycle $\leq 2.0\%$.

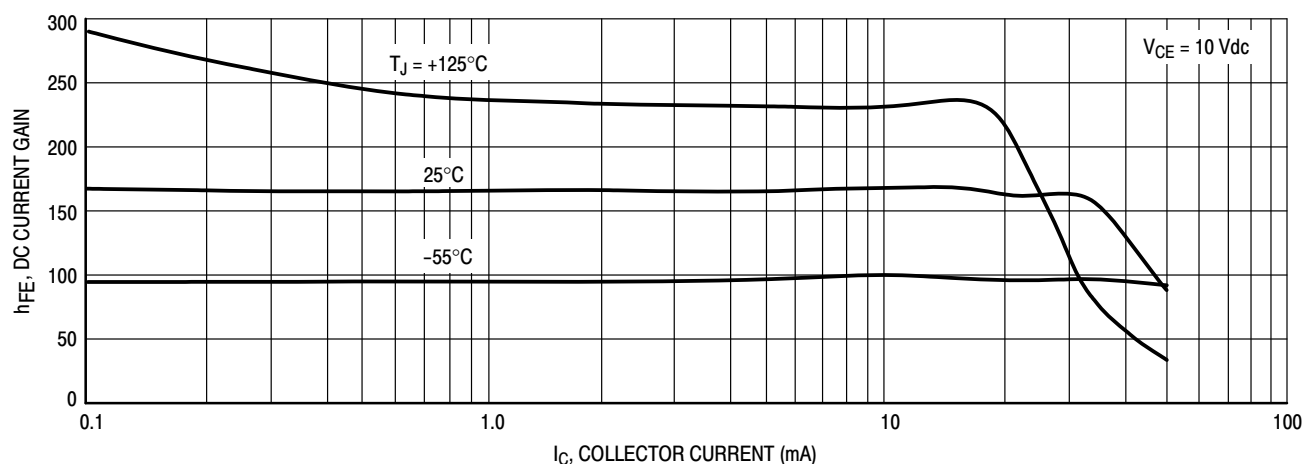

Figure 1. DC Current Gain

MMBTA92L, SMMBTA92L, MMBTA93L

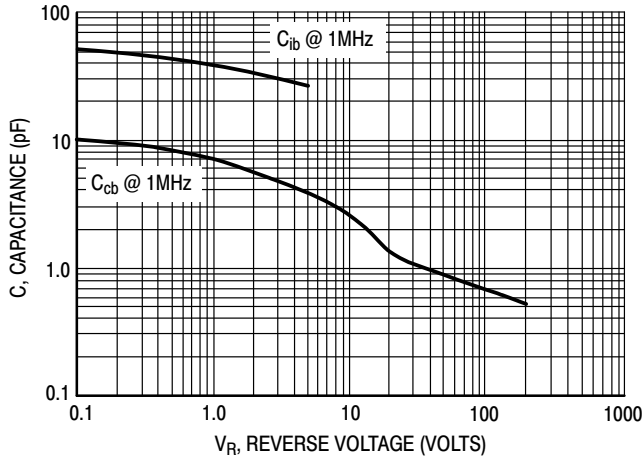

Figure 2. Capacitance

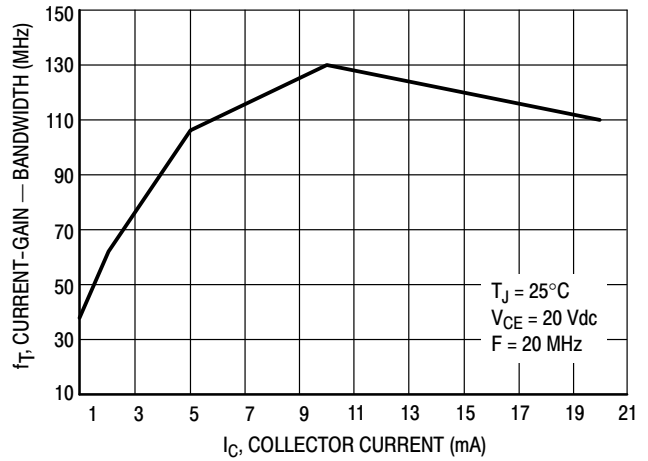

Figure 3. Current-Gain - Bandwidth

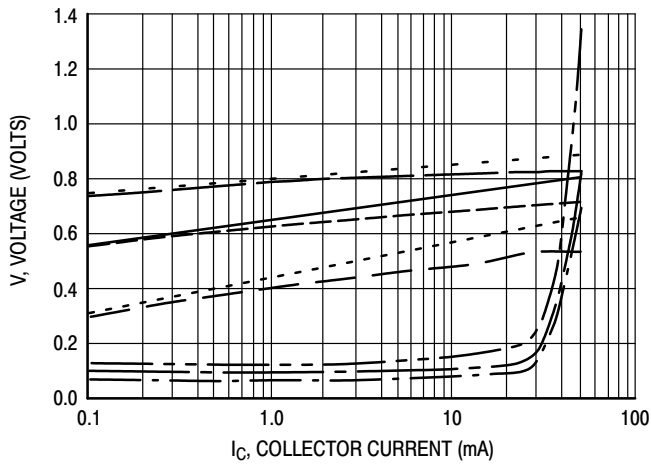

Figure 4. "ON" Voltages

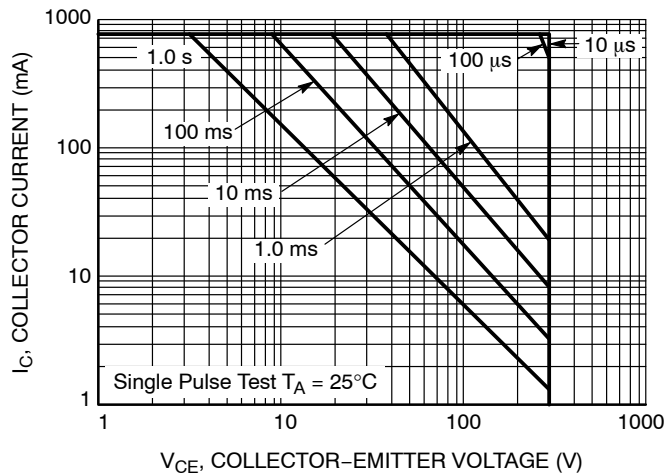
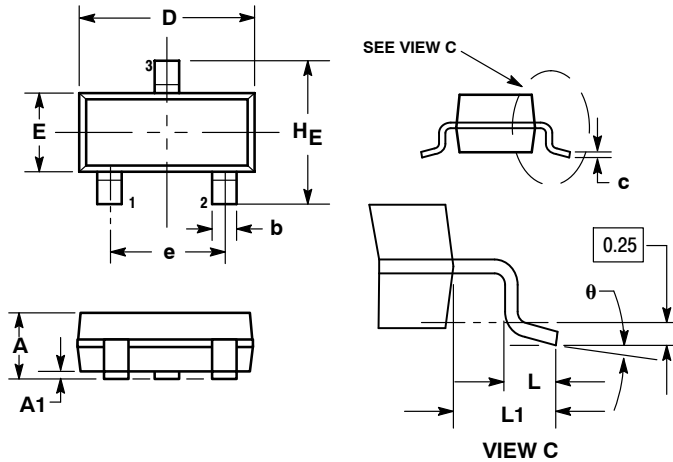

Figure 5. Safe Operating Area

MMBTA92L, SMMBTA92L, MMBTA93L

PACKAGE DIMENSIONS

SOT-23 (TO-236)
CASE 318-08
ISSUE AP



NOTES:

1. DIMENSIONING AND TOLERANCING PER ANSI Y14.5M, 1982.
2. CONTROLLING DIMENSION: INCH.
3. MAXIMUM LEAD THICKNESS INCLUDES LEAD FINISH THICKNESS. MINIMUM LEAD THICKNESS IS THE MINIMUM THICKNESS OF BASE MATERIAL.
4. DIMENSIONS D AND E DO NOT INCLUDE MOLD FLASH, PROTRUSIONS, OR GATE BURRS.

DIM	MILLIMETERS			INCHES		
	MIN	NOM	MAX	MIN	NOM	MAX
A	0.89	1.00	1.11	0.035	0.040	0.044
A1	0.01	0.06	0.10	0.001	0.002	0.004
b	0.37	0.44	0.50	0.015	0.018	0.020
c	0.09	0.13	0.18	0.003	0.005	0.007
D	2.80	2.90	3.04	0.110	0.114	0.120
E	1.20	1.30	1.40	0.047	0.051	0.055
e	1.78	1.90	2.04	0.070	0.075	0.081
L	0.10	0.20	0.30	0.004	0.008	0.012
L1	0.35	0.54	0.69	0.014	0.021	0.029
HE	2.10	2.40	2.64	0.083	0.094	0.104
θ	0°	---	10°	0°	---	10°

STYLE 6:

1. BASE
2. EMITTER
3. COLLECTOR

SOLDERING FOOTPRINT

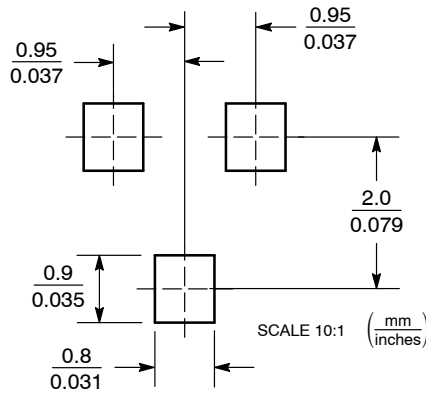

ON Semiconductor and **ON** are registered trademarks of Semiconductor Components Industries, LLC (SCILLC). SCILLC reserves the right to make changes without further notice to any products herein. SCILLC makes no warranty, representation or guarantee regarding the suitability of its products for any particular purpose, nor does SCILLC assume any liability arising out of the application or use of any product or circuit, and specifically disclaims any and all liability, including without limitation special, consequential or incidental damages. "Typical" parameters which may be provided in SCILLC data sheets and/or specifications can and do vary in different applications and actual performance may vary over time. All operating parameters, including "Typicals" must be validated for each customer application by customer's technical experts. SCILLC does not convey any license under its patent rights nor the rights of others. SCILLC products are not designed, intended, or authorized for use as components in systems intended for surgical implant into the body, or other applications intended to support or sustain life, or for any other application in which the failure of the SCILLC product could create a situation where personal injury or death may occur. Should Buyer purchase or use SCILLC products for any such unintended or unauthorized application, Buyer shall indemnify and hold SCILLC and its officers, employees, subsidiaries, affiliates, and distributors harmless against all claims, costs, damages, and expenses, and reasonable attorney fees arising out of, directly or indirectly, any claim of personal injury or death associated with such unintended or unauthorized use, even if such claim alleges that SCILLC was negligent regarding the design or manufacture of the part. SCILLC is an Equal Opportunity/Affirmative Action Employer. This literature is subject to all applicable copyright laws and is not for resale in any manner.

PUBLICATION ORDERING INFORMATION

LITERATURE FULFILLMENT:
Literature Distribution Center for ON Semiconductor
P.O. Box 5163, Denver, Colorado 80217 USA
Phone: 303-675-2175 or 800-344-3860 Toll Free USA/Canada
Fax: 303-675-2176 or 800-344-3867 Toll Free USA/Canada
Email: orderlit@onsemi.com

N. American Technical Support: 800-282-9855 Toll Free
USA/Canada
Europe, Middle East and Africa Technical Support:
Phone: 421 33 790 2910
Japan Customer Focus Center
Phone: 81-3-5817-1050

ON Semiconductor Website: www.onsemi.com
Order Literature: <http://www.onsemi.com/orderlit>
For additional information, please contact your local Sales Representative

Компания «Life Electronics» занимается поставками электронных компонентов импортного и отечественного производства от производителей и со складов крупных дистрибьюторов Европы, Америки и Азии.

С конца 2013 года компания активно расширяет линейку поставок компонентов по направлению коаксиальный кабель, кварцевые генераторы и конденсаторы (керамические, пленочные, электролитические), за счёт заключения дистрибьюторских договоров

Мы предлагаем:

- Конкуренспособные цены и скидки постоянным клиентам.
- Специальные условия для постоянных клиентов.
- Подбор аналогов.
- Поставку компонентов в любых объемах, удовлетворяющих вашим потребностям.
- Приемлемые сроки поставки, возможна ускоренная поставка.
- Доставку товара в любую точку России и стран СНГ.
- Комплексную поставку.
- Работу по проектам и поставку образцов.
- Формирование склада под заказчика.
- Сертификаты соответствия на поставляемую продукцию (по желанию клиента).
- Тестирование поставляемой продукции.
- Поставку компонентов, требующих военную и космическую приемку.
- Входной контроль качества.
- Наличие сертификата ISO.

В составе нашей компании организован Конструкторский отдел, призванный помогать разработчикам, и инженерам.

Конструкторский отдел помогает осуществить:

- Регистрацию проекта у производителя компонентов.
- Техническую поддержку проекта.
- Защиту от снятия компонента с производства.
- Оценку стоимости проекта по компонентам.
- Изготовление тестовой платы монтаж и пусконаладочные работы.



Тел: +7 (812) 336 43 04 (многоканальный)

Email: org@lifeelectronics.ru