

LC823450

Low Power & High-Resolution Audio Processing System LSI for Portable Sound Solution

LC823450 is audio processing system LSI for record and playback, and High-Resolution 32-bit & 192 kHz audio processing capable. It is possible to cover the most of functions necessary for a portable audio with only this LSI as follows.

It has Dual CPU and DSP with High processing capability, and internal 1656K-Byte SRAM, which make it possible to implement large scale program. And it has integrated analog functions so that PCB space and cost is reduced, and it has various interface to make extensibility high. Also it is provided with various function including SBC/AAC codec by DSP and UART and ASRC for Bluetooth® audio. It is very small chip size in spite of the multi-function as described above and it realizes the low power consumption. Therefore, it is applicable to portable audio markets such as Wireless headsets and will show high performance. This document describes features, basic functions, electrical specifications, characteristics, application diagram and package dimension of this LSI.

Features

- Ultra low power consumption
- ARM® Cortex®-M3 Dual Core
- Proprietary 32-bit DSP Core (LPDSP32)
- Internal large scale size SRAM : 1656 KB (1.5 MB + 120 KB)
- High-Resolution 32-bit & 192 kHz audio processing capability
- Several DSP codes available for audio functions
- Hard wired audio functions built-in
MP3 decoder, MP3 encoder
6 band Equalizer
Synchronous SRC, Asynchronous SRC, etc.
- Analog blocks built-in
System PLL, Audio PLL
16-bit DAC, Class-D amp, etc.
- USB2.0 device and USB2.0 host with a integrated PHY
eMMC and SD card I/F
Serial Flash I/F(Quad) with cache memory
SPI, UART, I²C, etc.

Typical Applications

- Sound Recorders
- Wearable Audio Players
- Bluetooth Headsets
- Smart Phone Accessories



ON Semiconductor®

www.onsemi.com

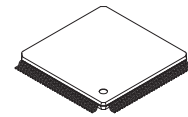

TQFP128 14x14 / TQFP128L
[LC823450TA-2H]

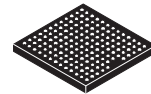

WLCSP154, 5.52x5.33
[LC823450XATBG, LC823450XBTBG,
LC823450XCTBG, LC823450XDTBG]

ORDERING INFORMATION

See detailed ordering and shipping information in the package dimensions section on page 55 of this data sheet.



1 Abstract

1-1 Features

- Cortex-M3 Dual Core, AMBA® (AHB/APB) system
 - Internal SRAM (1.5M-byte)
 - Internal ROM (256k-byte). Boot code, Standard Functions
 - SDRAM Controller (1 * CS)
64M to 256Mbit SDRAM / Mobile SDRAM
 - External Memory Controller (2 * CS)
NOR FLASH, SRAM, ROM supported, 8/16 bit I/F LCD controller supported
Internal ROM boot and External memory device boot available
 - DMA Controller (8ch)
 - Interrupt Controller (External 90ch, Internal 82ch)
 - SPI (1ch)
 - Serial Flash I/F (1ch)
Quad SPI, cache memory (16k-byte, 4way set associative, 128line) function available
1.8V dedicated power supply
 - UART (3ch)
UART1 : w/flow control (CTS, RTS)
UART0, UART2 : w/o flow control
 - I2C (2ch) Single Master, Full/Standard
 - GPIO (90 ch)
 - Plain Timer w/ Watch Dog Timer (1chx3)
 - Multiple Timer (2chx4)
 - 10bit ADC (6ch)
 - SD Card I/F (3ch)
eSD/eMMC, UHS-I, w/o CPRM
 - SD0 : eSD/eMMC boot supported (Internal ROM Boot function)
1.8V dedicated power supply
 - SD1 : Multiplexed w/ Memory Stick I/F
1.8V dedicated power supply
 - SD2 :
1.8V dedicated power supply
 - Memory Stick I/F (1ch)
Multiplexed w/ SD1
 - USB2.0 Host (HS/FS/LS) Controller, Device (HS/FS) Controller. Integrated PHY
Xtal (XT1) is required for USB function.
48 MHz for Host, and 12,20,24,48 MHz for device
w/o OTG function. Host and Device share an integrated PHY.
 - Real Time Clock
2 modes below are available
 - General RTC mode : RTC w/o key input
 - KeyInt RTC mode : RTC w/ key input which enables power on function
 - SWD (Serial Wire Debug) is supported as the debug interface
SWV (Serial Wire Viewer) is supported as the trace interface
Only one of Cortex-M3 Dual Core can be traced.

LC823450

1 Availability of features explained here depends on products.

- MP3¹ hard wired encoder/decoder
 - MP3 MPEG1, MPEG2, MPEG2.5
 - Sampling rate : 8kHz, 11.025kHz, 12kHz, 16kHz, 22.05kHz, 24kHz, 32kHz, 44.1kHz, 48kHz
 - Bit rate : 8 Kbps to 320 Kbps (Decoder-VBR supported)
- LPDSP32 system
 - Internal SRAM (120kbyte)
 - Internal ROM (220kbyte)
 - WMA² (Microsoft WMA Decoder Profile Level3)
 - Sampling rate : 8kHz, 11.025kHz, 16kHz, 22.05kHz, 32kHz, 44.1kHz, 48kHz
 - Bit rate : 5 Kbps to 320 Kbps (VBR supported)
 - AAC (MPEG4 LC-AAC)
 - Sampling rate : 8kHz, 11.025kHz, 12kHz, 16kHz, 22.05kHz, 24kHz, 32kHz, 44.1kHz, 48kHz
 - Bit rate : 8Kbps to 320Kbps (VBR supported)
 - Variable Speed Control playback (0.5 to 4.0 times speed)
 - While WMA and AAC playback, up to 2.0 time speed
 - While PCM playback, up to 4.0 times speed
 - While MP3 playback w/ hard wired decoder, up to 4.0 times speed
 - Noise Canceller, etc.
 - JTAG ICE
- Bluetooth Protocol Stack available³
- Other audio functions available
 - 6band Equalizer (EQ3)
 - Volume, Mute
 - Level Meter
 - Audio Timer w/ interrupt generation
 - 16/24/32bit 192 kHz PCM I/F (2chx2). Master/slave, I2S
 - SSRC (Synchronous Sampling Rate Converter)
 - 0.25 to 64 conversion capable
 - ASRC (Asynchronous Sampling Rate Converter)
 - jitter reducing function supporting USB audio class and Bluetooth streaming
 - Beep generator
 - Digital Microphone I/F (2chx1)
 - 16bit Audio DAC (2ch)
 - w/ Class-D Amplifier for Head Phone (2ch). Need external LC LPF
- Audio clock generation
 - Dedicated PLL for audio(PLL2:1V and PLL3:3V operation integrated)
 - Selectable PLL reference clock
 - XT1 (1 to 50MHz Main xtal)
 - XTRTC (32.768KHz RTC xtal)
 - PCM I/F MCLK0 (/MCLK1), BCK0, BCK1
- Power supply
 - Typical voltage
 - LOGIC(Vdd1), XT1(VddXT1), PLL1(AVddPLL1), PLL2(AVddPLL2) = 1.0V
 - PLL3(AVddPLL3) = 3.3V
 - RTC(VddRTC) = 1.0V
 - I/O(Vdd2) = 1.8V or 3.3V
 - SD0(VddSD0) = 1.8V or 3.3V
 - SD1(VddSD1) = 1.8V or 3.3V
 - SD2(VddSD2) = 1.8V or 3.3V
 - S-Flash I/F(VddQSPI) = 1.8V or 3.3V
 - ADC(AVddADC) = 3.3V
 - USB PHY1(AVddUSBPHY1, DVddUSBPHY1) = 1.0V(w/o USB connection) or 1.2V(w/ USB connection)
 - USB PHY2(AVddUSBPHY2) = 2.8V(w/o USB connection) or 3.3V(w/ USB connection)
 - Class-D Amplifier(AVddDAMPL, AVddDAMPR) = 1.2V

1 MPEG Layer-3 audio coding technology licensed from Fraunhofer IIS and Thomson.

Supply of this product does not convey license nor imply any right to distribute content created with this product in revenue-generating broadcast systems (terrestrial, satellite, cable and/or other distribution channels), streaming applications (via Internet, intranets and/or networks), other content distribution systems (pay-audio or audio-on-demand applications and the like) or on physical media (compact discs, digital versatile discs, semiconductor chips, hard drives, memory cards and the like). For details, please visit <http://mp3licensing.com/>

Supply of this product does not convey license under the relevant intellectual property of Thomson and/or Fraunhofer Gesellschaft nor imply any right to use this product in any finished end user or ready-to-use final product. An independent license for such use is required. For details, please visit <http://mp3licensing.com/>.

2 This product contain technology of Microsoft company ownership, and you cannot distribute or use without getting license from Microsoft Licensing company.

3 The product name for which Bluetooth Protocol Stack is available is determined. Refer to Page 4. Please contact our representative for license fee for the Stack.

Copyright 1999-2014 OpenSynergy GmbH

All rights reserved. All unpublished rights reserved.

1-2 Device naming rule

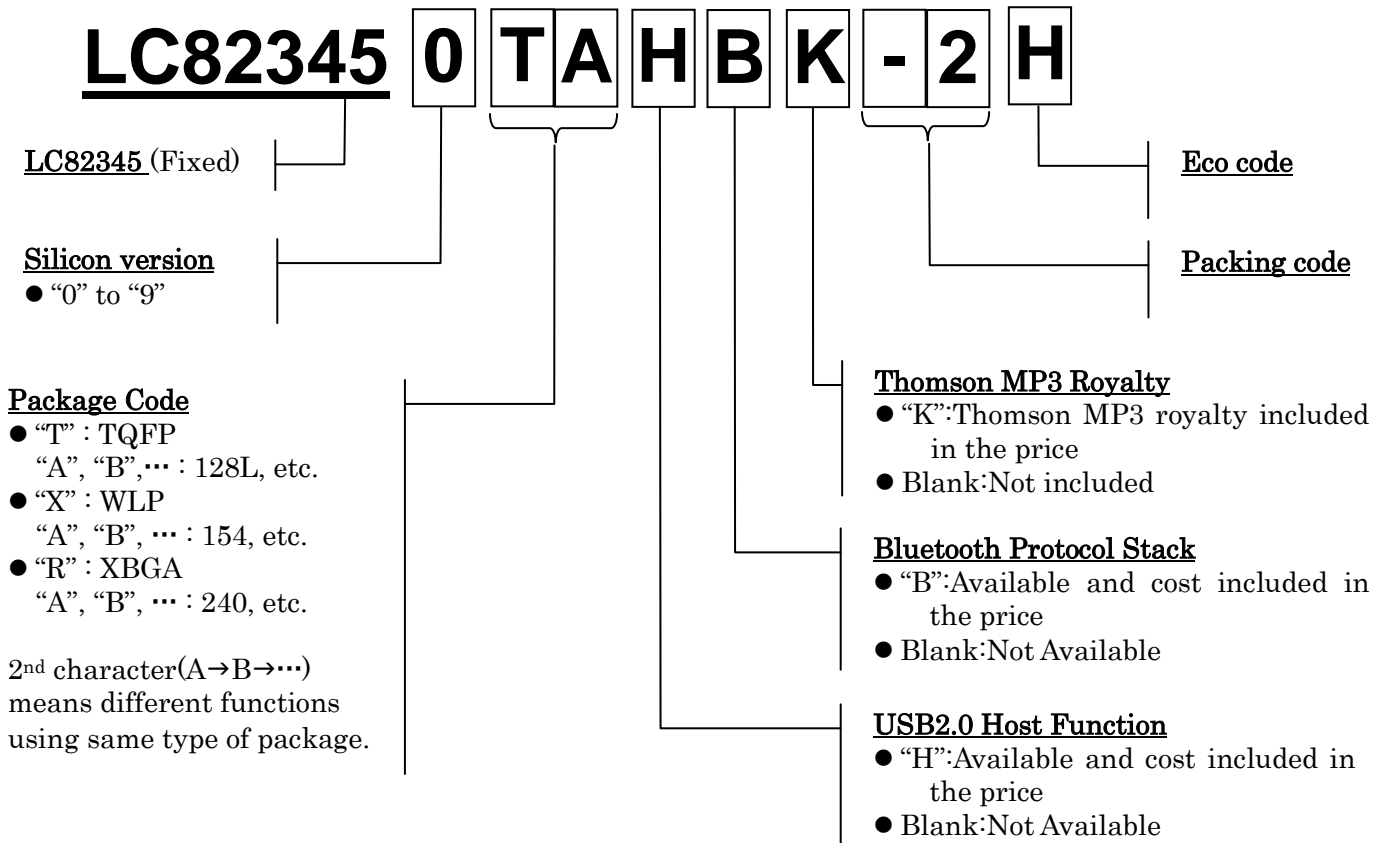

1-3 Package Code and Functional Difference

The product of Package Code="RA" is under planning

Table of Functional Difference				
Function	Package Code			
	TA	XA, XC	XB, XD	RA
Package	TQFP128L	WLP154		XBGA240
Cortex-M3 Dual Core	Single	Single	Dual	Dual
SDRAM Controller				Available
External Memory Controller		8bit I/F (LCD I/F, etc.)	8bit I/F (LCD I/F, etc.)	Available
SD2	Available		Available	Available
10bit ADC conversion speed	MAX 5MHz (*2)			MAX 20MHz (*4)
10bit ADC reference voltage	VRH=AVddADC VRL=AVssADC (*3)			VRH=AVddADC and lower VRL=AVssADC and higher
PCM1(PCM I/F ch1)	BCK1/LRCK1 share pins with other function	Available	Available	Available
MP3 hard wired encoder	Available		Available	Available
16bit Audio DAC, Class-D AMP	Available		Available	Available
PLL2(1V PLL) PLL3(3V PLL)	Only PLL2	Available	Available	Only PLL2
XTALINFO[1:0] input	"00" (24 MHz)	Available	Available	Available
RTCMODE input	"1" (General RTC mode)	Available	Available	Available
KEYINT[2:0] input		Available	Available	Available
External Interrupt	45 ch	61 ch	61 ch	90 ch
GPIO	45 ch	61 ch	61 ch	90 ch

[Note]

- Pin shared for multiple function. Refer to Terminal Functions for details.
- (*1) Intentionally not used
- (*2) VR is open inside
- (*3) VRH=AVddADC, VRL=AVssADC inside
- (*4) Decoupling capacitor is required.
MAX 5MHz in case of open

LC823450

1-4 Block Diagram

1-4-1 Top

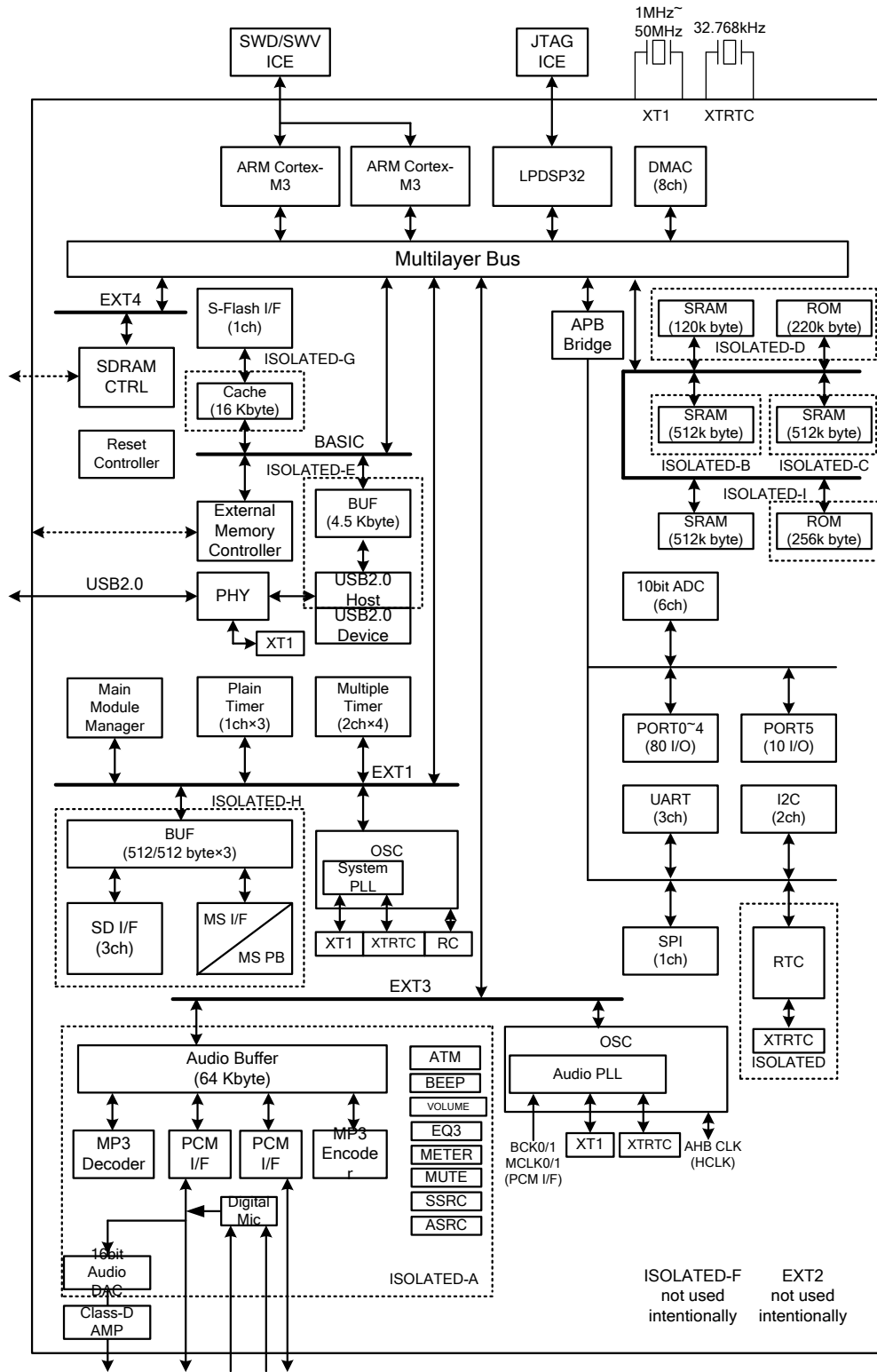

1-4-2 Bus Matrix

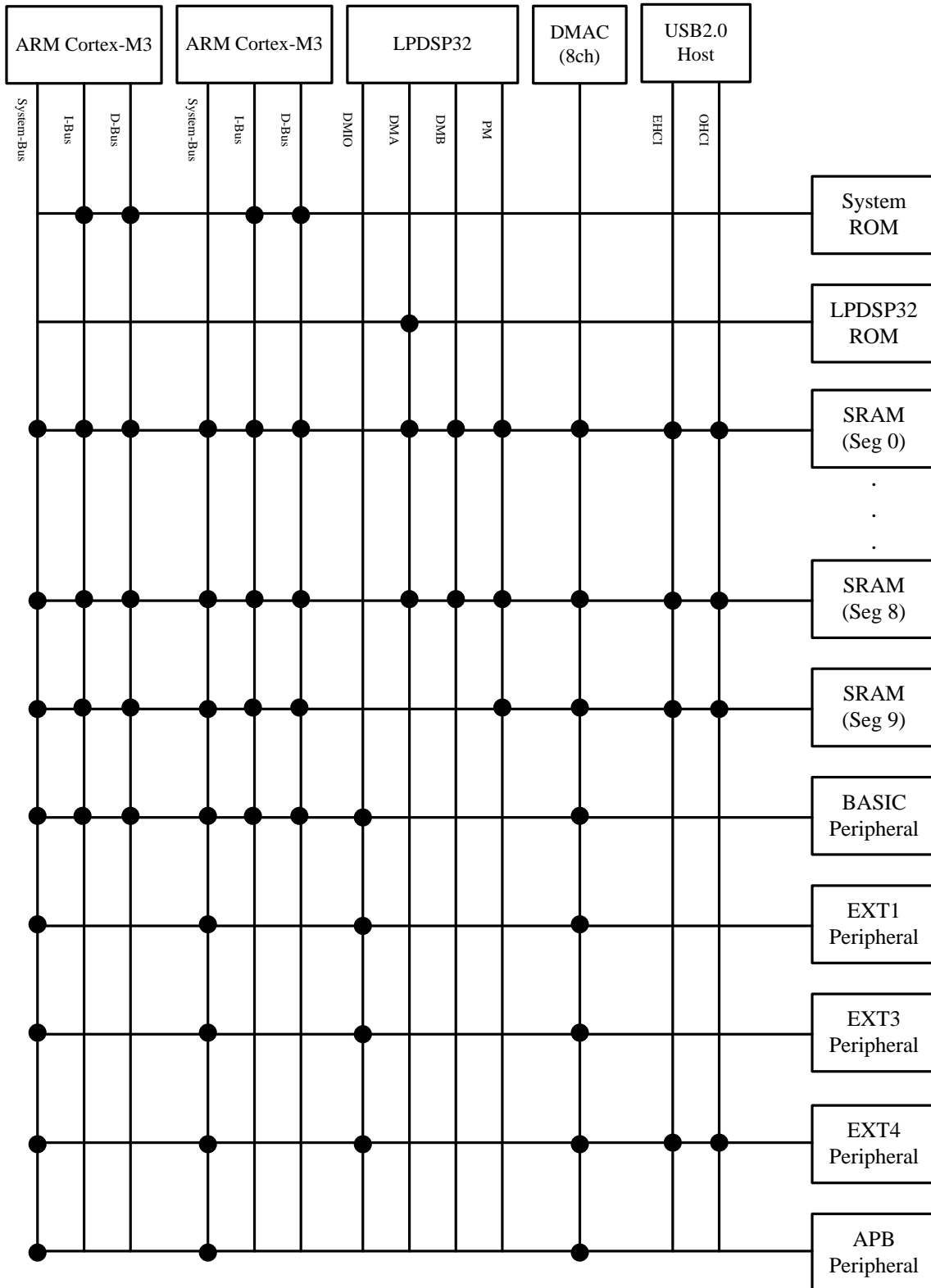

LC823450

2 Terminal Functions

TA : Package Code="TA"

XA : Package Code="XA"

XB : Package Code="XB"

XC : Package Code="XC"

XD : Package Code="XD"

(A) JTAG/SWD

Terminal name	Polarity	Direction	Function	IO POWER	Available(○)		
					TA	XA, XC	XB, XD
Multiplexed function							
TDO	–	O	JTAG test data output	VddSD1	○	○	○
SDWP1	Pos	I	SD I/F Ch1 write protect		○	○	○
INS	Neg	I	Memory Stick INS		○	○	○
GPIO21	–	B	GPIO		○	○	○
EXTINT21	–	I	External Interrupt 2-bit1		○	○	○
TDI	–	I	JTAG test data input	VddSD1	○	○	○
SDCD1	Neg	I	SD I/F Ch1 detect		○	○	○
SWO	–	O	serial wire view data		○	○	○
GPIO20	–	B	GPIO		○	○	○
EXTINT20	–	I	External Interrupt 2-bit0		○	○	○
TMS	–	I	JTAG test data select	VddSD2	○	○	○
SDWP2	Pos	I	SD I/F Ch2 write protect		○	(*)	○
GPIO28	–	B	GPIO		○	○	○
EXTINT28	–	I	External Interrupt 2-bit8		○	○	○
TCK	Pos	I	JTAG test clock	VddSD2	○	○	○
SDCD2	Neg	I	SD I/F Ch2 detect		○	(*)	○
GPIO29	–	B	GPIO		○	○	○
EXTINT29	–	I	External Interrupt 2-bit9		○	○	○
SWDCLK	Pos	I	Serial wire clock	Vdd2	○	○	○
DMCKO1	–	O	Digital MicCh1Clock Output		○	○	○
GPIO58	–	B	GPIO		○	○	○
EXTINT58	–	I	External Interrupt 5-bit8		○	○	○
SWDIO	–	B	Serial wire Data	Vdd2	○	○	○
DMDIN1	–	I	Digital MicCh1 Data Input		○	○	○
GPIO59	–	B	GPIO		○	○	○
EXTINT59	–	I	External Interrupt 5-bit9		○	○	○
Sum					6	6	6

(*) This function is not available

LC823450

(B) RTC

Terminal name	Polarity	Direction	Function	IO POWER	Available(○)		
					TA	XA, XC	XB, XD
Multiplexed function							
XIN32K	Pos	I	32.768kHz XTAL Input (XTRTC)	VddRTC	○	○	○
XOUT32K	–	O	32.768kHz XTAL Output (XTRTC)	VddRTC	○	○	○
VDET	Neg	I	RTC power detect Input	VddRTC	○	○	○
RTCINT	Neg	O	RTC Interrupt Output (Normal:Hiz, Interrupt enabled:Low Output)	VddRTC	○	○	○
BACKUPB	Neg	I	RTC backup mode input	VddRTC	○	○	○
KEYINT[2:0]	–	I	RTC KEY input can be used when KeyInt RTC mode	VddRTC		○	○
RTCMODE	–	I	RTC mode input(*1) Set General RTC or KeyInt RTC mode RTCMODE = · “0” : KeyInt RTC mode · “1” : General RTC mode Bonding internally for “TA” product	VddRTC		○	○
VddRTC	–	P	RTC power supply	–	○	○	○
VssRTC	–	P	RTC ground	–	○	○	○
Sum					7	11	11

(*1) Set according to the General RTC mode or KeyInt RTC mode.
Bonding internally for “TA” product as described on Page 5

LC823450

(C) External Interrupt/GPIO

Terminal name	Polarity	Direction	Function	IO POWER	Available(○)		
					TA	XA, XC	XB, XD
Multiplexed function							
SDRADDR12	–	O	SDRAM address	Vdd2			
GPIO2A	–	B	GPIO				
EXTINT2A	–	I	External Interrupt 2-bit10				
SCL1	–	O	I2C ch1 Clock (open drain output)	Vdd2	○	○	○
GPIO2B	–	B	GPIO		○	○	○
EXTINT2B	–	I	External Interrupt 2-bit11		○	○	○
SDA1	–	B	I2C ch1 Data (open drain output)	Vdd2	○	○	○
GPIO2C	–	B	GPIO		○	○	○
EXTINT2C	–	I	External Interrupt 2-bit12		○	○	○
SDRADDR11	–	O	SDRAM address	Vdd2			
DMCKO0	–	O	Digital Mic Clock Ch0 Output		○	○	○
GPIO2D	–	B	GPIO		○	○	○
EXTINT2D	–	I	External Interrupt 2-bit13		○	○	○
EXTINT2E	–	I	External Interrupt 2-bit14	Vdd2	○	○	○
GPIO2E	–	B	GPIO * While Internal ROM boot, this terminal is used as external power circuit enable signal.		○	○	○
EXTINT2F	–	I	External Interrupt 2-bit15	Vdd2	○	○	○
GPIO2F	–	B	GPIO * While Internal ROM boot, this terminal is used as boot monitor signal.		○	○	○
Sum					5	5	5

LC823450

(D) SPI(Serial I/F Ch0)/S-Flash I/F(Serial I/F Ch1)

Terminal name Multiplexed function	Polarity	Direction	Function	IO POWER	Available(○)		
					TA	XA, XC	XB, XD
SCK0	Neg	B	Serial I/F Ch0 Clock	Vdd2	○	○	○
GPIO1D	–	B	GPIO		○	○	○
EXTINT1D	–	I	External Interrupt 1-bit13		○	○	○
SDI0	–	I	Serial I/F Ch0 Data Input	Vdd2	○	○	○
GPIO1E	–	B	GPIO		○	○	○
EXTINT1E	–	I	External Interrupt 1-bit14		○	○	○
SDO0	–	O	Serial I/F Ch0 Data Output	Vdd2	○	○	○
GPIO1F	–	B	GPIO		○	○	○
EXTINT1F	–	I	External Interrupt 1-bit15		○	○	○
SCK1	Neg	O	Serial I/F Ch1 Clock (QSPI Clock)	VddQSPI	○	○	○
GPIO0D	–	B	GPIO		○	○	○
EXTINT0D	–	I	External Interrupt 0-bit13		○	○	○
SDI1(QIO0)	–	O(B)	Serial I/F Ch1 Data Output (QSPI Data 0)	VddQSPI	○	○	○
GPIO0E	–	B	GPIO		○	○	○
EXTINT0E	–	I	External Interrupt 0-bit14		○	○	○
SDO1(QIO1)	–	I(B)	Serial I/F Ch1 Data Input (QSPI Data 1)	VddQSPI	○	○	○
GPIO0F	–	B	GPIO		○	○	○
EXTINT0F	–	I	External Interrupt 0-bit15		○	○	○
SWP1(QIO2)	Neg	O(B)	Serial I/F Ch1 write protect (QSPI Data 2)	VddQSPI	○	○	○
GPIO11	–	B	GPIO		○	○	○
EXTINT11	–	I	External Interrupt 1-bit1		○	○	○
SHOLD1(QIO3)	Neg	O(B)	Serial I/F Ch1 hold (QSPI Data 3)	VddQSPI	○	○	○
GPIO12	–	B	GPIO		○	○	○
EXTINT12	–	I	External Interrupt 1-bit2		○	○	○
Sum					8	8	8

LC823450

(E) I2C

Terminal name Multiplexed function	Polarity	Direction	Function	IO POWER	Available(○)		
					TA	XA, XC	XB, XD
SCL0	–	O	I2C ch0 Clock (open drain output)	Vdd2	○	○	○
GPIO07	–	B	GPIO		○	○	○
EXTINT07	–	I	External Interrupt 0-bit7		○	○	○
SDA0	–	B	I2C ch0 Data (open drain output)	Vdd2	○	○	○
GPIO08	–	B	GPIO		○	○	○
EXTINT08	–	I	External Interrupt 0-bit8		○	○	○
Sum					2	2	2

(F) UART

Terminal name Multiplexed function	Polarity	Direction	Function	IO POWER	Available(○)		
					TA	XA, XC	XB, XD
TXD1	–	O	UART Ch1 transmit Data	VddSD2	○	○	○
SDAT20	–	B	SD I/F Ch2 Data 0		○	(*)	○
GPIO04	–	B	GPIO		○	○	○
EXTINT04	–	I	External Interrupt 0-bit4		○	○	○
RXD1	–	I	UART Ch1 receive Data	VddSD2	○	○	○
SDAT21	–	B	SD I/F Ch2 Data 1		○	(*)	○
GPIO05	–	B	GPIO		○	○	○
EXTINT05	–	I	External Interrupt 0-bit5		○	○	○
CTS1	Neg	I	UART Ch1 clear to send	VddSD2	○	○	○
SDAT22	–	B	SD I/F Ch2 Data 2		○	(*)	○
RXD0	–	I	UART Ch0 receive Data		○	○	○
GPIO56	–	B	GPIO		○	○	○
EXTINT56	–	I	External Interrupt 5-bit6		○	○	○
RTS1	Neg	O	UART Ch1 request to send	VddSD2	○	○	○
SDAT23	–	B	SD I/F Ch2 Data 3		○	(*)	○
TXD0	–	O	UART Ch0 transmit Data		○	○	○
GPIO57	–	B	GPIO		○	○	○
EXTINT57	–	I	External Interrupt 5-bit7		○	○	○
TXD2	–	O	UART Ch2 transmit Data	VddQSPI	○	○	○
TIOCA10	–	B	MTM1 Ch0A - target signal of pulse-length-reader function - output of sentinel-inform-function - output of PWM output		○	○	○
GPIO0B	–	B	GPIO		○	○	○
EXTINT0B	–	I	External Interrupt 0-bit11		○	○	○
RXD2	–	I	UART Ch2 receive Data	VddQSPI	○	○	○
TIOCA11	–	B	MTM1 Ch1A - target signal of pulse-length-reader function - output of sentinel-inform-function - output of PWM output		○	○	○
GPIO0C	–	B	GPIO		○	○	○
EXTINT0C	–	I	External Interrupt 0-bit12		○	○	○
Sum					6	6	6

(*)This function is not available

LC823450

(G) Timer

Terminal name	Polarity	Direction	Function	IO POWER	Available(○)		
					TA	XA, XC	XB, XD
Multiplexed function							
TIOCA00	–	B	MTM0 Ch0A - target signal of pulse-length-reader function - output of sentinel-inform-function - output of PWM output	VddSD2	○	○	○
SDCLK2	–	O	SD I/F Ch2 Clock Output		○	(*)	○
PHI0	–	O	System Clock Output 0		○	○	○
GPIO09	–	B	GPIO		○	○	○
EXTINT09	–	I	External Interrupt 0-bit9		○	○	○
TIOCA01	–	B	MTM0 Ch1A - target signal of pulse-length-reader function - output of sentinel-inform-function - output of PWM output	VddSD2	○	○	○
SDCMD2	–	B	SD I/F Ch2 command line		○	(*)	○
PHI1	–	O	System Clock Output 1		○	○	○
GPIO0A	–	B	GPIO		○	○	○
EXTINT0A	–	I	External Interrupt 0-bit10		○	○	○
TIOCB00	–	B	MTM0 Ch0B - target signal of pulse-length-reader function - output of sentinel-inform-function	Vdd2	○	○	○
DIN1	–	I	PCM1 Data Input		○	○	○
DMDIN0	–	I	Digital Mic Data Ch0 Input		○	○	○
GPIO02	–	B	GPIO		○	○	○
EXTINT02	–	I	External Interrupt 0-bit2		○	○	○
TIOCB01	–	B	MTM0 Ch1B - target signal of pulse-length-reader function - output of sentinel-inform-function	VddQSPI	○	○	○
DMCKO0	–	O	Digital Mic Clock Ch0 Output		○	○	○
QSCS	Neg	O	Serial I/FCh1 QSPI chip select * While Serial Flash Boot, this is used as chip select of Serial Flash		○	○	○
GPIO03	–	B	GPIO		○	○	○
EXTINT03	–	I	External Interrupt 0-bit3		○	○	○
TCLKA0	–	I	MTM0 external Clock A	Vdd2	○	○	○
BCK1	–	B	PCM1 bit Clock		○	○	○
GPIO00	–	B	GPIO		○	○	○
EXTINT00	–	I	External Interrupt 0-bit0		○	○	○
TCLKB0	–	I	MTM0 external Clock B		Vdd2	○	○
LRCK1	–	B	PCM1 LR Clock	○		○	○
GPIO01	–	B	GPIO	○		○	○
EXTINT01	–	I	External Interrupt 0-bit1	○		○	○
Sum					6	6	6

(*)This function is not available

LC823450

(H) PCM I/F

Terminal name Multiplexed function	Polarity	Direction	Function	IO POWER	Available(○)		
					TA	XA, XC	XB, XD
MCLK0	Pos	B	PCM0 maser Clock	Vdd2	○	○	○
MCLK1	Pos	B	PCM1 master Clock		○	○	○
GPIO18	–	B	GPIO		○	○	○
EXTINT18	–	I	External Interrupt 1-bit8		○	○	○
BCK0	–	B	PCM0 bit Clock	Vdd2	○	○	○
DMCKO1	–	O	Digital Mic Ch1 Clock Output		○	○	○
GPIO19	–	B	GPIO		○	○	○
EXTINT19	–	I	External Interrupt 1-bit9		○	○	○
LRCK0	–	B	PCM0 LR Clock	Vdd2	○	○	○
DMDIN1	–	I	Digital Mic Ch1 Data Input		○	○	○
GPIO1A	–	B	GPIO		○	○	○
EXTINT1A	–	I	External Interrupt 1-bit10		○	○	○
DIN0	–	I	PCM0 Data Input	Vdd2	○	○	○
DMDIN0	–	I	Digital Mic Ch0 Data Input		○	○	○
GPIO1B	–	B	GPIO		○	○	○
EXTINT1B	–	I	External Interrupt 1-bit11		○	○	○
DOUT0	–	O	PCM0 Data Output	Vdd2	○	○	○
DMCKO0	–	O	Digital Mic Ch0 Clock Output		○	○	○
GPIO1C	–	B	GPIO		○	○	○
EXTINT1C	–	I	External Interrupt 1-bit12		○	○	○
BCK1	–	B	PCM1 bit Clock	Vdd2		○	○
GPIO13	–	B	GPIO			○	○
EXTINT13	–	I	External Interrupt 1-bit3			○	○
LRCK1	–	B	PCM1 LR Clock	Vdd2		○	○
GPIO14	–	B	GPIO			○	○
EXTINT14	–	I	External Interrupt 1-bit4			○	○
DOUT1	–	O	PCM1 Data Output	Vdd2	○	○	○
GPIO15	–	B	GPIO		○	○	○
EXTINT15	–	I	External Interrupt 1-bit5		○	○	○
Sum					6	8	8

LC823450

(I) SD I/F/MS I/F

Terminal name	Polarity	Direction	Function	IO POWER	Available(○)		
					TA	XA, XC	XB, XD
Multiplexed function							
SDCLK0	–	O	SD I/F Ch0 Clock Output	VddSD0	○	○	○
SDCMD0	–	B	SD I/F Ch0 command line	VddSD0	○	○	○
SDAT0[3:0]	–	B	SD I/F Ch0 Data	VddSD0	○	○	○
SDCLK1	–	O	SD I/F Ch1 Clock Output	VddSD1	○	○	○
SCLK	–	O	Memory Stick Clock Output		○	○	○
GPIO22	–	B	GPIO		○	○	○
EXTINT22	–	I	External Interrupt 2-bit2		○	○	○
SDCMD1	–	B	SD I/F Ch1 command line	VddSD1	○	○	○
BS	–	O	Memory Stick BS		○	○	○
GPIO23	–	B	GPIO		○	○	○
EXTINT23	–	I	External Interrupt 2-bit3		○	○	○
SDAT1[3:0]	–	B	SD I/F Ch1 Data	VddSD1	○	○	○
DATA[3:0]	–	B	Memory Stick Data		○	○	○
GPIO2[7:4]	–	B	GPIO		○	○	○
EXTINT2[7:4]	–	I	External Interrupt 2-bit7 to bit4		○	○	○
Sum					12	12	12

(*)This function is not available

(J) SDRAM I/F

Terminal name	Polarity	Direction	Function	IO POWER	Available(○)		
					TA	XA, XC	XB, XD
Multiplexed function							
SDRCLK	Neg	O	SDRAM Clock Output	Vdd2			
SDRCKE	Pos	O	SDRAM Clock enable Output	Vdd2			
SDRCSS	Neg	O	SDRAM chip select Output	Vdd2			
SDRWE	Neg	O	SDRAM write enable Output	Vdd2			
SDRCAS	Neg	O	SDRAM CAS Output	Vdd2			
SDRRAS	Neg	O	SDRAM RAS Output	Vdd2			
SDRDQM[1:0]	Pos	O	SDRAM Data mask byte lane select	Vdd2			
SDRADDR[10:0]	–	O	SDRAM address(*)	Vdd2			
SDRBA[1:0]	–	O	SDRAM bank select	Vdd2			
SDRDATA[15:0]	–	B	SDRAM Data	Vdd2			
Sum					0	0	0

(*) SDRAM address bit is 13bit including SDRADDR [12:11].

LC823450

(K) External Memory I/F

Terminal name	Polarity	Direction	Function	IO POWER	Available(○)		
					TA	XA, XC	XB, XD
Multiplexed function							
NCS0	Neg	O	chip select0	Vdd2		○	○
GPIO06	–	B	GPIO			○	○
EXTINT06	–	I	External Interrupt 0-bit6			○	○
NCS1	Neg	O	chip select1	Vdd2		○	○
RXD0	–	I	UART Ch0 receive Data			○	○
GPIO10	–	B	GPIO			○	○
EXTINT10	–	I	External Interrupt 1-bit0			○	○
NRD	Neg	O	read enable	Vdd2		○	○
GPIO17	–	B	GPIO			○	○
EXTINT17	–	I	External Interrupt 1-bit7			○	○
NWRENWRL	Neg	O	write enable, write enable low	Vdd2		○	○
GPIO30	–	B	GPIO			○	○
EXTINT30	–	I	External Interrupt 3-bit0			○	○
NHBNWRH	Neg	O	high byte select, write enable high	Vdd2		○	○
TXD0	–	O	UART Ch0 transmit Data			○	○
GPIO31	–	B	GPIO			○	○
EXTINT31	–	I	External Interrupt 3-bit1			○	○
NLBEXA0	–	O	low byte select, address0	Vdd2		○	○
GPIO16	–	B	GPIO			○	○
EXTINT16	–	I	External Interrupt 1-bit6			○	○
EXA[20:15]	–	O	address	Vdd2			
GPIO4[5:0]	–	B	GPIO				
EXTINT4[5:0]	–	I	External Interrupt 4-bit5 to bit0				
EXA[14:9]	–	O	address	Vdd2			
GPIO3[F:A]	–	B	GPIO				
EXTINT3[F:A]	–	I	External Interrupt 3-bit15 to bit10				
EXA[8:1]	–	O	address	Vdd2			
GPIO3[9:2]	–	B	GPIO				
EXTINT3[9:2]	–	I	External Interrupt 3-bit9 to bit2				
EXD[7:0]	–	B	Data	Vdd2		○	○
GPIO4[D:6]	–	B	GPIO			○	○
EXTINT4[D:6]	–	I	External Interrupt 4-bit13 to bit6			○	○
EXD[15:8]	–	B	Data	Vdd2			
GPIO5[5:0], GPIO4[F:E]	–	B	GPIO				
EXTINT5[5:0], EXTINT4[F:E]	–	I	External Interrupt 5-bit5 to bit0, External Interrupt 4-bit15 to bit14				
Sum					0	14	14

LC823450

(L) Xtal, PLL

Terminal name	Polarity	Direction	Function	IO POWER	Available(○)		
					TA	XA, XC	XB, XD
Multiplexed function							
XIN1	–	I	XTAL input (XT1)	VddXT1	○	○	○
XOUT1	–	O	XTAL output (XT1)	VddXT1	○	○	○
VddXT1	–	P	XTAL power supply (XT1)	–	○	○	○
VssXT1	–	P	XTAL ground (XT1)	–	○	○	○
XTALINFO[1:0]	–	B	XTAL frequency input (*1) XTALINFO[1:0] = · “00” : 24MHz · “01” : 12MHz · “10” : 20MHz · “11” : 48MHz Used for determining clock frequency setting while internal ROM boot. Bonding internally for “TA” product	Vdd2		○	○
VCNT1	–	O	PLL1 VCO control	AVddPLL1	○	○	○
AVddPLL1	–	P	PLL1 analog power supply	–	○	○	○
AVssPLL1	–	P	PLL1 analog ground	–	○	○	○
VCNT2	–	O	PLL2 VCO control	AVddPLL2	○ (*2)	○	○
AVddPLL2	–	P	PLL2 analog power supply	–	○ (*2)	○	○
VCNT3	–	O	PLL3 VCO control	AVddPLL3	○ (*3)	○	○
AVddPLL3	–	P	PLL3 analog power supply	–	○ (*3)	○	○
AVssPLL2	–	P	PLL2/3 analog ground(*4)	–	○	○	○
Sum					10	14	14

(*1) Set according to the frequency of XT1(12/20/24/48MHz).

Bonding internally for “TA” product as described on Page 5.

(*2),(*)3 Audio clock is generated by one of PLL2(1V) or PLL3(3V).

One of PLL2 or PLL3 is available for “TA” and “RA” product. Please refer to Page 5 for more information.

Both of PLL2 and PLL3 are available for “XA”, “XB”, “XC” and “XD” products.

(*4) Analog ground is shared by PLL2 and PLL3.

LC823450

(M) USB-PHY

Terminal name	Polarity	Direction	Function	IO POWER	Available(○)		
					TA	XA, XC	XB, XD
Multiplexed function							
USBDP	–	B	USB D+	AVddUSBPHY2 or AVddUSBPHY1	○	○	○
USBDM	–	B	USB D–	AVddUSBPHY2 or AVddUSBPHY1	○	○	○
USBEXT12	–	O	USB-PHY reference resister	AVddUSBPHY2	○	○	○
AVddUSBPHY1	–	P	USB-PHY 1.0V analog power supply	–	○ 2	○ 2	○ 2
DVddUSBPHY1	–	P	USB-PHY 1.0V digital power supply. Connected to AVddUSBPHY1 internally in case of no DVddUSBPHY1 port available	–			
AVddUSBPHY2	–	P	USB-PHY 3.3V analog power supply	–	○ 2	○ 2	○ 2
AVssUSBPHY	–	P	USB-PHY analog ground	–	○ 4	○ 4	○ 4
Sum					11	11	11

(N) 10bit ADC

Terminal name	Polarity	Direction	Function	IO POWER	Available(○)		
					TA	XA, XC	XB, XD
Multiplexed function							
AN[5:0]	–	I	ADC Input	AVddADC	○	○	○
VRH	–	I	ADC High reference	AVddADC			
VRL	–	I	ADC Low reference	AVddADC			
VR	–	O	ADC reference voltage	AVddADC			
AVddADC	–	P	ADC analog power	–	○	○	○
AVssADC	–	P	ADC analog ground	–	○	○	○
Sum					8	8	8

LC823450

(O) Class-D AMP

Terminal name	Polarity	Direction	Function	IO POWER	Available(○)		
					TA	XA, XC	XB, XD
Multiplexed function							
LOUT	–	O	Lch Class D AMP Output	AVddDA	○		○
GPLOUT	–	O	General purpose Output (GPO)	MPL	○	○	○
ROUT	–	O	Rch Class D AMP Output	AVddDA	○		○
GPROUT	–	O	General purpose Output (GPO)	MPR	○	○	○
AVddDAMPL	–	P	Lch Class D AMP analog power supply	–	○	○	○
AVddDAMPR	–	P	Rch Class D AMP analog power supply	–	○	○	○
AVssDAMPL	–	P	Lch Class D AMP analog ground	–	○	○	○
AVssDAMPR	–	P	Rch Class D AMP analog ground	–	○	○	○
Sum					6	6	6

(P) Other, Power

Terminal name	Polarity	Direction	Function	IO POWER	Available(○)		
					TA	XA, XC	XB, XD
Multiplexed function							
BMODE[1:0]	–	B	Boot mode select	Vdd2	○	○	○
TEST	Pos	I	test mode(normally connect to ground)	Vdd2	○	○	○
NRES	Neg	I	LSI reset Input	Vdd2	○	○	○
Vdd1	–	P	Digital core power	–	○ 7	○ 7	○ 7
Vdd2	–	P	Digital IO power	–	○ 8	○ 8	○ 8
VddSD0	–	P	Digital IO power(SDI/F Ch0)	–	○	○	○
VddSD1	–	P	Digital IO power (SD(MS)I/F Ch1)	–	○	○	○
VddSD2	–	P	Digital IO power (SDI/F Ch2)	–	○	○	○
VddQSPI	–	P	Digital IO power (QSPI)	–	○	○	○
Vss	–	P	Digital ground	–	○ 12	○ 14	○14
Sum					35	37	37

All sum					128	154	154
---------	--	--	--	--	-----	-----	-----

Note : Unused Input terminals and input state terminals of bidirectional should be set Pull-up/Down resistor ON or connect to digital power supply or ground (don't left open).

LC823450

2-1 Boot mode

Boot modes available depend on BMODE[1:0] port status

IPL mode	BMODE1	BMODE0	explanation
Physical Boot USB	PD 470kΩ	PD 470kΩ	Internal ROM boot(eMMC Physical Boot with USB download –SD card I/F Ch0 + USB Device + EXTINT2E + EXTINT2F)
			By using Boot operation mode of eMMC, load IPL2(program) from eMMC connected to SD0 to internal SRAM and jump to IPL2. IPL2 is written through USB.
Physical Boot SD	PD 470kΩ	PU 470kΩ	Internal ROM boot(eMMC Physical Boot with SD Ch1 download –SD card I/F Ch0 + SD card I/F Ch1 + EXTINT2E + EXTINT2F)
			By using Boot operation mode of eMMC, load IPL2(program) from eMMC connected to SD0 to internal SRAM and jump to IPL2. IPL2 is written through SD1.
User Area Boot USB	PD 1kΩ	PU or PD 470kΩ	Internal ROM boot(User Area Boot with USB download –SD card I/F Ch0 + USB Device + EXTINT2E + EXTINT2F)
			Load IPL2(program) from user area of eMMC connected to SD0 to internal SRAM and jump to IPL2. IPL2 is written through USB.
User Area Boot SD	PU 470kΩ	PD 1kΩ	Internal ROM boot(User Area Boot with SD Ch1 download –SD card I/F Ch0 + SD card I/F Ch1 + EXTINT2E + EXTINT2F)
			Load IPL2(program) from user area of eMMC connected to SD0 to internal SRAM and jump to IPL2. IPL2 is written through SD1.
SPI Boot USB	PU 470kΩ	PU 470kΩ	Internal ROM boot(external Serial Flash SPI Boot with USB download –S-Flash I/F + USB Device + EXTINT2E + EXTINT2F + TIOCB01)
			Load IPL2(program) from Serial Flash connected to S-Flash I/F to internal SRAM and jump to IPL2. IPL2 is written through USB.
SPI Boot SD	PD 470kΩ	PU 1kΩ	Internal ROM boot(external Serial Flash SPI Boot with SD Ch1 download –S-Flash I/F + SD card I/F Ch1 + EXTINT2E + EXTINT2F + TIOCB01)
			Load IPL2(program) from Serial Flash connected to S-Flash I/F to internal SRAM and jump to IPL2. IPL2 is written through SD1.
QSPI Boot USB	PU 1kΩ	PU 470kΩ	Internal ROM boot(external Serial Flash QSPI Boot with USB download –S-Flash I/F(QSPI) + USB Device + EXTINT2E + EXTINT2F + TIOCB01)
			Fetch IPL2(program) from Serial Flash connected to S-Flash I/F. IPL2 is written by using DO command directly through USB.
QSPI Boot SD	PU 1kΩ	PD 470kΩ	Internal ROM boot(external Serial Flash QSPI Boot with SD Ch1 download –S-Flash I/F(QSPI) + SD card I/F Ch1 + EXTINT2E + EXTINT2F + TIOCB01)
			Fetch IPL2(program) from Serial Flash connected to S-Flash I/F. IPL2 is written through SD1.
User Area Delete	PD 1kΩ	PU 1kΩ	Internal ROM boot(User Area IPL2 delete –SD card I/F Ch0 + EXTINT2E + EXTINT2F)

LC823450

			After deleting IPL2 by using this mode, IPL2 can be written again while User Area Boot mode.
Partition Delete	PD 470kΩ	PD 1kΩ	Internal ROM boot(Partition Area IPL2 delete –SD card I/F Ch0 + EXTINT2E + EXTINT2F)
			After deleting IPL2 by using this mode, IPL2 can be written again while eMMC Physical Boot mode.
SPI All Erase	PU 470kΩ	PU 1kΩ	Internal ROM boot(external Serial Flash SPI all area delete –S-Flash I/F + EXTINT2E + EXTINT2F + TIOCB01)
			Delete all content of Serial Flash. This mode should be used in case of SPI mode operation of Serial Flash
SDCH0 All Erase	PD 1kΩ	PD 1kΩ	Internal ROM boot(all area delete –SD card I/F Ch0 + EXTINT2E + EXTINT2F)
			Delete all content of eMMC including Partition area. Take a lot of time to delete. Trim also processed in case of eMMC supporting Trim function.
QSPI All Erase	PU 1kΩ	PD 1kΩ	Internal ROM boot(external Serial Flash QSPI all area delete –S-Flash I/F(QSPI) + EXTINT2E + EXTINT2F + TIOCB01)
			Delete all content of Serial Flash. This mode should be used in case of QSPI fetch mode operation of Serial Flash
External ROM Boot	PU 470kΩ	PD 470kΩ	External memory boot(External-0)
			Fetch from external memory(External0) connected to XMC(external memory controller)
Hi-z	PU 1kΩ	PU 1kΩ	External I/F ports below forced to Hiz - EXA[20:1],EXD[15:0],NCS[1:0],NRD,NWRENWRL,NHBNWRH,NLBEXA0 - SDCLK0,SDCMD0,SDAT0[3:0] - CK1,SDI1(QIO0),SDO1(QIO1),SWP1(QIO2),SHOLD1(QIO3),TIOCB01

· In case of TQFP128L, WLP154, don't use external memory boot (External-0)

LC823450

2-2 Boot port

Some ports are used in internal ROM code while booting as below.

- EXTINT2E(GPIO2E) : OUT for power supply control
- EXTINT2F(GPIO2F) : OUT for indicating status of boot, start of USB connection and USB disconnection, error status by Low/High of this port.
- Use SDCMD1, SDAT1[3:0], SDCLK1 as SD1. SDCD1 and SDWP1 are not used.
Port function switch is processed during write from SD1.
- SPI Boot/SPI All Erase is processed by using 4 ports SCK1, QSCS, SDO1,SDI1.
SHOLD1 and SWP1 are not used.
- QSPI Boot/QSPI All Erase is processed by using SCK1, QSCS, SDO1, SDI1, SHOLD1, SWP1.
- External ROM Boot is processed by using NCS0 and external memory controller ports.
GPIO2E is not used.
- In case of External I/F ports Hiz mode, external memory interface ports such as NCS0, NCS1 and external memory controller ports is used. GPIO2E is used as input port.

Ports used during IPL	
IPL mode	Ports used(*)
Physical Boot USB	P2E(power supply control), P2F(status monitoring)
Physical Boot SD	P2E(power supply control), P2F(status monitoring) P22(SDCLK1) P23(SDCMD1) P24(SDDATA10) P25(SDDATA11) P26(SDDATA12) P27(SDDATA13)
User Area Boot USB	P2E(power supply control), P2F(status monitoring)
User Area Boot SD	P2E(power supply control), P2F(status monitoring) P22(SDCLK1) P23(SDCMD1) P24(SDDATA10) P25(SDDATA11) P26(SDDATA12) P27(SDDATA13)
SPI Boot USB	P2E(power supply control), P2F(status monitoring) P0D(SCK1) P03(QSCS) P0F(SDO1) P0E(SDI1)
SPI Boot SD	P2E(power supply control), P2F(status monitoring) P0D(SCK1) P03(QSCS) P0F(SDO1) P0E(SDI1) P22(SDCLK1) P23(SDCMD1) P24(SDDATA10) P25(SDDATA11) P26(SDDATA12) P27(SDDATA13)
QSPI Boot USB	P2E(power supply control), P2F(status monitoring) P0D(SCK1) P03(QSCS) P0F(SDO1) P0E(SDI1) P11(SWP1) P12(SHOLD1)
QSPI Boot SD	P2E(power supply control), P2F(status monitoring) P0D(SCK1) P03(QSCS) P0F(SDO1) P0E(SDI1) P011(SWP1) P12(SHOLD1) P22(SDCLK1) P23(SDCMD1) P24(SDDATA10) P25(SDDATA11) P26(SDDATA12) P27(SDDATA13)
User Area Delete	P2E(power supply control), P2F(status monitoring)
Partition Delete	P2E(power supply control), P2F(status monitoring)
SPI Erase	P2E(power supply control), P2F(status monitoring) P0D(SCK1) P03(QSCS) P0F(SPIOUT) P0E(SDI1)
SDCH0 All Erase	P2E(power supply control), P2F(status monitoring)
QSPI All Erase	P2E(power supply control), P2F(status monitoring) P0D(SCK1) P03(QSCS) P0F(SDO1) P0E(SDI1) P11(SWP1) P12(SHOLD1)
External ROM Boot	P06(NCS0) P17(NRD) P30(NWRENWRL) P31(NHBNWRH) P16(NLBEXA0) P32(EXA01) P33(EXA02) P34(EXA03) P35(EXA06) P36(EXA05) P37(EXA06) P38(EXA07) P39(EXA08) P3A(EXA09) P3B(EXA10) P3C(EXA11) P3D(EXA12) P3E(EXA13) P3F(EXA14) P40(EXA15) P41(EXA16) P42(EXA17) P43(EXA18) P44(EXA19) P45(EXA20) P46(EXD00) P47(EXD01) P48(EXD02) P49(EXD03) P4A(EXD04) P4B(EXD05) P4C(EXD06) P4D(EXD07) P4E(EXD08) P4F(EXD09) P50(EXD10) P51(EXD11) P52(EXD12) P53(EXD13) P54(EXD14) P55(EXD15)
HI-z	SDCLK0 Hi-z state

(*) In this table, "Pxx" means "GPIOxx". For example "P2E" means "GPIO2E".

2-3 SDIF PullUp

In case of boot mode using SDIF port, internal PullUp resistor is used (SDCMD0, SDAT0[3:0] / SDCMD1, SDAT1[3:0]). So, external PullUp resistor is not required on board.

2-4 QSCS PullUp

In case of boot mode using QSCS, PullUp of GPIO03(QSCS) is active by the hard reset. After GPIO2E is set to high, GPIO03 set to QSCS and PullUp set to inactive.
In case of Hi-z boot, PullUp is forced to inactive

2-5 GPIO2F

During boot, GPIO2F is used as GPIO and indicates boot status and error occurrence by output of Low/High. When errors occur during boot sequences, for example writing of IPL2, GPIO2F reports the sort of error. GPIO0F can indicate the status of USB connection and the completion of USB file transfer. And Delete Mode, completion of Erase, and status of Erase can be reported by sequence of Low/High.

For more detail about the behavior of ports used during boot, refer to the document LC823450 Series IPL specification.

LC823450

3 Pin Assignment 3-1 Pin Assignment

I/O		Input Type		Output Type	
I	Input	CMOS	CMOS Input	3-State	Tristate Output
O	Output	schmitt	schmitt Input	OD	open drain Output
B	Bidirectional	X	Xtal	X	Xtal
P	power	3A	3.3V analog	3A	3.3V analog
NC	Non Connect	1A	1.0V analog	1A	1.0/1.2V analog

Drive (example)		PU/PD		IO Circuit Type	
4mA	3.3V 4mA Output	PU	pull-up resistor	Refer to Page 34 for circuit diagram	
4/8mA	3.3V with 4mA, 8mA output drivability switch	PD	pull-down resistor		
0.3mA-OD	1.0V 0.3mA open drain Output	PU/PD	pull-up, pull-down resistor		

XBGA240		TQFP128L		WLP154		PIN NAME	I/O	Input Type	Output Type	Drive	PU/PD	IO Pwr Grp	IO Circuit Type
No.	Ball	No.	No.	Ball									
1	R16	-	-		SDRDATA2	B	CMOS	3-State	2/4/8mA	PD	Vdd2	3ICD/3T2(4)(8)	
2	N14	1	1	M11	Vss	G							
3	P15	2	2	N12	Vdd2	P							
4	P16	3	3	H8	TCLKA0/ BCK1/ GPIO00/ EXTINT00	I/ B/ B/ I	schmitt	3-State	1/2/4mA	PU/PD	Vdd2	3ISUD/3T1(2)(4)	
5	N15	-	-		SDRDATA3	B	CMOS	3-State	2/4/8mA	PD	Vdd2	3ICD/3T2(4)(8)	
6	N16	4	4	L10	TCLKB0/ LRCK1/ GPIO01/ EXTINT01	I/ B/ B/ I	schmitt	3-State	1/2/4mA	PU/PD	Vdd2	3ISUD/3T1(2)(4)	
7	M16	-	5	K9	NHBNWRH/ TXD0/ GPIO31/ EXTINT31	O/ O/ B/ I	schmitt	3-State	2/4/8mA	PD	Vdd2	3ISD/3T2(4)(8)	
8	M15	-	6	N11	NCS1/ RXD0/ GPIO10/ EXTINT10	O/ I/ B/ I	schmitt	3-State	2/4/8mA	PU	Vdd2	3ISU/3T2(4)(8)	
9	M14	-	-		SDRDATA4	B	CMOS	3-State	2/4/8mA	PD	Vdd2	3ICD/3T2(4)(8)	
10	M13	-	7	M10	NCS0/ GPIO06/ EXTINT06	O/ B/ I	schmitt	3-State	2/4/8mA	PU	Vdd2	3ISU/3T2(4)(8)	
11	L16	-	-		GPIO2A/ EXTINT2A/ SDRADDR12	B/ I/ O	schmitt	3-State	2/4/8mA	PU/PD	Vdd2	3ISUD/3T2(4)(8)	
12	L15	-	-		Vdd2	P							
13	L14	-	-		Vss	G							
14	L13	5	8	L9	Vdd1	P							
15	L12	-	9	N10	NRD/ GPIO17/ EXTINT17	O/ B/ I	schmitt	3-State	2/4/8mA	PD	Vdd2	3ISD/3T2(4)(8)	
16	K16	-	-		SDRADDR5	O	-	3-State	2/4/8mA		Vdd2	3T2(4)(8)	
17	K15	-	-		SDRADDR6	O	-	3-State	2/4/8mA		Vdd2	3T2(4)(8)	
18	K14	-	10	M9	NWRENWRL/ GPIO30/ EXTINT30	O/ B/ I	schmitt	3-State	2/4/8mA	PD	Vdd2	3ISD/3T2(4)(8)	

LC823450

19	K13	-	11	N9	EXD0/ GPIO46/ EXTINT46	B/ B/ I	schmitt	3-State	2/4/8mA	PD	Vdd2	3ISD/3T2(4)(8)
20	K12	-	-		SDRADDR7	O	-	3-State	2/4/8mA		Vdd2	3T2(4)(8)
21	H13	-	-		SDRDATA5	B	CMOS	3-State	2/4/8mA	PD	Vdd2	3ICD/3T2(4)(8)
22	J14	-	-		SDRDATA6	B	CMOS	3-State	2/4/8mA	PD	Vdd2	3ICD/3T2(4)(8)
23	J13	-	-		Vdd2	P						
24	H10	-	-		Vss	G						
25	J12	-	-		SDRDATA7	B	CMOS	3-State	2/4/8mA	PD	Vdd2	3ICD/3T2(4)(8)
26	J11	-	-		SDRDATA8	B	CMOS	3-State	2/4/8mA	PD	Vdd2	3ICD/3T2(4)(8)
27	H11	-	-		SDRDATA9	B	CMOS	3-State	2/4/8mA	PD	Vdd2	3ICD/3T2(4)(8)
28	H16	6	12	J8	SCK1/ GPIO0D/ EXTINT0D	O/ B/ I	schmitt	3-State	6/8/10mA	PU/PD	VddQSPI	3ISUD/3T6(8)(10)
29	H14	7	13	N8	TIOCB01/ DMCKO0/ QSCS/ GPIO03/ EXTINT03	B/ O/ O/ B/ I	schmitt	3-State	6/8/10mA	PU/PD	VddQSPI	3ISUD/3T6(8)(10)
30	J16	8	14	M8	SDO1(QIO1)/ GPIO0F/ EXTINT0F	I(B)/ B/ I	schmitt	3-State	6/8/10mA	PU/PD	VddQSPI	3ISUD/3T6(8)(10)
31	G14	9	15	L8	VddQSPI	P						
32	H15	10	16	K8	SDI1(QIO0)/ GPIO0E/ EXTINT0E	O(B)/ B/ I	schmitt	3-State	6/8/10mA	PU/PD	VddQSPI	3ISUD/3T6(8)(10)
33	J15	11	17	N7	Vss	G						
34	G16	12	18	M7	SWP1(QIO2)/ GPIO11/ EXTINT11	O(B)/ B/ I	schmitt	3-State	6/8/10mA	PU/PD	VddQSPI	3ISUD/3T6(8)(10)
35	G15	13	19	L7	SHOLD1(QIO3)/ GPIO12/ EXTINT12	O(B)/ B/ I	schmitt	3-State	6/8/10mA	PU/PD	VddQSPI	3ISUD/3T6(8)(10)
36	H12	14	20	K7	TXD2/ TIOCA10/ GPIO0B/ EXTINT0B	O/ B/ B/ I	schmitt	3-State	1/2/4mA	PU/PD	VddQSPI	3ISUD/3T1(2)(4)
37	G13	15	21	J7	RXD2/ TIOCA11/ GPIO0C/ EXTINT0C	I/ B/ B/ I	schmitt	3-State	1/2/4mA	PU/PD	VddQSPI	3ISUD/3T1(2)(4)
38	G12	16	22	N6	TDI/ SDCD1/ SWO/ GPIO20/ EXTINT20	I/ I/ O/ B/ I	schmitt	3-State	2mA	PU/PD	VddSD1	3ISUD/3T2
39	G11	17	23	M6	TDO/ SDWP1/ INS/ GPIO21/ EXTINT21	O/ I/ I/ B/ I	schmitt	3-State	2mA	PU/PD	VddSD1	3ISUD/3T2
40	F16	18	24	L6	SDCMD1/ BS/ GPIO23/ EXTINT23	B/ O/ B/ I	CMOS	3-State	6/8/10mA	PU/PD	VddSD1	3ICUD/3T6(8)(10)
41	F15	19	25	K6	SDAT10/ DATA0/ GPIO24/ EXTINT24	B/ B/ B/ I	CMOS	3-State	6/8/10mA	PU/PD	VddSD1	3ICUD/3T6(8)(10)
42	F14	20	26	N5	VddSD1	P						

LC823450

43	E14	21	27	M5	SDAT11/ DATA1/ GPIO25/ EXTINT25	B/ B/ B/ I	CMOS	3-State	6/8/10mA	PU/PD	VddSD1	3ICUD/3T6(8)(10)
44	F13	22	28	L5	Vss	G						
45	E16	23	29	J6	SDAT12/ DATA2/ GPIO26/ EXTINT26	B/ B/ B/ I	CMOS	3-State	6/8/10mA	PU/PD	VddSD1	3ICUD/3T6(8)(10)
46	E15	24	30	N4	SDAT13/ DATA3/ GPIO27/ EXTINT27	B/ B/ B/ I	CMOS	3-State	6/8/10mA	PU/PD	VddSD1	3ICUD/3T6(8)(10)
47	D16	25	31	M4	SDCLK1/ SCLK/ GPIO22/ EXTINT22	O/ O/ B/ I	CMOS	3-State	6/8/10mA	PU/PD	VddSD1	3ICUD/3T6(8)(10)
48	F12	-	-		SDRADDR8	O	-	3-State	2/4/8mA		Vdd2	3T2(4)(8)
49	E12	-	-		SDRADDR9	O	-	3-State	2/4/8mA		Vdd2	3T2(4)(8)
50	F11	-	-		SDRADDR10	O	-	3-State	2/4/8mA		Vdd2	3T2(4)(8)
51	E13	26	32	L4	Vdd1	P						
52	D13	27	33	N3	Vss	G						
53	D14	28	34	N2	Vdd2	P						
54	D15	-	-		SDRBA0	O	-	3-State	2/4/8mA		Vdd2	3T2(4)(8)
55	C16	-	-		SDRBA1	O	-	3-State	2/4/8mA		Vdd2	3T2(4)(8)
56	C15	-	-		SDRCAS	O	-	3-State	2/4/8mA		Vdd2	3T2(4)(8)
57	C14	-	-		SDRRAS	O	-	3-State	2/4/8mA		Vdd2	3T2(4)(8)
58	B16	-	-		Vdd2	P						
59	B15	-	-		Vss	G						
60	A16	-	-		SDRCKE	O	-	3-State	2/4/8mA		Vdd2	3T2(4)(8)
61	A15	-	-		SDRCLK	O	-	3-State	2/4/8mA		Vdd2	3T2(4)(8)
62	A14	29	35	M3	SDCLK0	O	CMOS	3-State	6/8/10mA		VddSD0	3IC/3T6(8)(10)
63	B14	30	36	K5	SDCMD0	B	CMOS	3-State	6/8/10mA	PU/PD	VddSD0	3ICUD/3T6(8)(10)
64	C12	31	37	N1	VddSD0	P						
65	B13	32	38	L3	SDAT00	B	CMOS	3-State	6/8/10mA	PU/PD	VddSD0	3ICUD/3T6(8)(10)
66	C13	33	39	M2	Vss	G						
67	A13	34	40	K4	SDAT01	B	CMOS	3-State	6/8/10mA	PU/PD	VddSD0	3ICUD/3T6(8)(10)
68	A12	35	41	M1	SDAT02	B	CMOS	3-State	6/8/10mA	PU/PD	VddSD0	3ICUD/3T6(8)(10)
69	B12	36	42	J5	SDAT03	B	CMOS	3-State	6/8/10mA	PU/PD	VddSD0	3ICUD/3T6(8)(10)
70	C11	37	43	K3	TIOCA01/ SDCMD2/ PHI1/ GPIO0A/ EXTINT0A	B/ B/ O/ B/ I	CMOS	3-State	6/8/10mA	PU/PD	VddSD2	3ICUD/3T6(8)(10)
71	A11	38	44	L2	TXD1/ SDAT20/ GPIO04/ EXTINT04	O/ B/ B/ I	CMOS	3-State	6/8/10mA	PU/PD	VddSD2	3ICUD/3T6(8)(10)
72	B11	39	45	J4	RXD1/ SDAT21/ GPIO05/ EXTINT05	I/ B/ B/ I	CMOS	3-State	6/8/10mA	PU/PD	VddSD2	3ICUD/3T6(8)(10)
73	D12	40	46	L1	VddSD2	P						
74	C10	41	47	H6	CTS1/ SDAT22/ RXD0/ GPIO56/ EXTINT56	I/ B/ I/ B/ I	CMOS	3-State	6/8/10mA	PU/PD	VddSD2	3ICUD/3T6(8)(10)
75	E11	42	48	K2	Vss	G						

LC823450

76	B10	43	49	K1	RTS1/ SDAT23/ TXD0/ GPIO57/ EXTINT57	O/ B/ O/ B/ I	CMOS	3-State	6/8/10mA	PU/PD	VddSD2	3ICUD/3T6(8)(10)
77	D11	44	50	J3	TCK/ SDCD2/ GPIO29/ EXTINT29	I/ I/ B/ I	schmitt	3-State	1/2/4mA	PU/PD	VddSD2	3ISUD/3T1(2)(4)
78	D10	45	51	H5	TMS/ SDWP2/ GPIO28/ EXTINT28	I/ I/ B/ I	schmitt	3-State	1/2/4mA	PU/PD	VddSD2	3ISUD/3T1(2)(4)
79	A10	46	52	J2	TIOCA00/ SDCLK2/ PHIO/ GPIO09/ EXTINT09	B/ O/ O/ B/ I	schmitt	3-State	6/8/10mA	PU/PD	VddSD2	3ISUD/3T6(8)(10)
80	E10	-	-		SDRCS	O	-	3-State	2/4/8mA		Vdd2	3T2(4)(8)
81	F10	-	-		SDRWE	O	-	3-State	2/4/8mA		Vdd2	3T2(4)(8)
82	G10	-	-		SDRDQM0	O	-	3-State	2/4/8mA		Vdd2	3T2(4)(8)
83	D9	-	-		SDRDQM1	O	-	3-State	2/4/8mA		Vdd2	3T2(4)(8)
84	E9	-	-		SDRDATA10	B	CMOS	3-State	2/4/8mA	PD	Vdd2	3ICD/3T2(4)(8)
85	F9	-	-		SDRDATA11	B	CMOS	3-State	2/4/8mA	PD	Vdd2	3ICD/3T2(4)(8)
86	A9	47	53	J1	Vdd1	P						
87	B9	48	54	H4	Vss	G						
88	G9	-	55	G5	XTALINFO0	B	schmitt	3-State	2/4/8mA	PU	Vdd2	3ISU/3T2(4)(8)
89	C9	49	56	H1	Vdd2	P						
90	H9	-	-		SDRDATA12	B	CMOS	3-State	2/4/8mA	PD	Vdd2	3ICD/3T2(4)(8)
91	G8	-	-		SDRDATA13	B	CMOS	3-State	2/4/8mA	PD	Vdd2	3ICD/3T2(4)(8)
92	F8	-	-		SDRDATA14	B	CMOS	3-State	2/4/8mA	PD	Vdd2	3ICD/3T2(4)(8)
93	E8	-	-		SDRDATA15	B	CMOS	3-State	2/4/8mA	PD	Vdd2	3ICD/3T2(4)(8)
94	D8	50	57	H2	VddRTC	P						
95	A7	-	58	H3	RTCMODE	I	CMOS	-	-	-	VddRTC	1IC
96	B8	51	59	G2	VssRTC	G						
97	A8	52	60	G1	XIN32K	I	X	-	-	-	VddRTC	X
98	C8	53	61	G3	XOUT32K	O	-	X	-	-	VddRTC	X
99	B7	54	62	F1	VDET	I	CMOS	-	-	-	VddRTC	1IC
100	C7	55	63	G4	RTCINT(*1)	O	-	OD	0.3mA-OD	-	VddRTC	OD3
101	D7	56	64	F2	BACKUPB	I	schmitt	-	-	-	VddRTC	1IS
102	E7	-	65	F3	KEYINT0	I	schmitt	-	-	PD	VddRTC	1ISD
103	F7	-	66	F4	KEYINT1	I	schmitt	-	-	PD	VddRTC	1ISD
104	G7	-	67	E1	KEYINT2	I	schmitt	-	-	PD	VddRTC	1ISD
105	A6	57	68	E2	AVddADC	P						
106	B6	-	-		VRH	I	3A	-	-	-	AVddADC	3A
107	C6	-	-		VR	O	-	3A	-	-	AVddADC	3A
108	D6	-	-		VRL	I	3A	-	-	-	AVddADC	3A
109	E6	58	69	D1	AVssADC	G						
110	C5	59	70	E3	AN5	I	3A	-	-	-	AVddADC	3A
111	B5	60	71	D2	AN4	I	3A	-	-	-	AVddADC	3A
112	A5	61	72	D3	AN3	I	3A	-	-	-	AVddADC	3A
113	C4	62	73	C1	AN2	I	3A	-	-	-	AVddADC	3A
114	B4	63	74	C2	AN1	I	3A	-	-	-	AVddADC	3A
115	A4	64	75	B1	AN0	I	3A	-	-	-	AVddADC	3A

LC823450

116	D5	-	76	F5	NLBEXA0/ GPIO16/ EXTINT16	O/ B/ I	schmitt	3-State	2/4/8mA	PD	Vdd2	3ISD/3T2(4)(8)
117	F6	-	77	E4	EXD1/ GPIO47/ EXTINT47	B/ B/ I	schmitt	3-State	2/4/8mA	PD	Vdd2	3ISD/3T2(4)(8)
118	A3	-	-		EXA1/ GPIO32/ EXTINT32	O/ B/ I	schmitt	3-State	2/4/8mA	PD	Vdd2	3ISD/3T2(4)(8)
119	B3	-	-		EXA2/ GPIO33/ EXTINT33	O/ B/ I	schmitt	3-State	2/4/8mA	PD	Vdd2	3ISD/3T2(4)(8)
120	A2	-	-		EXA3/ GPIO34/ EXTINT34	O/ B/ I	schmitt	3-State	2/4/8mA	PD	Vdd2	3ISD/3T2(4)(8)
121	A1	-	-		Vss	G						
122	B2	-	-		Vdd2	P						
123	B1	-	-		EXA4/ GPIO35/ EXTINT35	O/ B/ I	schmitt	3-State	2/4/8mA	PD	Vdd2	3ISD/3T2(4)(8)
124	C1	-	-		EXA5/ GPIO36/ EXTINT36	O/ B/ I	schmitt	3-State	2/4/8mA	PD	Vdd2	3ISD/3T2(4)(8)
125	C2	-	-		EXA6/ GPIO37/ EXTINT37	O/ B/ I	schmitt	3-State	2/4/8mA	PD	Vdd2	3ISD/3T2(4)(8)
126	C3	65	78	A1	SCL0/ GPIO07/ EXTINT07	O/ B/ I	schmitt	3-State	1/2/4mA	PU/PD	Vdd2	3ISUD/3T1(2)(4)
127	D3	-	-		EXA7/ GPIO38/ EXTINT38	O/ B/ I	schmitt	3-State	2/4/8mA	PD	Vdd2	3ISD/3T2(4)(8)
128	D4	66	79	B2	SDA0/ GPIO08/ EXTINT08	B/ B/ I	schmitt	3-State	1/2/4mA	PU/PD	Vdd2	3ISUD/3T1(2)(4)
129	E4	-	-		EXA8/ GPIO39/ EXTINT39	O/ B/ I	schmitt	3-State	2/4/8mA	PD	Vdd2	3ISD/3T2(4)(8)
130	E5	67	80	C3	SDO0/ GPIO1F/ EXTINT1F	O/ B/ I	schmitt	3-State	1/2/4mA	PU/PD	Vdd2	3ISUD/3T1(2)(4)
131	D1	68	81	D4	Vss	G						
132	D2	69	82	A2	Vdd2	P						
133	F4	-	-		EXA9/ GPIO3A/ EXTINT3A	O/ B/ I	schmitt	3-State	2/4/8mA	PD	Vdd2	3ISD/3T2(4)(8)
134	F5	-	-		EXA10/ GPIO3B/ EXTINT3B	O/ B/ I	schmitt	3-State	2/4/8mA	PD	Vdd2	3ISD/3T2(4)(8)
135	G5	-	-		EXA11/ GPIO3C/ EXTINT3C	O/ B/ I	schmitt	3-State	2/4/8mA	PD	Vdd2	3ISD/3T2(4)(8)
136	G4	70	83	B3	SCK0/ GPIO1D/ EXTINT1D	B/ B/ I	schmitt	3-State	1/2/4mA	PU/PD	Vdd2	3ISUD/3T1(2)(4)
137	G6	-	-		EXA12/ GPIO3D/ EXTINT3D	O/ B/ I	schmitt	3-State	2/4/8mA	PD	Vdd2	3ISD/3T2(4)(8)
138	H4	71	84	A3	SWDCLK/ GPIO58/ EXTINT58/ DMCKO1	I/ B/ I/ O	schmitt	3-State	1/2/4mA	PU/PD	Vdd2	3ISUD/3T1(2)(4)
139	H5	-	-		EXA13/ GPIO3E/ EXTINT3E	O/ B/ I	schmitt	3-State	2/4/8mA	PD	Vdd2	3ISD/3T2(4)(8)
140	H6	72	85	F6	SDI0/ GPIO1E/ EXTINT1E	I/ B/ I	schmitt	3-State	1/2/4mA	PU/PD	Vdd2	3ISUD/3T1(2)(4)

LC823450

141	J4	-	-		EXA14/ GPIO3F/ EXTINT3F	O/ B/ I	schmitt	3-State	2/4/8mA	PD	Vdd2	3ISD/3T2(4)(8)
142	J5	73	86	C4	SWDIO/ GPIO59/ EXTINT59/ DMDIN1	B/ B/ I/ I	schmitt	3-State	2mA	PU	Vdd2	3ISU/3T2
143	H7	-	87	E5	EXD2/ GPIO48/ EXTINT48	B/ B/ I	schmitt	3-State	2/4/8mA	PD	Vdd2	3ISD/3T2(4)(8)
144	J6	-	88	A4	EXD3/ GPIO49/ EXTINT49	B/ B/ I	schmitt	3-State	2/4/8mA	PD	Vdd2	3ISD/3T2(4)(8)
145	E3	74	89	B4	Vdd1	P						
146	F3	-	-		Vdd2	P						
147	G3	-	90	D5	Vss	G						
148	K6	-	-		EXA15/ GPIO40/ EXTINT40	O/ B/ I	schmitt	3-State	2/4/8mA	PD	Vdd2	3ISD/3T2(4)(8)
149	K5	-	-		EXA16/ GPIO41/ EXTINT41	O/ B/ I	schmitt	3-State	2/4/8mA	PD	Vdd2	3ISD/3T2(4)(8)
150	L5	-	-		EXA17/ GPIO42/ EXTINT42	O/ B/ I	schmitt	3-State	2/4/8mA	PD	Vdd2	3ISD/3T2(4)(8)
151	M4	-	-		EXA18/ GPIO43/ EXTINT43	O/ B/ I	schmitt	3-State	2/4/8mA	PD	Vdd2	3ISD/3T2(4)(8)
152	K4	-	-		Vss	G						
153	E2	-	-		DVddUSBPHY1	P						
154	F2	75	91	A5	AVddUSBPHY1	P						
155	G2	76	92	C5	AVssUSBPHY	G						
156	E1	77	93	B5	USBDM	B	3A	3A	-	-	AVddUSBPHY2	3A
157	F1	78	94	B6	USBDP	B	3A	3A	-	-	AVddUSBPHY2	3A
158	G1	79	95	C6	AVssUSBPHY	G						
159	H2	80	96	D6	AVddUSBPHY2	P						
160	J1	81	97	E6	AVssUSBPHY	G						
161	H1	82	98	B7	USBEXT12	O	-	3A	-	-	AVddUSBPHY2	3A
162	J2	83	99	C7	AVddUSBPHY2	P						
163	H3	84	100	D7	AVddUSBPHY1	P						
164	J3	85	101	E7	AVssUSBPHY	G						
165	K3	-	-		DVddUSBPHY1	P						
166	L1	-	-		Vss	G						
167	K2	86	102	B8	VddXT1	P						
168	K1	87	103	A8	XIN1	I	X	-	-	-	VddXT1	X
169	L2	88	104	D8	VssXT1	G						
170	L3	89	105	C8	XOUT1	O	-	X	-	-	VddXT1	X
171	L4	90	106	E8	Vdd1	P						
172	M3	-	-		Vss	G						
173	M2	91	107	A9	AVddPLL1	P						
174	M1	92	108	B9	VCNT1	O	-	1A	-	-	AVddPLL1	1A
175	N1	93	109	C9	AVssPLL1	G						
176	N3	-	110	A10	EXD4/ GPIO4A/ EXTINT4A	B/ B/ I	schmitt	3-State	2/4/8mA	PD	Vdd2	3ISD/3T2(4)(8)
177	N2	-	-		Vss	G						
178	P1	-	-		Vdd2	P						

LC823450

179	P2	-	111	B10	EXD5/ GPIO4B/ EXTINT4B	B/ B/ I	schmitt	3-State	2/4/8mA	PD	Vdd2	3ISD/3T2(4)(8)
180	R1	-	112	D9	EXD6/ GPIO4C/ EXTINT4C	B/ B/ I	schmitt	3-State	2/4/8mA	PD	Vdd2	3ISD/3T2(4)(8)
181	R2	-	-		EXA19/ GPIO44/ EXTINT44	O/ B/ I	schmitt	3-State	2/4/8mA	PD	Vdd2	3ISD/3T2(4)(8)
182	R3	-	-		EXA20/ GPIO45/ EXTINT45	O/ B/ I	schmitt	3-State	2/4/8mA	PD	Vdd2	3ISD/3T2(4)(8)
183	P3	-	113	A11	EXD7/ GPIO4D/ EXTINT4D	B/ B/ I	schmitt	3-State	2/4/8mA	PD	Vdd2	3ISD/3T2(4)(8)
184	N4	94	114	F7	TIOCB00/ DMDIN0/ DIN1/ GPIO02/ EXTINT02	B/ I/ B/ I	schmitt	3-State	1/2/4mA	PU/PD	Vdd2	3ISUD/3T1(2)(4)
185	R4	-	115	B11	Vss	G						
186	P4	95	116	A12	Vdd2	P						
187	M6	96	117	C10	DOU1/ GPIO15/ EXTINT15	O/ B/ I	schmitt	3-State	1/2/4mA	PU/PD	Vdd2	3ISUD/3T1(2)(4)
188	N5	-	-		EXD8/ GPIO4E/ EXTINT4E	B/ B/ I	schmitt	3-State	2/4/8mA	PD	Vdd2	3ISD/3T2(4)(8)
189	M5	-	-		EXD9/ GPIO4F/ EXTINT4F	B/ B/ I	schmitt	3-State	2/4/8mA	PD	Vdd2	3ISD/3T2(4)(8)
190	L6	-	118	G6	BCK1/ GPIO13/ EXTINT13	B/ B/ I	schmitt	3-State	1/2/4mA	PU/PD	Vdd2	3ISUD/3T1(2)(4)
191	M7	-	-		EXD10/ GPIO50/ EXTINT50	B/ B/ I	schmitt	3-State	2/4/8mA	PD	Vdd2	3ISD/3T2(4)(8)
192	N7	-	119	G7	LRCK1/ GPIO14/ EXTINT14	B/ B/ I	schmitt	3-State	1/2/4mA	PU/PD	Vdd2	3ISUD/3T1(2)(4)
193	N6	97	120	B12	MCLK0/ MCLK1/ GPIO18/ EXTINT18	B/ B/ B/ I	schmitt	3-State	1/2/4mA	PU/PD	Vdd2	3ISUD/3T1(2)(4)
194	L7	-	-		EXD11/ GPIO51/ EXTINT51	B/ B/ I	schmitt	3-State	2/4/8mA	PD	Vdd2	3ISD/3T2(4)(8)
195	M8	98	121	H7	BCK0/ DMCKO1/ GPIO19/ EXTINT19	B/ O/ B/ I	schmitt	3-State	1/2/4mA	PU/PD	Vdd2	3ISUD/3T1(2)(4)
196	K7	-	-		EXD12/ GPIO52/ EXTINT52	B/ B/ I	schmitt	3-State	2/4/8mA	PD	Vdd2	3ISD/3T2(4)(8)
197	P5	99	122	C11	Vdd2	P						
198	J7	-	123	D10	XTALINFO1	B	schmitt	3-State	2/4/8mA	PU	Vdd2	3ISU/3T2(4)(8)
199	P6	100	124	C12	Vss	G						
200	L8	-	-		EXD13/ GPIO53/ EXTINT53	B/ B/ I	schmitt	3-State	2/4/8mA	PD	Vdd2	3ISD/3T2(4)(8)
201	K8	101	125	E9	LRCK0/ DMDIN1/ GPIO1A/ EXTINT1A	B/ I/ B/ I	schmitt	3-State	1/2/4mA	PU/PD	Vdd2	3ISUD/3T1(2)(4)

LC823450

202	J8	-	-		EXD14/ GPIO54/ EXTINT54	B/ B/ I	schmitt	3-State	2/4/8mA	PD	Vdd2	3ISD/3T2(4)(8)
203	N9	102	126	F8	DIN0/ DMDIN0/ GPIO1B/ EXTINT1B	I/ I/ B/ I	schmitt	3-State	1/2/4mA	PU/PD	Vdd2	3ISUD/3T1(2)(4)
204	M9	-	-		EXD15/ GPIO55/ EXTINT55	B/ B/ I	schmitt	3-State	2/4/8mA	PD	Vdd2	3ISD/3T2(4)(8)
205	N8	103	127	E10	DOUT0/ DMCKO0/ GPIO1C/ EXTINT1C	O/ O/ B/ I	schmitt	3-State	1/2/4mA	PU/PD	Vdd2	3ISUD/3T1(2)(4)
206	P7	104	128	D11	NRES	I	schmitt	-	-	-	Vdd2	3IS
207	L9	105	129	D12	BMODE0	B	schmitt	3-State	2mA	PU/PD	Vdd2	3ISUD/3T2
208	K9	106	130	F9	BMODE1	B	schmitt	3-State	2mA	PU/PD	Vdd2	3ISUD/3T2
209	J9	107	131	F10	TEST	I	schmitt	-	-		Vdd2	3IS
210	P8	108	132	E11	Vdd2	P						
211	H8	109	133	E12	Vss	G						
212	P9	110	134	G10	Vdd1	P						
213	R5	111	135	F11	AVssDAMPR	G						
214	R6	112	136	F12	ROUT/ GPROUT	O/ O	-	1A	-	-	AVddDAMPR	1A
215	R7	113	137	G11	AVddDAMPR	P						
216	R8	114	138	G12	AVddDAMPL	P						
217	R9	115	139	H12	LOUT/ GPLOUT	O/ O	-	1A	-	-	AVddDAMPL	1A
218	R10	116	140	H11	AVssDAMPL	G						
219	P10	-	-		Vdd1	P						
220	N11	117	141	H10	Vss	G						
(*3)		(*2)	142	J12	AVddPLL3	P						
			143	J11	VCNT3	O	-	3A	-	-	AVddPLL3	3A
221	P12	118	144	J10	AVssPLL2	G						
222	R12	119	145	K11	VCNT2	O	-	1A	-	-	AVddPLL2	1A
223	R13	120	146	K12	AVddPLL2	P						
224	P11	121	147	G9	Vdd1	P						
225	R11	-	-		Vss	G						
226	N12	-	-		Vdd2	P						
227	M10	122	148	H9	GPIO2D/ EXTINT2D/ DMCKO0/ SDRADDR11	B/ I/ O/ O	schmitt	3-State	2/4/8mA	PU/PD	Vdd2	3ISUD/3T2(4)(8)
228	L10	-	-		SDRADDR0	O	-	3-State	2/4/8mA		Vdd2	3T2(4)(8)
229	K10	123	149	G8	GPIO2E/ EXTINT2E	B/ I	schmitt	3-State	1/2/4mA	PU/PD	Vdd2	3ISUD/3T1(2)(4)
230	J10	-	-		SDRADDR1	O	-	3-State	2/4/8mA		Vdd2	3T2(4)(8)
231	N10	-	-		SDRADDR2	O	-	3-State	2/4/8mA		Vdd2	3T2(4)(8)
232	M11	124	150	L12	GPIO2F/ EXTINT2F	B/ I	schmitt	3-State	1/2/4mA	PU/PD	Vdd2	3ISUD/3T1(2)(4)
233	P13	125	151	L11	Vss	G						
234	L11	126	152	K10	SCL1/ GPIO2B/ EXTINT2B	O/ B/ I	schmitt	3-State	1/2/4mA	PU/PD	Vdd2	3ISUD/3T1(2)(4)
235	R14	127	153	M12	Vdd2	P						
236	K11	128	154	J9	SDA1/ GPIO2C/ EXTINT2C	B/ B/ I	schmitt	3-State	1/2/4mA	PU/PD	Vdd2	3ISUD/3T1(2)(4)

LC823450

237	M12	-	-		SDRDATA0	B	CMOS	3-State	2/4/8mA	PD	Vdd2	3ICD/3T2(4)(8)
238	N13	-	-		SDRDATA1	B	CMOS	3-State	2/4/8mA	PD	Vdd2	3ICD/3T2(4)(8)
239	P14	-	-		SDRADDR3	O	-	3-State	2/4/8mA		Vdd2	3T2(4)(8)
240	R15	-	-		SDRADDR4	O	-	3-State	2/4/8mA		Vdd2	3T2(4)(8)

(*1) RTCINT (open drain Output) 3.6V tolerant

(*2) Pin assignment for PLL3 of package TQFP128L is as below

PLL3	
118	AVddPLL3
119	VCNT3
120	AVssPLL2

(*3) PLL3 is unusable in package XBGA240.

3-2 Input/Output Circuit

<p>Attribute : 3IS</p>	<p>Attribute : 1IS</p>
<p>Attribute : 1IC</p>	<p>Attribute : 1ISD</p>
<p>Attribute : 3T2(4)(8)</p>	<p>Attribute : OD3</p>
<p>Attribute : 3ICUD/3T6(8)(10)</p>	<p>Attribute : 3ICD/3T2(4)(8)</p>
<p>Attribute : 3ISUD/3T1(2)(4), /3T2(4)(8), /3T6(8)(10)</p>	<p>Attribute : 3ISUD/3T2</p>

▷ Level Shifter

LC823450

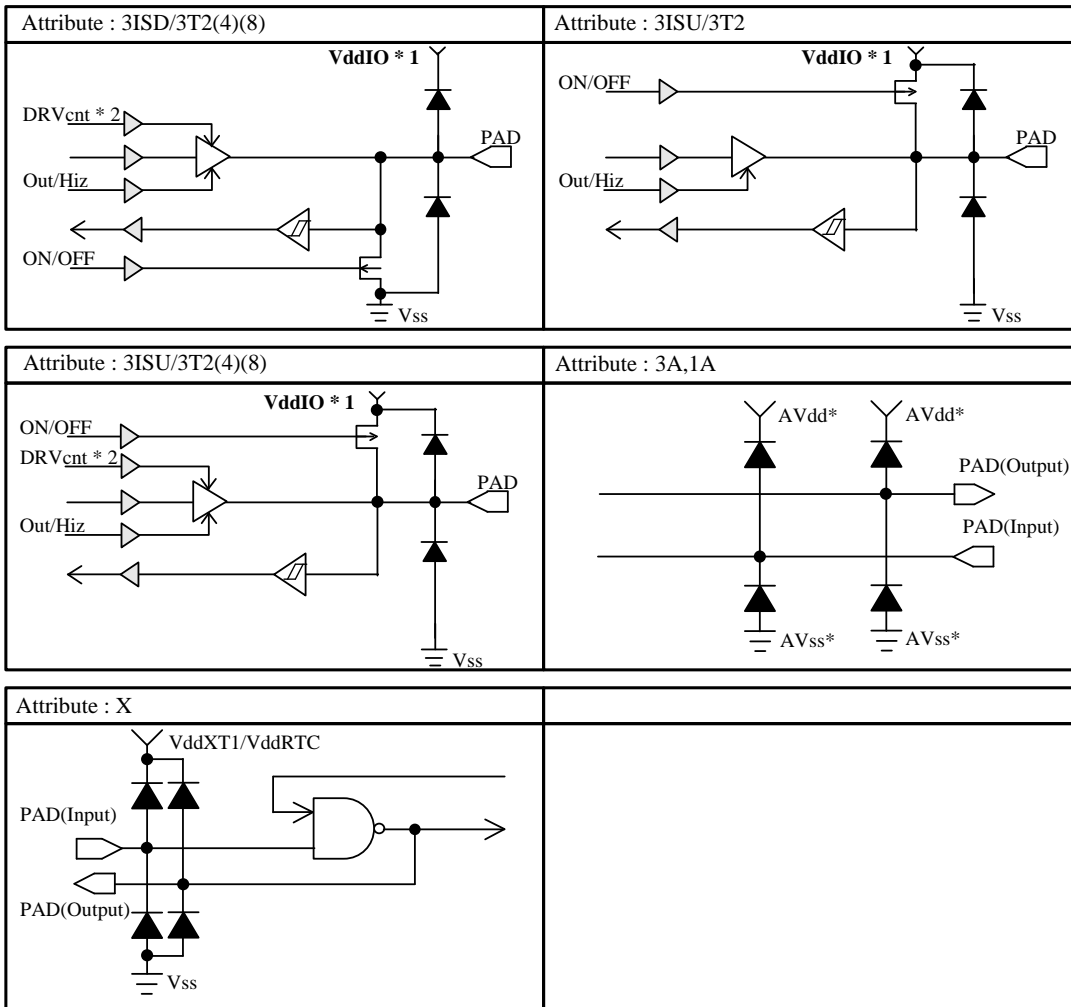

▷ Level Shifter

- * 1 : Vdd2, VddSD0, VddSD1, VddSD2, VddQSPI (IO Pwr Grp of 3-1 Pin Assignment)
- * 2 : DRVcnt : 1/2/4mA, 2/4/8mA, 4/8/10mA, etc. Drivability switch control signal

3-3 Port state table

XBGA240	TQFP128L	WLP154	PIN NAME	(*1) Default Function (NRES=Low)	(*2) Port status NRES=Low(i)	(*2) Port status NRES=High(ii)
●	●	●	TCLKA0/ BCK1/ GPIO00/ EXTINT00	GPIO00	Hiz	Hiz
●	●	●	TCLKB0/ LRCK1/ GPIO01/ EXTINT01	GPIO01	Hiz	Hiz
●	●	●	TIOCB00/ DMDIN0 DIN1/ GPIO02/ EXTINT02/	GPIO02	Hiz	Hiz
●	●	●	TIOCB01/ DMCKO0/ QSCS/ GPIO03/ EXTINT03	GPIO03	PU	PU(*3)
●	●	●	TXD1/ SDAT20/ GPIO04/ EXTINT04	GPIO04	Hiz	Hiz
●	●	●	RXD1/ SDAT21/ GPIO05/ EXTINT05	GPIO05	Hiz	Hiz
●		●	NCS0/ GPIO06/ EXTINT06	GPIO06	Hiz	Hiz
●	●	●	SCL0/ GPIO07/ EXTINT07	GPIO07	Hiz	Hiz
●	●	●	SDA0/ GPIO08/ EXTINT08	GPIO08	Hiz	Hiz
●	●	●	TIOCA00/ SDCLK2/ PHI0/ GPIO09/ EXTINT09	GPIO09	Hiz	Hiz
●	●	●	TIOCA01/ SDCMD2/ PHI1/ GPIO0A/ EXTINT0A	GPIO0A	Hiz	Hiz
●	●	●	TXD2/ TIOCA10/ GPIO0B/ EXTINT0B	GPIO0B	Hiz	Hiz
●	●	●	RXD2/ TIOCA11/ GPIO0C/ EXTINT0C	GPIO0C	Hiz	Hiz
●	●	●	SCK1/ GPIO0D/ EXTINT0D	GPIO0D	Hiz	Hiz
●	●	●	SDI1(QIO0)/ GPIO0E/ EXTINT0E	GPIO0E	Hiz	Hiz

LC823450

●	●	●	SDO1(QIO1)/ GPIO0F/ EXTINT0F	GPIO0F	Hiz	Hiz
●		●	NCS1/ RXD0/ GPIO10/ EXTINT10	GPIO10	Hiz	Hiz
●	●	●	SWP1(QIO2)/ GPIO11/ EXTINT11	GPIO11	Hiz	Hiz
●	●	●	SHOLD1(QIO3)/ GPIO12/ EXTINT12	GPIO12	Hiz	Hiz
●		●	BCK1/ GPIO13/ EXTINT13	GPIO13	Hiz	Hiz
●		●	LRCK1/ GPIO14/ EXTINT14	GPIO14	Hiz	Hiz
●	●	●	DOU1/ GPIO15/ EXTINT15	GPIO15	Hiz	Hiz
●		●	NLBEXA0/ GPIO16/ EXTINT16	GPIO16	Hiz	Hiz
●		●	NRD/ GPIO17/ EXTINT17	GPIO17	Hiz	Hiz
●	●	●	MCLK0/ MCLK1/ GPIO18/ EXTINT18	GPIO18	Hiz	Hiz
●	●	●	BCK0/ DMCKO1/ GPIO19/ EXTINT19	GPIO19	Hiz	Hiz
●	●	●	LRCK0/ DMDIN1/ GPIO1A/ EXTINT1A	GPIO1A	Hiz	Hiz
●	●	●	DIN0/ DMDIN0/ GPIO1B/ EXTINT1B	GPIO1B	Hiz	Hiz
●	●	●	DOU0/ DMCKO0/ GPIO1C/ EXTINT1C	GPIO1C	Hiz	Hiz
●	●	●	SCK0/ GPIO1D/ EXTINT1D	GPIO1D	Hiz	Hiz
●	●	●	SDI0/ GPIO1E/ EXTINT1E	GPIO1E	Hiz	Hiz
●	●	●	SDO0/ GPIO1F/ EXTINT1F	GPIO1F	Hiz	Hiz
●	●	●	TDI/ SDCD1/ SWO/ GPIO20/ EXTINT20	GPIO20	Hiz	Hiz

LC823450

●	●	●	TDO/ SDWP1/ INS/ GPIO21/ EXTINT21	GPIO21	Hiz	Hiz
●	●	●	SDCLK1/ SCLK/ GPIO22/ EXTINT22	GPIO22	Hiz	Hiz
●	●	●	SDCMD1/ BS/ GPIO23/ EXTINT23	GPIO23	Hiz	Hiz
●	●	●	SDAT10/ DATA0/ GPIO24/ EXTINT24	GPIO24	Hiz	Hiz
●	●	●	SDAT11/ DATA1/ GPIO25/ EXTINT25	GPIO25	Hiz	Hiz
●	●	●	SDAT12/ DATA2/ GPIO26/ EXTINT26	GPIO26	Hiz	Hiz
●	●	●	SDAT13/ DATA3/ GPIO27/ EXTINT27	GPIO27	Hiz	Hiz
●	●	●	TMS/ SDWP2/ GPIO28/ EXTINT28	GPIO28	Hiz	Hiz
●	●	●	TCK/ SDCD2/ GPIO29/ EXTINT29	GPIO29	Hiz	Hiz
●			GPIO2A/ EXTINT2A/ SDRADDR12	GPIO2A	Hiz	Hiz
●	●	●	SCL1/ GPIO2B/ EXTINT2B	GPIO2B	Hiz	Hiz
●	●	●	SDA1/ GPIO2C/ EXTINT2C	GPIO2C	Hiz	Hiz
●	●	●	GPIO2D/ EXTINT2D/ DMCKO0/ SDRADDR11	GPIO2D	Hiz	Hiz
●	●	●	GPIO2E/ EXTINT2E	GPIO2E	Hiz	Hiz(*4)
●	●	●	GPIO2F/ EXTINT2F	GPIO2F	Hiz	Hiz(*5)
●		●	NWRENWRL/ GPIO30/ EXTINT30	GPIO30	Hiz	Hiz
●		●	NHBNWRH/ TXD0/ GPIO31/ EXTINT31	GPIO31	Hiz	Hiz
●			EXA1/ GPIO32/ EXTINT32	GPIO32	Hiz	Hiz

LC823450

●			EXA2/ GPIO33/ EXTINT33	GPIO33	Hiz	Hiz
●			EXA3/ GPIO34/ EXTINT34	GPIO34	Hiz	Hiz
●			EXA4/ GPIO35/ EXTINT35	GPIO35	Hiz	Hiz
●			EXA5/ GPIO36/ EXTINT36	GPIO36	Hiz	Hiz
●			EXA6/ GPIO37/ EXTINT37	GPIO37	Hiz	Hiz
●			EXA7/ GPIO38/ EXTINT38	GPIO38	Hiz	Hiz
●			EXA8/ GPIO39/ EXTINT39	GPIO39	Hiz	Hiz
●			EXA9/ GPIO3A/ EXTINT3A	GPIO3A	Hiz	Hiz
●			EXA10/ GPIO3B/ EXTINT3B	GPIO3B	Hiz	Hiz
●			EXA11/ GPIO3C/ EXTINT3C	GPIO3C	Hiz	Hiz
●			EXA12/ GPIO3D/ EXTINT3D	GPIO3D	Hiz	Hiz
●			EXA13/ GPIO3E/ EXTINT3E	GPIO3E	Hiz	Hiz
●			EXA14/ GPIO3F/ EXTINT3F	GPIO3F	Hiz	Hiz
●			EXA15/ GPIO40/ EXTINT40	GPIO40	Hiz	Hiz
●			EXA16/ GPIO41/ EXTINT41	GPIO41	Hiz	Hiz
●			EXA17/ GPIO42/ EXTINT42	GPIO42	Hiz	Hiz
●			EXA18/ GPIO43/ EXTINT43	GPIO43	Hiz	Hiz
●			EXA19/ GPIO44/ EXTINT44	GPIO44	Hiz	Hiz
●			EXA20/ GPIO45/ EXTINT45	GPIO45	Hiz	Hiz
●		●	EXD0/ GPIO46/ EXTINT46	GPIO46	Hiz	Hiz
●		●	EXD1/ GPIO47/ EXTINT47	GPIO47	Hiz	Hiz

LC823450

●		●	EXD2/ GPIO48/ EXTINT48	GPIO48	Hiz	Hiz
●		●	EXD3/ GPIO49/ EXTINT49	GPIO49	Hiz	Hiz
●		●	EXD4/ GPIO4A/ EXTINT4A	GPIO4A	Hiz	Hiz
●		●	EXD5/ GPIO4B/ EXTINT4B	GPIO4B	Hiz	Hiz
●		●	EXD6/ GPIO4C/ EXTINT4C	GPIO4C	Hiz	Hiz
●		●	EXD7/ GPIO4D/ EXTINT4D	GPIO4D	Hiz	Hiz
●			EXD8/ GPIO4E/ EXTINT4E	GPIO4E	Hiz	Hiz
●			EXD9/ GPIO4F/ EXTINT4F	GPIO4F	Hiz	Hiz
●			EXD10/ GPIO50/ EXTINT50	GPIO50	Hiz	Hiz
●			EXD11/ GPIO51/ EXTINT51	GPIO51	Hiz	Hiz
●			EXD12/ GPIO52/ EXTINT52	GPIO52	Hiz	Hiz
●			EXD13/ GPIO53/ EXTINT53	GPIO53	Hiz	Hiz
●			EXD14/ GPIO54/ EXTINT54	GPIO54	Hiz	Hiz
●			EXD15/ GPIO55/ EXTINT55	GPIO55	Hiz	Hiz
●	●	●	CTS1/ SDAT22/ RXD0/ GPIO56/ EXTINT56	GPIO56	Hiz	Hiz
●	●	●	RTS1/ SDAT23/ TXD0/ GPIO57/ EXTINT57	GPIO57	Hiz	Hiz
●	●	●	SDAT00	SDAT00	Hiz	Hiz
●	●	●	SDAT01	SDAT01	Hiz	Hiz
●	●	●	SDAT02	SDAT02	Hiz	Hiz
●	●	●	SDAT03	SDAT03	Hiz	Hiz
●	●	●	SDCLK0	SDCLK0	Low	Low
●	●	●	SDCMD0	SDCMD0	Hiz	Hiz
●			SDRADDR0	SDRADDR0	Low	Low
●			SDRADDR1	SDRADDR1	Low	Low
●			SDRADDR10	SDRADDR10	Low	Low
●			SDRADDR2	SDRADDR2	Low	Low
●			SDRADDR3	SDRADDR3	Low	Low

LC823450

●			SDRADDR4	SDRADDR4	Low	Low
●			SDRADDR5	SDRADDR5	Low	Low
●			SDRADDR6	SDRADDR6	Low	Low
●			SDRADDR7	SDRADDR7	Low	Low
●			SDRADDR8	SDRADDR8	Low	Low
●			SDRADDR9	SDRADDR9	Low	Low
●			SDRBA0	SDRBA0	Low	Low
●			SDRBA1	SDRBA1	Low	Low
●			SDRCAS	SDRCAS	High	High
●			SDRCKE	SDRCKE	High	High
●			SDRCLK	SDRCLK	Low	Low
●			SDRCS	SDRCS	High	High
●			SDRDATA0	SDRDATA0	Hiz	Hiz
●			SDRDATA1	SDRDATA1	Hiz	Hiz
●			SDRDATA10	SDRDATA10	Hiz	Hiz
●			SDRDATA11	SDRDATA11	Hiz	Hiz
●			SDRDATA12	SDRDATA12	Hiz	Hiz
●			SDRDATA13	SDRDATA13	Hiz	Hiz
●			SDRDATA14	SDRDATA14	Hiz	Hiz
●			SDRDATA15	SDRDATA15	Hiz	Hiz
●			SDRDATA2	SDRDATA2	Hiz	Hiz
●			SDRDATA3	SDRDATA3	Hiz	Hiz
●			SDRDATA4	SDRDATA4	Hiz	Hiz
●			SDRDATA5	SDRDATA5	Hiz	Hiz
●			SDRDATA6	SDRDATA6	Hiz	Hiz
●			SDRDATA7	SDRDATA7	Hiz	Hiz
●			SDRDATA8	SDRDATA8	Hiz	Hiz
●			SDRDATA9	SDRDATA9	Hiz	Hiz
●			SDRDQM0	SDRDQM0	High	High
●			SDRDQM1	SDRDQM1	High	High
●			SDRRAS	SDRRAS	High	High
●			SDRWE	SDRWE	High	High
●	●	●	SWDCLK/ GPIO58/ EXTINT58/ DMCKO1	SWDCLK	Hiz	Hiz
●	●	●	SWDIO/ GPIO59/ EXTINT59/ DMDIN1	SWDIO	Hiz	Hiz
●	●	●	NRES	NRES	Hiz	Hiz
●	●	●	TEST	TEST	Hiz	Hiz
●		●	XTALINFO0	XTALINFO0	Hiz	Hiz
●		●	XTALINFO1	XTALINFO1	Hiz	Hiz
●	●	●	BMODE0	BMODE0	Hiz	Hiz
●	●	●	BMODE1	BMODE1	Hiz	Hiz
●		●	RTCMODE	RTCMODE	Hiz	Hiz
●		●	KEYINT0	KEYINT0	PD	PD
●		●	KEYINT1	KEYINT1	PD	PD
●		●	KEYINT2	KEYINT2	PD	PD
●	●	●	BACKUPB	BACKUPB	Hiz	Hiz
●	●	●	RTCINT	RTCINT	-(Not Determined)	-(Not Determined)

LC823450

●	●	●	VDET	VDET	Hiz	Hiz
●	●	●	LOUT/ GPOUT	LOUT	Hiz	Hiz
●	●	●	ROUT/ GPROUT	ROUT	Hiz	Hiz
●	●	●	USBDM	USBDM	Hiz	Hiz
●	●	●	USBDP	USBDP	Hiz	Hiz
●	●	●	USBEXT12	USBEXT12	-(Not Applicable)	-(Not Applicable)
●	●	●	VCNT1	VCNT1	-(Not Applicable)	-(Not Applicable)
●(*6)	●(*6)	●	VCNT2	VCNT2	-(Not Applicable)	-(Not Applicable)
		●	VCNT3	VCNT3	-(Not Applicable)	-(Not Applicable)
●	●	●	AN0	AN0	-(Not Applicable)	-(Not Applicable)
●	●	●	AN1	AN1	-(Not Applicable)	-(Not Applicable)
●	●	●	AN2	AN2	-(Not Applicable)	-(Not Applicable)
●	●	●	AN3	AN3	-(Not Applicable)	-(Not Applicable)
●	●	●	AN4	AN4	-(Not Applicable)	-(Not Applicable)
●	●	●	AN5	AN5	-(Not Applicable)	-(Not Applicable)
●			VR	VR	-(Not Applicable)	-(Not Applicable)
●			VRH	VRH	-(Not Applicable)	-(Not Applicable)
●			VRL	VRL	-(Not Applicable)	-(Not Applicable)
●	●	●	XIN1	XIN1	-(Not Applicable)	-(Not Applicable)
●	●	●	XIN32K	XIN32K	-(Not Applicable)	-(Not Applicable)
●	●	●	XOUT1	XOUT1	-(Not Applicable)	-(Not Applicable)
●	●	●	XOUT32K	XOUT32K	-(Not Applicable)	-(Not Applicable)

[Note]

● means a port is available for each package. "PD" means pull down

(*1) Default function is port function set by NRES=Low

(*2) NRES=High(ii) occurs just after NRES=Low(i)

(*3) This port is set to output port and PU is disabled to be used as QSCS for SPI I/F chip select during serial flash boot mode.

(*4) This port is set to output port to be used as external power control during Internal ROM boot.

(*5) This port is set to output port to be used as boot monitor port during Internal ROM boot.

(*6) One of VCNT2 or VCNT3 is available

4 Electrical Specification

Product parametric performance is indicated in the Electrical Characteristics for the listed test conditions, unless otherwise noted. Product performance may not be indicated by the Electrical Characteristics if operated under different conditions.

4-1 Maximum Ratings (*1)

Vss = 0V

Item	Symbol	Condition	Ratings	Unit
Maximum power supply voltage	Vdd1 VddRTC VddXT1 AVddUSBPH Y1 DVddUSBPH Y1 AVddPLL1 AVddPLL2		-0.5 to 1.8	V
	AVddDAMPL AVddDAMPR		-0.5 to 2.5	V
	Vdd2 VddSD0 VddSD1 VddSD2 VddQSPI AVddPLL3 AVddADC AVddUSBPH Y2		-0.5 to 4.6	V
Input voltage	V _I		-0.5 to *Vdd*+0.5	V
	V _{IUSB}	USBDP,USB DM terminal	-0.5 to AVddUSBPHY2+0.5(<4.6)	V
Operating ambient temperature	Topr		-20 to +65	°C
Ambient temperature of preservation	Tstg		-55 to +125	°C

(*1) Stresses exceeding those listed in the Maximum Ratings table may damage the device. If any of these limits are exceeded, device functionality should not be assumed, damage may occur and reliability may be affected.

LC823450

4-2 Recommended Operating Conditions (*1)

Ta = -20°C to +65°C

Item	Symbol	Condition	Low voltage operation(*2)			High voltage operation(*2)			Unit	
			Min	Typ	Max	Min	Typ	Max		
Power supply voltage	Vdd1		0.93	1.0	1.27	1.1	1.2	1.27	V	
	VddXT1	(*3)	0.93	1.0	1.3	0.93	1.2	1.3	V	
	AVddPLL1		0.93	1.0	1.3	1.1	1.2	1.3	V	
	AVddPLL2		0.9	1.0	1.3	0.9	1.2	1.3	V	
	AVddPLL3		2.7	3.3	3.6	same as left			V	
	VddRTC		0.9	1.0	1.1	same as left			V	
	Vdd2			2.7	3.3	3.6	same as left			V
				1.7	1.8	1.95	same as left			V
	VddSD0			2.7	3.3	3.6	same as left			V
				1.7	1.8	1.95	same as left			V
	VddSD1			2.7	3.3	3.6	same as left			V
				1.7	1.8	1.95	same as left			V
	VddSD2			2.7	3.3	3.6	same as left			V
				1.7	1.8	1.95	same as left			V
	VddQSPI			2.7	3.3	3.6	same as left			V
				1.7	1.8	1.95	same as left			V
	AVddADC		2.7	3.3	3.6	same as left			V	
	AVddUSB PHY1	(*4)		0.93	1.2	1.3	same as left			V
		(*5)		1.08	1.2	1.3	same as left			V
	DVddUSB PHY1	(*4)		0.93	1.2	1.3	same as left			V
(*5)			1.08	1.2	1.3	same as left			V	
AVddUSB PHY2	(*4)		2.7	3.3	3.6	same as left			V	
	(*5)		3.0	3.3	3.6	same as left			V	
AVddDAM PL			0.93	1.2	1.65	same as left			V	
	(*6)		0.93	1.2	1.95	same as left			V	
AVddDAM PR			0.93	1.2	1.65	same as left			V	
	(*6)		0.93	1.2	1.95	same as left			V	
Input range	VIN		0		*Vdd*	same as left			V	

(*1) Functional operation above the stresses listed in the Recommended Operating Ranges is not implied. Extended exposure to stresses beyond the Recommended Operating Ranges limits may affect device reliability.

(*2) Follow the operating frequency specifications because the operating frequency ranges are specified according to the operating voltage ranges.

(*3) Regarding Xtal frequency range, refer to the detailed datasheet.

(*4) While USB is not used.

(*5) While USB is used (including USB suspend mode)

(*6) While used as GPO (general purpose output) the output of which can be controlled by registers

(*7) · Power domains of Vdd1, AVddUSBPHY1=DVddUSBPHY1, AVddPLL1, AVddPLL2, AVddPLL3, VddXT1 are divided, and different voltage can be supplied.

- Power domains of Vdd2, VddSD0, VddSD1, VddSD2, VddQSPI, AVddADC, AVddUSBPHY2, AVddPLL3, AVddDAMPL=AVddDAMPR are divided, and difference voltage can be supplied.

- If power is supplied to one of the power supply pins above, all of other power supply pins should be supplied.

- VddRTC can be supplied if BACKUPB is set to low, while other power supply pins are not supplied.

LC823450

Item	Symbol	Function	Low voltage operation			High voltage operation			Unit
			Min	Typ	Max	Min	Typ	Max	
Xtal Input frequency	Fxin1	System, Audio clock (XT1 oscillator)	12MHz or 20MHz tolerance : ± 200 ppm or less Jitter : ± 50 ps or less (*4)			12MHz or 20MHz or 24MHz or 48MHz tolerance : ± 200 ppm or less Jitter : ± 50 ps or less (*4)			-
	FxinRTC	RTC clock (XTRTC oscillator)	32.768kHz Jitter : ± 500 ps or less			same as left			-
	Frc	RC (RC oscillator)	0.4 (*5)	1 (*5)	2 (*5)	same as left			MHz
Time for Xtal stable	Txin1				3 (*7)	same as left			ms
	TxinRTC				1000 (*7)	same as left			ms
Internal clock frequency	Farm	Cortex-M3	0		100	0		160(*6)	MHz
	Fahb	AHB	0		100	0		160(*6)	MHz
	Fapb	APB	0		100	0		160(*6)	MHz
	Fdsp	DSP	0		100	0		160(*6)	MHz
	Faud(*1)	AUDCLK(768fs)	0	33.8688	147.456	same as left			MHz
	Fdec	DECCLK(*2) (MP3 Decoder)	0	16.9344	73.728	same as left			MHz
	Fenc	ENCCLK(*3) (MP3 Encoder)	0	8.4672	36.864	same as left			MHz

(*1) Audio blocks run on $256 * F_s$ (sampling frequency) clock.

However, Class-D AMP, etc run on $384 * F_s$ (sampling frequency).

These clocks are generated from $768 * F_s$ (Base Clock) divided by 3 and 2 respectively.

(*2)MP3 Decoder runs on clock of $384 * F_s$ (sampling frequency of MPEG1 mode).

It runs on the clock of the same frequency as MPEG1 mode during MPEG2 / 2.5 mode. For example, even when operating in MPEG2 / 2.5 mode($F_s = 22.05 / 11.025$ KHz as an example), please supplies 16.9344 MHz(= $384 * 44.1$ KHz) clock which is the same clock frequency as MPEG1 mode.

(*3) MP3 Encoder runs on clock of $192 * F_s$ (sampling frequency of MPEG1 mode).

It runs on the clock of the same frequency as MPEG1 mode during MPEG2 / 2.5 mode. For example, even when operating in MPEG2 / 2.5 mode($F_s = 22.05 / 11.025$ KHz as an example), please supplies 8.4672 MHz(= $192 * 44.1$ KHz) clock which is the same clock frequency as MPEG1 mode.

(*4) Refer to the detailed datasheet. If USB function is not used, the specification required may be relaxed. Please contact our representative in detail.

(*5) $V_{dd1} = 0.93V$ to $1.27V$, $T_a = -20^{\circ}C$ to $65^{\circ}C$

(*6) When Farm, Fdsp are over 100MHz, 1 * Wait is required for Cortex-M3 and LPDSP32 to access internal ROM by the register described in the ProgrammersModel_SystemController as memory access control register4.

(*7) These are just reference values under $T_a = 25^{\circ}C$, and need to be adjusted to customer board situation.

LC823450

4-3 DC Characteristics (*1)

Vdd2 = 2.7V to 3.6V, VddRTC = 0.9V to 1.1V, VddSD0 = 2.7V to 3.6V, VddSD1 = 2.7V to 3.6V

VddSD2 = 2.7V to 3.6V, VddQSPI = 2.7V to 3.6V

Ta = -20°C to +65°C

Item	Symbol	Pin	Condition	Min	Typ	Max	Unit
Input H voltage	V _{IH}	(1)	CMOS	0.7×Vdd2			V
		(2)		0.7×VddSD0			V
		(3)		0.7×VddSD1			V
		(4)		0.7×VddSD2			V
		(5)	schmitt	0.75×Vdd2			V
		(21)		0.75×VddSD1			V
		(6)		0.75×VddSD2			V
		(7)		0.75×VddQSPI			V
		(8)	CMOS	0.7×VddRTC			V
(9)	schmitt	0.7×VddRTC			V		
Input L voltage	V _{IL}	(1)	CMOS			0.3×Vdd2	V
		(2)				0.3×VddSD0	V
		(3)				0.3×VddSD1	V
		(4)				0.3×VddSD2	V
		(5)	schmitt			0.25×Vdd2	V
		(21)				0.25×VddSD1	V
		(6)				0.25×VddSD2	V
		(7)				0.25×VddQSPI	V
		(8)	CMOS			0.2×VddRTC	V
(9)	schmitt			0.2×VddRTC	V		
Output H voltage	V _{OH}	(10)(12)	I _{OH} =-1mA	Vdd2-0.4			V
		(11)		VddQSPI-0.4			V
		(10)(13)(14)	I _{OH} =-2mA	Vdd2-0.4			V
		(11)		VddQSPI-0.4			V
		(15)		VddSD1-0.4			V
		(12)		VddSD2-0.4			V
		(10)(13)	I _{OH} =-4mA	Vdd2-0.4			V
		(11)		VddQSPI-0.4			V
		(12)		VddSD2-0.4			V
		(16)	I _{OH} =-6mA	VddQSPI-0.4			V
		(17)		VddSD0-0.4			V
		(18)		VddSD1-0.4			V
		(19)		VddSD2-0.4			V
		(13)	I _{OH} =-8mA	Vdd2-0.4			V
		(16)		VddQSPI-0.4			V
		(17)		VddSD0-0.4			V
		(18)		VddSD1-0.4			V
		(19)		VddSD2-0.4			V
		(16)	I _{OH} =-10mA	VddQSP-0.4			V
		(17)		VddSD0-0.4			V
(18)	VddSD1-0.4				V		
(19)	VddSD2-0.4				V		
Output L voltage	V _{OL}	(10)(12)	I _{OL} =1mA			0.4	V
		(11)				0.4	V

LC823450

		(10)(13)(14)	$I_{OL}=2mA$			0.4	V
		(11)				0.4	V
		(15)				0.4	V
		(12)				0.4	V
		(10)(13)	$I_{OL}=4mA$			0.4	V
		(11)				0.4	V
		(12)				0.4	V
		(16)	$I_{OL}=6mA$			0.4	V
		(17)				0.4	V
		(18)				0.4	V
		(19)				0.4	V
		(13)	$I_{OL}=8mA$			0.4	V
		(16)				0.4	V
		(17)				0.4	V
		(18)				0.4	V
		(19)				0.4	V
		(16)	$I_{OL}=10mA$			0.4	V
		(17)				0.4	V
		(18)				0.4	V
		(19)				0.4	V
(20)	$I_{OL}=0.3mA$			0.3	V		
Pull-up resistor	Rup	(28)		25		75	k Ω
		(29)		10		100	k Ω
		(30)		18		50	k Ω
Pull-down resistor	Rdn	(25)		25		75	k Ω
		(26)		10		100	k Ω
		(27)		10		100	k Ω
Input leak current	I_{IL}	(1)(2) (3)(4) (5)(6) (7)(8) (9)(21)	$V_I=V_{dd}=V_{ss}$	-10		10	μA
Output leak current	I_{oz}	(10)(11) (12)(13) (14)(15) (16)(17) (18)(19) (20)	HiZ output	-10		10	μA

LC823450

Vdd2 = 1.7V to 1.95V, VddSD0 = 1.7V to 1.95V, VddSD1 = 1.7V to 1.95V

VddSD2 = 1.7V to 1.95V, VddQSPI = 1.7V to 1.95V

AVddDAMPL = 0.93V to 1.95V, AVddDAMPR = 0.93V to 1.95V

Ta = -20°C to +65°C

Item	Symbol	Pin	Condition	Min	Typ	Max	Unit
Input H voltage	V _{IH}	(1)	CMOS	0.7×Vdd2			V
		(2)		0.7×VddSD0			V
		(3)		0.7×VddSD1			V
		(4)		0.7×VddSD2			V
		(5)	schmitt	0.75×Vdd2			V
		(21)		0.75×VddSD1			V
		(6)		0.75×VddSD2			V
		(7)		0.75×VddQSPI			V
Input L voltage	V _{IL}	(1)	CMOS			0.3×Vdd2	V
		(2)				0.3×VddSD0	V
		(3)				0.3×VddSD1	V
		(4)				0.3×VddSD2	V
		(5)	schmitt			0.25×Vdd2	V
		(21)				0.25×VddSD1	V
		(6)				0.25×VddSD2	V
		(7)		0.25×VddQSPI			V
Output H voltage	V _{OH}	(10)(12)	I _{OH} = -0.5mA	Vdd2-0.4			V
		(11)		VddQSPI-0.4			V
		(10)(13)(14)	I _{OH} =-1mA	Vdd2-0.4			V
		(11)		VddQSPI-0.4			V
		(15)		VddSD1-0.4			V
		(12)		VddSD2-0.4			V
		(10)(13)	I _{OH} =-2mA	Vdd2-0.4			V
		(11)		VddQSPI-0.4			V
		(12)		VddSD2-0.4			V
		(16)	I _{OH} =-3mA	VddQSPI-0.4			V
		(17)		VddSD0-0.4			V
		(18)		VddSD1-0.4			V
		(19)		VddSD2-0.4			V
		(13)	I _{OH} =-4mA	Vdd2-0.4			V
		(16)		VddQSPI-0.4			V
		(17)		VddSD0-0.4			V
		(18)		VddSD1-0.4			V
		(19)		VddSD2-0.4			V
		(23)	I _{OH} =-8mA (*1)	AVddDAMPL- 0.4			V
		(24)	I _{OH} =-8mA (*1)	AVddDAMPR- 0.4			V
(16)	I _{OH} =-5mA	VddQSPI-0.4			V		
(17)		VddSD0-0.4			V		
(18)		VddSD1-0.4			V		
(19)		VddSD2-0.4			V		
Output L voltage	V _{OL}	(10)(11)(12)	I _{OL} =0.5mA			0.4	V
		(10)(13)(14)	I _{OL} =1mA			0.4	V
		(11)				0.4	V

LC823450

		(15)				0.4	V	
		(12)				0.4	V	
		(10)(13)	I _{OL} =2mA			0.4	V	
		(11)					0.4	V
		(12)				0.4	V	
		(16)	I _{OL} =3mA			0.4	V	
		(17)					0.4	V
		(18)					0.4	V
		(19)					0.4	V
		(13)	I _{OL} =4mA			0.4	V	
		(16)					0.4	V
		(17)					0.4	V
		(18)					0.4	V
		(19)					0.4	V
		(23)	I _{OL} =8mA (*2)			0.4	V	
		(24)	I _{OL} =8mA (*2)			0.4	V	
		(16)	I _{OL} =5mA			0.4	V	
		(17)					0.4	V
		(18)					0.4	V
		(19)					0.4	V
Pull-up resistor	Rup	(28)		25		75	kΩ	
		(29)		30		200	kΩ	
		(30)		18		50	kΩ	
Pull-down resistor	Rdn	(25)		25		75	kΩ	
		(26)		30		200	kΩ	
Input leak current	I _{IL}	(1)(2) (3)(4) (5)(6) (7)(8) (9)(21)	V _I =V _{dd} *= V _{ss}	-10		10	μA	
Output leak current	I _{oz}	(10)(11) (12)(13) (14)(15) (16)(17) (18)(19)	HiZ output	-10		10	μA	
		(23)(24)		-10		10	μA	

(*1) Product parametric performance is indicated in the Electrical Characteristics for the listed test conditions, unless otherwise noted. Product performance may not be indicated by the Electrical Characteristics if operated under different conditions.

(*2) Set DAMPCTL register as below.

• DZCTL : DSLEEP=1. (don't care DSL value)

• DZINP : DZINP14=1, other DZINPx=0

This DC characteristics can be applied while Class-D AMP used as GPO.

LC823450

- (26) SDRDATA9,SDRDATA8,SDRDATA7,SDRDATA6,SDRDATA5,SDRDATA4,SDRDATA3,SDRDATA2,SDRDATA15,SDRDATA14,SDRDATA13,SDRDATA12,SDRDATA11,SDRDATA10,SDRDATA1,SDRDATA0,SDCMD0,SDAT03,SDAT02,SDAT01,SDAT00,TCLKA0(GPIO00),TCLKB0(GPIO01),TIOCB00(GPIO02),TIOCB01(GPIO03),TXD1(GPIO04),RXD1(GPIO05),SCL0(GPIO07),SDA0(GPIO08),TIOCA00(GPIO09),TIOCA01(GPIO0A),TXD2(GPIO0B),RXD2(GPIO0C),SCK1(GPIO0D),SDI1(QIO0)(GPIO0E),SDO1(QIO1)(GPIO0F),SWP1(QIO2)(GPIO11),SHOLD1(QIO3)(GPIO12),BCK1(GPIO13),LRCK1(GPIO14),DOUT1(GPIO15),NLBEXA0(GPIO16),NRD(GPIO17),MCLK0(GPIO18),BCK0(GPIO19),LRCK0(GPIO1A),DIN0(GPIO1B),DOUT0(GPIO1C),SCK0(GPIO1D),SDI0(GPIO1E),SDO0(GPIO1F),TDI(GPIO20),TDO(GPIO21),SDCLK1(GPIO22),SDCMD1(GPIO23),SDAT10(GPIO24),SDAT11(GPIO25),SDAT12(GPIO26),SDAT13(GPIO27),TMS(GPIO28),TCK(GPIO29),SDRADDR12(GPIO2A),SCL1(GPIO2B),SDA1(GPIO2C),SDRADDR11(GPIO2D),EXTINT2E(GPIO2E),EXTINT2F(GPIO2F),NWRENWRL(GPIO30),NHBNWRH(GPIO31),EXA1(GPIO32),EXA2(GPIO33),EXA3(GPIO34),EXA4(GPIO35),EXA5(GPIO36),EXA6(GPIO37),EXA7(GPIO38),EXA8(GPIO39),EXA9(GPIO3A),EXA10(GPIO3B),EXA11(GPIO3C),EXA12(GPIO3D),EXA13(GPIO3E),EXA14(GPIO3F),EXA15(GPIO40),EXA16(GPIO41),EXA17(GPIO42),EXA18(GPIO43),EXA19(GPIO44),EXA20(GPIO45),EXD0(GPIO46),EXD1(GPIO47),EXD2(GPIO48),EXD3(GPIO49),EXD4(GPIO4A),EXD5(GPIO4B),EXD6(GPIO4C),EXD7(GPIO4D),EXD8(GPIO4E),EXD9(GPIO4F),EXD10(GPIO50),EXD11(GPIO51),EXD12(GPIO52),EXD13(GPIO53),EXD14(GPIO54),EXD15(GPIO55),CTS1(GPIO56),RTS1(GPIO57),SWDCLK(GPIO58)
- (27) KEYINT2,KEYINT1,KEYINT0
- (28) SDCMD0,SDAT03,SDAT02,SDAT01,SDAT00,BMODE1,BMODE0,TXD1(GPIO04),RXD1(GPIO05),TIOCA00(GPIO09),TIOCA01(GPIO0A),SDCLK1(GPIO22),SDCMD1(GPIO23),SDAT10(GPIO24),SDAT11(GPIO25),SDAT12(GPIO26),SDAT13(GPIO27),CTS1(GPIO56),RTS1(GPIO57)
- (29) TCLKA0(GPIO00),TCLKB0(GPIO01),TIOCB00(GPIO02),TIOCB01(GPIO03),NCS0(GPIO06),SCL0(GPIO07),SDA0(GPIO08),TXD2(GPIO0B),RXD2(GPIO0C),SCK1(GPIO0D),SDI1(QIO0)(GPIO0E),SDO1(QIO1)(GPIO0F),NCS1(GPIO10),SWP1(QIO2)(GPIO11),SHOLD1(QIO3)(GPIO12),BCK1(GPIO13),LRCK1(GPIO14),DOUT1(GPIO15),MCLK0(GPIO18),BCK0(GPIO19),LRCK0(GPIO1A),DIN0(GPIO1B),DOUT0(GPIO1C),SCK0(GPIO1D),SDI0(GPIO1E),SDO0(GPIO1F),TDI(GPIO20),TDO(GPIO21),TMS(GPIO28),TCK(GPIO29),SDRADDR12(GPIO2A),SCL1(GPIO2B),SDA1(GPIO2C),SDRADDR11(GPIO2D),EXTINT2E(GPIO2E),EXTINT2F(GPIO2F),SWDCLK(GPIO58),SWDIO(GPIO59),XTALINFO1,XTALINFO0
- (30) SDCMD0,SDAT03,SDAT02,SDAT01,SDAT00

(Note)

DC characteristics for the pins below are not included

VR, VRH, VRL, USBDM, USBDP, USBEXT12, VCNT1, VCNT2, VCNT3, AN0, AN1, AN2, AN3, AN4, AN5, XIN1, XIN32K, XOUT1, XOUT32K, LOUT (Class-D AMP), ROUT (Class-D AMP)

LC823450

5 Application Diagram

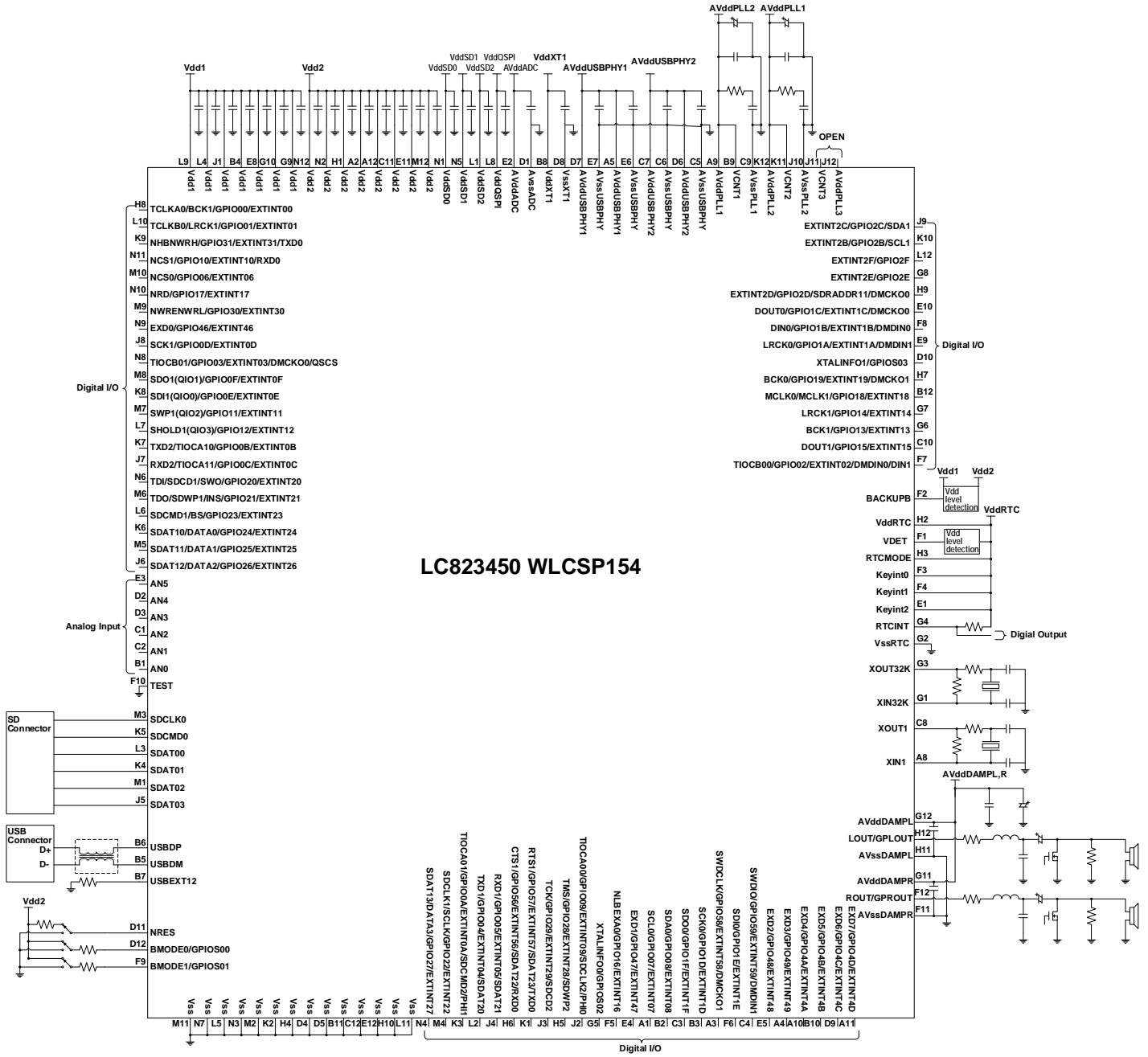

LC823450

PACKAGE DIMENSIONS

unit : mm

[LC823450TA-2H]

TQFP128 14x14 / TQFP128L

CASE 932BA

ISSUE A

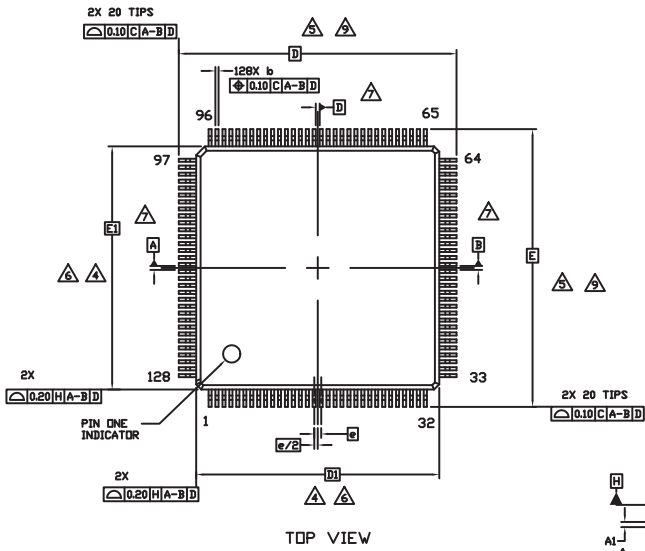

TOP VIEW

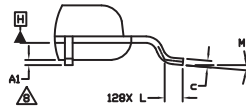

DETAIL A

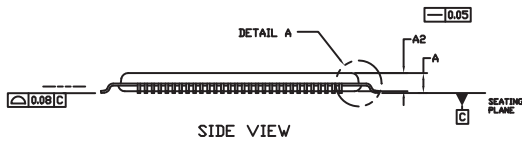

SIDE VIEW

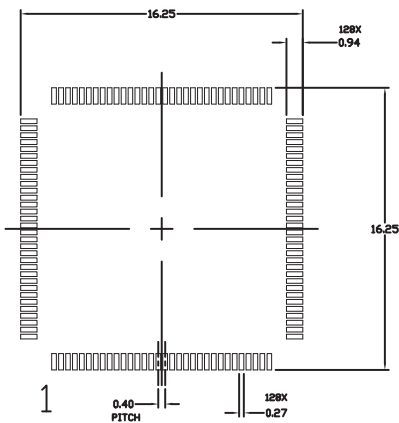

RECOMMENDED MOUNTING FOOTPRINT

NOTES:

1. DIMENSIONING AND TOLERANCING PER ASME Y14.5M, 1994.
2. CONTROLLING DIMENSION: MILLIMETERS
3. DIMENSION b DOES NOT INCLUDE DAMBAR PROTRUSION. DAMBAR PROTRUSION SHALL BE 0.08 MAX. AT MMC. DAMBAR CANNOT BE LOCATED ON THE LOWER RADIUS OF THE FOOT. MINIMUM SPACE BETWEEN PROTRUSION AND ADJACENT LEAD IS 0.07.
4. DIMENSIONS D1 AND E1 DO NOT INCLUDE MOLD FLASH, PROTRUSIONS, OR GATE BURRS. MOLD FLASH, PROTRUSIONS, OR GATE BURRS SHALL NOT EXCEED 0.25 PER SIDE. DIMENSIONS D1 AND E1 ARE MAXIMUM PLASTIC BODY SIZE INCLUDING MOLD MISMATCH.
5. THE TOP PACKAGE BODY SIZE MAY BE SMALLER THAN THE BOTTOM PACKAGE SIZE BY AS MUCH AS 0.15.
6. DIMENSIONS D1 AND E1 TO BE DETERMINED AT DATUM PLANE H.
7. DATUMS A-B AND D ARE DETERMINED AT DATUM PLANE H.
8. A1 IS DEFINED AS THE VERTICAL DISTANCE FROM THE SEATING PLANE TO THE LOWEST POINT ON THE PACKAGE BODY.
9. DIMENSIONS D AND E TO BE DETERMINED AT DATUM PLANE C.

MILLIMETERS		
DIM	MIN.	MAX.
A	---	1.20
A1	0.05	0.15
A2	1.00 REF	
b	0.13	0.23
c	0.09	0.20
D	16.00	BSC
D1	14.00	BSC
E	16.00	BSC
E1	14.00	BSC
e	0.40	BSC
L	0.45	0.75
M	0"	7"

GENERIC MARKING DIAGRAM*

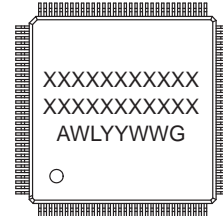

- A = Assembly Location
- WL = Wafer Lot
- YY = Year
- WW = Work Week
- G = Pb-Free Package

*This information is generic. Please refer to device data sheet for actual part marking. Pb-Free indicator, "G" or microdot "▪", may or may not be present.

LC823450

PACKAGE DIMENSIONS

unit : mm

[LC823450XATBG, LC823450XBTBG, LC823450XCTBG, LC823450XDTBG]

* The diameter of footprint of the solder ball is as follows.

Package Code	Size of the footprint
XA, XB	φ 0.20
XC, XD	φ 0.22

WLCSP154, 5.52x5.33

CASE 567LD

ISSUE A

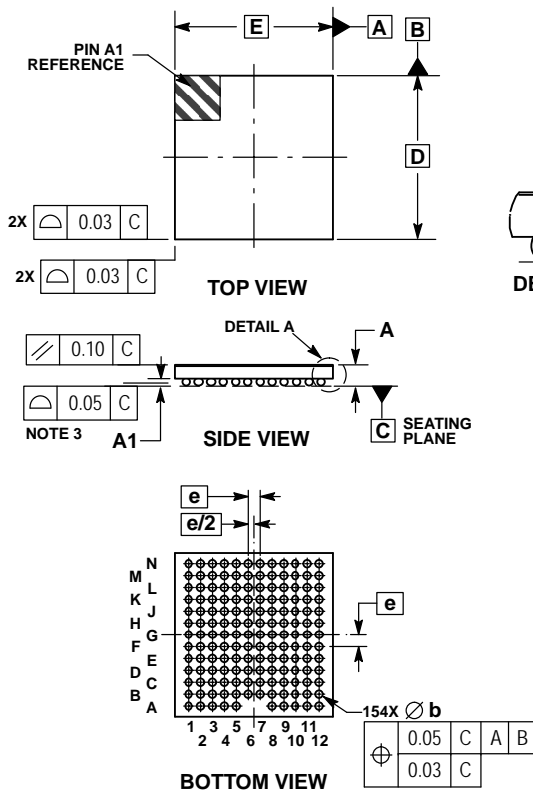

NOTES:

1. DIMENSIONING AND TOLERANCING PER ASME Y14.5M, 1994.
2. CONTROLLING DIMENSION: MILLIMETERS.
3. COPLANARITY APPLIES TO SPHERICAL CROWNS OF THE SOLDER BALLS.

DIM	MILLIMETERS	
	MIN	MAX
A	—	0.73
A1	0.18	0.24
A3	0.04 REF	
b	0.23	0.29
D	5.52 BSC	
E	5.33 BSC	
e	0.40 BSC	

RECOMMENDED SOLDERING FOOTPRINT*

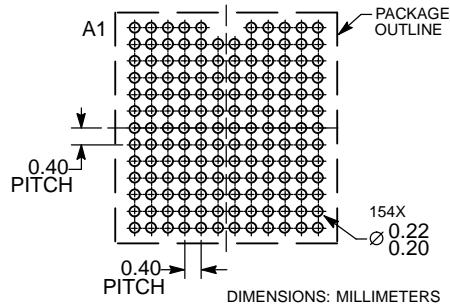

*For additional information on our Pb-Free strategy and soldering details, please download the ON Semiconductor Soldering and Mounting Techniques Reference Manual, SOLDERRM/D.

LC823450

ORDERING INFORMATION

Device	Package	Shipping (Qty / Packing)
LC823450TA-2H	TQFP128 14x14 / TQFP128L (Pb-Free / Halogen Free)	450 / Tray JEDEC
LC823450XATBG	WLCSP154, 5.52x5.33 (Pb-Free / Halogen Free)	1000 / Tape & Reel
LC823450XBTBG	WLCSP154, 5.52x5.33 (Pb-Free / Halogen Free)	1000 / Tape & Reel
LC823450XCTBG	WLCSP154, 5.52x5.33 (Pb-Free / Halogen Free)	1000 / Tape & Reel
LC823450XDTBG	WLCSP154, 5.52x5.33 (Pb-Free / Halogen Free)	1000 / Tape & Reel
LC823450RAH-xx (Under planning)	XBGA240 (Under planning)	Under planning

† For information on tape and reel specifications, including part orientation and tape sizes, please refer to our Tape and Reel Packaging Specifications Brochure, BRD8011/D. http://www.onsemi.com/pub_link/Collateral/BRD8011-D.PDF

ARM, the ARM logo, AMBA, and Cortex are registered trademarks of ARM Limited (or its subsidiaries) in the EU and/or elsewhere.

ON Semiconductor and the ON logo are registered trademarks of Semiconductor Components Industries, LLC (SCILLC) or its subsidiaries in the United States and/or other countries. SCILLC owns the rights to a number of patents, trademarks, copyrights, trade secrets, and other intellectual property. A listing of SCILLC's product/patent coverage may be accessed at www.onsemi.com/site/pdf/Patent-Marking.pdf. SCILLC reserves the right to make changes without further notice to any products herein. SCILLC makes no warranty, representation or guarantee regarding the suitability of its products for any particular purpose, nor does SCILLC assume any liability arising out of the application or use of any product or circuit, and specifically disclaims any and all liability, including without limitation special, consequential or incidental damages. "Typical" parameters which may be provided in SCILLC data sheets and/or specifications can and do vary in different applications and actual performance may vary over time. All operating parameters, including "Typicals" must be validated for each customer application by customer's technical experts. SCILLC does not convey any license under its patent rights nor the rights of others. SCILLC products are not designed, intended, or authorized for use as components in systems intended for surgical implant into the body, or other applications intended to support or sustain life, or for any other application in which the failure of the SCILLC product could create a situation where personal injury or death may occur. Should Buyer purchase or use SCILLC products for any such unintended or unauthorized application, Buyer shall indemnify and hold SCILLC and its officers, employees, subsidiaries, affiliates, and distributors harmless against all claims, costs, damages, and expenses, and reasonable attorney fees arising out of, directly or indirectly, any claim of personal injury or death associated with such unintended or unauthorized use, even if such claim alleges that SCILLC was negligent regarding the design or manufacture of the part. SCILLC is an Equal Opportunity/Affirmative Action Employer. This literature is subject to all applicable copyright laws and is not for resale in any manner.

Mouser Electronics

Authorized Distributor

Click to View Pricing, Inventory, Delivery & Lifecycle Information:

[ON Semiconductor:](#)

[LC823450XCTBG](#) [LC823450XDTBG](#)

Компания «Life Electronics» занимается поставками электронных компонентов импортного и отечественного производства от производителей и со складов крупных дистрибьюторов Европы, Америки и Азии.

С конца 2013 года компания активно расширяет линейку поставок компонентов по направлению коаксиальный кабель, кварцевые генераторы и конденсаторы (керамические, пленочные, электролитические), за счёт заключения дистрибьюторских договоров

Мы предлагаем:

- Конкурентоспособные цены и скидки постоянным клиентам.
- Специальные условия для постоянных клиентов.
- Подбор аналогов.
- Поставку компонентов в любых объемах, удовлетворяющих вашим потребностям.
- Приемлемые сроки поставки, возможна ускоренная поставка.
- Доставку товара в любую точку России и стран СНГ.
- Комплексную поставку.
- Работу по проектам и поставку образцов.
- Формирование склада под заказчика.
- Сертификаты соответствия на поставляемую продукцию (по желанию клиента).
- Тестирование поставляемой продукции.
- Поставку компонентов, требующих военную и космическую приемку.
- Входной контроль качества.
- Наличие сертификата ISO.

В составе нашей компании организован Конструкторский отдел, призванный помогать разработчикам, и инженерам.

Конструкторский отдел помогает осуществить:

- Регистрацию проекта у производителя компонентов.
- Техническую поддержку проекта.
- Защиту от снятия компонента с производства.
- Оценку стоимости проекта по компонентам.
- Изготовление тестовой платы монтаж и пусконаладочные работы.



Тел: +7 (812) 336 43 04 (многоканальный)

Email: org@lifeelectronics.ru