

## Single-Cell Li-Ion/Li-Polymer Battery Charge Management Controller with Input Overvoltage Protection

### Features:

- Complete Linear Charge Management Controller:
  - Integrated Input Overvoltage Protection
  - Integrated Pass Transistor
  - Integrated Current Sense
  - Integrated Reverse Discharge Protection
- Constant Current/Constant Voltage Operation with Thermal Regulation
- 4.15V Undervoltage Lockout (UVLO)
- 18V Absolute Maximum Input with OVP:
  - 6.5V (MCP73113)
  - 5.8V (MCP73114)
- High Accuracy Preset Voltage Regulation Through Full Temperature Range (-5°C to +55°C): ±0.5%
- Battery Charge Voltage Options:
  - 4.10V, 4.20V, 4.35V or 4.4V
- Resistor Programmable Fast Charge Current:
  - 130 mA-1100 mA
- Preconditioning of Deeply Depleted Cells:
  - Available Options: 10% or Disable
- Integrated Precondition Timer:
  - 32 Minutes or Disable
- Automatic End-of-Charge Control:
  - Selectable Minimum Current Ratio: 5%, 7.5%, 10% or 20%
  - Elapse Safety Timer: 4 HR, 6 HR, 8 HR or Disable
- Automatic Recharge:
  - Available Options: 95% or Disable
- Charge Status Output-Two Style Options
- Soft start
- Temperature Range: -40°C to +85°C
- Packaging: DFN-10 (3 mm x 3 mm)

### Applications:

- Low-Cost Li-Ion/Li-Poly Battery Chargers
- MP3 Players
- Digital Still Camera
- Portable Media Players
- Handheld Devices
- Bluetooth® Headsets
- USB Chargers

### Description:

The MCP73113/4 are highly integrated Li-Ion battery charge management controllers for use in space-limited and cost-sensitive applications. The MCP73113/4 devices provide specific charge algorithms for Li-Ion/Li-Polymer batteries to achieve optimal capacity and safety in the shortest charging time possible. Along with their small physical size, the low number of external components make the MCP73113/4 ideally suitable for portable applications. The absolute maximum voltage, up to 18V, allows the use of MCP73113/4 in harsh environments, such as low cost wall wart or voltage spikes from plug/unplug.

The MCP73113/4 devices employ a constant current/constant voltage charge algorithm. The various charging voltage regulations provide design engineers flexibility to use in different applications. The fast charge, constant current value is set with one external resistor from 130 mA to 1100 mA. The MCP73113/4 devices limit the charge current based on die temperature during high power or high ambient conditions. This thermal regulation optimizes the charge cycle time while maintaining device reliability.

The PROG pin of the MCP73113/4 also serves as enable pin. When high-impedance is applied, the MCP73113/4 will be in Standby mode.

The MCP73113/4 devices are fully specified over the ambient temperature range of -40°C to +85°C. They are available in a 10-lead, DFN package.

### Package Types (Top View)



# MCP73113/4

## Typical Application



**TABLE 1: AVAILABLE FACTORY PRESET OPTIONS**

Charge Voltage	OVP	Pre-conditioning Charge Current	Pre-conditioning Threshold	Precondition Timer	Elapse Timer	End-of-Charge Control	Automatic Recharge	Output Status
4.10V	5.8V/6.5V	Disable/10%	66.5%/71.5%	Disable/ 32 Minimum	Disable/4 HR/ 6 HR/8 HR	5%/7.5%/ 10%/20%	No/Yes	Type 1/ Type 2
4.20V	5.8V/6.5V	Disable/10%	66.5%/71.5%	Disable/ 32 Minimum	Disable/4 HR/ 6 HR/8 HR	5%/7.5%/ 10%/20%	No/Yes	Type 1/ Type 2
4.35V	5.8V/6.5V	Disable/10%	66.5%/71.5%	Disable/ 32 Minimum	Disable/4 HR/ 6 HR/8 HR	5%/7.5%/ 10%/20%	No/Yes	Type 1/ Type 2
4.40V	5.8V/6.5V	Disable/10%	66.5%/71.5%	Disable/ 32 Minimum	Disable/4 HR/ 6 HR/8 HR	5%/7.5%/ 10%/20%	No/Yes	Type 1/ Type 2

- Note 1:**  $I_{REG}$ : Regulated fast charge current.  
**2:**  $V_{REG}$ : Regulated charge voltage.  
**3:**  $I_{PREG}/I_{REG}$ : Preconditioning charge current; ratio of regulated fast charge current.  
**4:**  $I_{TERM}/I_{REG}$ : End-of-Charge control; ratio of regulated fast charge current.  
**5:** MCP73113:  $V_{OVP} = 6.5V$ , MCP73114:  $V_{OVP} = 5.8V$ .  
**6:**  $V_{RTH}/V_{REG}$ : Recharge threshold; ratio of regulated battery voltage, 0% or 95%. 0% = Disabled.  
**7:**  $V_{PTH}/V_{REG}$ : Preconditioning threshold voltage.  
**8:** Output Status: Type 1 Fault Output Status = High-Z, Type 2 Fault Output Status = Flashing.

**TABLE 2: STANDARD SAMPLE OPTIONS**

Part Number	$V_{REG}$	OVP	$I_{PREG}/I_{REG}$	Pre-charge Timer	Elapse Timer	$I_{TERM}/I_{REG}$	Auto Recharge Threshold (0%=Disabled)	$V_{PTH}/V_{REG}$	Output Status
MCP73113-16S/MF	4.10V	6.5V	10%	32 Min.	6 HR	10%	95%	71.5%	Type 1
MCP73113-06S/MF	4.20V	6.5V	10%	32 Min.	6 HR	10%	95%	71.5%	Type 1
MCP73114-0NS/MF	4.20V	5.8V	10%	32 Min.	6 HR	10%	95%	71.5%	Type 1

- Note 1:** Customers should contact their distributor, representatives or field application engineer (FAE) for support and sample. Local sales offices are also available to help customers. A listing of sales offices and locations is included in the back of this document. Technical support is available through the web site at: <http://support.microchip.com>.

## Functional Block Diagram

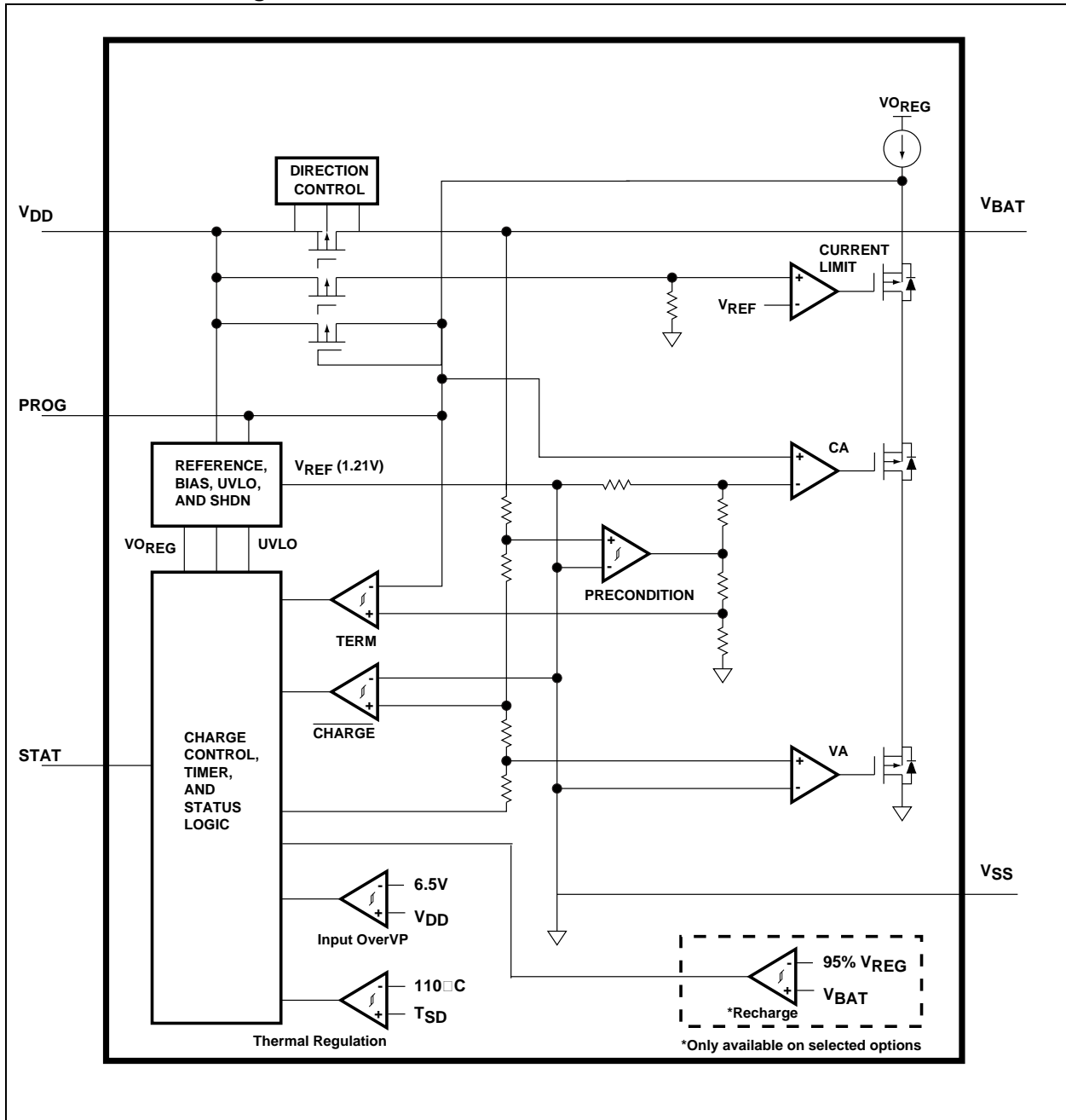

# MCP73113/4

---

NOTES:

## 1.0 ELECTRICAL CHARACTERISTICS

### Absolute Maximum Ratings†

$V_{DD}$ .....	18.0V
$V_{PROG}$ .....	6.0V
All Inputs and Outputs w.r.t. $V_{SS}$ .....	-0.3 to ( $V_{DD}+0.3$ )V
Maximum Junction Temperature, $T_J$ .....	Internally Limited
Storage temperature .....	-65°C to +150°C
ESD protection on all pins	
Human Body Model (1.5 k $\Omega$ in Series with 100 pF).....	$\geq 4$ kV
Machine Model (200 pF, No Series Resistance) .....	300V

† **Notice:** Stresses above those listed under "Maximum Ratings" may cause permanent damage to the device. This is a stress rating only and functional operation of the device at those or any other conditions above those indicated in the operational listings of this specification is not implied. Exposure to maximum rating conditions for extended periods may affect device reliability.

### DC CHARACTERISTICS

Electrical Specifications: Unless otherwise indicated, all limits apply for $V_{DD} = [V_{REG}(\text{Typical}) + 0.3V]$ to 6V, $T_A = -40^\circ\text{C}$ to $+85^\circ\text{C}$ . Typical values are at $+25^\circ\text{C}$ , $V_{DD} = [V_{REG}(\text{Typical}) + 1.0V]$						
Parameters	Sym.	Min.	Typ.	Max.	Units	Conditions
<b>Supply Input</b>						
Input Voltage Range	$V_{DD}$	4	—	16	V	
Operating Supply Voltage	$V_{DD}$	4.2	—	6.5	V	
Supply Current	$I_{SS}$	—	4	5.5	$\mu\text{A}$	Shutdown ( $V_{DD} \leq V_{BAT} - 150 \text{ mV}$ )
		—	700	1500	$\mu\text{A}$	Charging
		—	30	100	$\mu\text{A}$	Standby (PROG Floating)
		—	50	150	$\mu\text{A}$	Charge Complete; No Battery; $V_{DD} < V_{STOP}$
<b>Battery Discharge Current</b>						
Output Reverse Leakage Current	$I_{DISCHARGE}$	—	0.5	2	$\mu\text{A}$	Standby (PROG Floating)
		—	0.5	2	$\mu\text{A}$	Shutdown ( $V_{DD} \leq V_{BAT}$ , or $V_{DD} < V_{STOP}$ )
		—	6	17	$\mu\text{A}$	Charge Complete; $V_{DD}$ is present
<b>Undervoltage Lockout</b>						
UVLO Start Threshold	$V_{START}$	4.10	4.15	4.25	V	
UVLO Stop Threshold	$V_{STOP}$	4.00	4.05	4.15	V	
UVLO Hysteresis	$V_{HYS}$	—	100	—	mV	
<b>Overvoltage Protection</b>						
OVP Start Threshold	$V_{OVP}$	6.4	6.5	6.6	V	MCP73113
		5.8	5.9	6.0	V	MCP73114
OVP Hysteresis	$V_{OVPHYS}$	—	150	—	mV	
<b>Voltage Regulation (Constant-Voltage Mode)</b>						
Regulated Output Voltage Options	$V_{REG}$	4.079	4.10	4.121	V	$T_A = -5^\circ\text{C}$ to $55^\circ\text{C}$ $V_{DD} = [V_{REG}(\text{Typical})+1V]$ $I_{OUT} = 50 \text{ mA}$
		4.179	4.20	4.221	V	
		4.328	4.35	4.372	V	
		4.378	4.40	4.422	V	
Output Voltage Tolerance	$V_{RTOL}$	-0.5	—	0.5	%	
Line Regulation	$ \frac{\Delta V_{BAT}}{V_{BAT}} / \frac{\Delta V_{DD}}{V_{DD}} $	—	0.05	0.20	%/V	$V_{DD} = [V_{REG}(\text{Typical})+1V]$ to 6V $I_{OUT} = 50 \text{ mA}$
Load Regulation	$ \frac{\Delta V_{BAT}}{V_{BAT}} $	—	0.05	0.20	%	$I_{OUT} = 50 \text{ mA} - 150 \text{ mA}$ $V_{DD} = [V_{REG}(\text{Typical})+1V]$
Supply Ripple Attenuation	PSRR	—	-46	—	dB	$I_{OUT} = 20 \text{ mA}$ , 10 Hz to 1 kHz
		—	-30	—	dB	$I_{OUT} = 20 \text{ mA}$ , 10 Hz to 10 kHz

**Note 1:** Not production tested. Ensured by design.

# MCP73113/4

## DC CHARACTERISTICS (CONTINUED)

<b>Electrical Specifications:</b> Unless otherwise indicated, all limits apply for $V_{DD} = [V_{REG}(\text{Typical}) + 0.3V]$ to 6V, $T_A = -40^\circ\text{C}$ to $+85^\circ\text{C}$ . Typical values are at $+25^\circ\text{C}$ , $V_{DD} = [V_{REG}(\text{Typical}) + 1.0V]$						
Parameters	Sym.	Min.	Typ.	Max.	Units	Conditions
<b>Battery Short Protection</b>						
BSP Start Threshold	$V_{SHORT}$	—	1.7	—	V	
BSP Hysteresis	$V_{BSPHYS}$	—	150	—	mV	
BSP Regulation Current	$I_{SHORT}$	—	25	—	mA	
<b>Current Regulation (Fast Charge, Constant-Current Mode)</b>						
Fast Charge Current Regulation	$I_{REG}$	130	—	1100	mA	$T_A = -5^\circ\text{C}$ to $+55^\circ\text{C}$
		—	130	—	mA	PROG = 10 k $\Omega$
		—	1000	—	mA	PROG = 1.1 k $\Omega$
Charge Current Tolerance	$I_{RTOL}$	—	10	—	%	
<b>Preconditioning Current Regulation (Trickle Charge Constant-Current Mode)</b>						
Precondition Current Ratio	$I_{PREG} / I_{REG}$	8	10	15	%	PROG = 1 k $\Omega$ to 10 k $\Omega$ $T_A = -5^\circ\text{C}$ to $+55^\circ\text{C}$
		—	100	—	%	No Preconditioning
Precondition Voltage Threshold Ratio	$V_{PTH} / V_{REG}$	64	66.5	69	%	$V_{BAT}$ Low-to-High
		69	71.5	74	%	
Precondition Hysteresis	$V_{PHYS}$	—	100	—	mV	$V_{BAT}$ High-to-Low (Note 1)
<b>Charge Termination</b>						
Charge Termination Current Ratio	$I_{TERM} / I_{REG}$	3.75	5	6.25	%	PROG = 1 k $\Omega$ to 10 k $\Omega$ $T_A = -5^\circ\text{C}$ to $+55^\circ\text{C}$
		5.6	7.5	9.4	%	
		7.5	10	12.5	%	
		15	20	25	%	
<b>Automatic Recharge</b>						
Recharge Voltage Threshold Ratio	$V_{RTH} / V_{REG}$	93	95.0	97	%	$V_{BAT}$ High-to-Low No Automatic Recharge
		—	0	—	%	
<b>Pass Transistor ON-Resistance</b>						
ON-Resistance	$R_{DSON}$	—	350	—	m $\Omega$	$V_{DD} = 4.5V$ , $T_J = 105^\circ\text{C}$ (Note 1)
<b>Status Indicator – STAT</b>						
Sink Current	$I_{SINK}$	—	20	35	mA	
Low Output Voltage	$V_{OL}$	—	0.2	0.5	V	$I_{SINK} = 4$ mA
Input Leakage Current	$I_{LK}$	—	0.001	1	$\mu\text{A}$	High-Impedance, $V_{DD}$ on pin
<b>PROG Input</b>						
Charge Impedance Range	$R_{PROG}$	1	—	21	k $\Omega$	
Shutdown Impedance	$R_{PROG}$	70	200	—	k $\Omega$	Impedance for Shutdown
PROG Voltage Range	$V_{PROG}$	0	—	5	V	
<b>Automatic Power Down</b>						
Automatic Power Down Entry Threshold	$V_{PDENTRY}$	$V_{BAT} + 10$ mV	$V_{BAT} + 50$ mV	—	V	$2.3V \leq V_{BAT} \leq V_{REG}$ $V_{DD}$ Falling
Automatic Power Down Exit Threshold	$V_{PDEXIT}$	—	$V_{BAT} + 150$ mV	$V_{BAT} + 250$ mV	V	$2.3V \leq V_{BAT} \leq V_{REG}$ $V_{DD}$ Rising
<b>Thermal Shutdown</b>						
Die Temperature	$T_{SD}$	—	150	—	$^\circ\text{C}$	
Die Temperature Hysteresis	$T_{SDHYS}$	—	10	—	$^\circ\text{C}$	

**Note 1:** Not production tested. Ensured by design.

## AC CHARACTERISTICS

**Electrical Specifications:** Unless otherwise specified, all limits apply for  $V_{DD} = [V_{REG}(\text{Typical}) + 0.3V]$  to 6V,  $T_A = -40^\circ\text{C}$  to  $+85^\circ\text{C}$ . Typical values are at  $+25^\circ\text{C}$ ,  $V_{DD} = [V_{REG}(\text{Typical}) + 1.0V]$

Parameters	Sym.	Min.	Typ.	Max.	Units	Conditions
<b>Elapsed Timer</b>						
Elapsed Timer Period	$t_{ELAPSED}$	—	0	—	Hours	Timer Disabled
		3.6	4.0	4.4	Hours	
		5.4	6.0	6.6	Hours	
		7.2	8.0	8.8	Hours	
<b>Preconditioning Timer</b>						
Preconditioning Timer Period	$t_{PRECHG}$	—	0	—	Hours	Disabled Timer
		0.4	0.5	0.6	Hours	
<b>Status Indicator</b>						
Status Output turn-off delay	$t_{OFF}$	—	—	500	$\mu\text{s}$	$I_{SINK} = 1 \text{ mA to } 0 \text{ mA}$ (Note 1)
Status Output turn-on delay	$t_{ON}$	—	—	500	$\mu\text{s}$	$I_{SINK} = 0 \text{ mA to } 1 \text{ mA}$ (Note 1)

**Note 1:** Not production tested. Ensured by design.

## TEMPERATURE SPECIFICATIONS

**Electrical Specifications:** Unless otherwise indicated, all limits apply for  $V_{DD} = [V_{REG}(\text{Typical}) + 0.3V]$  to 6V. Typical values are at  $+25^\circ\text{C}$ ,  $V_{DD} = [V_{REG}(\text{Typical}) + 1.0V]$

Parameters	Sym.	Min.	Typ.	Max.	Units	Conditions
<b>Temperature Ranges</b>						
Specified Temperature Range	$T_A$	-40	—	+85	$^\circ\text{C}$	
Operating Temperature Range	$T_J$	-40	—	+125	$^\circ\text{C}$	
Storage Temperature Range	$T_A$	-65	—	+150	$^\circ\text{C}$	
<b>Thermal Package Resistances</b>						
Thermal Resistance, DFN-10 (3x3)	$\theta_{JA}$	—	64	—	$^\circ\text{C/W}$	4-Layer JC51-7 Standard Board, Natural Convection
	$\theta_{JC}$	—	12	—	$^\circ\text{C/W}$	

# MCP73113/4

---

NOTES:



## 2.0 TYPICAL PERFORMANCE CURVES

**Note:** The graphs and tables provided following this note are a statistical summary based on a limited number of samples and are provided for informational purposes only. The performance characteristics listed herein are not tested or guaranteed. In some graphs or tables, the data presented may be outside the specified operating range (e.g., outside specified power supply range) and therefore outside the warranted range.

**Note:** Unless otherwise indicated,  $V_{DD} = [V_{REG}(Typical) + 1V]$ ,  $I_{OUT} = 50\text{ mA}$  and  $T_A = +25^\circ\text{C}$ , Constant-Voltage mode.

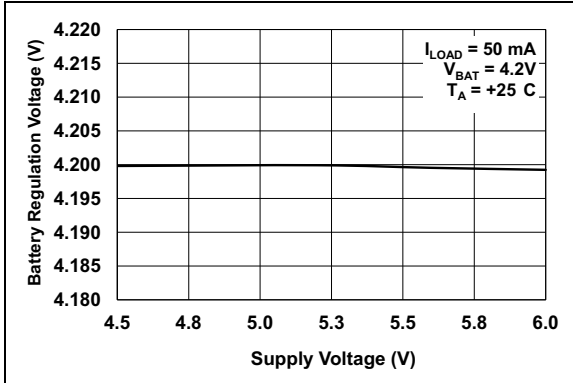

**FIGURE 2-1:** Battery Regulation Voltage ( $V_{BAT}$ ) vs. Supply Voltage ( $V_{DD}$ ).

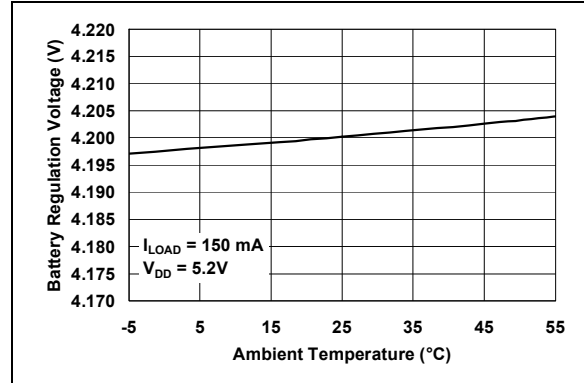

**FIGURE 2-4:** Battery Regulation Voltage ( $V_{BAT}$ ) vs. Ambient Temperature ( $T_A$ ).

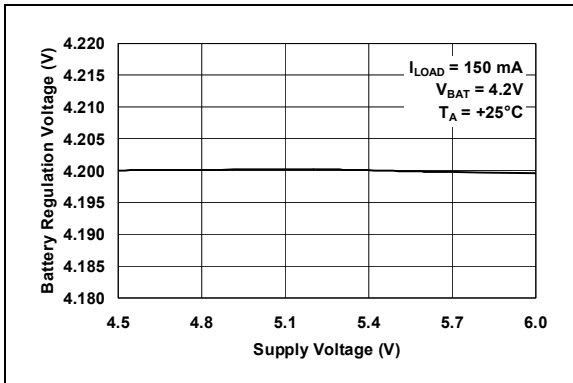

**FIGURE 2-2:** Battery Regulation Voltage ( $V_{BAT}$ ) vs. Supply Voltage ( $V_{DD}$ ).

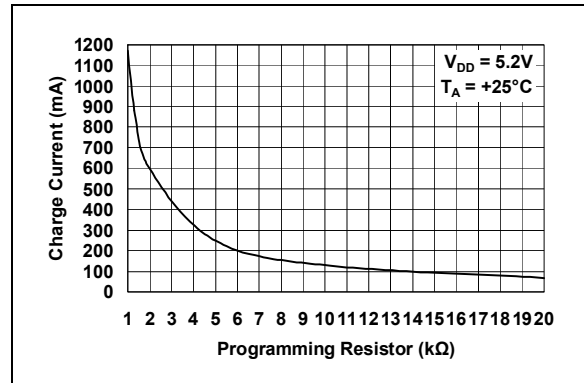

**FIGURE 2-5:** Charge Current ( $I_{OUT}$ ) vs. Programming Resistor ( $R_{PROG}$ ).

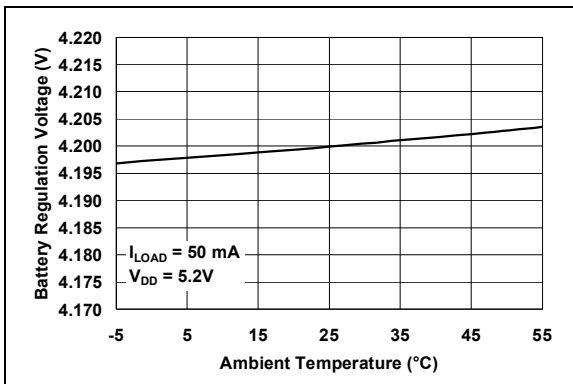

**FIGURE 2-3:** Battery Regulation Voltage ( $V_{BAT}$ ) vs. Ambient Temperature ( $T_A$ ).

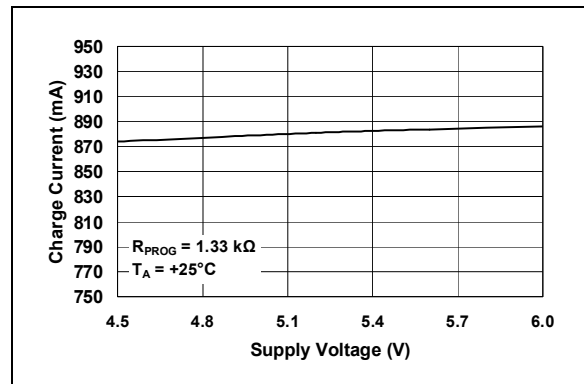
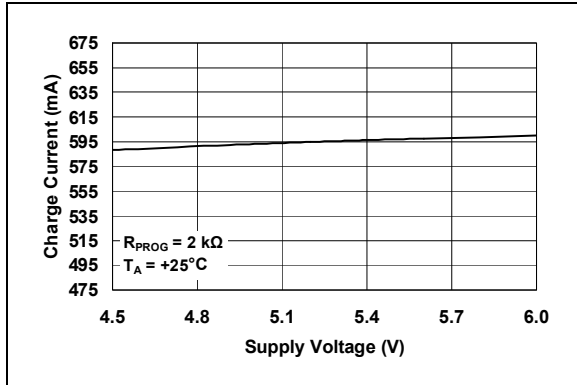

**FIGURE 2-6:** Charge Current ( $I_{OUT}$ ) vs. Supply Voltage ( $V_{DD}$ ).

# MCP73113/4

## TYPICAL PERFORMANCE CURVES (CONTINUED)

Note: Unless otherwise indicated,  $V_{DD} = [V_{REG}(Typical) + 1V]$ ,  $I_{OUT} = 10\text{ mA}$  and  $T_A = +25^\circ\text{C}$ , Constant-Voltage mode.



**FIGURE 2-7:** Charge Current ( $I_{OUT}$ ) vs. Programming Resistor ( $R_{PROG}$ ).

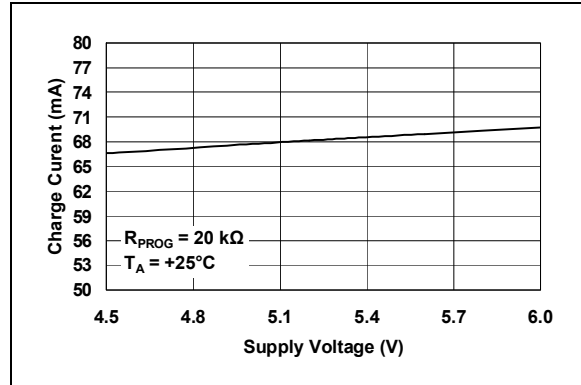

**FIGURE 2-10:** Charge Current ( $I_{OUT}$ ) vs. Programming Resistor ( $R_{PROG}$ ).



**FIGURE 2-8:** Charge Current ( $I_{OUT}$ ) vs. Programming Resistor ( $R_{PROG}$ ).

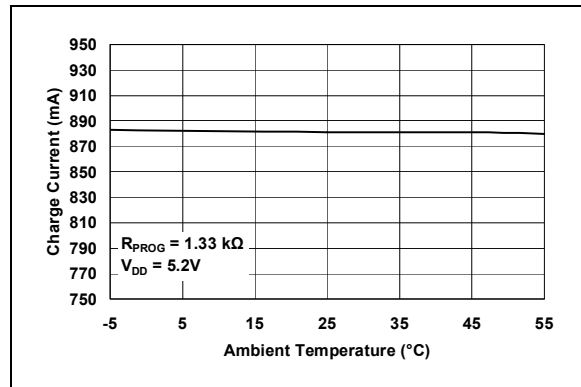

**FIGURE 2-11:** Charge Current ( $I_{OUT}$ ) vs. Ambient Temperature ( $T_A$ ).

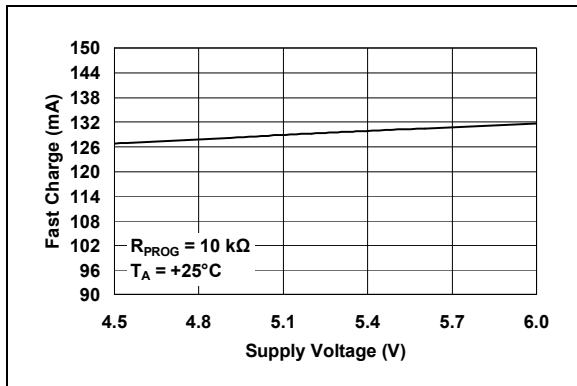

**FIGURE 2-9:** Charge Current ( $I_{OUT}$ ) vs. Programming Resistor ( $R_{PROG}$ ).

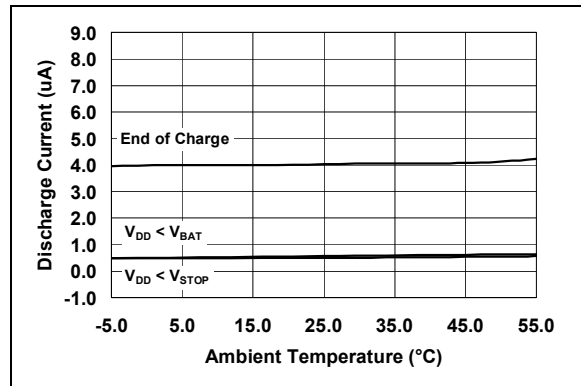

**FIGURE 2-12:** Output Leakage Current ( $I_{DISCHARGE}$ ) vs. Ambient Temperature ( $T_A$ ).

## TYPICAL PERFORMANCE CURVES (CONTINUED)

**Note:** Unless otherwise indicated,  $V_{DD} = [V_{REG}(Typical) + 1V]$ ,  $I_{OUT} = 10\text{ mA}$  and  $T_A = +25^\circ\text{C}$ , Constant-Voltage mode.



**FIGURE 2-13:** Overvoltage Protection Start (50 ms/Div).



**FIGURE 2-16:** Complete Charge Cycle (875 mAh Li-Ion Battery).



**FIGURE 2-14:** Overvoltage Protection Stop (50 ms/Div).



**FIGURE 2-17:** Line Transient Response ( $I_{LOAD} = 10\text{ mA}$ , Output: 1.0V/Div, Source: 2.0V/Div).



**FIGURE 2-15:** Load Transient Response ( $I_{LOAD} = 50\text{ mA}$ , Output: 100 mV/Div, Time: 100  $\mu\text{s}$ /Div).



**FIGURE 2-18:** Line Transient Response ( $I_{LOAD} = 100\text{ mA}$ , Output: 1.0V/Div, Source: 2.0V/Div).

# MCP73113/4

---

NOTES:

### 3.0 PIN DESCRIPTION

The descriptions of the pins are listed in [Table 3-1](#).

**TABLE 3-1: PIN FUNCTION TABLES**

MCP73113/4	Symbol	I/O	Function
DFN-10			
1, 2	V <sub>DD</sub>	I	Battery Management Input Supply
3, 4	V <sub>BAT</sub>	I/O	Battery Charge Control Output
5, 6	NC	—	No Connection
7	STAT	O	Battery Charge Status Output
8, 9	V <sub>SS</sub>	—	Battery Management 0V Reference
10	PROG	I/O	Battery Charge Current Regulation Program and Charge Control Enable
11	EP	—	Exposed Pad

#### 3.1 Battery Management Input Supply (V<sub>DD</sub>)

A supply voltage of [V<sub>REG</sub> (Typical) + 0.3V] to 6.0V is recommended. Bypass to V<sub>SS</sub> with a minimum of 1  $\mu$ F. The V<sub>DD</sub> pin is rated 18V absolute maximum to prevent sudden rise of input voltage from spikes or low-cost AC-DC wall adapter.

#### 3.2 Battery Charge Control Output (V<sub>BAT</sub>)

Connect to the positive terminal of the battery. Bypass to V<sub>SS</sub> with a minimum of 1  $\mu$ F to ensure loop stability when the battery is disconnected.

#### 3.3 No Connect (NC)

No connect.

#### 3.4 Battery Management 0V Reference (V<sub>SS</sub>)

Connect to the negative terminal of the battery and input supply.

#### 3.5 Status Output (STAT)

STAT is an open-drain logic output for connection to an LED for charge status indication in stand-alone applications. Alternatively, a pull-up resistor can be applied for interfacing to a host microcontroller. Refer to [Table 5-2](#) for a summary of the status output during a charge cycle.

#### 3.6 Current Regulation Set (PROG)

The fast charge current is set by placing a resistor from PROG to V<sub>SS</sub> during Constant-Current (CC) mode. PROG pin is rated up to 5V with 6V absolute maximum value.

The PROG pin also serves as a charge control enable pin. Allowing the PROG pin to float or connecting the pin to an impedance greater than 200 k $\Omega$  will disable the MCP73113/4 charger. Refer to [Section 5.5 “Constant Current MODE – Fast Charge”](#) for details.

#### 3.7 Exposed Pad (EP)

The Exposed Thermal Pad (EP) should be connected to the exposed copper area on the Printed Circuit Board (PCB) to enhance thermal power dissipation. Additional vias on the copper area under the MCP73113/4 device will improve the performance of heat dissipation and simplify the assembly process.

# MCP73113/4

---

NOTES:

## 4.0 DEVICE OVERVIEW

The MCP73113/4 are simple, but fully integrated linear charge management controllers. Figure 4-1 depicts the operational flow algorithm.



FIGURE 4-1: The MCP73113/4 Flowchart.

# MCP73113/4

---

NOTES:



## 5.0 DETAILED DESCRIPTION

### 5.1 Undervoltage Lockout (UVLO)

An internal undervoltage lockout (UVLO) circuit monitors the input voltage and keeps the charger in Shutdown mode until the input supply rises above the UVLO threshold. In the event a battery is present when the input power is applied, the input supply must rise approximately 150 mV above the battery voltage before the MCP73113/4 device becomes operational.

The UVLO circuit places the device in Shutdown mode if the input supply falls to approximately 150 mV above the battery voltage. The UVLO circuit is always active. At any time, the input supply is below the UVLO threshold or approximately 150 mV of the voltage at the  $V_{BAT}$  pin, the MCP73113/4 device is placed in a Shutdown mode.

### 5.2 Overvoltage Protection (OVP)

An internal overvoltage protection (OVP) circuit monitors the input voltage and keeps the charger in Shutdown mode when the input supply rises above the OVP threshold. The hysteresis of OVP is approximately 150 mV for the MCP73113/4 device.

The MCP73113/4 device is operational between UVLO and OVP threshold. The OVP circuit is also recognized as overvoltage lockout (OVLO).

### 5.3 Charge Qualification

When the input power is applied, the input supply must rise 150 mV above the battery voltage before the MCP73113/4 becomes operational.

The automatic power-down circuit places the device in a Shutdown mode if the input supply falls to within +50 mV of the battery voltage.

The automatic circuit is always active. At any time the input supply is within +50 mV of the voltage at the  $V_{BAT}$  pin, the MCP73113/4 is placed in a Shutdown mode.

For a charge cycle to begin, the automatic power-down conditions must be met and the charge enable input must be above the input high threshold.

#### 5.3.1 BATTERY MANAGEMENT INPUT SUPPLY ( $V_{DD}$ )

The  $V_{DD}$  input is the input supply to the MCP73113/4. The MCP73113/4 automatically enters a Power-Down mode if the voltage on the  $V_{DD}$  input falls to within +50 mV of the battery voltage. This feature prevents draining the battery pack when the  $V_{DD}$  supply is not present.

#### 5.3.2 BATTERY CHARGE CONTROL OUTPUT ( $V_{BAT}$ )

The battery charge control output is the drain terminal of an internal P-channel MOSFET. The MCP73113/4 devices provide constant current and voltage regulation to the battery pack by controlling this MOSFET in the linear region. The battery charge control output should be connected to the positive terminal of the battery pack.

#### 5.3.3 BATTERY DETECTION

The MCP73113/4 detects the battery presence by monitoring the voltage at  $V_{BAT}$ . The charge flow will initiate when the voltage on  $V_{BAT}$  is below the  $V_{RECHARGE}$  threshold. Refer to **Section 1.0 “Electrical Characteristics”** for  $V_{RECHARGE}$  values. The value will be the same for the non-rechargeable device.

When  $V_{BAT} > V_{REG} + \text{Hysteresis}$ , the charge will be suspended or not started, depending on the current charge status, to prevent overcharging.

### 5.4 Preconditioning

If the voltage at the  $V_{BAT}$  pin is less than the preconditioning threshold, the MCP73113/4 device enters a Preconditioning mode. The preconditioning threshold is factory set. Refer to **Section 1.0 “Electrical Characteristics”** for preconditioning threshold options.

In this mode, the MCP73113/4 device supplies 10% of the fast charge current (established with the value of the resistor connected to the PROG pin) to the battery.

When the voltage at the  $V_{BAT}$  pin rises above the preconditioning threshold, the MCP73113/4 device enters the constant current (Fast Charge) mode.

**Note:** The MCP73113/4 also offer options with no preconditioning.

#### 5.4.1 TIMER EXPIRED DURING PRECONDITIONING MODE

If the internal timer expires before the voltage threshold is reached for Fast Charge mode, a timer fault is indicated and the charge cycle terminates. The MCP73113/4 device remains in this condition until the battery is removed or input power is cycled. If the battery is removed, the MCP73113/4 device enters the Standby mode where it remains until a battery is reinserted.

**Note:** The typical preconditioning timer for MCP73113/4 is 32 minutes. The MCP73113/4 also offer options with no preconditioning timer.

# MCP73113/4

## 5.5 Constant Current MODE – Fast Charge

During the Constant-Current mode, the programmed charge current is supplied to the battery or load.

The charge current is established using a single resistor from PROG to V<sub>SS</sub>. The program resistor and the charge current are calculated using the following equations:

### EQUATION 5-1:

$$I_{REG} = 1104 \times R^{-0.93}$$

Where:

R<sub>PROG</sub> = kilo-ohms (kΩ)  
 I<sub>REG</sub> = milliamperes (mA)

### EQUATION 5-2:

$$R_{PROG} = 10^{\frac{(\log(I_{REG})/(-0.93)) \log(1104)}{1}}$$

Where:

R<sub>PROG</sub> = kilo-ohms (kΩ)  
 I<sub>REG</sub> = milliamperes (mA)

Table 5-1 provides commonly seen E96 (1%) and E24 (5%) resistors for various charge current to reduce design time.

TABLE 5-1: RESISTOR LOOK-UP TABLE

Charge Current (mA)	Recommended E96 Resistor (Ω)	Recommended E24 Resistor (Ω)
130	10k	10k
150	8.45k	8.20k
200	6.20k	6.20k
250	4.99k	5.10k
300	4.02k	3.90k
350	3.40k	3.30k
400	3.00k	3.00k
450	2.61k	2.70k
500	2.32k	2.37k
550	2.10k	2.20k
600	1.91k	2.00k
650	1.78k	1.80k
700	1.62k	1.60k
750	1.50k	1.50k
800	1.40k	1.50k
850	1.33k	1.30k
900	1.24k	1.20k
950	1.18k	1.20k
1000	1.10k	1.10k
1100	1.00k	1.00k

Constant-Current mode is maintained until the voltage at the V<sub>BAT</sub> pin reaches the regulation voltage, V<sub>REG</sub>. When Constant-Current mode is invoked, the internal timer is reset.

### 5.5.1 TIMER EXPIRED DURING CONSTANT CURRENT – FAST CHARGE MODE

If the internal timer expires before the recharge voltage threshold is reached, a timer fault is indicated and the charge cycle terminates. The MCP73113/4 device remains in this condition until the battery is removed. If the battery is removed or input power is cycled, the MCP73113/4 device enters the Standby mode where it remains until a battery is reinserted.

## 5.6 Constant-Voltage Mode

When the voltage at the V<sub>BAT</sub> pin reaches the regulation voltage, V<sub>REG</sub>, constant voltage regulation begins. The regulation voltage is factory set to 4.10V, 4.20V, 4.35V or 4.40V with a tolerance of ±0.5%.

## 5.7 Charge Termination

The charge cycle is terminated when, during Constant-Voltage mode, the average charge current diminishes below a threshold established with the value of 5%, 7.5%, 10% or 20% of fast charge current or internal timer has expired. A 1 ms filter time on the termination comparator ensures that transient load conditions do not result in premature charge cycle termination. The timer period is factory set and can be disabled. Refer to Section 1.0 “Electrical Characteristics” for timer period options.

## 5.8 Automatic Recharge

The MCP73113/4 device continuously monitors the voltage at the V<sub>BAT</sub> pin in the Charge Complete mode. If the voltage drops below the recharge threshold, another charge cycle begins and current is once again supplied to the battery or load. The recharge threshold is factory set. Refer to Section 1.0 “Electrical Characteristics” for recharge threshold options.

**Note:** The MCP73113/4 also offer options with no automatic recharge.

For the MCP73113/4 devices with no recharge option, the MCP73113/4 will go into Standby mode when termination condition is met. The charge will not restart until at least one of the following conditions have been met:

- Battery is removed from the system and inserted again
- V<sub>DD</sub> is removed and plugged in again
- R<sub>PROG</sub> is disconnected (or high-impedance) and reconnected

## 5.9 Thermal Regulation

The MCP73113/4 shall limit the charge current based on the die temperature. The thermal regulation optimizes the charge cycle time while maintaining device reliability. Figure 5-1 depicts the thermal regulation for the MCP73113/4 device. Refer to Section 1.0 “Electrical Characteristics” for thermal package resistances and Section 6.1.1.2 “Thermal Considerations” for calculating power dissipation.



**FIGURE 5-1:** Charge Current ( $I_{OUT}$ ) vs. Junction Temperature ( $T_J$ ).

## 5.10 Thermal Shutdown

The MCP73113/4 suspends charge if the die temperature exceeds +150°C. Charging will resume when the die temperature has cooled by approximately 10°C. The thermal shutdown is a secondary safety feature in the event that there is a failure within the thermal regulation circuitry.

## 5.11 Status Indicator

The charge status outputs are open-drain outputs with two different states: Low (L), and High-Impedance (high-Z). The charge status outputs can be used to illuminate LEDs. Optionally, the charge status outputs can be used as an interface to a host microcontroller. Table 5-2 summarizes the state of the status outputs during a charge cycle.

**TABLE 5-2: STATUS OUTPUTS**

CHARGE CYCLE STATE	STAT
Shutdown	high-Z
Standby	high-Z
Preconditioning	L
Constant Current Fast Charge	L
Constant Voltage	L
Charge Complete - Standby	high-Z
Temperature Fault	1.6 second 50% D.C. Flashing (Type2) high-Z (Type 1)
Timer Fault	1.6 second 50% D.C. Flashing (Type 2) high-Z (Type 1)
Preconditioning Timer Fault	1.6 second 50% D.C. Flashing (Type 2) high-Z (Type 1)

## 5.12 Battery Short Circuit Protection

When a single-cell Li-Ion battery is detected, an internal battery short circuit protection (BSP) circuit starts monitoring the battery voltage. When  $V_{BAT}$  is below the typical 1.7V battery short circuit protection threshold voltage, the charging behavior is postponed. A 25 mA (typical) detection current is supplied for recovering from the battery short circuit condition.

Preconditioning mode resumes when  $V_{BAT}$  raises above the battery short circuit protection threshold. The battery voltage must rise approximately 150 mV above the battery short circuit protection voltage before the MCP73113/4 device becomes operational.

# MCP73113/4

---

NOTES:

## 6.0 APPLICATIONS

The MCP73113/4 devices are designed to operate with a host microcontroller or in stand-alone applications. The MCP73113/4 provides the preferred charge algorithm for Lithium-Ion and Lithium-Polymer cells Constant-current followed by Constant-voltage.

Figure 6-1 depicts a typical stand-alone application circuit, while Figure 6-2 depicts the accompanying charge profile.

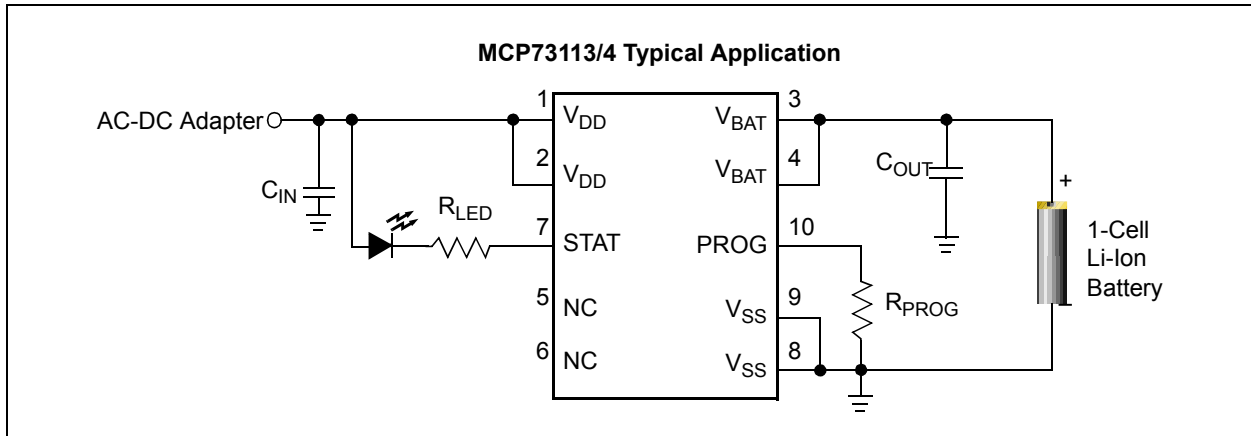

**FIGURE 6-1:** Typical Application Circuit.

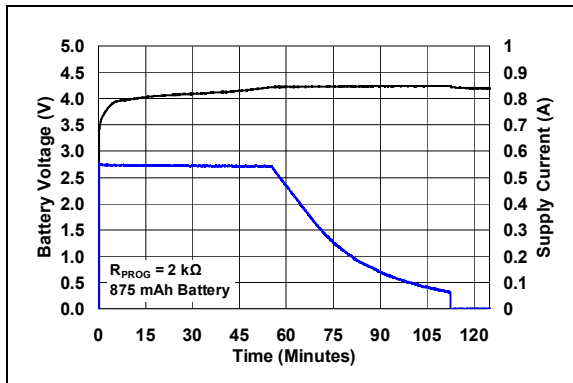

**FIGURE 6-2:** Typical Charge Profile (875 mAh Battery).

## 6.1 Application Circuit Design

Due to the low efficiency of linear charging, the most important factors are thermal design and cost, which are a direct function of the input voltage, output current and thermal impedance between the battery charger and the ambient cooling air. The worst-case situation is when the device has transitioned from the Preconditioning mode to the Constant-Current mode. In this situation, the battery charger has to dissipate the maximum power. A trade-off must be made between the charge current, cost and thermal requirements of the charger.

### 6.1.1 COMPONENT SELECTION

Selection of the external components in Figure 6-1 is crucial to the integrity and reliability of the charging system. The following discussion is intended as a guide for the component selection process.

#### 6.1.1.1 Charge Current

The preferred fast charge current for Li-Ion/Li-Poly cells is below the 1C rate, with an absolute maximum current at the 2C rate. **The recommended fast charge current should be obtained from the battery manufacturer.** For example, a 500 mAh battery pack with 0.7C preferred fast charge current has a charge current of 350 mA. Charging at this rate provides the shortest charge cycle times without degradation to the battery pack performance or life.

**Note:** Please consult with your battery supplier or refer to the battery data sheet for preferred charge rate.

# MCP73113/4

## 6.1.1.2 Thermal Considerations

The worst-case power dissipation in the battery charger occurs when the input voltage is at the maximum and the device has transitioned from the Preconditioning mode to the Constant-Current mode. In this case, the power dissipation is:

$$PowerDissipation = (V_{DDMAX} - V_{PTHMIN}) \times I_{REGMAX}$$

Where:

- $V_{DDMAX}$  = the maximum input voltage
- $I_{REGMAX}$  = the maximum fast charge current
- $V_{PTHMIN}$  = the minimum transition threshold voltage

Power dissipation with a 5V,  $\pm 10\%$  input voltage source, 500 mA  $\pm 10\%$  and preconditioning threshold voltage at 2.7V is:

### EQUATION 6-1:

$$PowerDissipation = (5.5V - 2.7V) \times 550mA = 1.54W$$

This power dissipation with the battery charger in the DFN-10 package will result approximately 63°C above room temperature.

## 6.1.1.3 External Capacitors

The MCP73113/4 are stable with or without a battery load. In order to maintain good AC stability in the Constant-Voltage mode, a minimum capacitance of 1  $\mu$ F is recommended to bypass the  $V_{BAT}$  pin to  $V_{SS}$ . This capacitance provides compensation when there is no battery load. In addition, the battery and interconnections appear inductive at high frequencies. These elements are in the control feedback loop during Constant-Voltage mode. Therefore, the bypass capacitance may be necessary to compensate for the inductive nature of the battery pack.

A minimum of 1  $\mu$ F, is recommended for both the output capacitor and the input capacitor for typical applications.

**TABLE 6-1: MLCC CAPACITOR EXAMPLE**

MLCC Capacitors	Temperature Range	Tolerance
X7R	-55°C to +125°C	$\pm 15\%$
X5R	-55°C to +85°C	$\pm 15\%$

Virtually any good quality output filter capacitor can be used, independent of the capacitor's minimum Effective Series Resistance (ESR) value. The actual value of the capacitor (and its associated ESR) depends on the output load current. A 1  $\mu$ F ceramic, tantalum or aluminum electrolytic capacitor at the output is usually sufficient to ensure stability.

## 6.1.1.4 Reverse-Blocking Protection

The MCP73113/4 provide protection from a faulted or shorted input. Without the protection, a faulted or shorted input would discharge the battery pack through the body diode of the internal pass transistor.

## 6.2 PCB Layout Issues

For optimum voltage regulation, place the battery pack as close as possible to the device's  $V_{BAT}$  and  $V_{SS}$  pins, recommended to minimize voltage drops along the high current-carrying PCB traces.

If the PCB layout is used as a heat sink, adding many vias in the heat sink pad can help conduct more heat to the backplane of the PCB, thus reducing the maximum junction temperature. Figure 6-4 and Figure 6-5 depict a typical layout with PCB heat sinking.

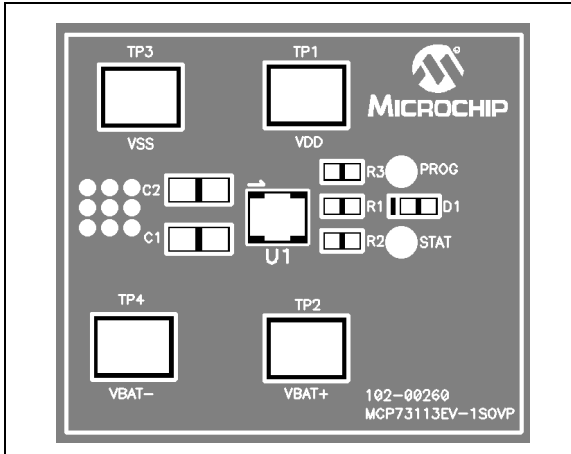

**FIGURE 6-3:** Typical Layout (Top).

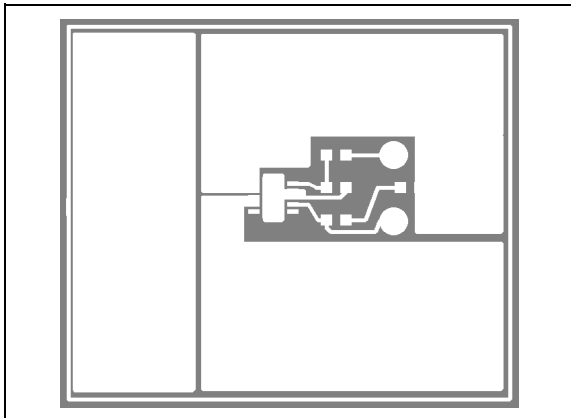

**FIGURE 6-4:** Typical Layout (Top Metal).



**FIGURE 6-5:** Typical Layout (Bottom).

# MCP73113/4

---

NOTES:



## 7.0 PACKAGING INFORMATION

### 7.1 Package Marking Information

10-Lead DFN (3x3)

XXXX
YYWW
NNN

Standard *	
Part Number	Code
MCP73113-06SI/MF	93HI
MCP73113-16SI/MF	83HI
MCP73114-0NSI/MF	9MHI

Example:

93HI
1229
256

**Legend:** XX...X Customer-specific information  
 Y Year code (last digit of calendar year)  
 YY Year code (last 2 digits of calendar year)  
 WW Week code (week of January 1 is week '01')  
 NNN Alphanumeric traceability code  
 ⓔ3 Pb-free JEDEC designator for Matte Tin (Sn)  
 \* This package is Pb-free. The Pb-free JEDEC designator ⓔ3 can be found on the outer packaging for this package.

**Note:** In the event the full Microchip part number cannot be marked on one line, it will be carried over to the next line, thus limiting the number of available characters for customer-specific information.

# MCP73113/4

## 10-Lead Plastic Dual Flat, No Lead Package (MF) - 3x3x0.9mm Body [DFN]

**Note:** For the most current package drawings, please see the Microchip Packaging Specification located at <http://www.microchip.com/packaging>



Microchip Technology Drawing No. C04-063C Sheet 1 of 2

## 10-Lead Plastic Dual Flat, No Lead Package (MF) - 3x3x0.9mm Body [DFN]

**Note:** For the most current package drawings, please see the Microchip Packaging Specification located at <http://www.microchip.com/packaging>



Dimension Limits	Units	MILLIMETERS		
		MIN	NOM	MAX
Number of Pins	N	10		
Pitch	e	0.50 BSC		
Overall Height	A	0.80	0.90	1.00
Standoff	A1	0.00	0.02	0.05
Contact Thickness	A3	0.20 REF		
Overall Length	D	3.00 BSC		
Exposed Pad Length	D2	2.15	2.35	2.45
Overall Width	E	3.00 BSC		
Exposed Pad Width	E2	1.40	1.50	1.75
Contact Width	b	0.18	0.25	0.30
Contact Length	L	0.30	0.40	0.50
Contact-to-Exposed Pad	K	0.20	-	-

**Notes:**

1. Pin 1 visual index feature may vary, but must be located within the hatched area.
2. Package may have one or more exposed tie bars at ends.
3. Package is saw singulated.
4. Dimensioning and tolerancing per ASME Y14.5M.  
 BSC: Basic Dimension. Theoretically exact value shown without tolerances.  
 REF: Reference Dimension, usually without tolerance, for information purposes only.

Microchip Technology Drawing No. C04-063C Sheet 2 of 2

# MCP73113/4

## 10-Lead Plastic Dual Flat, No Lead Package (MF) - 3x3x0.9mm Body [DFN]

**Note:** For the most current package drawings, please see the Microchip Packaging Specification located at <http://www.microchip.com/packaging>

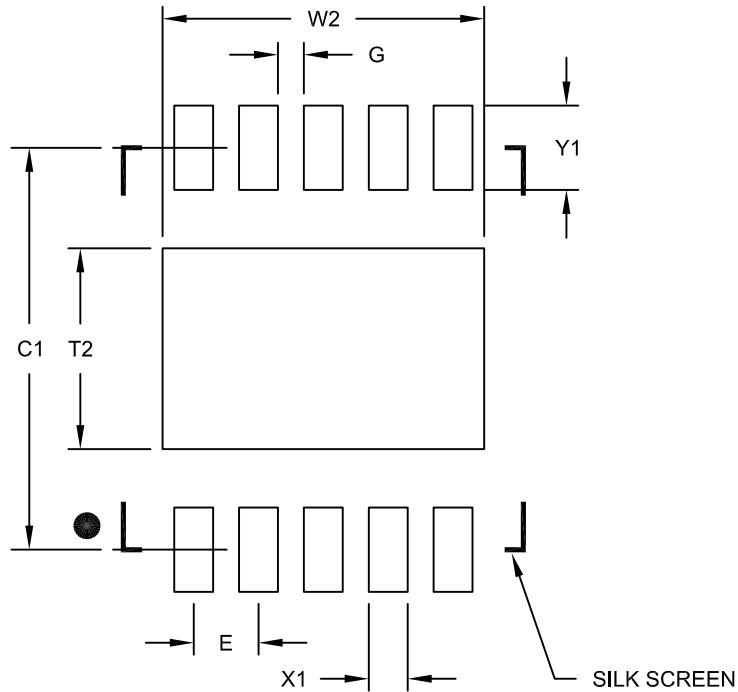

RECOMMENDED LAND PATTERN

		Units	MILLIMETERS		
Dimension Limits			MIN	NOM	MAX
Contact Pitch	E		0.50 BSC		
Optional Center Pad Width	W2				2.48
Optional Center Pad Length	T2				1.55
Contact Pad Spacing	C1			3.10	
Contact Pad Width (X10)	X1				0.30
Contact Pad Length (X10)	Y1				0.65
Distance Between Pads	G	0.20			

**Notes:**

1. Dimensioning and tolerancing per ASME Y14.5M

BSC: Basic Dimension. Theoretically exact value shown without tolerances.

Microchip Technology Drawing No. C04-2063B

## APPENDIX A: REVISION HISTORY

### Revision D (February 2013)

The following is the list of modifications:

1. Updated the Functional Block Diagram.
2. Updated the DC Characteristics table.
3. Updated the Temperature Specifications table.
4. Updated **Section 3.6 “Current Regulation Set (PROG)”**.
5. Updated **Section 3.7 “Exposed Pad (EP)”**.
6. Updated **Section 5.3.3 “Battery Detection”**.
7. Updated [Equation 5-2](#).
8. Updated **Section 5.12 “Battery Short Circuit Protection”**.
9. Updated **Section 6.1.1.3 “External Capacitors”**.

### Revision C (January 2010)

The following is the list of modifications:

1. **DC Characteristics table:** Removed the minimum and maximum values for the BSP Start Threshold parameter.

### Revision B (July 2009)

The following is the list of modifications:

1. Added MCP73114 device throughout the document.
2. Updated specifications for the MCP73113/4 device family throughout the document.
3. Updated package marking information.
4. Updated Product Identification System page.

### Revision A (May 2009)

- Original Release of this Document.

# MCP73113/4

---

NOTES:

## PRODUCT IDENTIFICATION SYSTEM

To order or obtain information, e.g., on pricing or delivery, refer to the factory or the listed sales office.

<u>PART NO.</u>	<u>X</u>	<u>XX</u>
Device	Temperature Range	Package
<p><b>Device:</b></p> <p>MCP73113: Single Cell Li-Ion/Li-Polymer Battery Device  MCP73113T: Single Cell Li-Ion/Li-Polymer Battery Device, Tape and Reel</p> <p>MCP73114: Single Cell Li-Ion/Li-Polymer Battery Device  MCP73114T: Single Cell Li-Ion/Li-Polymer Battery Device, Tape and Reel</p> <p><b>Temperature Range:</b></p> <p>I = -40°C to +85°C (Industrial)</p> <p><b>Package:</b></p> <p>MF = Plastic Dual Flat No Lead, 3x3 mm Body (DFN), 10-Lead</p>		<p><b>Examples:</b></p> <p>a) MCP73113-06SI/MF: Single Cell Li-Ion/Li-Polymer Battery Device</p> <p>b) MCP73113-16SI/MF: Single Cell Li-Ion/Li-Polymer Battery Device</p> <p>c) MCP73113T-06SI-MF: Tape and Reel, Single Cell Li-Ion/Li-Polymer Battery Device</p> <p>d) MCP73113T-16SI/MF: Tape and Reel, Single Cell Li-Ion/Li-Polymer Battery Device</p> <p>a) MCP73114-0NSI/MF: Single Cell Li-Ion/Li-Polymer Battery Device</p> <p>b) MCP73114T-0NSI/MF: Tape and Reel, Single Cell Li-Ion/Li-Polymer Battery Device</p>

# MCP73113/4

---

NOTES:



---

---

**Note the following details of the code protection feature on Microchip devices:**

- Microchip products meet the specification contained in their particular Microchip Data Sheet.
- Microchip believes that its family of products is one of the most secure families of its kind on the market today, when used in the intended manner and under normal conditions.
- There are dishonest and possibly illegal methods used to breach the code protection feature. All of these methods, to our knowledge, require using the Microchip products in a manner outside the operating specifications contained in Microchip's Data Sheets. Most likely, the person doing so is engaged in theft of intellectual property.
- Microchip is willing to work with the customer who is concerned about the integrity of their code.
- Neither Microchip nor any other semiconductor manufacturer can guarantee the security of their code. Code protection does not mean that we are guaranteeing the product as “unbreakable.”

Code protection is constantly evolving. We at Microchip are committed to continuously improving the code protection features of our products. Attempts to break Microchip's code protection feature may be a violation of the Digital Millennium Copyright Act. If such acts allow unauthorized access to your software or other copyrighted work, you may have a right to sue for relief under that Act.

---

Information contained in this publication regarding device applications and the like is provided only for your convenience and may be superseded by updates. It is your responsibility to ensure that your application meets with your specifications. MICROCHIP MAKES NO REPRESENTATIONS OR WARRANTIES OF ANY KIND WHETHER EXPRESS OR IMPLIED, WRITTEN OR ORAL, STATUTORY OR OTHERWISE, RELATED TO THE INFORMATION, INCLUDING BUT NOT LIMITED TO ITS CONDITION, QUALITY, PERFORMANCE, MERCHANTABILITY OR FITNESS FOR PURPOSE. Microchip disclaims all liability arising from this information and its use. Use of Microchip devices in life support and/or safety applications is entirely at the buyer's risk, and the buyer agrees to defend, indemnify and hold harmless Microchip from any and all damages, claims, suits, or expenses resulting from such use. No licenses are conveyed, implicitly or otherwise, under any Microchip intellectual property rights.

#### **Trademarks**

The Microchip name and logo, the Microchip logo, dsPIC, FlashFlex, KEELOQ, KEELOQ logo, MPLAB, PIC, PICmicro, PICSTART, PIC<sup>32</sup> logo, rPIC, SST, SST Logo, SuperFlash and UNI/O are registered trademarks of Microchip Technology Incorporated in the U.S.A. and other countries.

FilterLab, Hampshire, HI-TECH C, Linear Active Thermistor, MTP, SEEVAL and The Embedded Control Solutions Company are registered trademarks of Microchip Technology Incorporated in the U.S.A.

Silicon Storage Technology is a registered trademark of Microchip Technology Inc. in other countries.

Analog-for-the-Digital Age, Application Maestro, BodyCom, chipKIT, chipKIT logo, CodeGuard, dsPICDEM, dsPICDEM.net, dsPICworks, dsSPEAK, ECAN, ECONOMONITOR, FanSense, HI-TIDE, In-Circuit Serial Programming, ICSP, Mindi, MiWi, MPASM, MPF, MPLAB Certified logo, MPLIB, MPLINK, mTouch, Omniclient Code Generation, PICC, PICC-18, PICDEM, PICDEM.net, PICkit, PICTail, REAL ICE, rLAB, Select Mode, SQI, Serial Quad I/O, Total Endurance, TSHARC, UniWinDriver, WiperLock, ZENA and Z-Scale are trademarks of Microchip Technology Incorporated in the U.S.A. and other countries.

SQTP is a service mark of Microchip Technology Incorporated in the U.S.A.

GestIC and ULPP are registered trademarks of Microchip Technology Germany II GmbH & Co. & KG, a subsidiary of Microchip Technology Inc., in other countries.

All other trademarks mentioned herein are property of their respective companies.

© 2009-2013, Microchip Technology Incorporated, Printed in the U.S.A., All Rights Reserved.

 Printed on recycled paper.

ISBN: 9781620769959

**QUALITY MANAGEMENT SYSTEM**  
**CERTIFIED BY DNV**  
**== ISO/TS 16949 ==**

*Microchip received ISO/TS-16949:2009 certification for its worldwide headquarters, design and wafer fabrication facilities in Chandler and Tempe, Arizona; Gresham, Oregon and design centers in California and India. The Company's quality system processes and procedures are for its PIC<sup>®</sup> MCUs and dsPIC<sup>®</sup> DSCs, KEELOQ<sup>®</sup> code hopping devices, Serial EEPROMs, microperipherals, nonvolatile memory and analog products. In addition, Microchip's quality system for the design and manufacture of development systems is ISO 9001:2000 certified.*



# MICROCHIP

## Worldwide Sales and Service

### AMERICAS

**Corporate Office**  
2355 West Chandler Blvd.  
Chandler, AZ 85224-6199  
Tel: 480-792-7200  
Fax: 480-792-7277  
Technical Support:  
<http://www.microchip.com/support>  
Web Address:  
[www.microchip.com](http://www.microchip.com)

**Atlanta**  
Duluth, GA  
Tel: 678-957-9614  
Fax: 678-957-1455

**Boston**  
Westborough, MA  
Tel: 774-760-0087  
Fax: 774-760-0088

**Chicago**  
Itasca, IL  
Tel: 630-285-0071  
Fax: 630-285-0075

**Cleveland**  
Independence, OH  
Tel: 216-447-0464  
Fax: 216-447-0643

**Dallas**  
Addison, TX  
Tel: 972-818-7423  
Fax: 972-818-2924

**Detroit**  
Farmington Hills, MI  
Tel: 248-538-2250  
Fax: 248-538-2260

**Indianapolis**  
Noblesville, IN  
Tel: 317-773-8323  
Fax: 317-773-5453

**Los Angeles**  
Mission Viejo, CA  
Tel: 949-462-9523  
Fax: 949-462-9608

**Santa Clara**  
Santa Clara, CA  
Tel: 408-961-6444  
Fax: 408-961-6445

**Toronto**  
Mississauga, Ontario,  
Canada  
Tel: 905-673-0699  
Fax: 905-673-6509

### ASIA/PACIFIC

**Asia Pacific Office**  
Suites 3707-14, 37th Floor  
Tower 6, The Gateway  
Harbour City, Kowloon  
Hong Kong  
Tel: 852-2401-1200  
Fax: 852-2401-3431

**Australia - Sydney**  
Tel: 61-2-9868-6733  
Fax: 61-2-9868-6755

**China - Beijing**  
Tel: 86-10-8569-7000  
Fax: 86-10-8528-2104

**China - Chengdu**  
Tel: 86-28-8665-5511  
Fax: 86-28-8665-7889

**China - Chongqing**  
Tel: 86-23-8980-9588  
Fax: 86-23-8980-9500

**China - Hangzhou**  
Tel: 86-571-2819-3187  
Fax: 86-571-2819-3189

**China - Hong Kong SAR**  
Tel: 852-2943-5100  
Fax: 852-2401-3431

**China - Nanjing**  
Tel: 86-25-8473-2460  
Fax: 86-25-8473-2470

**China - Qingdao**  
Tel: 86-532-8502-7355  
Fax: 86-532-8502-7205

**China - Shanghai**  
Tel: 86-21-5407-5533  
Fax: 86-21-5407-5066

**China - Shenyang**  
Tel: 86-24-2334-2829  
Fax: 86-24-2334-2393

**China - Shenzhen**  
Tel: 86-755-8864-2200  
Fax: 86-755-8203-1760

**China - Wuhan**  
Tel: 86-27-5980-5300  
Fax: 86-27-5980-5118

**China - Xian**  
Tel: 86-29-8833-7252  
Fax: 86-29-8833-7256

**China - Xiamen**  
Tel: 86-592-2388138  
Fax: 86-592-2388130

**China - Zhuhai**  
Tel: 86-756-3210040  
Fax: 86-756-3210049

### ASIA/PACIFIC

**India - Bangalore**  
Tel: 91-80-3090-4444  
Fax: 91-80-3090-4123

**India - New Delhi**  
Tel: 91-11-4160-8631  
Fax: 91-11-4160-8632

**India - Pune**  
Tel: 91-20-2566-1512  
Fax: 91-20-2566-1513

**Japan - Osaka**  
Tel: 81-6-6152-7160  
Fax: 81-6-6152-9310

**Japan - Tokyo**  
Tel: 81-3-6880-3770  
Fax: 81-3-6880-3771

**Korea - Daegu**  
Tel: 82-53-744-4301  
Fax: 82-53-744-4302

**Korea - Seoul**  
Tel: 82-2-554-7200  
Fax: 82-2-558-5932 or  
82-2-558-5934

**Malaysia - Kuala Lumpur**  
Tel: 60-3-6201-9857  
Fax: 60-3-6201-9859

**Malaysia - Penang**  
Tel: 60-4-227-8870  
Fax: 60-4-227-4068

**Philippines - Manila**  
Tel: 63-2-634-9065  
Fax: 63-2-634-9069

**Singapore**  
Tel: 65-6334-8870  
Fax: 65-6334-8850

**Taiwan - Hsin Chu**  
Tel: 886-3-5778-366  
Fax: 886-3-5770-955

**Taiwan - Kaohsiung**  
Tel: 886-7-213-7828  
Fax: 886-7-330-9305

**Taiwan - Taipei**  
Tel: 886-2-2508-8600  
Fax: 886-2-2508-0102

**Thailand - Bangkok**  
Tel: 66-2-694-1351  
Fax: 66-2-694-1350

### EUROPE

**Austria - Wels**  
Tel: 43-7242-2244-39  
Fax: 43-7242-2244-393

**Denmark - Copenhagen**  
Tel: 45-4450-2828  
Fax: 45-4485-2829

**France - Paris**  
Tel: 33-1-69-53-63-20  
Fax: 33-1-69-30-90-79

**Germany - Munich**  
Tel: 49-89-627-144-0  
Fax: 49-89-627-144-44

**Italy - Milan**  
Tel: 39-0331-742611  
Fax: 39-0331-466781

**Netherlands - Drunen**  
Tel: 31-416-690399  
Fax: 31-416-690340

**Spain - Madrid**  
Tel: 34-91-708-08-90  
Fax: 34-91-708-08-91

**UK - Wokingham**  
Tel: 44-118-921-5869  
Fax: 44-118-921-5820

11/29/12

Компания «Life Electronics» занимается поставками электронных компонентов импортного и отечественного производства от производителей и со складов крупных дистрибьюторов Европы, Америки и Азии.

С конца 2013 года компания активно расширяет линейку поставок компонентов по направлению коаксиальный кабель, кварцевые генераторы и конденсаторы (керамические, пленочные, электролитические), за счёт заключения дистрибьюторских договоров

Мы предлагаем:

- Конкурентоспособные цены и скидки постоянным клиентам.
- Специальные условия для постоянных клиентов.
- Подбор аналогов.
- Поставку компонентов в любых объемах, удовлетворяющих вашим потребностям.
- Приемлемые сроки поставки, возможна ускоренная поставка.
- Доставку товара в любую точку России и стран СНГ.
- Комплексную поставку.
- Работу по проектам и поставку образцов.
- Формирование склада под заказчика.
- Сертификаты соответствия на поставляемую продукцию (по желанию клиента).
- Тестирование поставляемой продукции.
- Поставку компонентов, требующих военную и космическую приемку.
- Входной контроль качества.
- Наличие сертификата ISO.

В составе нашей компании организован Конструкторский отдел, призванный помогать разработчикам, и инженерам.

Конструкторский отдел помогает осуществить:

- Регистрацию проекта у производителя компонентов.
- Техническую поддержку проекта.
- Защиту от снятия компонента с производства.
- Оценку стоимости проекта по компонентам.
- Изготовление тестовой платы монтаж и пусконаладочные работы.



Тел: +7 (812) 336 43 04 (многоканальный)

Email: [org@lifeelectronics.ru](mailto:org@lifeelectronics.ru)