

**SMPTE COMPATIBLE
HDTV CONNECTION SYSTEM
3K.93C SERIES**



LEMO pioneered and set the standard for HDTV

The global standard for HDTV fibre connector

LEMO developed the 3K.93C Series connectors in the early stages of the introduction of HDTV, becoming the standard for high-definition TV. It is one of the only connectors being used worldwide that complies fully with SMPTE, ARIB and EBU standards for both signal and cable. LEMO's 3K.93C connectors are the standard in national and international broadcast companies.



Fast transition to HDTV

Transition to HDTV is easier than ever with LEMO. The wide range of shell styles and termination procedures, for even non-fibre experts, makes it possible for everyone to be successful in HDTV. The LEMO 3K.93C connector uses two single-mode fibre contacts, two high voltage contacts, and two signal contacts. Cable drums and cable assemblies with standard lengths are available off the shelf.



Over 20'000 stainless steel shells mating cycles offered

The rugged stainless steel outer shell of the LEMO 3K.93C connectors ensures a very long product life, when properly cleaned. The fibre optic contact can will last many years.

Simple maintenance

The optical contacts are accessible for fast cleaning; an optional simple, lightweight and portable fibre inspection unit helps the user view the condition of the fibre optic contact to ensure reliable operation.

Benefits

- Quick disconnect Push-Pull self latching system
- Over 11 shells to meet various application needs
- Stainless steel shell for rugged and harsh environment
- Optional pre-terminated F2 contacts for simple and rapid field assembly
- UL certified connectors
- ARIB (BTA S-1005B), ANSI/SMPTE (304 M-1998 and 311M-1998) and EBU (R100-1999) compatible

Outside Broadcast Van Configuration

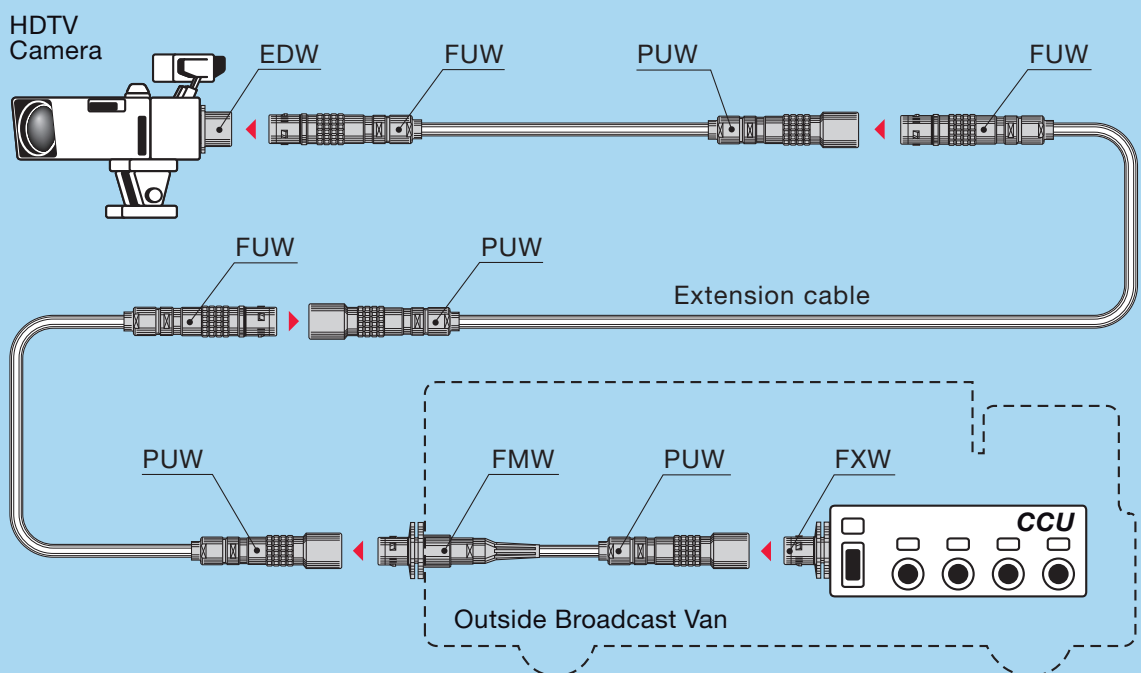

Highest performance with LEMO standard F2 fibre contact

The advantage of using epoxy and polish contacts is the reliability of the termination and longevity of the connector to assure a quality signal transmission. These contacts are very robust and can withstand wide outdoor temperature variations.

Extend the quality of your connection

LEMO offers quality assembly service for HDTV connection systems. The connector assembly is done in-house by qualified personnel.

NEW pre-terminated F2 fibre optic contacts - offering a quick and easy field solution

The new pre-terminated contact provides the user with a contact that can be terminated without the use of epoxy, or polishing. It is intended for use in situations where it is critical that a cable be repaired quickly. They may be used indoors, in fixed installation environments, or in the field. Designed for use with the LEMO 3K.93C, this contact fits directly into any LEMO connector where the standard F2 contact is used.

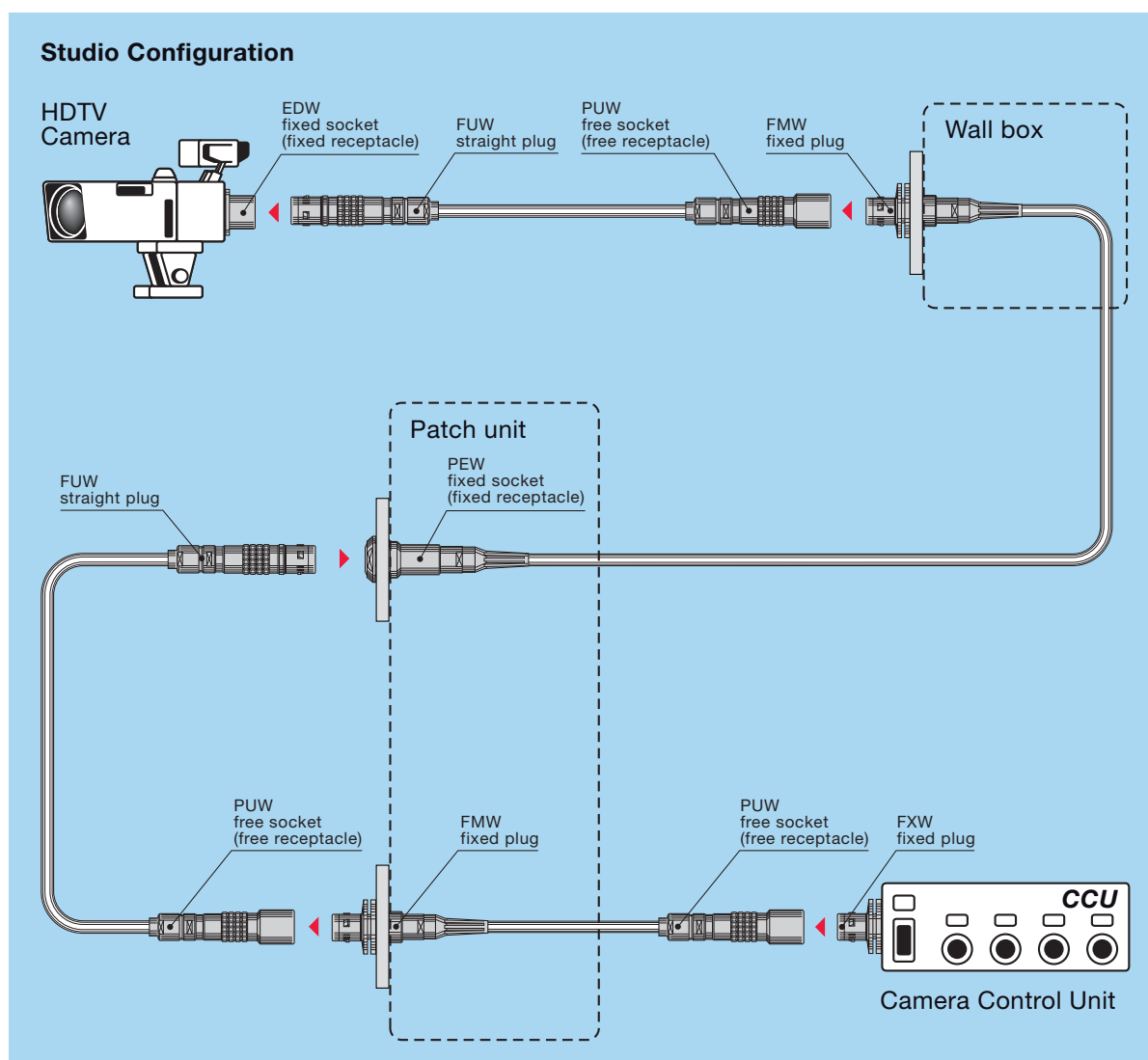

3K.93C Series

General characteristics

Cable retention force	> 700 N
Endurance: Brass+Cr	> 10000 cycles
Endurance: Stainless steel	20000 cycles
Drop test	2 m
Shock	100 g, 10-50 ms
Vibration	7 cycles (20-2000Hz)
Standard F2 temperature range	-40° C, +80° C
Pre-terminated F2 temperature range	-20° C, +60° C
Humidity	up to 95% at 60° C
Water resistance	Depth of 1.8 m for 48 hours
Corrosion	48 hours, 5% salt water test
Index protection	IP 68

Electrical contacts

Number of contacts Male contact ø Contact type Conductor AWG min. Conductor AWG max. Working Voltage max. Test Voltage Rated current Contact resistance	Power	Signal
	2 1.3 mm crimp 18 14 ≤ 600 V rms 2250 V rms 10 A < 4 mΩ	2 0.9 mm crimp 24 20 ≤ 42 V rms 1000 V rms 3 A < 5 mΩ
Shell to shell conductivity Insulation resistance	< 5 mΩ > 10 ⁹ Ω	

Fibre optic contacts

Characteristics	Value	Standard
Number of contacts	2	
Fibre core/cladding ø	single mode 9/125 µm	
Ferrule bore inside ø	125 µm ²⁾	
Mean insertion loss	0.10 dB ¹⁾	IEC 61300-3-4
Return loss (machine polishing)	< -45 dB	IEC 61300-3-6

Note: ¹⁾ tested at 1300 nm in accordance with IEC 61300-03-04 method B.
²⁾ other ferrule bore ø available (126 µm).

Recommended SMPTE/ARIB cables

Cable group	Type	Utilisation	Sheath ø
2	2SM-9.2-37.5	Standard	9.2 ± 0.3
3	2SM-12-15	Long distances	12.0 ± 0.4
4 ¹⁾	2SM-16-37.5	Studio	16.0 ± 0.5

Note: ¹⁾ The outer sheath shall be removed for assembly.

Models

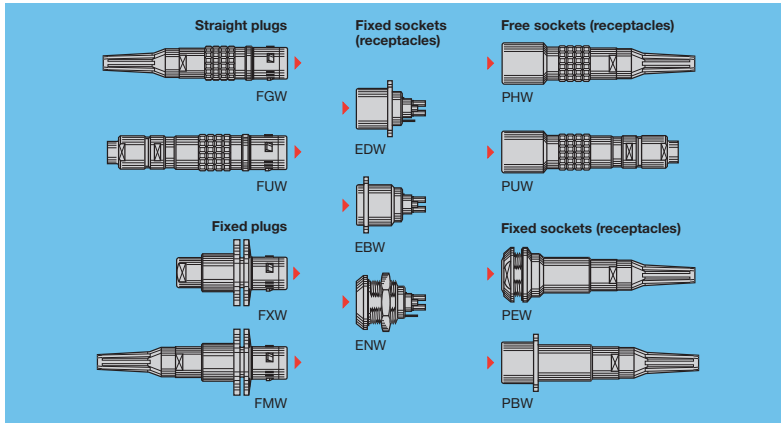

Mixed contact type

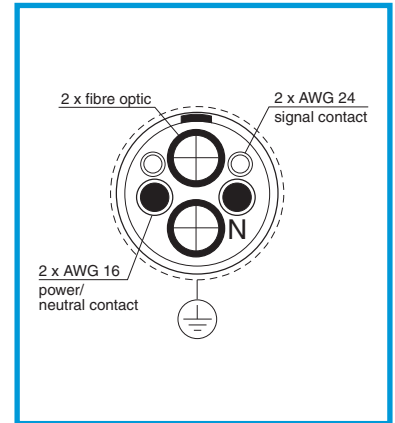

FGW Straight plug, cable adapter, with bend relief

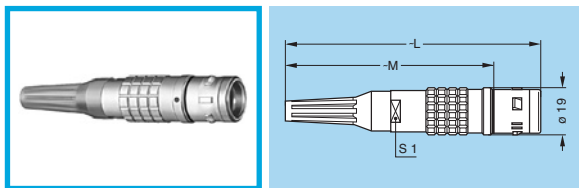

Part Number	Cable group	Dim. (mm)			Cable ø		Housing material
		L	M	S1	Max	Min	
FGW.3K.93C.CLMT96Z	2-4	101	81	15	9.5	8.9	Chr.-plat.
FGW.3K.93C.CLMT12Z	3	135	115	20	12.5	11.6	brass

Note: The bend relief must be ordered separately (see page 8).
Two female fibre optic contacts PSS.F2.BA2.LCT10 must be ordered separately.

FUW Straight plug, cable collet adapter and long shell for fitting a bend relief with cap

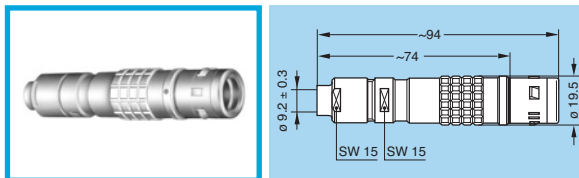

Part Number	Cable group	Cable ø		Housing material
		Max	Min	
FUW.3K.93C.TLMC96	2-4	9.5	8.9	Stainless steel
FUW.3K.93C.TLMC12	3	12.5	11.6	

Note: The bend relief with cap GMF.3K.085.EANZ must be ordered separately (see page 8).
Two female fibre optic contacts PSS.F2.BA2.LCT10 must be ordered separately.

FXW Fixed plug with round flange (4 holes mounting), without collet

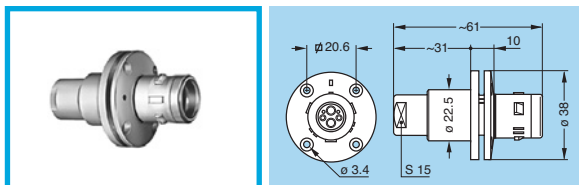

Part Number	Housing material
FXW.3K.93C.TLM	Stainless steel

Note: Two female fibre optic contacts PSS.F2.BA2.LCE30 must be ordered separately.

Note: all dimensions are in millimetre.

FMW Fixed plug with round flange (4 holes mounting), cable adapter, with bend relief

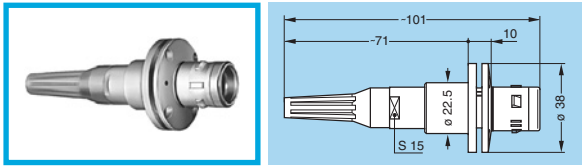

Part Number	Cable group	Cable ϕ		Collet type	Housing material
		Max	Min		
FMW.3K.93C.TLMC96Z	2-4	9.5	8.9	C	Stainless steel
FMW.3K.93C.TLMT96Z	2-4	9.5	8.9	T	

Note: The bend relief must be ordered separately (see page 8).
2 female fibre optic contacts PSS.F2.BA2.LCT10 must be ordered separately.

EDW Fixed socket (receptacle) with rear square flange (4 holes mounting), and earthing tag

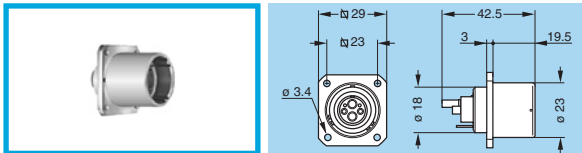

Part Number	Housing material
EDW.3K.93C.TLC	Stainless steel

Note: 2 male fibre optic contacts FFS.F2.BA2.LCE30 must be ordered separately.

EBW Fixed socket (receptacle) with front square flange (4 holes mounting)

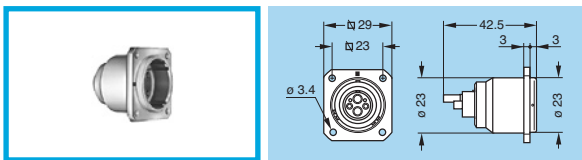

Part Number	Housing material
EBW.3K.93C.TLC	Stainless steel

Note: 2 male fibre optic contacts FFS.F2.BA2.LCE30 must be ordered separately.

ENW Fixed socket (receptacle), nut fixing, and earthing tag

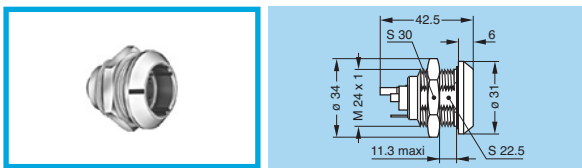

Part Number	Housing material
ENW.3K.93C.TLC	Stainless steel

Note: 2 male fibre optic contacts FFS.F2.BA2.LCE30 must be ordered separately.

PHW Free socket (receptacle), cable adapter, with bend relief

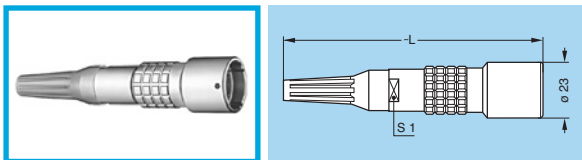

Part Number	Cable group	Dim. (mm)		Câble ϕ		Housing material
		L	S1	Max	Min	
PHW.3K.93C.CLCT96Z	2-4	105	15	9.5	8.9	Chrome-plat. brass
PHW.3K.93C.CLCT12Z	3	139	20	12.5	11.6	

Note: The bend relief must be ordered separately (see page 8).
2 male fibre optic contacts FFS.F2.BA2.LCT10 must be ordered separately.

PUW Free socket (receptacle), cable collet adapter and long shell for fitting a bend relief with cap

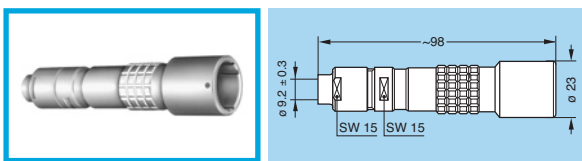

Part Number	Cable group	Cable ϕ		Housing material
		Max	Min	
PUW.3K.93C.TLCC96	2-4	9.5	8.9	Stainless steel
PUW.3K.93C.TLCC12	3	12.5	11.6	

Note: The bend relief with cap GMP.3K.085.EANZ must be ordered separately (see p. 8).
2 male fibre optic contacts FFS.F2.BA2.LCT10 must be ordered separately.

PEW Fixed socket (receptacle), nut fixing, cable adapter, with bend relief (back panel mounting)

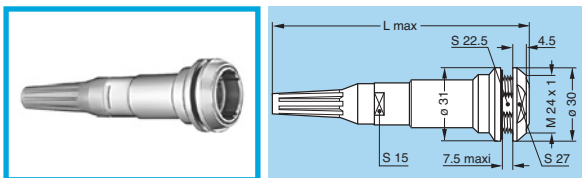

Part Number	Cable group	L max (mm)	Cable ϕ		Collet type	Housing material
			Max	Min		
PEW.3K.93C.TLCC96Z	2-4	136	9.5	8.9	C	Stainless steel
PEW.3K.93C.TLCT96Z	2-4	105	9.5	8.9	T	

Note: The bend relief must be ordered separately (see page 8).
2 male fibre optic contacts FFS.F2.BA2.LCT10 must be ordered separately.
Recommended «C» collet type with enhanced «EMC» protection.

PBW Fixed socket (receptacle) with rear square flange (4 holes mounting), cable adapter, with bend relief

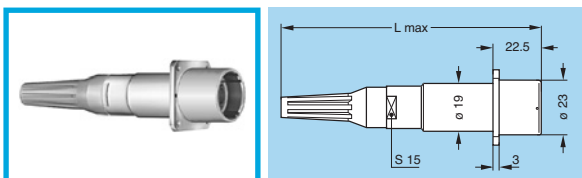

Part Number	Cable group	L max (mm)	Cable ϕ		Collet type	Housing material
			Max	Min		
PBW.3K.93C.TLCC96Z	2-4	136	9.5	8.9	C	Stainless steel
PBW.3K.93C.TLCT96Z	2-4	105	9.5	8.9	T	

Note: The bend relief must be ordered separately (see page 8).
2 male fibre optic contacts FFS.F2.BA2.LCT10 must be ordered separately.
Recommended «C» collet type with enhanced «EMC» protection.

F2 fibre optic contacts

The standard F2 fibre contact is the highest performing solution on the market regarding thermal stability and very low signal loss. The F2 pre-terminated fibre optic contact was designed as repair

solution but may also be used for indoor fixed installations. These pre-terminated contacts enable simple and rapid on-site-terminations. The design eliminates the need to polish fibre

optic elements as well as preparing and using special epoxies for the fibre assembly.

Optical characteristics

Characteristics	Contact model	Value	Standard
Average insertion loss fibre 9/125 µm Return loss fibre 9/125 µm (UPC)	FFS, PSS (standard F2) FFS, PSS (standard F2)	0.10 dB ≥ 45 dB	IEC 61300-03-04 IEC 61300-03-06
Average insertion loss fibre 9/125 µm Return loss fibre 9/125 µm (UPC)	FFT, PST (pre-terminated F2) FFT, PST (pre-terminated F2)	0.5 dB ≥ 45 dB	IEC 61300-03-04 IEC 61300-03-06

FFS.F2 Standard F2 male fibre optic contact

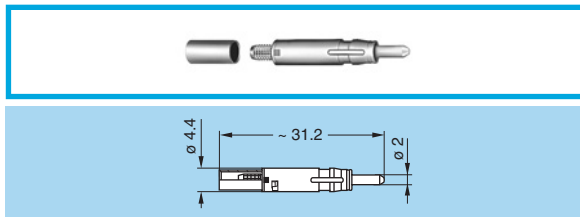

Part Number	For connector models	Cable structure	Cable ø
FFS.F2.BA2.LCT10	PHW, PEW, PBW, PUW	Buffer coated fibre	0.25 to 1.1
FFS.F2.BA2.LCE30	EDW, ENW, EBW	Tight jacket cable	1.7 to 3.0

Note: The above contacts are fitted with a 125 µm bore ferrule

PSS.F2 Standard F2 female fibre optic contact

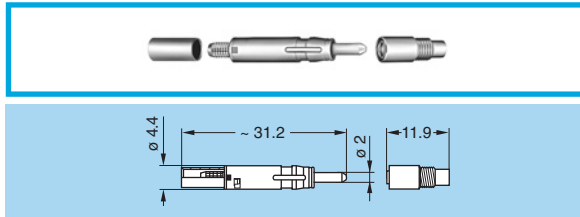

Part Number	For connector models	Cable structure	Cable ø
PSS.F2.BA2.LCT10	FGW, FMW, FUW	Buffer coated fibre	0.25 to 1.1
PSS.F2.BA2.LCE30	FXW	Tight jacket cable	1.7 to 3.0

Note: The above contacts are fitted with a 125 µm bore ferrule

FFT.F2 Pre-terminated F2 male fibre optic contact

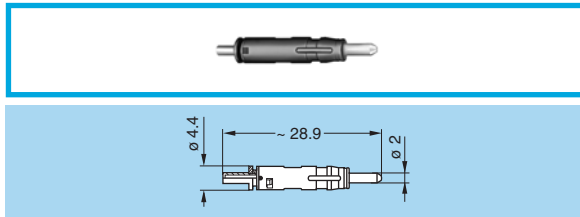

Part Number	For connector models	Cable structure	Cable ø
FFT.F2.BA2.LCE10	PHW, PEW, PBW, PUW	Buffer coated fibre	0.25 to 1.1

PST.F2 Pre-terminated F2 female fibre optic contact

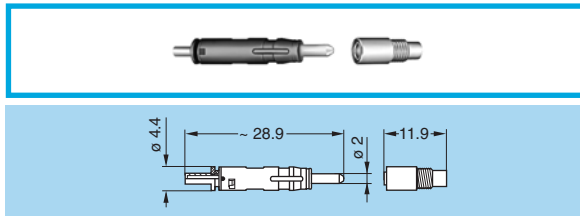

Part Number	For connector models	Cable structure	Cable ø
PST.F2.BA2.LCE10	FGW, FMW, FUW	Buffer coated fibre	0.25 to 1.1

PSS.F2 Alignment device for F2 female fibre optic contact

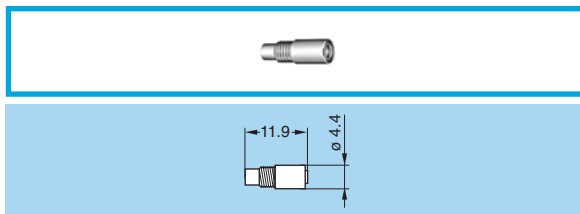

Part Number
PSS.F2.290.NZZ

Note: Alignment device should be ordered as replacement item.

Note: all dimensions are in millimetre.

Cables – ARIB, SMPTE & EBU mixed camera cables

Mixed camera cables have been specially designed for HDTV Broadcast requirements resulting in the primary standards in Japan and USA.

These standards are fairly similar, except for the colour coding of the control cores. While the diameter of the central strength member is the same in

both standards (1.8 mm) some manufacturers use 1.6 mm only.

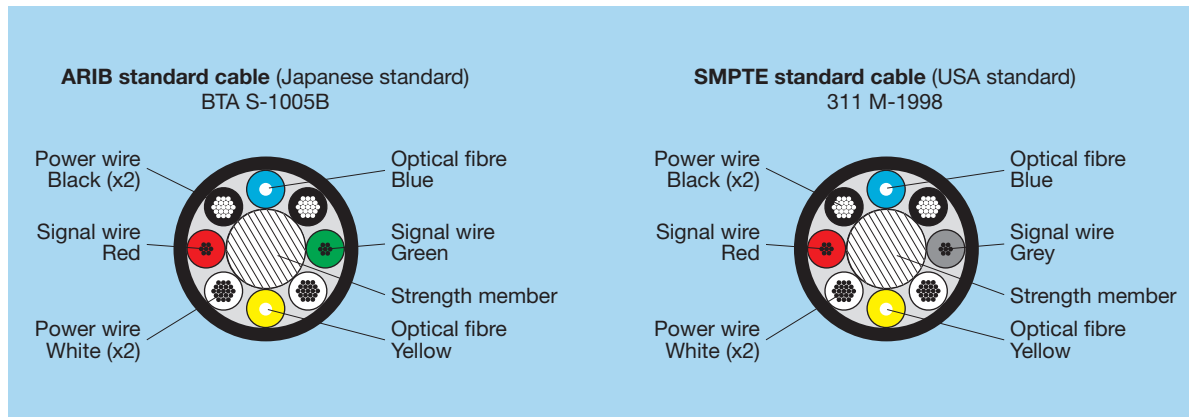

Rugged HDTV camera cable

Cables in broadcast need to have high resistance against flexing and twisting,

which is a challenge for fragile fibre optic cables. These cables require good

abrasion resistance, load bearing as well as tensile strength capabilities.

SMPTE 311M-1998 (USA standard connector)

Optical fibre	Typical data
Attenuation (1300 μm)	0.8 dB/km
Core diameter	$9.5 \pm 1 \mu\text{m}$
Cladding diameter	$125 \pm 1 \mu\text{m}$
Buffer diameter	$0.9 \pm 0.05\text{mm}$

Mechanical properties of cable	Typical data
Tensile strength	700N minimum
Cyclic flexing	15000 cycles
Bend radius	7 x diameters

Power conductor	Typical data
Conductor resistance	< 43 Ω/km
Insulation resistance	> 10000 $\text{M}\Omega/\text{km}$
Withstand voltage	1750 Vrms

Signal conductor	Typical data
Conductor resistance	< 184 Ω/km
Insulation resistance	> 10000 $\text{M}\Omega/\text{km}$
Withstand voltage	1750 Vrms

EBU R100-1999 (European standard connector)

General specifications	Typical data
Temperature	-40°C to $+80^\circ \text{C}$
Humidity	90-95% relative humidity at $40^\circ \text{C} \pm 2$ for 96 hours
Durability	10000 cycles

Optical specifications	Typical data
Fibre core/cladding ϕ	9/125 μm , single (SM) fibre
Insertion loss	less than 0.5 dB at 1300 nm ²
Return loss	better than -45 dB (machine polishing)

Power conductor	Typical data
Voltage	600 Vrms (maximum working voltage)
Current	10 A (maximum working current)

Signal conductor	Typical data
Voltage	42 Vrms or 60 Vrms (maximum working voltage)
Current	3 A (maximum working current)

Accessories

GMA Bend relief

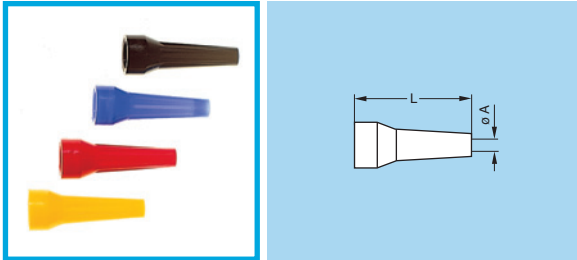

Part Number	Cable group	Dim. (mm)	
		A	L
GMA.3B.090.DN	2-4	9	42
GMA.4B.011.DN	3	11	60

Ref.	Colour	Ref.	Colour	Ref.	Colour
A	blue	J	yellow	R	red
B	white	M	brown	S	orange
G	grey	N	black	V	green

Note: The last letter «N» of the part number indicates the colour black of the bend relief. For others colour, refer to the adjacent table and replace letter «N» by the letter of the colour required.

GMF Bend relief with cap



Part Number	For connector model
GMF.3K.085.EANZ	FUW

Material: black EPDM

GMP Bend relief with cap



Part Number	For connector model
GMP.3K.085.EANZ	PUW

Material: black EPDM

GMF Coloured ring for bend relief with cap

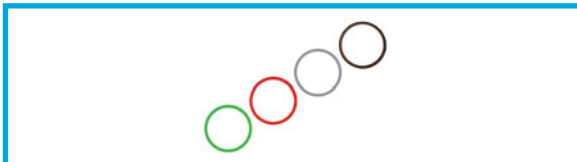

Part Number	Colour
GMF.3K.265.RG	grey
GMF.3K.265.RN	black
GMF.3K.265.RR	red
GMF.3K.265.RV	green

Material: Silicone

B●● Blanking caps

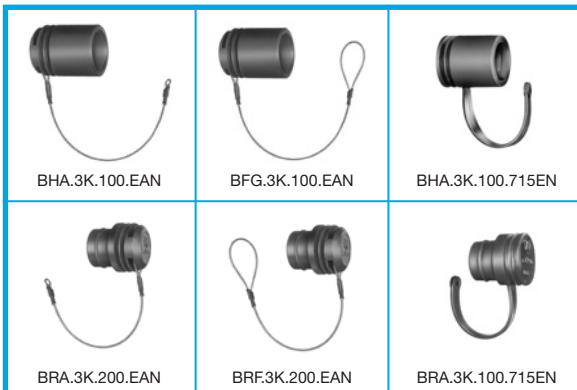

Part Number	For connector model
BHA.3K.100.EAN	FMW, FXW
BRA.3K.200.EAN	EDW, PEW
BFG.3K.100.EAN	FMW, FXW
BRF.3K.200.EAN	PUW
BHA.3K.100.715EN	FMW, FXW
BRA.3K.100.715EN	EBW, EDW, ENW, PBW, PEW

Material: black EPDM

GM● Gaiters

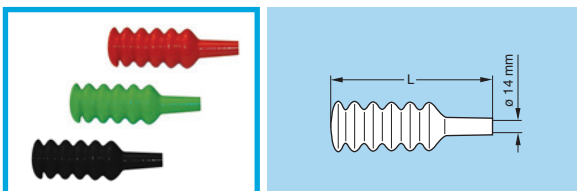

Part Number	Colour	Dimension L (mm)	For connector model
GMP.3K.140.165PER	red	165	PUW
GMP.3K.140.165PEN	black	165	PUW
GMF.3K.140.156PEV	green	156	FUW
GMF.3K.140.156PEN	black	156	FUW

Material: PVC

BRR Spring loaded dust cap for EDW and EBW

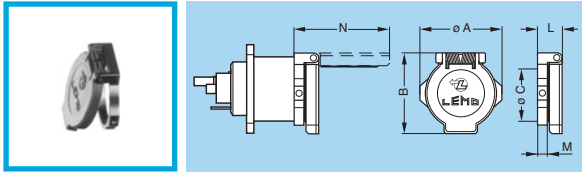

Part Number	Dimensions (mm)					
	A	B	C	L	M	N
BRR.3K.200.PZSG	29	29	23	8.1	3	33.2

Note: On request, this cap is available in black. If so replace the last letter «G» of the part number by «N».

Material: Polyoxymethylene (POM) grey (or black)

Patch panels

PB Patch panel



2U panel with one row of 6 or 10 plugs or sockets (receptacles) of the 3K.93C Series.

P B G . 3 K . 9 3 C . M W 9 6 0 6

Ref.	Colour
C	beige
G	grey
N	black
T	nat. anod.

Ref.	Front side connection
MW	Plug FMW
EW	Socket (receptacle) PEW
BW	Socket (receptacle) PBW

Ref.	Cable ϕ (mm)	Nb of connectors
9606	8.9 to 9.5	6
1206	11.6 to 12.4	6
9610	8.9 to 9.5	10
1210	11.6 to 12.4	10

Cable assembly

MFP Cable assembly

Assembly cable with one straight plug (FUW) and one straight socket (receptacle) (PUW), both complete with GMF/GMP bend relief with cap.

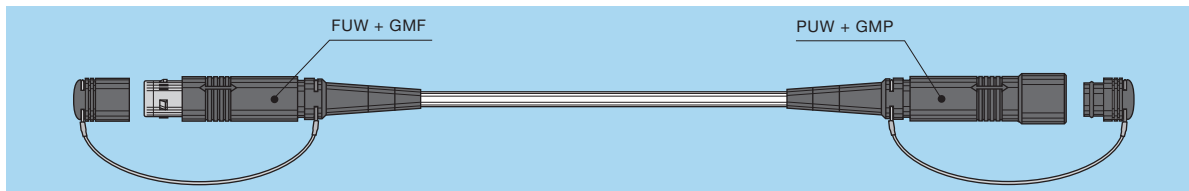

Part Number	Description	Cable type
MFP.3K.93C.092M025	25 meter length	2SM-9.2-37.5
MFP.3K.93C.092M050	50 meter length	2SM-9.2-37.5
MFP.3K.93C.092M100	100 meter length	2SM-9.2-37.5
MFP.3K.93C.092M200	200 meter length	2SM-9.2-37.5

Part Number	Description	Cable type
MFP.3K.93C.120M025	25 meter length	2SM-12-15
MFP.3K.93C.120M050	50 meter length	2SM-12-15
MFP.3K.93C.120M100	100 meter length	2SM-12-15
MFP.3K.93C.120M200	200 meter length	2SM-12-15

Part Number	Description	Cable type
MFP.3K.93C.160M025	25 meter length	2SM-16-37.5
MFP.3K.93C.160M050	50 meter length	2SM-16-37.5
MFP.3K.93C.160M100	100 meter length	2SM-16-37.5
MFP.3K.93C.160M200	200 meter length	2SM-16-37.5

Panel cut-outs

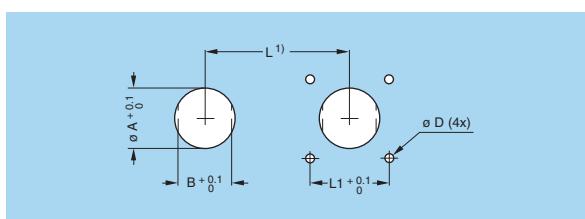

Models	Dimensions (mm)				
	A	B	D	L	L1
FMW, FXW	22.6	-	3.2 or M3	39	20.6
EBW	23.1	-	3.2 or M3	30	23.0
EDW	18.1	-	3.2 or M3	30	23.0
ENW, PEW	24.2	22.6	-	32	-
PBW	19.2	-	3.2 or M3	30	23.0

Note: 1) Minimum distance between two neighbouring components.

Tooling

DRV Complete workstation for fibre optic contact

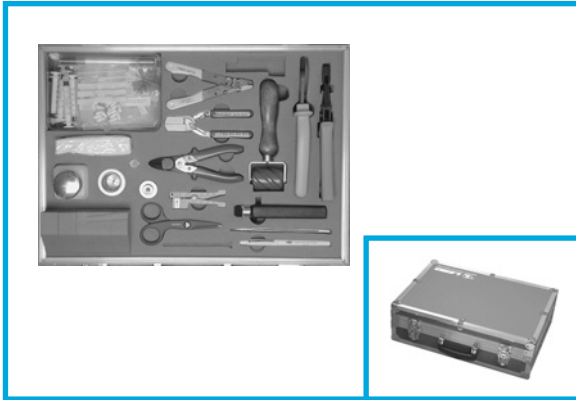

Part Number	Contact type
DRV.91.CF2.PN	F2

Note: other tools such as polishing machine and optical test instrument are also necessary.

Part Number	Description
DRV.91.CF2.PN	Standard F2 contact termination workstation
DPE.99.524.337K	Crimping tool for fibre optic contact
DCS.91.F12.3LA	Epoxy curing jig
WST.FR.220.VA	Epoxy curing oven (220 V)
WST.FR.110.VA	Epoxy curing oven (110 V)
DCC.91.312.5LA	Extractor for fibre optic contact (assembly house)
DCP.91.023.TN	Spanner for tightening collet nut

Part Number	Description
DPD.99.010.5K	Crimping tool for screen crimping on FUW and PUW
DPC.91.701.V	Manual crimping tool (signal contacts ϕ 0.9)
DPC.91.101.A	Manual crimping tool (power contacts ϕ 1.3)
DCC.91.131.5LA	Extraction tool, crimp cont. ϕ 1.3 (thumb operated model)
DCF.92.090.3LT	Extraction tool, crimp cont. ϕ 0.9 (automatic model)
DCF.91.133.5LT	Extraction tool, crimp cont. ϕ 1.3 (automatic model)
FFS.F2.BA2.EZZ	Dummy ferrule for polishing

DCS.3K.175.72LN Cable puller



The LEMO cable puller, is a pull through tool that allows passing the cable through narrow sections and protects the optical fibre during installation.

•UW Parts for field repair with pre-terminated F2 contact



Part Number (Repair kit for FUW plug)	Content part number	Description	Quantity
FUW.3K.93C.ZLMC96W	EGW.3K.444.EL	Insulator for plug	1
	EGG.3B.660.ZZM	Contact for signal	2
	FGW.3K.565.ZZC	Contact for power	2
	PST.F2.BA2.LCE10	Pre-terminated F2 contact	2
	FGW.3K.146.ZZA	Anchor with screws	1
	FFS.3K.130.LNV	Earthing body with o-ring	1
	FFS.3K.160.DN	Crimp ring	1
	GDA.99.140.100VK	O-ring for backshell	1
GMA.30.025.CN	Protection sleeve	2	
Part Number (Repair kit for PUW socket/receptacle)	Content part number	Description	Quantity
PUW.3K.93C.ZLCC96W	FGW.3K.344.EL	Insulator for socket (recep.)	1
	FGG.3B.560.ZZC	Contact for signal	2
	EGW.3K.666.ZZM	Contact for power	2
	FFT.F2.BA2.LCE10	Pre-terminated F2 contact	2
	FGW.3K.146.ZZA	Anchor with screws	1
	FFS.3K.130.LNV	Earthing body with o-ring	1
	FFS.3K.160.DN	Crimp ring	1
	GDA.99.140.100VK	O-ring for backshell	1
GMA.30.025.CN	Protection sleeve	2	

Tooling for field termination

Part Number	Description
DCE.91.093.BVC	Positioner for signal ¹⁾ (male), 0.9 mm
DCE.91.093.BVM	Positioner for signal ¹⁾ (female), 0.9 mm
DCE.91.133.BVCW	Positioner for power ²⁾ (male and female), 1.3 mm
WST.OU.110.20PN	Fibre cleaver for pre-terminated contact
DPD.99.010.5K	Crimping tool for cable group 2-4 (FUW and PUW)
DPD.99.301.3K	Crimping tool for cable group 3 (FUW and PUW)

Part Number	Description
DPC.91.701.V	Manual crimping tool (signal contacts ø 0.9)
DPC.91.101.A	Manual crimping tool (power contacts ø 1.3)
DPC.91.023.TN	Spanner for tightening collet nut
WST.PN.102.3CR	Primary coat stripper

Note:

- 1) These positioners are suitable for use with both manual and pneumatic crimping tools according to the MIL-C-22520/7-01 standard.
 2) These turrets can be used with manual crimping tool according to MIL-C-22520/1-01 standard. Power contacts are special with an oversized crimp barrel.

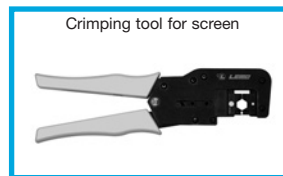
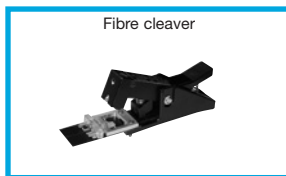
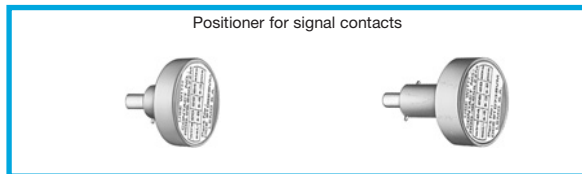

Maintenance tools

DCS.91.F23.LA Cleaning tool F2 contact

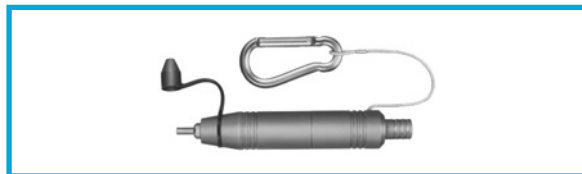

Used for maintenance cleaning. The tool is made with a sponge alcohol reservoir (supplied empty). 16 dry cotton buds are included. The threaded end allows extraction/reinstallation of the F2 contact alignment device.

WST.KI.125.34 Cleaning kit F2 contact



Fibre optic cleaning kit of 2 cotton buds, 1 dry and 1 being soaked in IPA (Isopropyl Alcohol) used for cleaning the fibre optic contacts.

DCS.F2.035.PN Alignment device tool



Simple tool with two threaded end for installation/extraction of the F2 contact alignment device. For use with WST.KI.125.34 kit above.

DCT.F2.125.PA Fibre Optic ferrule cleaner



This cleaning tool comes with a bush for different cleaning configurations. More than 500 cleaning per cleaner. This cleaner is for on-site purposes only and should not replace regular maintenance cleaning with cotton buds and alcohol.

WST.FB.CI1.10US2 Video inspection viewer



A portable fibre optic viewer for F2 contact consisting of handset probe, LCD display, ferrule tips for LEMO contacts & software & United States - AC power supply all in a rugged case. European power supply version (WST.FB.CI1.10EU2). An optional USB capture device is also available (Part number: WST.FB.CI1.00USB2)

DCS.F2.N02.PA Fibre Optic one-click cleaner



Insert the one-click cleaner into the insulator and push until an audible "click" is heard. The cleaner uses a mechanical push action to advance an optical grade cleaning tape. More than 500 cleaning per cleaner. Product includes special LEMO F2 ferrule adaptor.

LEMO HEADQUARTERS

SWITZERLAND

LEMO SA

Chemin des Champs-Courbes 28 - P.O. Box 194 - CH-1024 Ecublens
Tel. (+41 21) 695 16 00 - Fax (+41 21) 695 16 02 - e-mail: info@lemo.com

LEMO SUBSIDIARIES

AUSTRIA

LEMO Elektronik GesmbH

Lemböckgasse 49/E6-3
1230 Wien
Tel: (+43 1) 914 23 20 0
Fax: (+43 1) 914 23 20 11
sales@lemo.at

CHINA

LEMO Trading (Shanghai) Co., Ltd

LEMO Electronics (Shanghai) Co., Ltd

5th Floor, Block 6, City of ELITE,
1000 Jinhai Road, Pudong
Shanghai, China 201206
Tel: (+86 21) 5899 7721
Fax: (+86 21) 5899 7727
cn.sales@lemo.com

DENMARK

LEMO Denmark A/S

Gammel Mosevej 46
2820 Gentofte
Tel: (+45) 45 20 44 00
Fax: (+45) 45 20 44 01
info-dk@lemo.com

FRANCE

LEMO France Sàrl

15/19 Avenue Graham Bell
Bâtiment Balthus 4
Bussy Saint Georges
77607 Marne la Vallée Cedex 3
Tel: (+33 1) 60 94 60 94
Fax: (+33 1) 60 94 60 90
info-fr@lemo.com

GERMANY

LEMO Elektronik GmbH

Hanns-Schwindt-Str. 6
81829 München
Tel: (+49 89) 42 77 03
Fax: (+49 89) 420 21 92
info@lemo.de

HONG KONG

LEMO Hong Kong Ltd

Unit 1207, 12/F, Corporation Square,
8 Lam Lok Street, Kowloon Bay,
Kowloon - Hong Kong
Tel: (+852) 2174 0468
Fax: (+852) 2174 0492
hk.sales@lemo.com

HUNGARY

REDEL Elektronika Kft

Nagysándor József u. 6-12
1201 Budapest
Tel: (+36 1) 421 47 10
Fax: (+36 1) 421 47 57
redelemo@lemo.hu

ITALY

LEMO Italia srl

Viale Lunigiana 25
20125 Milano
Tel: (+39 02) 66 71 10 46
Fax: (+39 02) 66 71 10 66
sales.it@lemo.com

JAPAN

LEMO Japan Ltd

4-10-3, Takaido Higashi,
Suginami-ku, Tokyo, 168-0072
Tel: (+81 3) 53 44 39 33
Fax: (+81 3) 53 44 39 35
lemoinfo@lemo.co.jp

NETHERLANDS / BELGIUM

LEMO Connectors Benelux

De Trompet 2108
1967 DC Heemskerk
Tel. (+31) 251 25 78 20
Fax (+31) 251 25 78 21
info@lemo.nl

NORWAY / ICELAND

LEMO Norway A/S

Stanseveien 6B
0975 Oslo
Tel: (+47) 22 91 70 40
Fax: (+47) 22 91 70 41
info-no@lemo.com

SINGAPORE

LEMO Asia Pte Ltd

4 Leng Kee Road,
#06-09 SiS Building
Singapore 159088
Tel: (+65) 6476 0672
Fax: (+65) 6474 0672
sg.sales@lemo.com

SPAIN / PORTUGAL

IBERLEMO S.A.

Brasil, 45, 08402 Granollers
Barcelona
Tel: (+34 93) 860 44 20
Fax: (+34 93) 879 10 77
info-es@lemo.com

Madrid Office
Antonio López, 96, 28019 Madrid
Tel: (+34 91) 469 99 19
Fax: (+34 91) 469 99 59

SWEDEN / FINLAND

LEMO Nordic AB

Mariehällsvägen 39A
168 65 Bromma
Tel: (+46 8) 635 60 60
Fax: (+46 8) 635 60 61
info-se@lemo.com

SWITZERLAND

LEMO Verkauf AG

Grundstrasse 22 B
6343 Rotkreuz
Tel: (+41 41) 790 49 40
Fax: (+41 41) 790 49 43
ch.sales@lemo.com

UNITED KINGDOM

LEMO UK Ltd

12-20 North Street
Worthing
West Sussex, BN11 1DU
Tel: (+44 1903) 23 45 43
Fax: (+44 1903) 20 62 31
lemouk@lemo.com

USA

LEMO USA Inc

P.O. Box 2408
Rohnert Park, CA 94927-2408
Tel: (+1 707) 578 88 11
(+1 800) 444 53 66
Fax: (+1 707) 578 08 69
info@lemousa.com

LEMO DISTRIBUTORS

AUSTRALIA, BRAZIL, CANADA, CZECH REPUBLIC, GREECE, INDIA, ISRAEL,
NEW ZEALAND, PAKISTAN, POLAND, RUSSIA, SOUTH AFRICA, SOUTH KOREA,
TAIWAN, TURKEY, UKRAINE

www.lemo.com

Компания «Life Electronics» занимается поставками электронных компонентов импортного и отечественного производства от производителей и со складов крупных дистрибьюторов Европы, Америки и Азии.

С конца 2013 года компания активно расширяет линейку поставок компонентов по направлению коаксиальный кабель, кварцевые генераторы и конденсаторы (керамические, пленочные, электролитические), за счёт заключения дистрибьюторских договоров

Мы предлагаем:

- Конкуренеспособные цены и скидки постоянным клиентам.
- Специальные условия для постоянных клиентов.
- Подбор аналогов.
- Поставку компонентов в любых объемах, удовлетворяющих вашим потребностям.
- Приемлемые сроки поставки, возможна ускоренная поставка.
- Доставку товара в любую точку России и стран СНГ.
- Комплексную поставку.
- Работу по проектам и поставку образцов.
- Формирование склада под заказчика.
- Сертификаты соответствия на поставляемую продукцию (по желанию клиента).
- Тестирование поставляемой продукции.
- Поставку компонентов, требующих военную и космическую приемку.
- Входной контроль качества.
- Наличие сертификата ISO.

В составе нашей компании организован Конструкторский отдел, призванный помогать разработчикам, и инженерам.

Конструкторский отдел помогает осуществить:

- Регистрацию проекта у производителя компонентов.
- Техническую поддержку проекта.
- Защиту от снятия компонента с производства.
- Оценку стоимости проекта по компонентам.
- Изготовление тестовой платы монтаж и пусконаладочные работы.



Тел: +7 (812) 336 43 04 (многоканальный)

Email: org@lifeelectronics.ru