

FEATURES

Fast throughput rate: 1 MSPS

Specified for V_{DD} of 2.35 V to 5.25 V

Low power

3.6 mW at 1 MSPS with 3 V supplies

12.5 mW at 1 MSPS with 5 V supplies

Wide input bandwidth

71 dB SNR at 100 kHz input frequency

Flexible power/serial clock speed management

No pipeline delays

High speed serial interface

SPI/QSPI™/MICROWIRE/DSP compatible

Standby mode: 1 μ A maximum

6-lead SC70 package

8-lead MSOP

Qualified for automotive applications

APPLICATIONS

Battery-powered systems

Personal digital assistants

Medical instruments

Mobile communications

Instrumentation and control systems

Data acquisition systems

High speed modems

Optical sensors

GENERAL DESCRIPTION

The [AD7476A/AD7477A/AD7478A](#) are 12-bit, 10-bit, and 8-bit high speed, low power, successive-approximation analog-to-digital converters (ADCs), respectively. The parts operate from a single 2.35 V to 5.25 V power supply and feature throughput rates up to 1 MSPS. The parts contain a low noise, wide bandwidth track-and-hold amplifier that can handle input frequencies in excess of 13 MHz. The conversion process and data acquisition are controlled using \overline{CS} and the serial clock, allowing the devices to interface with microprocessors or DSPs. The input signal is sampled on the falling edge of \overline{CS} , and the conversion is also initiated at this point. There are no pipeline delays associated with the parts. The [AD7476A/AD7477A/AD7478A](#) use advanced design techniques to achieve low power dissipation at high throughput rates. The reference for the part is taken internally from V_{DD} to allow the widest dynamic input range to the ADC. Thus, the analog input range for the part is 0 V to V_{DD} . The conversion rate is determined by the SCLK.

Rev. G

[Document Feedback](#)

Information furnished by Analog Devices is believed to be accurate and reliable. However, no responsibility is assumed by Analog Devices for its use, nor for any infringements of patents or other rights of third parties that may result from its use. Specifications subject to change without notice. No license is granted by implication or otherwise under any patent or patent rights of Analog Devices. Trademarks and registered trademarks are the property of their respective owners.

FUNCTIONAL BLOCK DIAGRAM



Figure 1.

02830-001

PRODUCT HIGHLIGHTS

1. First 12-/10-/8-bit ADCs in a SC70 package.
2. High throughput with low power consumption.
3. Flexible power/serial clock speed management. The conversion rate is determined by the serial clock, allowing the conversion time to be reduced through the serial clock speed increase. This allows the average power consumption to be reduced when a power-down mode is used while not converting. The parts also feature a power-down mode to maximize power efficiency at lower throughput rates. Current consumption is 1 μ A maximum and 50 nA typically when in power-down mode.
4. Reference derived from the power supply.
5. No pipeline delay. The parts feature a standard successive approximation ADC with accurate control of the sampling instant via a \overline{CS} input and once-off conversion control.

TABLE OF CONTENTS

Features	1	Typical Connection Diagram	16
Applications.....	1	Analog Input	16
Functional Block Diagram	1	Digital Inputs	17
General Description	1	Modes of Operation	18
Product Highlights	1	Normal Mode.....	18
Revision History	2	Power-Down Mode.....	18
Specifications.....	3	Power-Up Time	18
AD7476A Specifications.....	3	Power vs. Throughput Rate.....	20
AD7477A Specifications.....	5	Serial Interface	21
AD7478A Specifications.....	6	AD7478A in a 12 SCLK Cycle Serial Interface.....	22
Timing Specifications	8	Microprocessor Interfacing.....	23
Absolute Maximum Ratings.....	10	AD7476A/AD7477A/AD7478A to ADSP-2181 Interface.....	23
ESD Caution.....	10	AD7476A/AD7477A/AD7478A to DSP563xx Interface	24
Pin Configurations and Function Descriptions	11	Application Hints	25
Typical Performance Characteristics	12	Grounding and Layout	25
Terminology	14	Outline Dimensions.....	26
Theory of Operation	15	Ordering Guide	26
Circuit Information.....	15	Automotive Products.....	27
The Converter Operation.....	15		
ADC Transfer Function.....	15		

REVISION HISTORY

1/16—Rev. F to Rev. G

Changes to Table 5.....	10
Changed AD7476A/AD7477A/AD7478A to ADSP-218x Interface Section to AD7476A/AD7477A/AD7478A to ADSP-2181 Section	23
Deleted AD7476A/AD7477A/AD7478A to TMS320C541 Interface Section and Figure 28; Renumbered Sequentially	23
Deleted Evaluating the AD7476A/AD7477A Performance Section.....	25
Changes to Ordering Guide	26

1/11—Rev. E to Rev. F

Changes to Features Section	1
Changes to Ordering Guide	26
Added Automotive Products Section	27

2/09—Rev. D to Rev. E

Changes to Features	1
Changes to Ordering Guide	26

4/06—Rev. C to Rev. D

Updated Format.....	Universal
Changes to Ordering Guide	26

SPECIFICATIONS

AD7476A SPECIFICATIONS

$V_{DD} = 2.35\text{ V to }5.25\text{ V}$, $f_{SCLK} = 20\text{ MHz}$, $f_{SAMPLE} = 1\text{ MSPS}$, $T_A = T_{MIN}$ to T_{MAX} , unless otherwise noted.¹

Table 1.

Parameter	A Grade ²	B Grade ²	Y Grade ²	Unit	Test Conditions/Comments	
DYNAMIC PERFORMANCE						
Signal-to-Noise-and-Distortion (SINAD) ³	70	70	70	dB min	$f_{IN} = 100\text{ kHz sine wave}$ $V_{DD} = 2.35\text{ V to }3.6\text{ V}$, $T_A = 25^\circ\text{C}$	
	69	69	69	dB min	$V_{DD} = 2.4\text{ V to }3.6\text{ V}$	
	71.5	71.5	71.5	dB typ	$V_{DD} = 2.35\text{ V to }3.6\text{ V}$	
	69	69	69	dB min	$V_{DD} = 4.75\text{ V to }5.25\text{ V}$, $T_A = 25^\circ\text{C}$	
	68	68	68	dB min	$V_{DD} = 4.75\text{ V to }5.25\text{ V}$	
	71	71	71	dB min	$V_{DD} = 2.35\text{ V to }3.6\text{ V}$, $T_A = 25^\circ\text{C}$	
Signal-to-Noise Ratio (SNR) ³	70	70	70	dB min	$V_{DD} = 2.4\text{ V to }3.6\text{ V}$	
	70	70	70	dB min	$V_{DD} = 4.75\text{ V to }5.25\text{ V}$, $T_A = 25^\circ\text{C}$	
	69	69	69	dB min	$V_{DD} = 4.75\text{ V to }5.25\text{ V}$	
	69	69	69	dB min	$V_{DD} = 4.75\text{ V to }5.25\text{ V}$	
Total Harmonic Distortion (THD) ³	-80	-80	-80	dB typ		
Peak Harmonic or Spurious Noise (SFDR) ³	-82	-82	-82	dB typ		
Intermodulation Distortion (IMD) ³						
	Second-Order Terms	-84	-84	-84	dB typ	$f_a = 100.73\text{ kHz}$, $f_b = 90.72\text{ kHz}$
	Third-Order Terms	-84	-84	-84	dB typ	$f_a = 100.73\text{ kHz}$, $f_b = 90.72\text{ kHz}$
Aperture Delay	10	10	10	ns typ		
Aperture Jitter	30	30	30	ps typ		
Full Power Bandwidth	13.5	13.5	13.5	MHz typ	At 3 dB	
	2	2	2	MHz typ	At 0.1 dB	
DC ACCURACY						
Resolution	12	12	12	Bits	B and Y grades ⁴	
Integral Nonlinearity ³	± 0.75	± 1.5	± 1.5	LSB max	Guaranteed no missed codes to 12 bits	
	± 0.75	$-0.9/+1.5$	$-0.9/+1.5$	LSB typ		
Differential Nonlinearity	± 0.75	$-0.9/+1.5$	$-0.9/+1.5$	LSB max		
	± 0.75	$-0.9/+1.5$	$-0.9/+1.5$	LSB typ		
Offset Error ^{3,5}	± 1.5	± 1.5	± 1.5	LSB max		
	± 1.5	± 0.2	± 0.2	LSB typ		
Gain Error ^{3,5}	± 1.5	± 1.5	± 1.5	LSB max		
	± 1.5	± 0.5	± 0.5	LSB typ		
Total Unadjusted Error (TUE) ^{3,5}	± 2	± 2	± 2	LSB max		
ANALOG INPUT						
Input Voltage Range	0 to V_{DD}	0 to V_{DD}	0 to V_{DD}	V		
DC Leakage Current	± 0.5	± 0.5	± 0.5	$\mu\text{A max}$		
Input Capacitance	20	20	20	pF typ	Track-and-hold in track; 6 pF typ when in hold	
LOGIC INPUTS						
Input High Voltage, V_{INH}	2.4	2.4	2.4	V min	$V_{DD} = 2.35\text{ V}$ $V_{DD} = 5\text{ V}$ $V_{DD} = 3\text{ V}$ Typically 10 nA, $V_{IN} = 0\text{ V or }V_{DD}$	
	1.8	1.8	1.8	V min		
Input Low Voltage, V_{INL}	0.8	0.8	0.8	V max		
	0.4	0.4	0.4	V max		
Input Current, I_{IN} , SCLK Pin	± 0.5	± 0.5	± 0.5	$\mu\text{A max}$		
Input Current, I_{IN} , $\overline{\text{CS}}$ Pin	± 10	± 10	± 10	nA typ		
Input Capacitance, C_{IN} ⁶	5	5	5	pF max		

Parameter	A Grade ²	B Grade ²	Y Grade ²	Unit	Test Conditions/Comments
LOGIC OUTPUTS					
Output High Voltage, V_{OH}	$V_{DD} - 0.2$	$V_{DD} - 0.2$	$V_{DD} - 0.2$	V min	$I_{SOURCE} = 200 \mu A$; $V_{DD} = 2.35 V$ to $5.25 V$ $I_{SINK} = 200 \mu A$
Output Low Voltage, V_{OL}	0.4	0.4	0.4	V max	
Floating-State Leakage Current	± 1	± 1	± 1	μA max	
Floating-State Output Capacitance ⁶	5	5	5	pF max	
Output Coding	Straight (Natural) Binary				
CONVERSION RATE					
Conversion Time	800	800	800	ns max	16 SCLK cycles
Track-and-Hold Acquisition Time ³	250	250	250	ns max	
Throughput Rate	1	1	1	MSPS max	See Serial Interface section
POWER REQUIREMENTS					
V_{DD}	2.35/5.25	2.35/5.25	2.35/5.25	V min/max	Digital I/Ps = 0 V or V_{DD} $V_{DD} = 4.75 V$ to $5.25 V$, SCLK on or off $V_{DD} = 2.35 V$ to $3.6 V$, SCLK on or off $V_{DD} = 4.75 V$ to $5.25 V$, $f_{SAMPLE} = 1$ MSPS $V_{DD} = 2.35 V$ to $3.6 V$, $f_{SAMPLE} = 1$ MSPS Typically 50 nA $V_{DD} = 5 V$, $f_{SAMPLE} = 100$ KSPS $V_{DD} = 3 V$, $f_{SAMPLE} = 100$ KSPS $V_{DD} = 5 V$, $f_{SAMPLE} = 1$ MSPS $V_{DD} = 3 V$, $f_{SAMPLE} = 1$ MSPS $V_{DD} = 5 V$ $V_{DD} = 3 V$
I_{DD}					
Normal Mode (Static)	2.5	2.5	2.5	mA typ	
	1.2	1.2	1.2	mA typ	
Normal Mode (Operational)	3.5	3.5	3.5	mA max	
	1.7	1.7	1.7	mA max	
Full Power-Down Mode (Static)	1	1	1	μA max	
Full Power-Down Mode (Dynamic)	0.6	0.6	0.6	mA typ	
Power Dissipation ⁷	0.3	0.3	0.3	mA typ	
Normal Mode (Operational)	17.5	17.5	17.5	mW max	
	5.1	5.1	5.1	mW max	
Full Power-Down Mode	5	5	5	μW max	
	3	3	3	μW max	

¹ Temperature ranges are as follows: A, B grades from $-40^{\circ}C$ to $+85^{\circ}C$, Y grade from $-40^{\circ}C$ to $+125^{\circ}C$.

² Operational from $V_{DD} = 2.0 V$, with input low voltage (V_{INL}) 0.35 V maximum.

³ See the Terminology section.

⁴ B and Y grades, maximum specifications apply as typical figures when $V_{DD} = 4.75 V$ to $5.25 V$.

⁵ SC70 values guaranteed by characterization.

⁶ Guaranteed by characterization.

⁷ See the Power vs. Throughput Rate section.

AD7477A SPECIFICATIONS

$V_{DD} = 2.35\text{ V to }5.25\text{ V}$, $f_{SCLK} = 20\text{ MHz}$, $f_{SAMPLE} = 1\text{ MSPS}$, $T_A = T_{MIN}$ to T_{MAX} , unless otherwise noted.¹

Table 2.

Parameter	A Grade ²	Unit	Test Conditions/Comments
DYNAMIC PERFORMANCE			
Signal-to-Noise-and-Distortion (SINAD) ³	61	dB min	$f_{IN} = 100\text{ kHz sine wave}$
Total Harmonic Distortion (THD) ³	-72	dB max	
Peak Harmonic or Spurious Noise (SFDR) ³	-73	dB max	
Intermodulation Distortion (IMD) ³			
Second-Order Terms	-82	dB typ	$f_a = 100.73\text{ kHz}, f_b = 90.7\text{ kHz}$
Third-Order Terms	-82	dB typ	$f_a = 100.73\text{ kHz}, f_b = 90.7\text{ kHz}$
Aperture Delay	10	ns typ	
Aperture Jitter	30	ps typ	
Full Power Bandwidth	13.5	MHz typ	At 3 dB
	2	MHz typ	At 0.1 dB
DC ACCURACY			
Resolution	10	Bits	
Integral Nonlinearity	±0.5	LSB max	Guaranteed no missed codes to 10 bits
Differential Nonlinearity	±0.5	LSB max	
Offset Error ^{3,4}	±1	LSB max	
Gain Error ^{3,4}	±1	LSB max	
Total Unadjusted Error (TUE) ^{3,4}	±1.2	LSB max	
ANALOG INPUT			
Input Voltage Range	0 to V_{DD}	V	
DC Leakage Current	±0.5	µA max	
Input Capacitance	20	pF typ	Track-and-hold in track; 6 pF typ when in hold
LOGIC INPUTS			
Input High Voltage, V_{INH}	2.4	V min	$V_{DD} = 2.35\text{ V}$ $V_{DD} = 5\text{ V}$ $V_{DD} = 3\text{ V}$ Typically 10 nA, $V_{IN} = 0\text{ V}$ or V_{DD}
	1.8	V min	
Input Low Voltage, V_{INL}	0.8	V max	
	0.4	V max	
Input Current, I_{IN} , SCLK Pin	±0.5	µA max	
Input Current, I_{IN} , \overline{CS} Pin	±10	nA typ	
Input Capacitance, C_{IN} ⁵	5	pF max	
LOGIC OUTPUTS			
Output High Voltage V_{OH}	$V_{DD} - 0.2$	V min	$I_{SOURCE} = 200\text{ µA}, V_{DD} = 2.35\text{ V to }5.25\text{ V}$ $I_{SINK} = 200\text{ µA}$
Output Low Voltage, V_{OL}	0.4	V max	
Floating-State Leakage Current	±1	µA max	
Floating-State Output Capacitance ⁵	5	pF max	
Output Coding	Straight (Natural) Binary		
CONVERSION RATE			
Conversion Time	700	ns max	14 SCLK cycles with SCLK at 20 MHz
Track-and-Hold Acquisition Time ³	250	ns max	
Throughput Rate	1	MSPS max	

Parameter	A Grade ²	Unit	Test Conditions/Comments
POWER REQUIREMENTS			
V _{DD}	2.35/5.25	V min/max	
I _{DD}			Digital I/Ps = 0 V or V _{DD}
Normal Mode (Static)	2.5	mA typ	V _{DD} = 4.75 V to 5.25 V, SCLK on or off
	1.2	mA typ	V _{DD} = 2.35 V to 3.6 V, SCLK on or off
Normal Mode (Operational)	3.5	mA max	V _{DD} = 4.75 V to 5.25 V, f _{SAMPLE} = 1 MSPS
	1.7	mA max	V _{DD} = 2.35 V to 3.6 V, f _{SAMPLE} = 1 MSPS
Full Power-Down Mode (Static)	1	μA max	Typically 50 nA
Full Power-Down Mode (Dynamic)	0.6	mA typ	V _{DD} = 5 V, f _{SAMPLE} = 100 kSPS
Power Dissipation ⁶	0.3	mA typ	V _{DD} = 3 V, f _{SAMPLE} = 100 kSPS
Normal Mode (Operational)	17.5	mW max	V _{DD} = 5 V, f _{SAMPLE} = 1 MSPS
	5.1	mW max	V _{DD} = 3 V, f _{SAMPLE} = 1 MSPS
Full Power-Down Mode	5	μW max	V _{DD} = 5 V

¹ Temperature range is from –40°C to +85°C.

² Operational from V_{DD} = 2.0 V, with input high voltage (V_{INH}) 1.8 V minimum.

³ See the Terminology section.

⁴ SC70 values guaranteed by characterization.

⁵ Guaranteed by characterization.

⁶ See the Power vs. Throughput Rate section.

AD7478A SPECIFICATIONS

V_{DD} = 2.35 V to 5.25 V, f_{SCLK} = 20 MHz, f_{SAMPLE} = 1 MSPS, T_A = T_{MIN} to T_{MAX}, unless otherwise noted.¹

Table 3.

Parameter	A Grade ²	Unit	Test Conditions/Comments
DYNAMIC PERFORMANCE			
Signal-to-Noise-and-Distortion (SINAD) ³	49	dB min	f _{IN} = 100 kHz sine wave
Total Harmonic Distortion (THD) ³	–65	dB max	
Peak Harmonic or Spurious Noise (SFDR) ³	–65	dB max	
Intermodulation Distortion (IMD) ³			
Second-Order Terms	–76	dB typ	f _a = 100.73 kHz, f _b = 90.7 kHz
Third-Order Terms	–76	dB typ	f _a = 100.73 kHz, f _b = 90.7 kHz
Aperture Delay	10	ns typ	
Aperture Jitter	30	ps typ	
Full Power Bandwidth	13.5	MHz typ	At 3 dB
	2	MHz typ	At 0.1 dB
DC ACCURACY			
Resolution	8	Bits	
Integral Nonlinearity ³	±0.3	LSB max	
Differential Nonlinearity ³	±0.3	LSB max	Guaranteed no missed codes to eight bits
Offset Error ^{3,4}	±0.3	LSB max	
Gain Error ^{3,4}	±0.3	LSB max	
Total Unadjusted Error (TUE) ^{3,4}	±0.5	LSB max	
ANALOG INPUT			
Input Voltage Range	0 to V _{DD}	V	
DC Leakage Current	±0.5	μA max	
Input Capacitance	20	pF typ	Track-and-hold in track; 6 pF typ when in hold

Parameter	A Grade ²	Unit	Test Conditions/Comments
LOGIC INPUTS			
Input High Voltage, V_{INH}	2.4	V min	$V_{DD} = 2.35\text{ V}$ $V_{DD} = 5\text{ V}$ $V_{DD} = 3\text{ V}$ Typically 10 nA, $V_{IN} = 0\text{ V}$ or V_{DD}
Input Low Voltage, V_{INL}	1.8	V min	
Input Current, I_{IN} , SCLK Pin	0.8	V max	
Input Current, I_{IN} , CS Pin	0.4	V max	
Input Capacitance, C_{IN} ⁵	±0.5	µA max	
	±10	nA typ	
	5	pF max	
LOGIC OUTPUTS			
Output High Voltage, V_{OH}	$V_{DD} - 0.2$	V min	$I_{SOURCE} = 200\text{ µA}$, $V_{DD} = 2.35\text{ V}$ to 5.25 V $I_{SINK} = 200\text{ µA}$
Output Low Voltage, V_{OL}	0.4	V max	
Floating-State Leakage Current	±1	µA max	
Floating-State Output Capacitance ⁵	5	pF max	
Output Coding	Straight (Natural) Binary		
CONVERSION RATE			
Conversion Time	600	ns max	12 SCLK cycles with SCLK at 20 MHz
Track-and-Hold Acquisition Time ³	225	ns max	
Throughput Rate	1.2	MSPS max	
POWER REQUIREMENTS			
V_{DD}	2.35/5.25	V min/max	Digital I/Ps = 0 V or V_{DD} $V_{DD} = 4.75\text{ V}$ to 5.25 V , SCLK on or off $V_{DD} = 2.35\text{ V}$ to 3.6 V , SCLK on or off $V_{DD} = 4.75\text{ V}$ to 5.25 V $V_{DD} = 2.35\text{ V}$ to 3.6 V Typically 50 nA $V_{DD} = 5\text{ V}$, $f_{SAMPLE} = 100\text{ kSPS}$ $V_{DD} = 3\text{ V}$, $f_{SAMPLE} = 100\text{ kSPS}$ $V_{DD} = 5\text{ V}$ $V_{DD} = 3\text{ V}$ $V_{DD} = 5\text{ V}$
I_{DD}			
Normal Mode (Static)	2.5	mA typ	
	1.2	mA typ	
Normal Mode (Operational)	3.5	mA max	
	1.7	mA max	
Full Power-Down Mode (Static)	1	µA max	
Full Power-Down Mode (Dynamic)	0.6	mA typ	
Power Dissipation ⁶	0.3	mA typ	
Normal Mode (Operational)	17.5	mW max	
	5.1	mW max	
Full Power-Down Mode	5	µW max	

¹ Temperature range is from -40°C to $+85^{\circ}\text{C}$.

² Operational from $V_{DD} = 2.0\text{ V}$, with input high voltage (V_{INH}) 1.8 V minimum.

³ See the Terminology section.

⁴ SC70 values guaranteed by characterization.

⁵ Guaranteed by characterization.

⁶ See the Power vs. Throughput Rate section.

TIMING SPECIFICATIONS

$V_{DD} = 2.35 \text{ V to } 5.25 \text{ V}$; $T_A = T_{MIN} \text{ to } T_{MAX}$, unless otherwise noted.¹

Table 4.

Parameter	Limit at T_{MIN} , T_{MAX}	Unit	Description
f_{SCLK}^2	10	kHz min ³	A, B grades
	20	kHz min ³	Y grade
	20	MHz max	
$t_{CONVERT}$	$16 \times t_{SCLK}$		AD7476A
	$14 \times t_{SCLK}$		AD7477A
	$12 \times t_{SCLK}$		AD7478A
t_{QUIET}	50	ns min	Minimum quiet time required between bus relinquish and start of next conversion
t_1	10	ns min	Minimum \overline{CS} pulse width
t_2	10	ns min	\overline{CS} to SCLK setup time
t_3^4	22	ns max	Delay from \overline{CS} until SDATA three-state disabled
t_4^4	40	ns max	Data access time after SCLK falling edge
t_5	$0.4 t_{SCLK}$	ns min	SCLK low pulse width
t_6	$0.4 t_{SCLK}$	ns min	SCLK high pulse width
t_7^5			SCLK to data valid hold time
	10	ns min	$V_{DD} \leq 3.3 \text{ V}$
	9.5	ns min	$3.3 \text{ V} < V_{DD} \leq 3.6 \text{ V}$
	7	ns min	$V_{DD} > 3.6 \text{ V}$
t_8^6	36	ns max	SCLK falling edge to SDATA high impedance
	t_7 values also apply to t_8 minimum values	ns min	SCLK falling edge to SDATA high impedance
$t_{POWER-UP}^7$	1	μs max	Power-up time from full power-down

¹ Guaranteed by characterization. All input signals are specified with $t_r = t_f = 5 \text{ ns}$ (10% to 90% of V_{DD}) and timed from a voltage level of 1.6 V.

² Mark/space ratio for the SCLK input is 40/60 to 60/40.

³ Minimum f_{SCLK} at which specifications are guaranteed.

⁴ Measured with the load circuit shown in Figure 2, and defined as the time required for the output to cross 0.8 V or 1.8 V when $V_{DD} = 2.35 \text{ V}$, and 0.8 V or 2.0 V for $V_{DD} > 2.35 \text{ V}$.

⁵ Measured with a 50 pF load capacitor.

⁶ t_8 is derived from the measured time taken by the data outputs to change 0.5 V when loaded with the circuit shown in Figure 2. The measured number is then extrapolated back to remove the effects of charging or discharging the 50 pF capacitor. Therefore, the time, t_8 , quoted in the timing characteristics is the true bus relinquish time of the part and is independent of the bus loading.

⁷ See the Power-Up Time section.

Timing Diagrams



Figure 2. Load Circuit for Digital Output Timing Specifications

Timing Example 1

Having $f_{SCLK} = 20$ MHz and a throughput of 1 MSPS, a cycle time of

$$t_2 + 12.5 (1/f_{SCLK}) + t_{ACQ} = 1 \mu s$$

where:

$t_2 = 10$ ns min, leaving t_{ACQ} to be 365 ns. This 365 ns satisfies the requirement of 250 ns for t_{ACQ} .

From Figure 4, t_{ACQ} is comprised of

$$2.5 (1/f_{SCLK}) + t_8 + t_{QUIET}$$

where:

$t_8 = 36$ ns maximum. This allows a value of 204 ns for t_{QUIET} , satisfying the minimum requirement of 50 ns.

Timing Example 2

Having $f_{SCLK} = 5$ MHz and a throughput is 315 kSPS yields a cycle time of

$$t_2 + 12.5 (1/f_{SCLK}) + t_{ACQ} = 3.174 \mu s$$

where:

$t_2 = 10$ ns min, this leaves t_{ACQ} to be 664 ns. This 664 ns satisfies the requirement of 250 ns for t_{ACQ} .

From Figure 4, t_{ACQ} is comprised of

$$2.5 (1/f_{SCLK}) + t_8 + t_{QUIET}, t_8 = 36$$
 ns maximum

This allows a value of 128 ns for t_{QUIET} , satisfying the minimum requirement of 50 ns.

In this example and with other, slower clock values, the signal may already be acquired before the conversion is complete, but it is still necessary to leave 50 ns minimum t_{QUIET} between conversions. In Example 2, acquire the signal fully at approximately Point C in Figure 4.



Figure 3. AD7476A Serial Interface Timing Diagram

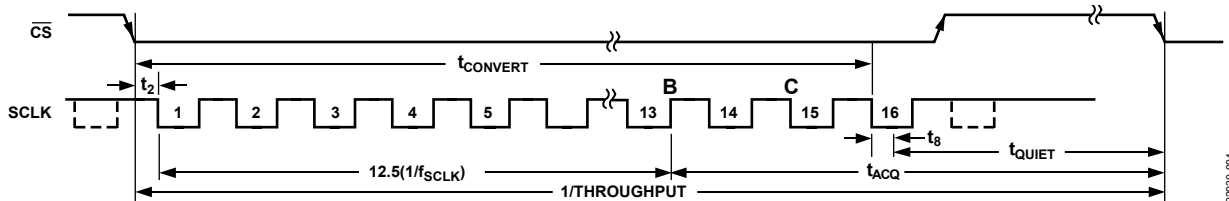

Figure 4. Serial Interface Timing Example

ABSOLUTE MAXIMUM RATINGS

$T_A = 25^\circ\text{C}$, unless otherwise noted. Transient currents of up to 100 mA do not cause SCR latch-up.

Table 5.

Parameter	Ratings
V_{DD} to GND	-0.3 V to +7 V
Analog Input Voltage to GND	-0.3 V to $V_{DD} + 0.3$ V
Digital Input Voltage to GND	-0.3 V to +7 V
Digital Output Voltage to GND	-0.3 V to $V_{DD} + 0.3$ V
Input Current to Any Pin Except Supplies	10 mA
Operating Temperature Range	
Commercial (A and B Grades)	-40°C to $+85^\circ\text{C}$
Industrial (Y Grade)	-40°C to $+125^\circ\text{C}$
Storage Temperature Range	-65°C to $+150^\circ\text{C}$
Junction Temperature	150°C
MSOP Package	
θ_{JA} Thermal Impedance	$205.9^\circ\text{C}/\text{W}$
θ_{JC} Thermal Impedance	$43.74^\circ\text{C}/\text{W}$
SC70 Package	
θ_{JA} Thermal Impedance	$340.2^\circ\text{C}/\text{W}$
θ_{JC} Thermal Impedance	$228.9^\circ\text{C}/\text{W}$
Lead Temperature, Soldering	
Reflow (10 sec to 30 sec)	$235 (0/+5)^\circ\text{C}$
Pb-Free Temperature Soldering	
Reflow	$255 (0/+5)^\circ\text{C}$
ESD	
AD7476AWYRMZ, AD7476AWYRMZ-RL7	2 kV
All Other Models	3.5 kV

Stresses at or above those listed under Absolute Maximum Ratings may cause permanent damage to the product. This is a stress rating only; functional operation of the product at these or any other conditions above those indicated in the operational section of this specification is not implied. Operation beyond the maximum operating conditions for extended periods may affect product reliability.

ESD CAUTION



ESD (electrostatic discharge) sensitive device. Charged devices and circuit boards can discharge without detection. Although this product features patented or proprietary protection circuitry, damage may occur on devices subjected to high energy ESD. Therefore, proper ESD precautions should be taken to avoid performance degradation or loss of functionality.

PIN CONFIGURATIONS AND FUNCTION DESCRIPTIONS

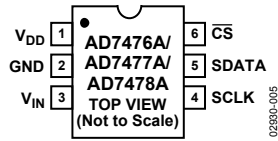

Figure 5. 6-Lead SC70 Pin Configuration



Figure 6. 8-Lead MSOP Pin Configuration

Table 6. Pin Function Descriptions

Mnemonic	Description
CS	Chip Select. Active low logic input. This input provides the dual function of initiating conversions on the AD7476A/AD7477A/AD7478A and also frames the serial data transfer.
V _{DD}	Power Supply Input. The V _{DD} range for AD7476A/AD7477A/AD7478A is from 2.35 V to 5.25 V.
GND	Analog Ground. Ground reference point for all circuitry on AD7476A/AD7477A/AD7478A . Refer all analog input signals to this GND voltage.
V _{IN}	Analog Input. Single-ended analog input channel. The input range is 0 V to V _{DD} .
SDATA	Data Out. Logic output. The conversion result from AD7476A/AD7477A/AD7478A is provided on this output as a serial data stream. The bits are clocked out on the falling edge of the SCLK input. The data stream from the AD7476A consists of four leading zeros followed by 12 bits of conversion data that are provided MSB first. The data stream from the AD7477A consists of four leading zeros followed by 10 bits of conversion data followed by two trailing zeros, provided MSB first. The data stream from the AD7478A consists of four leading zeros followed by 8 bits of conversion data followed by four trailing zeros that are provided MSB first.
SCLK	Serial Clock. Logic input. SCLK provides the serial clock for accessing data from the part. This clock input is also used as the clock source for the conversion process of AD7476A/AD7477A/AD7478A .
NC	No Connect.

TYPICAL PERFORMANCE CHARACTERISTICS

Figure 7, Figure 8, and Figure 9 each show a typical FFT plot for the AD7476A, AD7477A, and AD7478A, respectively, at a 1 MSPS sample rate and 100 kHz input frequency. Figure 10 shows the signal-to-noise-and-distortion ratio performance vs. the input frequency for various supply voltages while sampling at 1 MSPS with an SCLK frequency of 20 MHz for the AD7476A.

Figure 11 and Figure 12 show INL and DNL performance for the AD7476A. Figure 13 shows a graph of the total harmonic distortion vs. the analog input frequency for different source impedances when using a supply voltage of 3.6 V and sampling at a rate of 1 MSPS (see the Analog Input section). Figure 14 shows a graph of the total harmonic distortion vs. the analog input signal frequency for various supply voltages while sampling at 1 MSPS with an SCLK frequency of 20 MHz.



Figure 7. AD7476A Dynamic Performance at 1 MSPS



Figure 9. AD7478A Dynamic Performance at 1 MSPS



Figure 8. AD7477A Dynamic Performance at 1 MSPS



Figure 10. AD7476A SINAD vs. Input Frequency at 1 MSPS



Figure 11. AD7476A INL Performance



Figure 12. AD7476A DNL Performance



Figure 13. THD vs. Analog Input Frequency for Various Source Impedances



Figure 14. THD vs. Analog Input Frequency for Various Supply Voltages

TERMINOLOGY

Integral Nonlinearity (INL)

INL is the maximum deviation from a straight line passing through the endpoints of the ADC transfer function. For the [AD7476A/AD7477A/AD7478A](#), the endpoints of the transfer function are zero scale (1 LSB below the first code transition), and full scale (1 LSB above the last code transition).

Differential Nonlinearity (DNL)

DNL is the difference between the measured and the ideal 1 LSB change between any two adjacent codes in the ADC.

Offset Error

This is the deviation of the first code transition (00 . . . 000) to (00 . . . 001) from the ideal, that is, AGND + 1 LSB.

Gain Error

This is the deviation of the last code transition (111 . . . 110) to (111 . . . 111) from the ideal, that is, $V_{REF} - 1$ LSB after the offset error has been adjusted out.

Track-and-Hold Acquisition Time

The track-and-hold amplifier returns to track mode at the end of a conversion. The track-and-hold acquisition time is the time required for the output of the track-and-hold amplifier to reach its final value, within 0.5 LSB, after the end of conversion. See the Serial Interface section for more details.

Signal-to-Noise-and-Distortion-Ratio (SINAD)

This is the measured ratio of signal-to-noise-and-distortion at the output of the ADC. The signal is the rms amplitude of the fundamental. Noise is the sum of all nonfundamental signals up to half the sampling frequency ($f_s/2$), excluding dc. The ratio is dependent on the number of quantization levels in the digitization process; the more levels, the smaller the quantization noise. The theoretical signal-to-noise-and-distortion ratio for an ideal N-bit converter with a sine wave input is given by signal-to-noise-and-distortion = $(6.02 N + 1.76)$ dB. Thus, it is 74 dB for a 12-bit converter, 62 dB for a 10-bit converter, and 50 dB for an 8-bit converter.

Total Unadjusted Error (TUE)

This is a comprehensive specification that includes the gain, linearity, and offset errors.

Total Harmonic Distortion (THD)

Total harmonic distortion is the ratio of the rms sum of harmonics to the fundamental. It is defined as

$$THD(\text{dB}) = 20 \log \frac{\sqrt{V_2^2 + V_3^2 + V_4^2 + V_5^2 + V_6^2}}{V_1}$$

where V_1 is the rms amplitude of the fundamental, and V_2 , V_3 , V_4 , V_5 , and V_6 are the rms amplitudes of the second through the sixth harmonics.

Peak Harmonic or Spurious Noise (SFDR)

Peak harmonic or spurious noise is defined as the ratio of the rms value of the next largest component in the ADC output spectrum (up to $f_s/2$ and excluding dc) to the rms value of the fundamental. Normally, the value of this specification is determined by the largest harmonic in the spectrum. For ADCs where the harmonics are buried in the noise floor, it is a noise peak.

Intermodulation Distortion (IMD)

With inputs consisting of sine waves at two frequencies, f_a and f_b , any active device with nonlinearities create distortion products at sum and difference frequencies of $m f_a$, $n f_b$, where m and $n = 0, 1, 2, 3$, and so on. Intermodulation distortion terms are those for which neither m nor n are equal to zero. For example, the second-order terms include $(f_a + f_b)$ and $(f_a - f_b)$, and the third-order terms include $(2f_a + f_b)$, $(2f_a - f_b)$, $(f_a + 2f_b)$, and $(f_a - 2f_b)$.

The [AD7476A/AD7477A/AD7478A](#) are tested using the CCIF standard where two input frequencies are used (see f_a and f_b in the Specifications section). In this case, the second-order terms are usually distanced in frequency from the original sine waves, while the third-order terms are usually at a frequency close to the input frequencies. As a result, the second- and third-order terms are specified separately. The calculation of the intermodulation distortion is per the THD specification, where it is the ratio of the rms sum of the individual distortion products to the rms amplitude of the sum of the fundamentals expressed in decibels.

THEORY OF OPERATION

CIRCUIT INFORMATION

The AD7476A/AD7477A/AD7478A are fast, micropower, 12-/10-/8-bit, single-supply analog-to-digital converters (ADCs), respectively. The parts can be operated from a 2.35 V to 5.25 V supply. When operated from either a 5 V supply or a 3 V supply, the AD7476A/AD7477A/AD7478A are capable of throughput rates of 1 MSPS when provided with a 20 MHz clock. The AD7476A/AD7477A/AD7478A provide the user with an on-chip, track-and-hold ADC and a serial interface housed in a tiny 6-lead SC70 package or in an 8-lead MSOP, offering the user considerable space-saving advantages over alternative solutions. The serial clock input accesses data from the part but also provides the clock source for the successive-approximation ADC. The analog input range is 0 V to V_{DD} . The ADC does not require an external reference or an on-chip reference. The reference for the AD7476A/AD7477A/AD7478A is derived from the power supply and, thus, gives the widest dynamic input range. The AD7476A/AD7477A/AD7478A also feature a power-down option to allow power saving between conversions. The power-down feature is implemented across the standard serial interface, as described in the Modes of Operation section.

THE CONVERTER OPERATION

AD7476A/AD7477A/AD7478A are successive approximation, analog-to-digital converters based around a charge redistribution DAC. Figure 15 and Figure 16 show simplified schematics of the ADC. Figure 15 shows the ADC during its acquisition phase. SW2 is closed and SW1 is in Position A, the comparator is held in a balanced condition, and the sampling capacitor acquires the signal on V_{IN} .



Figure 15. ADC Acquisition Phase

When the ADC starts a conversion (see Figure 16), SW2 opens and SW1 moves to Position B, causing the comparator to become unbalanced. The control logic and the charge redistribution DAC are used to add and subtract fixed amounts of charge from the sampling capacitor to bring the comparator back into a balanced condition. When the comparator is rebalanced, the conversion is complete. The control logic generates the ADC output code. Figure 17 shows the ADC transfer function.



Figure 16. ADC Conversion Phase

ADC TRANSFER FUNCTION

The output coding of the AD7476A/AD7477A/AD7478A is straight binary. The designed code transitions occur at the successive integer LSB values, that is, 1 LSB, 2 LSB, and so on. The LSB size is $V_{DD}/4096$ for the AD7476A, $V_{DD}/1024$ for the AD7477A, and $V_{DD}/256$ for the AD7478A. The ideal transfer characteristic for the AD7476A/AD7477A/AD7478A is shown in Figure 17.



Figure 17. AD7476A/AD7477A/AD7478A Transfer Characteristic

TYPICAL CONNECTION DIAGRAM

Figure 18 shows a typical connection diagram for the AD7476A/AD7477A/AD7478A. V_{REF} is taken internally from V_{DD} and, as such, V_{DD} should be well decoupled. This provides an analog input range of 0 V to V_{DD} . The conversion result is output in a 16-bit word with four leading zeros followed by the MSB of the 12-bit, 10-bit, or 8-bit result. The 10-bit result from the AD7477A is followed by two trailing zeros, and the 8-bit result from the AD7478A is followed by four trailing zeros. Alternatively, because the supply current required by the AD7476A/AD7477A/AD7478A is so low, a precision reference can be used as the supply source to the AD7476A/AD7477A/AD7478A. A REF193/REF195 voltage reference (REF193 for 3 V or REF195 for 5 V) can be used to supply the required voltage to the ADC (see Figure 18). This configuration is especially useful if the power supply is quite noisy, or if the system supply voltages are at some value other than 5 V or 3 V (for example, 1.5 V).

The REF193/REF195 output a steady voltage to the AD7476A/AD7477A/AD7478A. If the low dropout REF193 is used, the current it needs to supply to the AD7476A/AD7477A/AD7478A is typically 1.2 mA. When the ADC is converting at a rate of 1 MSPS, the REF193 needs to supply a maximum of 1.7 mA to the AD7476A/AD7477A/AD7478A. The load regulation of the REF193 is typically 10 ppm/mA ($V_s = 5$ V), resulting in an error of 17 ppm (51 μ V) for the 1.7 mA drawn from it. This corresponds to a 0.069 LSB error for the AD7476A with $V_{DD} = 3$ V from the REF193, a 0.017 LSB error for the AD7477A, and a 0.0043 LSB error for the AD7478A.

For applications where power consumption is a concern, use the power-down mode of the ADC and the sleep mode of the REF193/REF195 reference to improve power performance. See the Modes of Operation section.



Figure 18. REF193 as Power Supply to AD7476A/AD7477A/AD7478A

Table 7 provides typical performance data with various references used as a V_{DD} source for a 100 kHz input tone at room temperature under the same setup conditions.

Table 7. AD7476A Typical Performance for Various Voltage References

Reference Tied to V_{DD}	AD7476A SNR Performance (dB)
AD780 at 3 V	72.65
REF193	72.35
AD780 at 2.5 V	72.5
REF192	72.2
REF43	72.6

ANALOG INPUT

Figure 19 shows an equivalent circuit of the analog input structure of the AD7476A/AD7477A/AD7478A. The two diodes, D1 and D2, provide ESD protection for the analog input. Ensure that the analog input signal never exceeds the supply rails by more than 300 mV. This causes the diodes to become forward-biased and start conducting current into the substrate. The maximum current these diodes can conduct without causing irreversible damage to the part is 10 mA. The Capacitor C1 in Figure 19 is typically about 6 pF and can primarily be attributed to pin capacitance. The Resistor R1 is a lumped component made up of the on resistance of a switch. This resistor is typically about 100 Ω . The Capacitor C2 is the ADC sampling capacitor and has a capacitance of 20 pF typically.

For ac applications, removing high frequency components from the analog input signal is recommended by use of a band-pass filter on the relevant analog input pin. In applications where harmonic distortion and signal-to-noise ratio are critical, drive the analog input from a low impedance source. Large source impedances significantly affect the ac performance of the ADC, necessitating the use of an input buffer amplifier. The choice of the op amp is a function of the particular application.

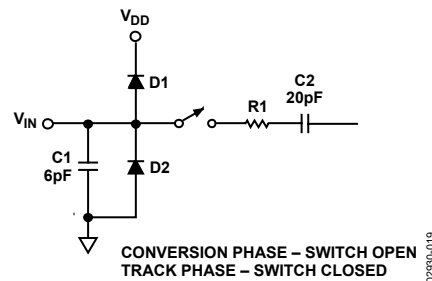

Figure 19. Equivalent Analog Input Circuit

Table 8 provides typical performance data with various op amps used as the input buffer for a 100 kHz input tone at room temperature under the same setup conditions.

Table 8. AD7476A Typical Performance with Various Input Buffers, $V_{DD} = 3\text{ V}$

Op Amp in the Input Buffer	AD7476A SNR Performance (dB)
AD711	72.3
AD797	72.5
AD845	71.4

When no amplifier is used to drive the analog input, limit the source impedance to low values. The maximum source impedance depends on the amount of total harmonic distortion (THD) that can be tolerated. The THD increases as the source impedance increases, degrading the performance (see Figure 13).

DIGITAL INPUTS

The digital inputs applied to the [AD7476A/AD7477A/AD7478A](#) are not limited by the maximum ratings that limit the analog input. Instead, the digital inputs applied can reach 7 V and are not restricted by the $V_{DD} + 0.3\text{ V}$ limit as on the analog input. For example, if operating the [AD7476A/AD7477A/AD7478A](#) with a V_{DD} of 3 V, use 5 V logic levels on the digital inputs. However, note that the data output on SDATA still has 3 V logic levels when $V_{DD} = 3\text{ V}$. Another advantage of SCLK and $\overline{\text{CS}}$ not being restricted by the $V_{DD} + 0.3\text{ V}$ limit is that power supply sequencing issues are avoided. If $\overline{\text{CS}}$ or SCLK are applied before V_{DD} , there is no risk of latch-up as there would be on the analog input if a signal greater than 0.3 V were applied prior to V_{DD} .

MODES OF OPERATION

The modes of operation for the [AD7476A/AD7477A/AD7478A](#) are selected by controlling the (logic) state of the $\overline{\text{CS}}$ signal during a conversion. There are two possible modes of operation: normal and power-down. The point at which $\overline{\text{CS}}$ is pulled high after the conversion has been initiated determines whether the [AD7476A/AD7477A/AD7478A](#) enters power-down mode. Similarly, if already in power-down, $\overline{\text{CS}}$ can control whether the device returns to normal operation or remains in power-down. These modes of operation are designed to provide flexible power management options. These options can be chosen to optimize the power dissipation/throughput rate ratio for different application requirements.

NORMAL MODE

This mode is intended for the fastest throughput rate performance. In normal mode, the user does not have to worry about any power-up times because [AD7476A/AD7477A/AD7478A](#) remain fully powered at all times. Figure 20 shows the general diagram of the operation of the [AD7476A/AD7477A/AD7478A](#) in this mode. The conversion is initiated on the falling edge of $\overline{\text{CS}}$ as described in the Serial Interface section. To ensure that the part remains fully powered up at all times, $\overline{\text{CS}}$ must remain low until at least 10 SCLK falling edges have elapsed after the falling edge of $\overline{\text{CS}}$. If $\overline{\text{CS}}$ is brought high any time after the 10th SCLK falling edge but before the end of the t_{CONVERT} , the part remains powered up, but the conversion is terminated and SDATA goes back into three-state. For the [AD7476A](#), 16 serial clock cycles are required to complete the conversion and access the complete conversion results. For the [AD7477A](#) and [AD7478A](#), a minimum of 14 and 12 serial clock cycles are required to complete the conversion and access the complete conversion results, respectively. $\overline{\text{CS}}$ can idle high until the next conversion or idle low until $\overline{\text{CS}}$ returns high sometime prior to the next conversion (effectively idling $\overline{\text{CS}}$ low). Once a data transfer is complete (SDATA has returned to three-state), another conversion can be initiated after the quiet time, t_{QUIET} , has elapsed by bringing $\overline{\text{CS}}$ low again.

POWER-DOWN MODE

This mode is intended for use in applications where slower throughput rates are required; either the ADC is powered down between each conversion, or a series of conversions is performed at a high throughput rate and the ADC is then powered down for a relatively long duration between these bursts of several conversions. When the [AD7476A/AD7477A/AD7478A](#) are in power-down, all analog circuitry is powered down. To enter power-down, the conversion process must be interrupted by bringing $\overline{\text{CS}}$ high anywhere after the second falling edge of SCLK and before the 10th falling edge of SCLK, as shown in Figure 22.

Once $\overline{\text{CS}}$ has been brought high in this window of SCLKs, the part enters power-down, the conversion that was initiated by the falling edge of $\overline{\text{CS}}$ is terminated, and SDATA goes back into three-state. If $\overline{\text{CS}}$ is brought high before the second SCLK falling edge, the part remains in normal mode and does not power down. This avoids accidental power-down due to glitches on the $\overline{\text{CS}}$ line. In order to exit this mode of operation and power up the [AD7476A/AD7477A/AD7478A](#) again, a dummy conversion is performed. On the falling edge of $\overline{\text{CS}}$, the device begins to power up and continues to power up as long as $\overline{\text{CS}}$ is held low until after the falling edge of the 10th SCLK. The device is fully powered up once 16 SCLKs have elapsed, and valid data results from the next conversion, as shown in Figure 24. If $\overline{\text{CS}}$ is brought high before the 10th falling edge of SCLK, then the [AD7476A/AD7477A/AD7478A](#) go back into power-down. This avoids accidental power-up due to glitches on the $\overline{\text{CS}}$ line or an inadvertent burst of eight SCLK cycles while $\overline{\text{CS}}$ is low. Although the device can begin to power up on the falling edge of $\overline{\text{CS}}$, it powers down again on the rising edge of $\overline{\text{CS}}$ as long as it occurs before the 10th SCLK falling edge.

POWER-UP TIME

The power-up time of the [AD7476A/AD7477A/AD7478A](#) is 1 μs , meaning that with any frequency of SCLK up to 20 MHz, one dummy cycle is always sufficient to allow the device to power up. Once the dummy cycle is complete, the ADC is fully powered up and the input signal is acquired properly. The quiet time, t_{QUIET} , must still be allowed from the point where the bus goes back into three-state after the dummy conversion to the next falling edge of $\overline{\text{CS}}$. When running at a 1 MSPS throughput rate, the [AD7476A/AD7477A/AD7478A](#) power up and acquire a signal within 0.5 LSB in one dummy cycle, that is, 1 μs .

When powering up from the power-down mode with a dummy cycle, as in Figure 22, the track-and-hold that was in hold mode while the part was powered down returns to track mode after the first SCLK edge the part receives after the falling edge of $\overline{\text{CS}}$. This is shown as Point A in Figure 22. Although at any SCLK frequency, one dummy cycle is sufficient to power up the device and acquire V_{IN} , it does not necessarily mean that a full dummy cycle of 16 SCLKs must always elapse to power up the device and acquire V_{IN} fully; 1 μs is sufficient to power up the device and acquire the input signal. If, for example, a 5 MHz SCLK frequency is applied to the ADC, the cycle time becomes 3.2 μs . In one dummy cycle, 3.2 μs , the part powers up and V_{IN} acquires fully. However, after 1 μs with a 5 MHz SCLK, only five SCLK cycles would have elapsed. At this stage, the ADC would fully power up and acquire the signal. In this case, the $\overline{\text{CS}}$ can be brought high after the 10th SCLK falling edge and brought low again after a time, t_{QUIET} , to initiate the conversion.



Figure 20. Normal Mode Operation



Figure 21. Entering Power-Down Mode

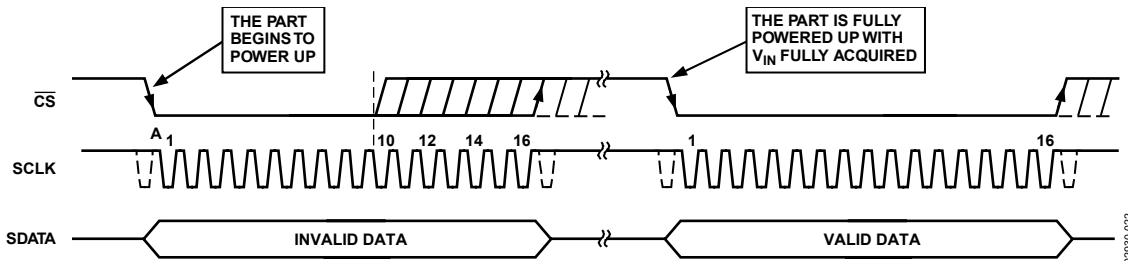

Figure 22. Exiting Power-Down Mode

When power supplies are first applied to the [AD7476A/AD7477A/AD7478A](#), the ADC can power up in either the power-down or normal modes. Because of this, it is best to allow a dummy cycle to elapse to ensure that the part is fully powered up before attempting a valid conversion. Likewise, if it is intended to keep the part in the power-down mode while not in use and the user wishes the part to power up in power-down mode, the dummy cycle can be used to ensure that the device is in power-down by executing a cycle such as that shown in Figure 22. Once supplies are applied to the [AD7476A/AD7477A/AD7478A](#), the power-up time is the same as that when powering up from the power-down mode. It takes approximately 1 μ s to power up fully if the part powers up in normal mode. It is not necessary to wait 1 μ s before executing a dummy cycle to ensure the desired mode of operation.

Instead, a dummy cycle can occur directly after power is supplied to the ADC. If the first valid conversion is performed directly after the dummy conversion, ensure that an adequate acquisition time has been allowed. As mentioned earlier, when powering up from the power-down mode, the part returns to track upon the first SCLK edge applied after the falling edge of \overline{CS} . However, when the ADC initially powers up after supplies are applied, the track-and-hold is already in track. This means, assuming one has the facility to monitor the ADC supply current, if the ADC powers up in the desired mode of operation and thus a dummy cycle is not required to change the mode, a dummy cycle is not required to place the track-and-hold into track.

POWER VS. THROUGHPUT RATE

By using the power-down mode on the [AD7476A/AD7477A/AD7478A](#) when not converting, the average power consumption of the ADC decreases at lower throughput rates. Figure 23 shows that as the throughput rate is reduced, the device remains in its power-down state longer and the average power consumption over time drops accordingly.

For example, if the [AD7476A/AD7477A/AD7478A](#) operate in a continuous sampling mode with a throughput rate of 100 kSPS and an SCLK of 20 MHz ($V_{DD} = 5\text{ V}$) and the devices are placed in the power-down mode between conversions, the power consumption is calculated as follows:

The power dissipation during normal operation is 17.5 mW ($V_{DD} = 5\text{ V}$). If the power-up time is one dummy cycle, that is, 1 μs , and the remaining conversion time is another cycle, that is, 1 μs , then the [AD7476A/AD7477A/AD7478A](#) dissipate 17.5 mW for 2 μs during each conversion cycle.

If the throughput rate is 100 kSPS, the cycle time is 10 μs , then the average power dissipated during each cycle is $(2/10) \times (17.5\text{ mW}) = 3.5\text{ mW}$.

If $V_{DD} = 3\text{ V}$, SCLK = 20 MHz, and the devices are again in power-down mode between conversions, then the power dissipation during normal operation is 5.1 mW. Thus, the [AD7476A/AD7477A/AD7478A](#) dissipate 5.1 mW for 2 μs during each conversion cycle. With a throughput rate of 100 kSPS, the average power dissipated during each cycle is $(2/10) \times (5.1\text{ mW}) = 1.02\text{ mW}$.

Figure 23 shows the power vs. the throughput rate when using the power-down mode between conversions with both 5 V and 3 V supplies. The power-down mode is intended for use with throughput rates of approximately 333 kSPS or less, because at higher sampling rates, the power-down mode produces no power savings.

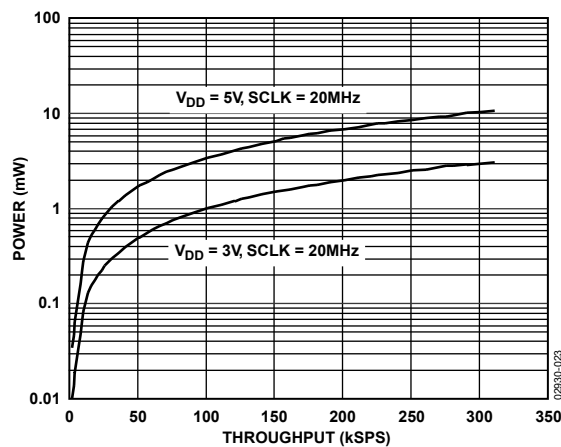

Figure 23. Power vs. Throughput

SERIAL INTERFACE

Figure 24, Figure 25, and Figure 26 show the detailed timing diagrams for serial interfacing to the AD7476A, AD7477A, and AD7478A, respectively. The serial clock provides the conversion clock and also controls the transfer of information from the AD7476A/AD7477A/AD7478A during conversion.

The \overline{CS} signal initiates the data transfer and conversion process. The falling edge of \overline{CS} puts the track-and-hold into hold mode and takes the bus out of three-state; the analog input is sampled at this point. Also, the conversion is initiated at this point.

For the AD7476A, the conversion requires 16 SCLK cycles to complete. Once 13 SCLK falling edges have elapsed, the track-and-hold goes back into track on the next SCLK rising edge, as shown in Figure 24 at Point B. On the 16th SCLK falling edge, the SDATA line goes back into three-state. If the rising edge of \overline{CS} occurs before 16 SCLKs have elapsed, the conversion is terminated and the SDATA line goes back into three-state; otherwise, SDATA returns to three-state on the 16th SCLK

falling edge, as shown in Figure 24. Sixteen serial clock cycles are required to perform the conversion process and to access data from the AD7476A.

For the AD7477A, the conversion requires 14 SCLK cycles to complete. Once 13 SCLK falling edges have elapsed, the track-and-hold goes back into track on the next rising edge as shown at Point B in Figure 25. If the rising edge of \overline{CS} occurs before 14 SCLKs have elapsed, the conversion is terminated and the SDATA line goes back into three-state. If 16 SCLKs are considered in the cycle, SDATA returns to three-state on the 16th SCLK falling edge, as shown in Figure 25.

For the AD7478A, the conversion requires 12 SCLK cycles to complete. The track-and-hold goes back into track on the rising edge after the 11th falling edge, as shown in Figure 26 at Point B. If the rising edge of \overline{CS} occurs before 12 SCLKs have elapsed, the conversion is terminated and the SDATA line goes back into three-state. If 16 SCLKs are considered in the cycle, SDATA returns to three-state on the 16th SCLK falling edge, as shown in Figure 26.

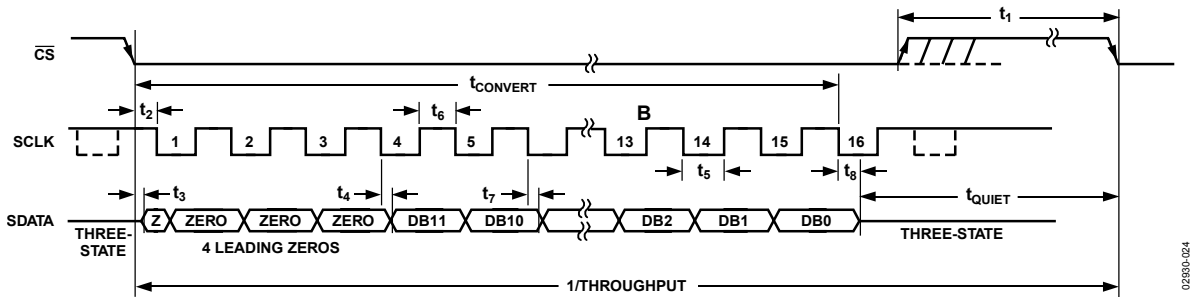

Figure 24. AD7476A Serial Interface Timing Diagram

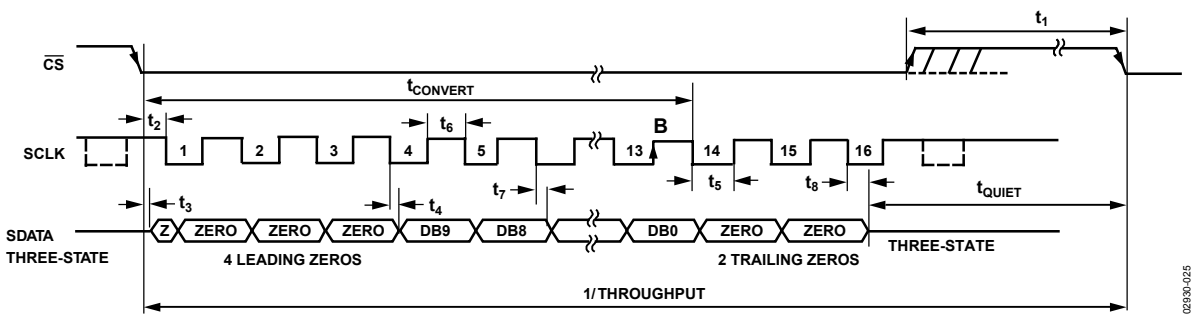

Figure 25. AD7477A Serial Interface Timing Diagram



Figure 26. AD7478A Serial Interface Timing Diagram

\overline{CS} going low clocks out the first leading zero to be read in by the microcontroller or DSP. The remaining data is then clocked out by subsequent SCLK falling edges beginning with the second leading zero. Thus, the first falling clock edge on the serial clock has the first leading zero provided and also clocks out the second leading zero. For the AD7476A, the final bit in the data transfer is valid on the 16th falling edge, having been clocked out on the previous (15th) falling edge.

In applications with a slower SCLK, it is possible to read in data on each SCLK rising edge. In this case, the first falling edge of SCLK clocks out the second leading zero, which can be read in the first rising edge. However, the first leading zero that was clocked out when \overline{CS} went low will be missed, unless it was not read in the first falling edge. The 15th falling edge of SCLK clocks out the last bit and it can be read in the 15th rising SCLK edge.

If \overline{CS} goes low just after one SCLK falling edge has elapsed, \overline{CS} clocks out the first leading zero as it did before, and it can be read in the SCLK rising edge. The next SCLK falling edge clocks out the second leading zero, and it can be read in the following rising edge.

AD7478A IN A 12 SCLK CYCLE SERIAL INTERFACE

For the AD7478A, if \overline{CS} is brought high in the 12th rising edge after four leading zeros and eight bits of the conversion have been provided, the part can achieve a 1.2 MSPS throughput rate. For the AD7476A, the track-and-hold goes back into track in the 11th rising edge. In this case, a $f_{SCLK} = 20$ MHz and a throughput of 1.2 MSPS give a cycle time of

$$t_2 + 10.5(1/f_{SCLK}) + t_{ACQ} = 833 \text{ ns}$$

With $t_2 = 10$ ns min, this leaves t_{ACQ} to be 298 ns. This 298 ns satisfies the requirement of 225 ns for t_{ACQ} .

From Figure 27, t_{ACQ} is comprised of

$$0.5(1/f_{SCLK}) + t_8 + t_{QUIET}$$

where $t_8 = 36$ ns maximum.

This allows a value of 237 ns for t_{QUIET} , satisfying the minimum requirement of 50 ns.



Figure 27. AD7478A in a 12 SCLK Cycle Serial Interface

MICROPROCESSOR INTERFACING

The serial interface on the [AD7476A/AD7477A/AD7478A](#) allows the part to be connected directly to a range of different microprocessors. This section explains how to interface the [AD7476A/AD7477A/AD7478A](#) with some of the more common microcontroller and DSP serial interface protocols.

AD7476A/AD7477A/AD7478A TO ADSP-2181 INTERFACE

The [ADSP-2181](#) and other DSPs in its family are interfaced directly to the [AD7476A/AD7477A/AD7478A](#) without any glue logic required. Set up the SPORT control register as follows:

TFSW = RFSW = 1, alternate framing
 INVRFS = INVTFS = 1, active low frame signal
 DTYPE = 00, right justify data
 ISCLK = 1, internal serial clock
 TFSR = RFSR = 1, frame every word
 IRFS = 0, sets up RFS as an input
 ITFS = 1, sets up TFS as an output
 SLEN = 1111, 16 bits for the [AD7476A](#)
 SLEN = 1101, 14 bits for the [AD7477A](#)
 SLEN = 1011, 12 bits for the [AD7478A](#)

To implement the power-down mode, set SLEN to 0111 to issue an 8-bit SCLK burst. The connection diagram is shown in Figure 28. The [ADSP-2181](#) has the TFS and RFS of the SPORT tied together, with TFS set as an output and RFS set as an input. The DSP operates in alternate framing mode, and the SPORT control register is set up as described. The frame synchronization signal generated on the TFS is tied to \overline{CS} , and, as with all signal processing applications, equidistant sampling is necessary. However, in this example, the timer interrupt is used to control the sampling rate of the ADC and, under certain conditions, equidistant sampling may not be achieved.



¹ADDITIONAL PINS OMITTED FOR CLARITY.

Figure 28. Interfacing to the [ADSP-2181](#)

The timer registers, for example, are loaded with a value that provides an interrupt at the required sample interval. When an interrupt is received, a value is transmitted with TFS/DT (ADC control word). The TFS controls the RFS and, thus, the reading of data. The frequency of the serial clock is set in the SCLKDIV register. When the instruction to transmit with TFS is given, that is, TX0 = AX0, the state of the SCLK is checked. The DSP waits until the SCLK has gone high, low, and high before transmission starts. If the timer and SCLK values are chosen such that the instruction to transmit occurs on or near the rising edge of SCLK, the data can be transmitted or it can wait until the next clock edge. For example, the [ADSP-2111](#) has a master clock frequency of 16 MHz. If the SCLKDIV register is loaded with the Value 3, an SCLK of 2 MHz is obtained and eight master clock periods will elapse for every one SCLK period. If the timer registers are loaded with the Value 803, 100.5 SCLKs occur between interrupts and, subsequently, between transmit instructions. This situation results in nonequidistant sampling as the transmit instruction is occurring on an SCLK edge. If the number of SCLKs between interrupts is a whole integer figure of N, equidistant sampling is implemented by the DSP.

AD7476A/AD7477A/AD7478A TO DSP563xx INTERFACE

The connection diagram in Figure 29 shows how the AD7476A/AD7477A/AD7478A can be connected to the SSI (synchronous serial interface) of the DSP563xx family of DSPs from Motorola. The SSI is operated in synchronous and normal mode (SYN = 1 and MOD = 0 in Control Register B, CRB) with internally generated word length frame sync for both Tx and Rx (Bit FSL1 = 0 and Bit FSL0 = 0 in CRB). Set the word length in Control Register A (CRA) to 16 by setting Bit WL2 = 0, Bit WL1 = 1, and Bit WL0 = 0 for the AD7476A. The word length for the AD7478A can be set to 12 bits (WL2 = 0, WL1 = 0, and WL0 = 1). This DSP does not offer the option for a 14-bit word length, so the AD7477A word length is set up to 16 bits, the same as the AD7476A. For the AD7477A the conversion process uses 16 SCLK cycles, with the last two clock periods clocking out two trailing zeros to fill the 16-bit word.

To implement the power-down mode on the AD7476A/AD7477A/AD7478A, the word length can be changed to eight bits by setting Bit WL2 = 0, Bit WL1 = 0, and Bit WL0 = 0 in CRA. The FSP bit in the CRB register can be set to 1, meaning the frame goes low and a conversion starts. Likewise, by means of the Bit SCD2, Bit SCKD, and Bit SHFD in the CRB register, it establishes that Pin SC2 (the frame sync signal) and Pin SCK in the serial port are configured as outputs and the MSB is shifted first.

In summary:

MOD = 0

SYN = 1

WL2, WL1, and WL0 depend on the word length

FSL1 = 0 and FSL0 = 0

FSP = 1, negative frame sync

SCD2 = 1

SCKD = 1

SHFD = 0

Note that for signal processing applications, it is imperative that the frame synchronization signal from the DSP563xx provide equidistant sampling.

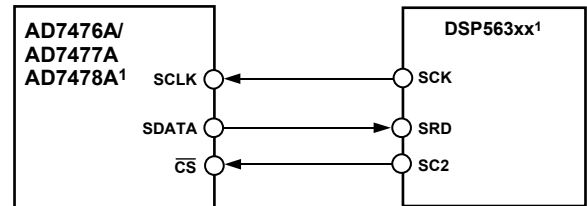

¹ADDITIONAL PINS OMITTED FOR CLARITY.

029330-030

Figure 29. Interfacing to the DSP563xx

APPLICATION HINTS

GROUNDING AND LAYOUT

Design the printed circuit board that houses the [AD7476A/AD7477A/AD7478A](#) such that the analog and digital sections are separated and confined to certain areas of the board. This facilitates the use of ground planes that can be separated easily. A minimum etch technique is generally best for ground planes because it gives the best shielding. Join digital and analog ground planes at only one place. If the [AD7476A/AD7477A/AD7478A](#) is in a system where multiple devices require an AGND to DGND connection, make the connection at one point only, a star ground point that is established as close as possible to the [AD7476A/AD7477A/AD7478A](#).

Avoid running digital lines under the device as these couple noise onto the die. Allow the analog ground plane to run under the [AD7476A/AD7477A/AD7478A](#) in order to avoid noise coupling. Use as large a trace as possible on the power supply lines to the [AD7476A/AD7477A/AD7478A](#) to provide low impedance paths and reduce the effects of glitches on the power supply line. Shield fast switching signals like clocks with digital grounds to avoid radiating noise to other sections of the board, and never run clock signals near the analog inputs. Avoid crossover of digital and analog signals. Run traces on opposite sides of the board at right angles to each other. This reduces the effects of feedthrough through the board. A microstrip technique is by far the best but is not always possible with a double-sided board. In this technique, the component side of the board is dedicated to ground planes while signals are placed on the solder side.

Good decoupling is also very important. Decouple the supply with, for instance, a 680 nF 0805 capacitor to GND. When using the SC70 package in applications where the size of the components is of concern, a 220 nF 0603 capacitor, for example, can be used instead. However, in that case, the decoupling may not be as effective, resulting in an approximate SINAD degradation of 0.3 dB. To achieve the best performance from these decoupling components, the user should endeavor to keep the distance between the decoupling capacitor and the V_{DD} and GND pins to a minimum with short track lengths connecting the respective pins. Figure 30 and Figure 31 and show the recommended positions of the decoupling capacitor for the SC70 package and MSOP, respectively.

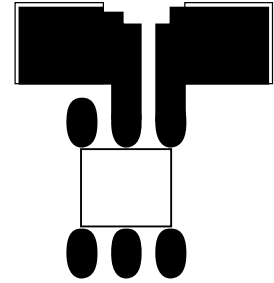

Figure 30. Recommended Supply Decoupling Scheme for the SC70 Package

As can be seen in Figure 31, for the MSOP, the decoupling capacitor has been placed as close as possible to the IC with short track lengths to V_{DD} and GND pins. The decoupling capacitor can also be placed on the underside of the PCB directly underneath the IC, between the V_{DD} and GND pins attached by vias. This method is not recommended on PCBs above a standard 1.6 mm thickness. The best performance is realized with the decoupling capacitor on the top of the PCB next to the IC.

Similarly, for the SC70 package, locate the decoupling capacitor as close as possible to the V_{DD} and the GND pins. Because of its pinout, that is, V_{DD} being next to GND, the decoupling capacitor can be placed extremely close to the IC. The decoupling capacitor can be placed on the underside of the PCB directly under the V_{DD} and GND pins, but the best performance is achieved with the decoupling capacitor on the same side as the IC.

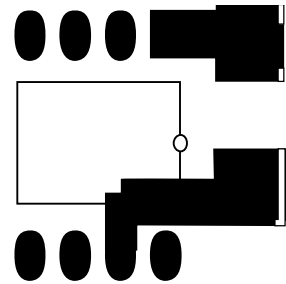

Figure 31. Recommended Supply Decoupling Scheme for the [AD7476A/AD7477A/AD7478A](#) MSOP

OUTLINE DIMENSIONS



COMPLIANT TO JEDEC STANDARDS MO-203-AB

Figure 32. 6-Lead Thin Shrink Small Outline Transistor Package [SC70] (KS-6)

Dimensions shown in millimeters



COMPLIANT TO JEDEC STANDARDS MO-187-AA

Figure 33. 8-Lead Mini Small Outline Package [MSOP] (RM-8)

Dimensions shown in millimeters

ORDERING GUIDE

Model ^{1, 2}	Temperature Range	Linearity Error (LSB) ³	Package Description	Package Option ⁴	Branding
AD7476AAKSZ-500RL7	-40°C to +85°C	±0.75 typical	6-Lead SC70	KS-6	C3V
AD7476AAKSZ-REEL7	-40°C to +85°C	±0.75 typical	6-Lead SC70	KS-6	C3V
AD7476ABKSZ-500RL7	-40°C to +85°C	±1.5 maximum	6-Lead SC70	KS-6	C3W
AD7476ABKSZ-REEL7	-40°C to +85°C	±1.5 maximum	6-Lead SC70	KS-6	C3W
AD7476ABRM	-40°C to +85°C	±1.5 maximum	8-Lead MSOP	RM-8	CEY
AD7476ABRM-REEL7	-40°C to +85°C	±1.5 maximum	8-Lead MSOP	RM-8	CEY
AD7476ABRMZ	-40°C to +85°C	±1.5 maximum	8-Lead MSOP	RM-8	C3W
AD7476ABRMZ-REEL	-40°C to +85°C	±1.5 maximum	8-Lead MSOP	RM-8	C3W
AD7476ABRMZ-REEL7	-40°C to +85°C	±1.5 maximum	8-Lead MSOP	RM-8	C3W
AD7476AWYRMZ	-40°C to +125°C	±1.5 maximum	8-Lead MSOP	RM-8	C45
AD7476AWYRMZ-RL7	-40°C to +125°C	±1.5 maximum	8-Lead MSOP	RM-8	C45
AD7476AYKSZ-500RL7	-40°C to +125°C	±1.5 maximum	6-Lead SC70	KS-6	C45
AD7476AYKSZ-REEL7	-40°C to +125°C	±1.5 maximum	6-Lead SC70	KS-6	C45
AD7476AYRMZ	-40°C to +125°C	±1.5 maximum	8-Lead MSOP	RM-8	C45
AD7476AYRMZ-REEL7	-40°C to +125°C	±1.5 maximum	8-Lead MSOP	RM-8	C45

Model ^{1, 2}	Temperature Range	Linearity Error (LSB) ³	Package Description	Package Option ⁴	Branding
AD7477AAKSZ-500RL7	-40°C to +85°C	±0.5 maximum	6-Lead SC70	KS-6	C3X
AD7477AAKSZ-REEL	-40°C to +85°C	±0.5 maximum	6-Lead SC70	KS-6	C3X
AD7477AARMZ	-40°C to +85°C	±0.5 maximum	8-Lead MSOP	RM-8	C3X
AD7477AARMZ-REEL	-40°C to +85°C	±0.5 maximum	8-Lead MSOP	RM-8	C3X
AD7477AARMZ-REEL7	-40°C to +85°C	±0.5 maximum	8-Lead MSOP	RM-8	C3X
AD7477AWARMZ	-40°C to +85°C	±0.5 maximum	8-Lead MSOP	RM-8	C3X
AD7477AWARMZ-RL	-40°C to +85°C	±0.5 maximum	8-Lead MSOP	RM-8	C3X
AD7478AAKSZ-500RL7	-40°C to +85°C	±0.3 maximum	6-Lead SC70	KS-6	C48
AD7478AAKSZ-REEL7	-40°C to +85°C	±0.3 maximum	6-Lead SC70	KS-6	C48
AD7478AARM	-40°C to +85°C	±0.3 maximum	8-Lead MSOP	RM-8	CJZ
AD7478AARMZ	-40°C to +85°C	±0.3 maximum	8-Lead MSOP	RM-8	C48
AD7478AARMZ-REEL7	-40°C to +85°C	±0.3 maximum	8-Lead MSOP	RM-8	C48
AD7478AWARMZ	-40°C to +85°C	±0.3 maximum	8-Lead MSOP	RM-8	C48
AD7478AWARMZ-RL	-40°C to +85°C	±0.3 maximum	8-Lead MSOP	RM-8	C48

¹ Z = RoHS Compliant Part.

² W = Qualified for Automotive Applications.

³ Linearity error here refers to integral nonlinearity.

⁴ KS = SC70; RM = MSOP.

AUTOMOTIVE PRODUCTS

The [AD7476AWYRMZ](#), [AD7476AWYRMZ-RL7](#), [AD7477AWARMZ](#), [AD7477AWARMZ-RL](#), [AD7478AWARMZ](#), and [AD7478AWARMZ-RL](#) models are available with controlled manufacturing to support the quality and reliability requirements of automotive applications. Note that these automotive models may have specifications that differ from the commercial models; therefore, designers should review the Specifications section of this data sheet carefully. Only the automotive grade products shown are available for use in automotive applications. Contact your local Analog Devices account representative for specific product ordering information and to obtain the specific Automotive Reliability reports for these models.

AD7476A/AD7477A/AD7478A

NOTES

Компания «Life Electronics» занимается поставками электронных компонентов импортного и отечественного производства от производителей и со складов крупных дистрибьюторов Европы, Америки и Азии.

С конца 2013 года компания активно расширяет линейку поставок компонентов по направлению коаксиальный кабель, кварцевые генераторы и конденсаторы (керамические, пленочные, электролитические), за счёт заключения дистрибьюторских договоров

Мы предлагаем:

- Конкуренспособные цены и скидки постоянным клиентам.
- Специальные условия для постоянных клиентов.
- Подбор аналогов.
- Поставку компонентов в любых объемах, удовлетворяющих вашим потребностям.
- Приемлемые сроки поставки, возможна ускоренная поставка.
- Доставку товара в любую точку России и стран СНГ.
- Комплексную поставку.
- Работу по проектам и поставку образцов.
- Формирование склада под заказчика.
- Сертификаты соответствия на поставляемую продукцию (по желанию клиента).
- Тестирование поставляемой продукции.
- Поставку компонентов, требующих военную и космическую приемку.
- Входной контроль качества.
- Наличие сертификата ISO.

В составе нашей компании организован Конструкторский отдел, призванный помогать разработчикам, и инженерам.

Конструкторский отдел помогает осуществить:

- Регистрацию проекта у производителя компонентов.
- Техническую поддержку проекта.
- Защиту от снятия компонента с производства.
- Оценку стоимости проекта по компонентам.
- Изготовление тестовой платы монтаж и пусконаладочные работы.



Тел: +7 (812) 336 43 04 (многоканальный)

Email: org@lifeelectronics.ru