



GaAs MMIC VOLTAGE - VARIABLE ATTENUATOR, 10 - 40 GHz

Typical Applications

The HMC985LP4KE is ideal for:

- Point-to-Point Radio
- VSAT Radio
- Test Instrumentation
- Microwave Sensors
- Military, ECM & Radar

Features

- Wide Bandwidth: 10 - 40 GHz
- Excellent Linearity: +32 dB Input IP3
- Wide Attenuation Range: 35 dB
- No External Matching
- 24 Lead 4x4 mm SMT Package: 16 mm²

General Description

The HMC985LP4KE is an absorptive Voltage Variable Attenuator (VVA) which operates from 10 - 40 GHz and is ideal in designs where an analog DC control signal must be used to control RF signal levels over a 35 dB dynamic range. It features two shunt-type attenuators which are controlled by two analog voltages, Vctl1 and Vctl2. Optimum linearity performance of the attenuator is achieved by first varying Vctl1 of the first attenuation stage from -3V to 0V with Vctl2 fixed at -3V. The control voltage of the second attenuation stage, Vctl2, should then be varied from -3V to 0V with Vctl1 fixed at 0V.

if the Vctl1 and Vctl2 pins are connected together it is possible to achieve the full analog attenuation range with only a small degradation in input IP3 performance. Applications include AGC circuits and temperature compensation of multiple gain stages in microwave point-to-point and VSAT radios.

Functional Diagram

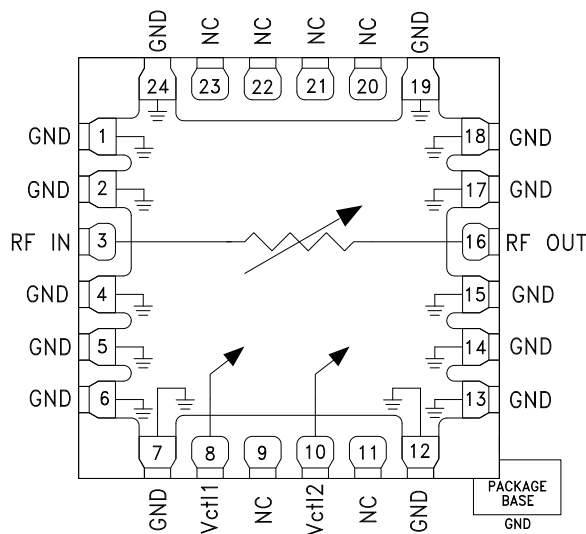

Electrical Specifications, $T_A = +25\text{ }^\circ\text{C}$, Test Condition $V_{ctl1} = V_{ctl2}$

Parameter	Frequency	Min.	Typ.	Max.	Units
Insertion Loss [1]	10 - 20 GHz		3	3.5	dB
	20 - 30 GHz		3	4	dB
	30 - 40 GHz		3.5	4.5	dB
Attenuation Range	10 - 20 GHz	25	30		dB
	20 - 30 GHz	30	35		dB
	30 - 40 GHz	35	40		dB
Input Return Loss	10 - 40 GHz		13		dB
Output Return Loss	10 - 40 GHz		13		dB
Input Third Order Intercept (two-tone input Power = 10 dBm Each Tone) [2]			33		dBm

[1] Vctl1 = Vctl2 = -2.4V

[2] Vctl1 = Vctl2 = -2.0V worst case



GaAs MMIC VOLTAGE - VARIABLE ATTENUATOR, 10 - 40 GHz

Attenuation vs. Frequency over Vctrl1 = Variable, Vctrl2 = -3V

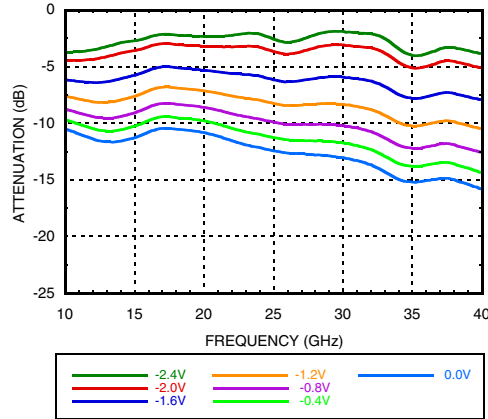

Attenuation vs. Frequency over Vctrl1 = 0V, Vctrl2 = Variable

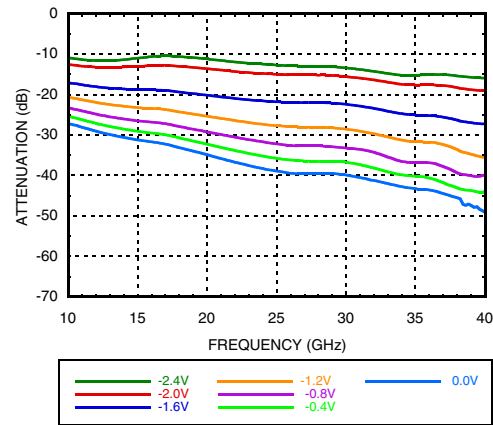

Attenuation vs. Vctrl1 Over Temperature @ 25 GHz, Vctrl2 = -3V

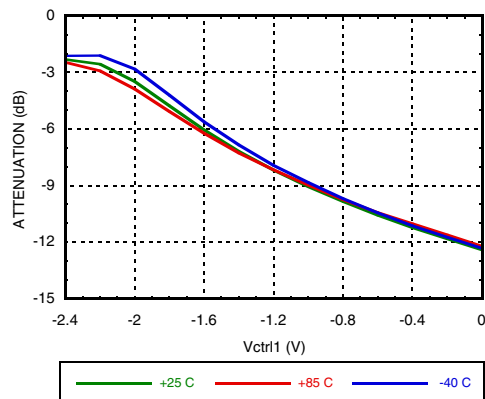

Attenuation vs. Vctrl2 Over Temperature @ 30 GHz, Vctrl1 = 0V

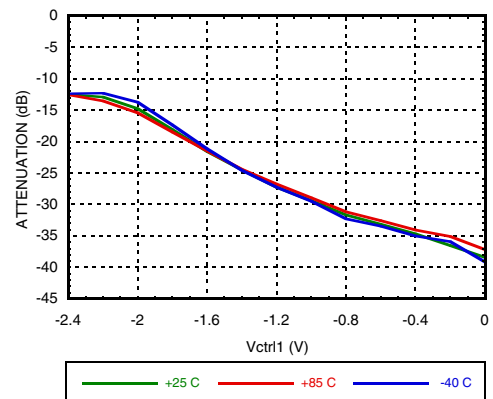

Attenuation vs. Pin @ 20 GHz over Vctrl1 Variable, Vctrl2 = -3V

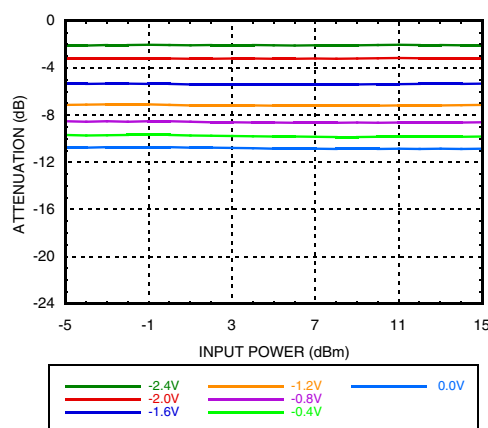

Attenuation vs. Pin @ 20 GHz over Vctrl2 Variable, Vctrl1 = 0V

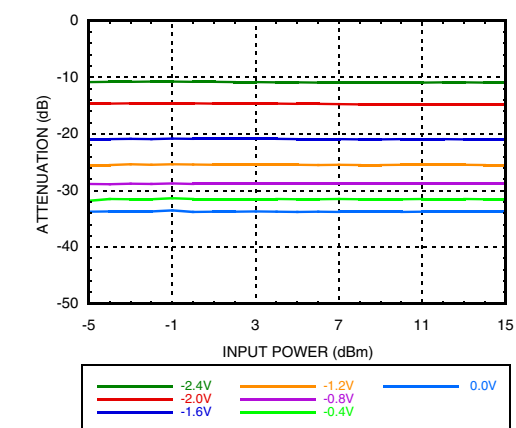

Information furnished by Analog Devices is believed to be accurate and reliable. However, no responsibility is assumed by Analog Devices for its use, nor for any infringements of patents or other rights of third parties that may result from its use. Specifications subject to change without notice. No license is granted by implication or otherwise under any patent or patent rights of Analog Devices. Trademarks and registered trademarks are the property of their respective owners.

For price, delivery, and to place orders: Analog Devices, Inc., One Technology Way, P.O. Box 9106, Norwood, MA 02062-9106 Phone: 781-329-4700 • Order online at www.analog.com Application Support: Phone: 1-800-ANALOG-D



GaAs MMIC VOLTAGE - VARIABLE ATTENUATOR, 10 - 40 GHz

Input Return Loss
Vctl1 = Variable, Vctl2 = -3V

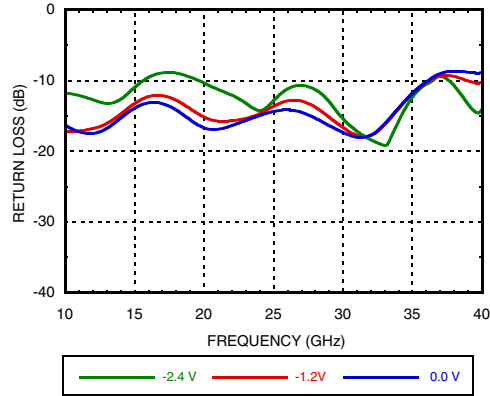

Input Return Loss
Vctl1 = 0V, Vctl2 = Variable

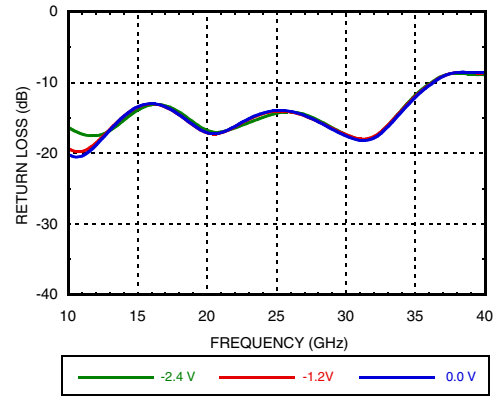

Output Return Loss
Vctl1 = Variable, Vctl2 = -3V

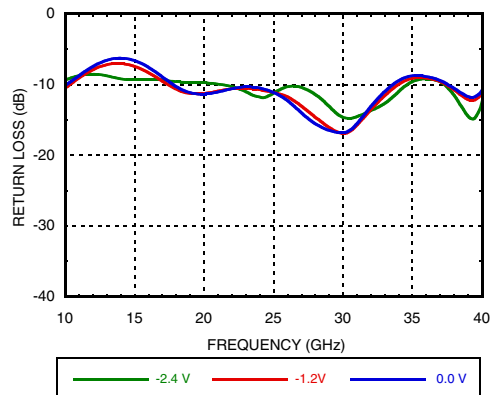

Output Return Loss
Vctl1 = 0V, Vctl2 = Variable

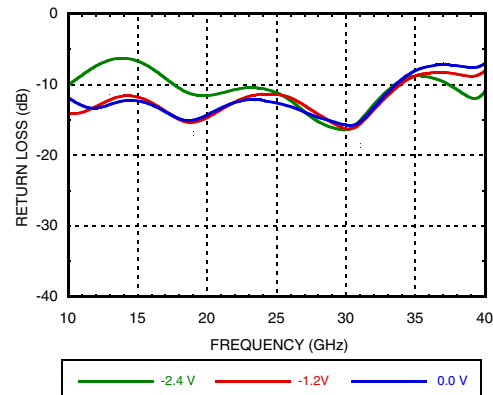

Input IP3 vs. Input Power @ 20 GHz
Vctl1 = Variable, Vctl2 = -3V

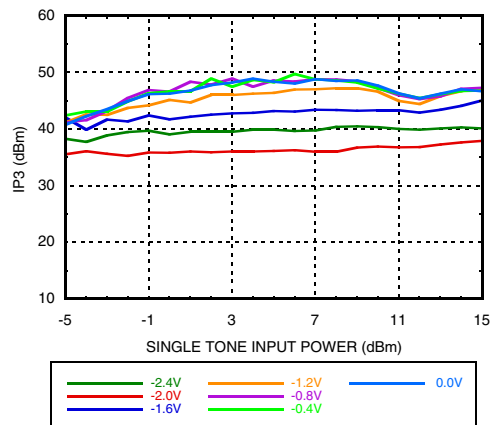

Input IP3 vs. Input Power Over Frequency
Vctl1 = -2V, Vctl2 = -3V [1]

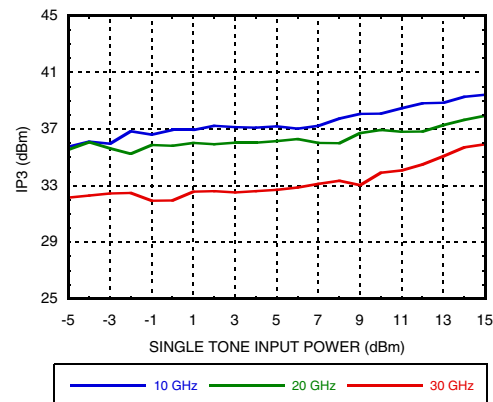

[1] Worst Case IP3



**GaAs MMIC VOLTAGE - VARIABLE
ATTENUATOR, 10 - 40 GHz**

**Input IP3 vs. Input Power Over Temperature
@ 20 GHz, Vctl1 = -2V, Vctl2 = -3V [1]**

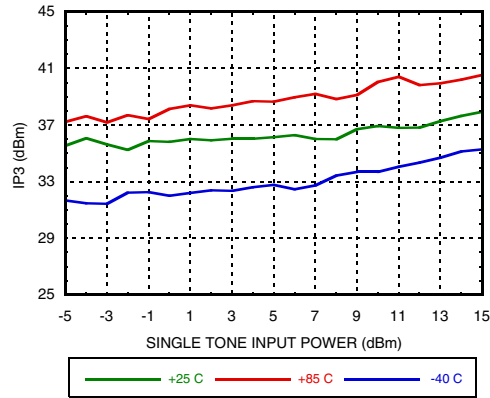

**Input IP3 vs. Input Power @ 20 GHz
Vctl2 = Variable, Vctl1 = 0V**

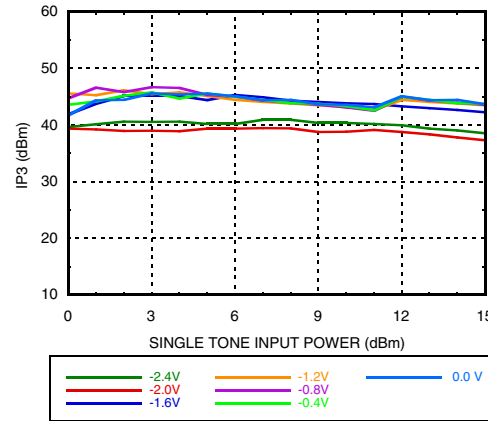

**Input IP3 vs. Input Power Over Frequency
Vctl2 = -2V, Vctl1 = 0V [1]**

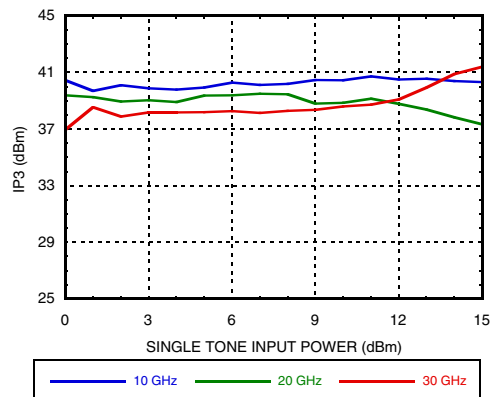

**Input IP3 vs Input Power over Tempera-
ture @ 20 GHz, Vctl2 = -2V, Vctl1 = 0V [1]**

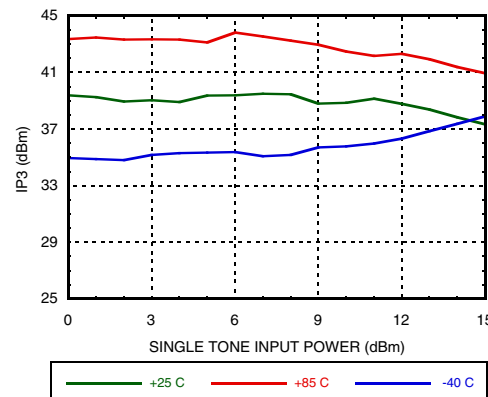

[1] Worst Case IP3



Attenuation vs Frequency Over Vctrl
Vctrl1 = Vctrl2

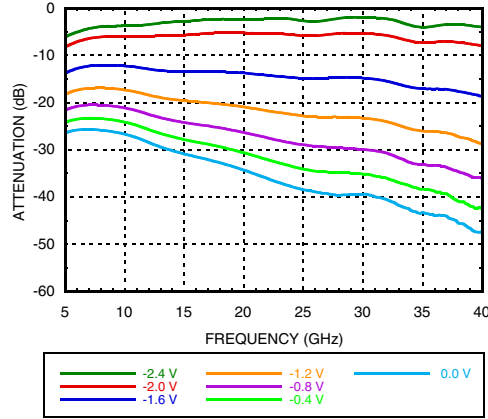

GaAs MMIC VOLTAGE - VARIABLE ATTENUATOR, 10 - 40 GHz

Attenuation vs. Vctrl Over Temperature
@ 20 GHz, Vctrl1 = Vctrl2

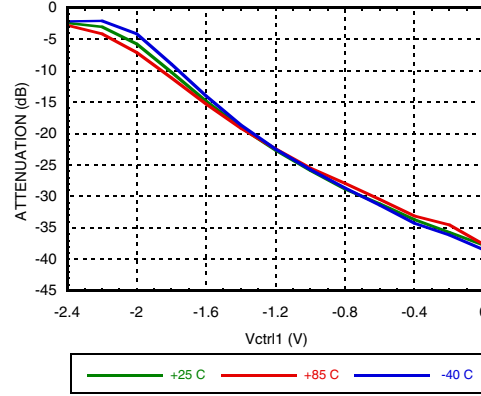

Attenuation vs. Pin @ 20 GHz Over Vctrl
Vctrl1 = Vctrl2

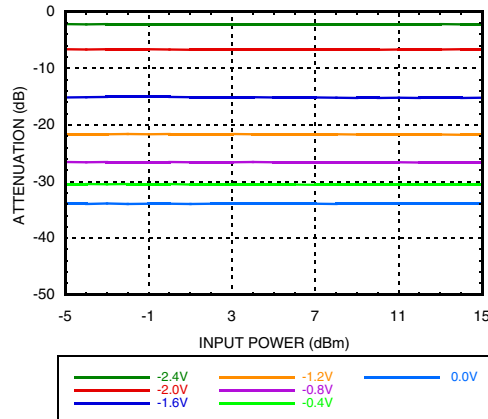

Input Return Loss, Vctrl1 = Vctrl2

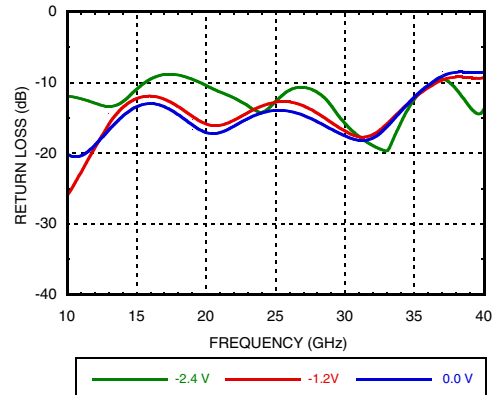

Output Return Loss, Vctrl1 = Vctrl2

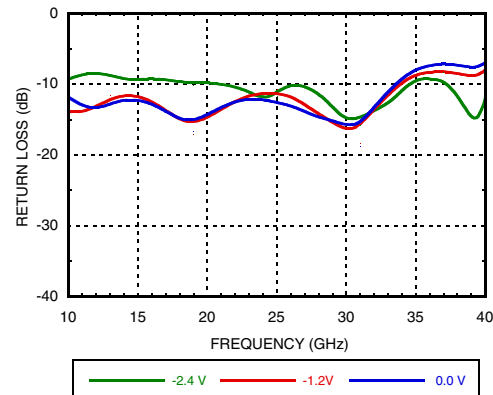

Input IP3 vs. Input Power Over Vctrl @ 20 GHz, Vctrl1 = Vctrl2

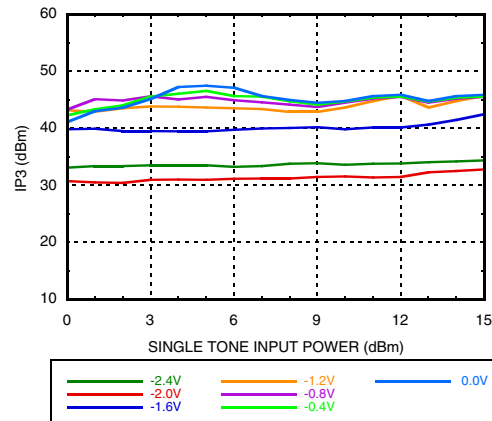

Information furnished by Analog Devices is believed to be accurate and reliable. However, no responsibility is assumed by Analog Devices for its use, nor for any infringements of patents or other rights of third parties that may result from its use. Specifications subject to change without notice. No license is granted by implication or otherwise under any patent or patent rights of Analog Devices. Trademarks and registered trademarks are the property of their respective owners.

For price, delivery, and to place orders: Analog Devices, Inc., One Technology Way, P.O. Box 9106, Norwood, MA 02062-9106 Phone: 781-329-4700 • Order online at www.analog.com Application Support: Phone: 1-800-ANALOG-D



**GaAs MMIC VOLTAGE - VARIABLE
ATTENUATOR, 10 - 40 GHz**

Input IP3 vs. Input Power Over Frequency
Vctl1 = Vctl2

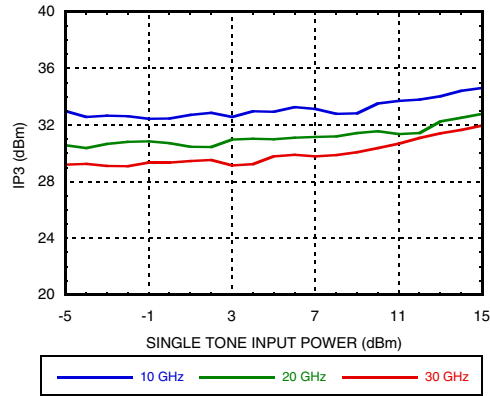

**Input IP3 vs. Input Power Over
Temperature @ 20 GHz Vctl1 = Vctl2**

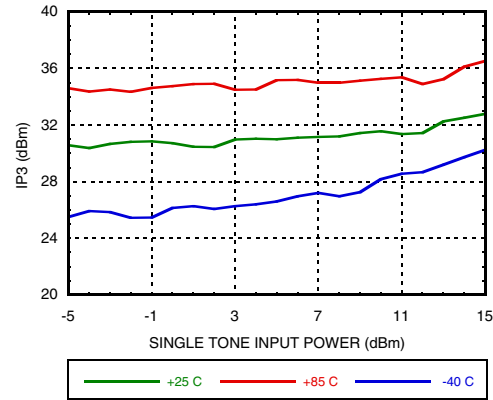



GaAs MMIC VOLTAGE - VARIABLE ATTENUATOR, 10 - 40 GHz

Absolute Maximum Ratings

Control Voltage	+1 to -5V
Input RF Power	30 dBm
Maximum Junction Temperature	165 °C
Thermal Resistance (R _{TH}) (junction to ground paddle)	62 °C/W
Operating Temperature	-40°C to +85°C
Storage Temperature	-65°C to 125°C
ESD Sensitivity (HBM)	Class1A, passed 250V



ELECTROSTATIC SENSITIVE DEVICE
OBSERVE HANDLING PRECAUTIONS

Outline Drawing

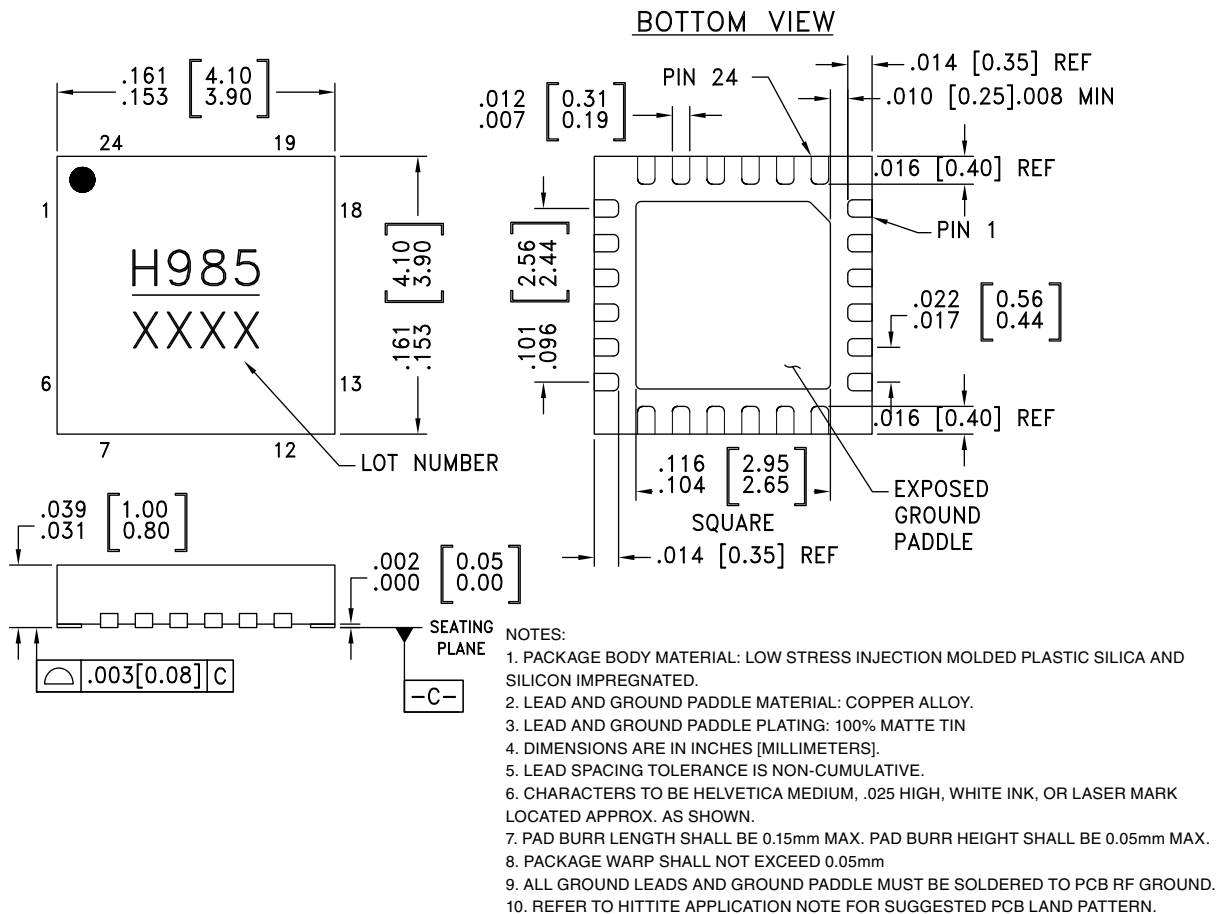

Package Information

Part Number	Package Body Material	Lead Finish	MSL Rating	Package Marking
HMC985LP4KE	RoHS-compliant Low Stress Injection Molded Plastic	100% matte Sn	MSL1 [1]	H985 XXX

[1] Max peak reflow temperature of 260 °C

[2] 4-Digit lot number XXXX



GaAs MMIC VOLTAGE - VARIABLE ATTENUATOR, 10 - 40 GHz

Pin Descriptions

Pin Number	Function	Description	Pin Schematic
1, 2, 4-7, 12-15, 17-19, 24	GND	These pins and package bottom must be connected to RF/DC ground externally.	
3	RFIN	This pad is DC coupled and matched to 50 Ohms.	
8	Vctl1	Control Voltage 1.	
9, 11, 20-23	NC	These pins are not connected internally, however all data shown herein was measured with these pins connected to RF/DC ground externally.	
10	Vctl2	Control Voltage 2.	
16	RFOUT	This pad is DC coupled and matched to 50 Ohms.	

Application Circuit

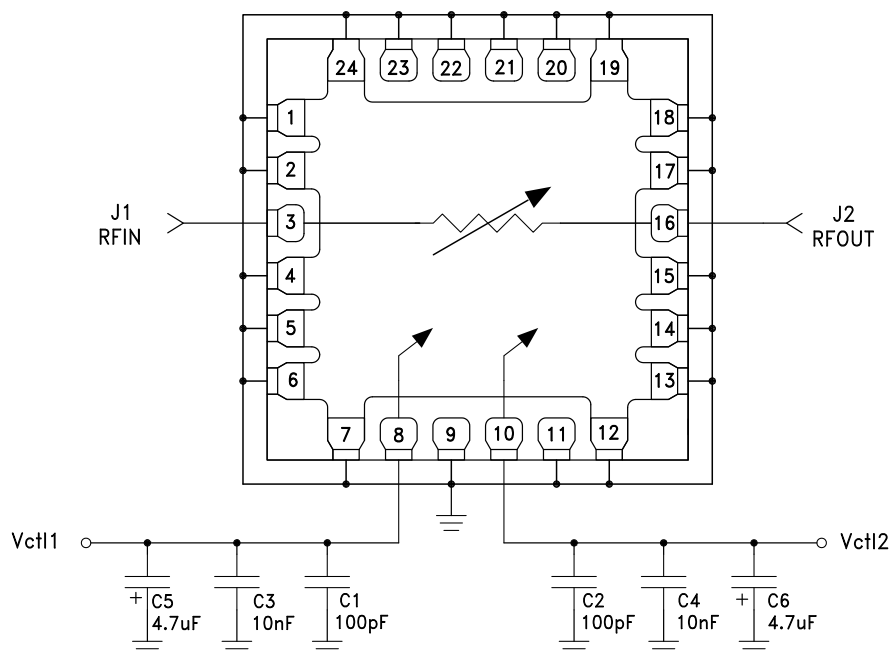

Information furnished by Analog Devices is believed to be accurate and reliable. However, no responsibility is assumed by Analog Devices for its use, nor for any infringements of patents or other rights of third parties that may result from its use. Specifications subject to change without notice. No license is granted by implication or otherwise under any patent or patent rights of Analog Devices. Trademarks and registered trademarks are the property of their respective owners.

For price, delivery, and to place orders: Analog Devices, Inc., One Technology Way, P.O. Box 9106, Norwood, MA 02062-9106 Phone: 781-329-4700 • Order online at www.analog.com Application Support: Phone: 1-800-ANALOG-D



**GaAs MMIC VOLTAGE - VARIABLE
ATTENUATOR, 10 - 40 GHz**

Evaluation PCB

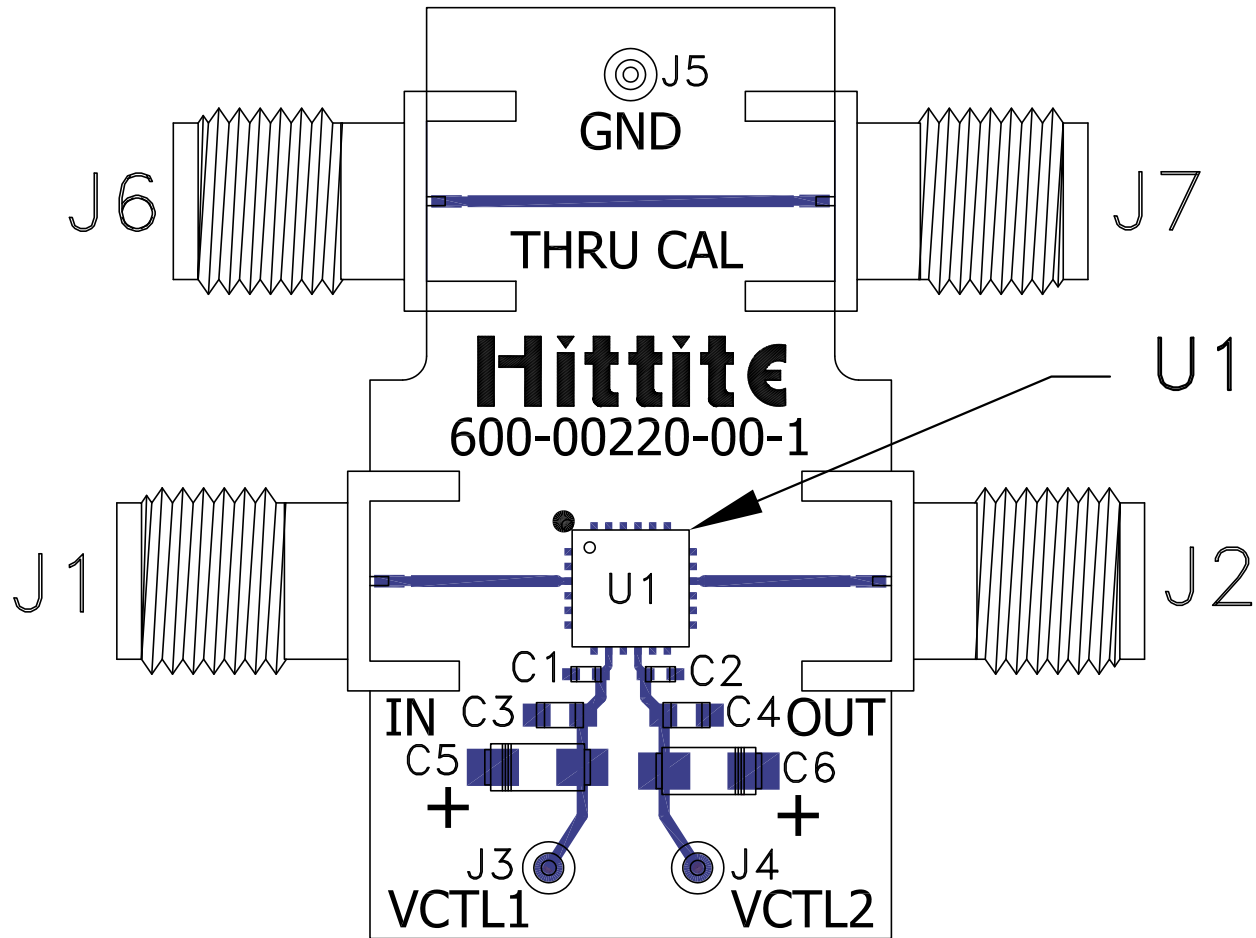

List of Materials for Evaluation PCB EVAL01-HMC985LP4KE [1]

Item	Description
J1-J2, J6-J7	K Connectors.
J3-J5	DC Pins.
C1-C2	100pF Capacitors, 0402 Pkg.
C3-C4	0.01 μ F Capacitor, 0603 Pkg.
C5-C6	4.7 μ F Case A, Tantalum.
U1	HMC985LP4KE VVA.
PCB	600-00220-00 Evaluation PCB.

[1] Reference this number when ordering complete evaluation PCB

The circuit board used in the final application should use RF circuit design techniques. Signal lines should have 50 Ohm impedance while the package ground leads and exposed paddle should be connected directly to the ground plane similar to that shown. A sufficient number of via holes should be used to connect the top and bottom ground planes. The evaluation circuit board shown is available from Hittite upon request.

**GaAs MMIC VOLTAGE - VARIABLE
ATTENUATOR, 10 - 40 GHz****Notes:**

Компания «Life Electronics» занимается поставками электронных компонентов импортного и отечественного производства от производителей и со складов крупных дистрибьюторов Европы, Америки и Азии.

С конца 2013 года компания активно расширяет линейку поставок компонентов по направлению коаксиальный кабель, кварцевые генераторы и конденсаторы (керамические, пленочные, электролитические), за счёт заключения дистрибьюторских договоров

Мы предлагаем:

- Конкурентоспособные цены и скидки постоянным клиентам.
- Специальные условия для постоянных клиентов.
- Подбор аналогов.
- Поставку компонентов в любых объемах, удовлетворяющих вашим потребностям.
- Приемлемые сроки поставки, возможна ускоренная поставка.
- Доставку товара в любую точку России и стран СНГ.
- Комплексную поставку.
- Работу по проектам и поставку образцов.
- Формирование склада под заказчика.
- Сертификаты соответствия на поставляемую продукцию (по желанию клиента).
- Тестирование поставляемой продукции.
- Поставку компонентов, требующих военную и космическую приемку.
- Входной контроль качества.
- Наличие сертификата ISO.

В составе нашей компании организован Конструкторский отдел, призванный помогать разработчикам, и инженерам.

Конструкторский отдел помогает осуществить:

- Регистрацию проекта у производителя компонентов.
- Техническую поддержку проекта.
- Защиту от снятия компонента с производства.
- Оценку стоимости проекта по компонентам.
- Изготовление тестовой платы монтаж и пусконаладочные работы.



Тел: +7 (812) 336 43 04 (многоканальный)

Email: org@lifeelectronics.ru