

# DOGM GRAPHIC SERIES

10.2009

## 128x64 DOTS

available in low quantities !  
flat: 5.6mm with LED b./l. mounted



EA DOGM128W-6 +  
EA LED55x46-A



EA DOGM128B-6 +  
EA LED55x46-W



EA DOGM128W-6 +  
EA LED55x46-W

### TECHNICAL DATA

- \* HIGH-CONTRAST LCD SUPERTWIST DISPLAY (STN AND FSTN) WITH 15µm DOT GAP
- \* OPTIONAL LED BACKLIGHTS IN VARIOUS COLORS
- \* 128x64 PIXELS (CORRESPONDS TO 8x21 CHARACTERS OR 4x10 LARGE CHARACTERS)
- \* ST 7565R CONTROLLER WITH SPI (4-WIRE) INTERFACE
- \* POWER SUPPLY: SINGLE SUPPLY 3.0V TO 3.3V (TYPICALLY 270µA)
- \* NO ADDITIONAL VOLTAGES REQUIRED
- \* OPERATING TEMPERATURE RANGE -20°C TO +70°C (STORAGE -30°C TO +80°C)
- \* LED BACKLIGHTING 5mA TO 40mA
- \* NO MOUNTING REQUIRED: SIMPLY SOLDER ONTO PCB

### ORDERING CODE

GRAPHICS DISPLAY, 128x64, 55x46mm

- x: *W* = white background (FSTN pos. transfective)  
*E* = yellow/green background (STN pos. transmissive)  
*B* = blue background (STN neg. transmissive)  
*S* = black background (FSTN neg. transmissive)  
*L* = yellow/green background (STN pos. reflective, cannot be backlit)

- LED BACKLIGHT, WHITE  
LED BACKLIGHT, YELLOW/GREEN  
LED BACKLIGHT, BLUE  
LED BACKLIGHT, RED  
LED BACKLIGHT, AMBER  
LED BACKLIGHT, GREEN  
LED BACKLIGHT, FULL COLOR RGB

### ACCESSORIES

- USB TEST BOARD FOR PC (WINDOWS)  
TOUCH PANEL, 4-WIRE, ANALOG, STICK-ON  
ZIF CONNECTOR FOR TOUCH PANEL, BOTTOM CONTACT  
SOCKET CONNECTOR 4.8 mm HEIGHT (2 PCS. REQUIRED)

**EA DOGM128X-6**

- EA LED55X46-W**  
**EA LED55X46-G**  
**EA LED55X46-B**  
**EA LED55X46-R**  
**EA LED55X46-A**  
**EA LED55X46-E**  
**EA LED55X46-RGB**

- EA 9780-1USB**  
**EA TOUCH128-1**  
**EA WF100-04S**  
**EA FL-20P**

**ELECTRONIC  
ASSEMBLY**

making things easy

## EA DOGM128

The EA DOGM128, a 128x64-pixel graphics display, is a new addition to ELECTRONIC ASSEMBLY's EA DOGM series. It, too, has pins that allow it to be mounted quickly and easily. 7 different optional LED backlights are available. These can be combined with 5 different display technologies, making it possible to have up to around 20 different designs. Designed for compact, handheld devices, this modern LCD series offers a number of benefits with and without backlighting:

- \* Extremely compact (55x46 mm) with a large viewing area of 51x31 mm
- \* Super-flat: 2.0 mm without backlight module, and only 5.8 mm with a b./l. module mounted
- \* Serial SPI interface (4-wire)
- \* Single supply +3.0 V or +3.3 V
- \* Typical power consumption of only 150µA in full operation (white LED backlight from 5mA)
- \* Easily mounted by soldering
- \* Wide range of design variants orderable as single units
- \* Backlighting color changes possible

## CONTRAST ADJUSTMENT

The contrast can be set by means of a command for all the displays in the EA DOGM series. The contrast setting of the display must be set once by the software, and is then kept constant throughout the entire operating temperature range (-20..+70°C), thanks to the integrated temperature compensation.

## LED BACKLIGHT

7 different variants are available for individual backlighting: white, yellow/green, green, blue, red, amber and a full-color version.

There are 3 separate LED paths available for each monochrome backlight that can be switched in parallel or in series to suit the system voltage. This means that most backlights can be run at either 3.3 V or 5 V.

To operate the backlight, we recommend a current source (e.g. CAT4238TD) or an external series resistor to limit the current. This can be calculated from  $R=U/I$ ; you can find the values in the table on the right. To prolong the life of the backlights, we recommend that you use a current source.

The operating life of the yellow/green, red and amber backlights is 100,000 hours. The life of the white and blue backlights is considerably shorter. We recommend that you dim these or switch them off whenever possible.

**Important:** Never connect the backlight LEDs directly to a 5 V/3.3 V supply as this will immediately destroy the LEDs. Always use a current source. Please note that derating applies at temperatures exceeding +25°C.

LED backlight	Forward voltage (V)			Current max. (mA)	Limiting resistor (ohm, each path)	
	min	typ	max		@3,3 V	@5 V
yellow/green EA LED55x46-G		2,1		40	40	97
white EA LED55x46-W		3,3		25	CAT4238	82
amber EA LED55x46-A		1,9		40	47	103
green EA LED55x46-E		3		40	8,5	57
blue EA LED55x46-B		3,3		30	CAT4238	68
red EA LED55x46-R		1,9		40	47	103
full color EA LED55x46-RGB	red typ. 4V	green typ. 4V	blue typ. 4V	40 each colour	CAT4238	25

## ASSEMBLING





First, clip the display and backlight modules together by gently pushing the display pins through the corresponding holes on the backlight module. Then insert the entire module into the socket, or into the soldering holes on the pcb. The backlight pins (the 2 rows with 3 pins at the bottom) must be soldered on the top side as well to ensure good contact between the modules.

**Important:** The display has a protective film on the top and/or the bottom, and there is also one on the backlight. These must be removed.

Make sure that neither display nor backlight will never come into contact with any kind of liquid like Fluxer, Cleaner, Water.

**5 DIFFERENT TECHNOLOGIES**

See below for an overview of available technologies, combinations with available backlights and their usability:

display type	technology	optional backlight	readability	display color non backlighted	display color with backlighted	recommended backlight color
	FSTN pos. transfective	it's fine with and without backlight	readable even without backlight	black on white	black on backlight color	white, blue, green, RGB
	STN pos. yellow/green transmissive	backlight unit required	readable even without backlight	dark green on yellow/green	black on yellow/green or amber	yellow/green, amber
	STN neg. blue transmissive	usage only with backlight	---	---	backlight color on blue background	white, yellow/green
	FSTN neg. transmissive	usage only with backlight	---	---	backlight color on black background	white, green, RGB
	STN pos. yellow/green reflective	no backlight possible	finest readable without backlight	dark green on yellow/green	---	---

**6 AND MORE DIFFERENT BACKLIGHTS**

6 and more different backlight colors are available to match equipments design as much as possible. The most effective and brightest one is the white one EA LED55x31-W.

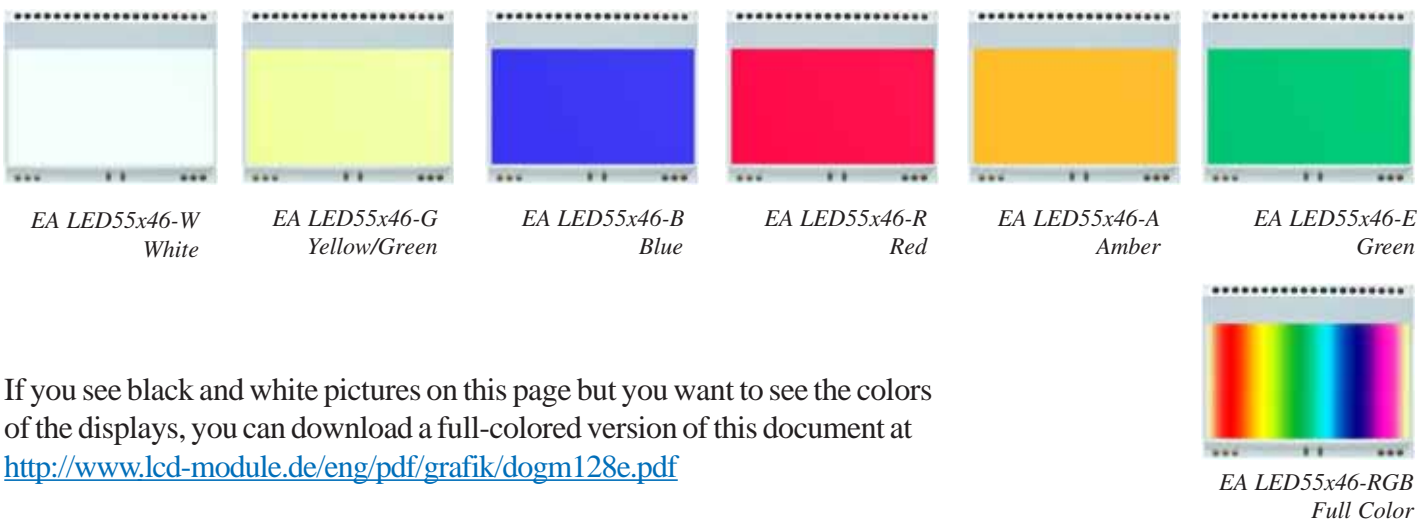

If you see black and white pictures on this page but you want to see the colors of the displays, you can download a full-colored version of this document at <http://www.lcd-module.de/eng/pdf/grafik/dogm128e.pdf>

## APPLICATION EXAMPLES

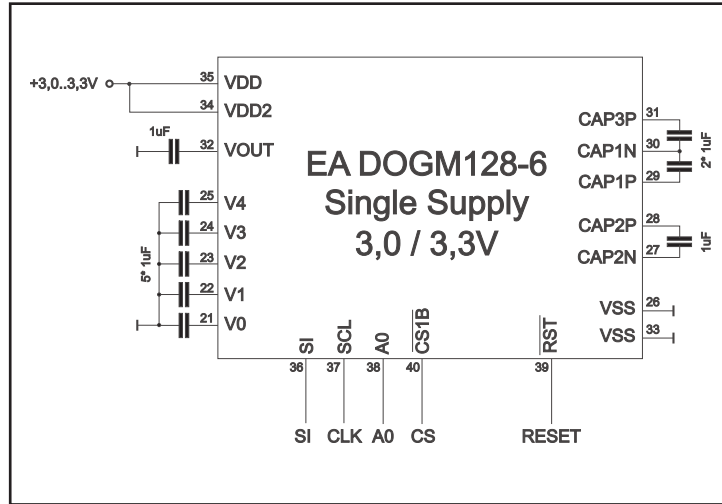

+3.0V or +3.3V (single supply) operation requires 9 external capacitors



If an external source of +10.5 ~ +13.5V (does not have to be stabilized) is available, the charge pump is not needed and less external components are required.

## USB-TEST BOARD EA 9780-1USB

For easy startup, a USB test board is available that can be connected to a PC. A USB cable and Windows software is supplied with the product. This allows text and images (BMP) to be displayed directly on the connected display. You will find more information on the test board in the EA 9780-1USB data sheet.

## SIMULATION WITH WINDOWS

A simulator window also displays the contents of the display. The software can simulate all the displays and colors even without the hardware. You can download the software free from our website:

<http://www.lcd-module.de/deu/disk/startdog.zip>





**TABLE OF PROGRAMMING COMMANDS**

Command	Command Code									Function	
	A0	D7	D6	D5	D4	D3	D2	D1	D0		
(1) Display ON/OFF	0	1	0	1	0	1	1	1	0	1	LCD display ON/OFF 0: OFF, 1: ON
(2) Display start line set	0	0	1	Display start address							Sets the display RAM display start line address
(3) Page address set	0	1	0	1	1	Page address				Sets the display RAM page address	
(4) Column address set upper bit	0	0	0	0	1	Most significant column address				Sets the most significant 4 bits of the display RAM column address.	
Column address set lower bit		0	0	0	0	Least significant column address				Sets the least significant 4 bits of the display RAM column address.	
(6) Display data write	1	Write data								Writes to the display RAM	
(8) ADC select	0	1	0	1	0	0	0	0	0	1	Sets the display RAM address SEG output correspondence 0: normal, 1: reverse
(9) Display normal/reverse	0	1	0	1	0	0	1	1	0	1	Sets the LCD display normal/ reverse 0: normal, 1: reverse
(10) Display all points ON/OFF	0	1	0	1	0	0	1	0	0	1	Display all points 0: normal display 1: all points ON
(11) LCD bias set	0	1	0	1	0	0	0	1	0	1	Sets the LCD drive voltage bias ratio 0: 1/9 bias, 1: 1/7 bias (ST7565R)
(14) Reset	0	1	1	1	0	0	0	1	0		Internal reset
(15) Common output mode select	0	1	1	0	0	0	*	*	*	1	Select COM output scan direction 0: normal direction 1: reverse direction
(16) Power control set	0	0	0	1	0	1	Operating mode				Select internal power supply operating mode
(17) V <sub>0</sub> voltage regulator internal resistor ratio set	0	0	0	1	0	0	Resistor ratio				Select internal resistor ratio(Rb/Ra) mode
(18) Electronic volume mode set	0	1	0	0	0	0	0	0	0	1	Set the V <sub>0</sub> output voltage electronic volume register
Electronic volume register set		0	0	Electronic volume value							
(19) Static indicator ON/OFF	0	1	0	1	0	1	1	0	0	1	0: OFF, 1: ON
Static indicator register set		0	0	0	0	0	0	0	0	0	Mode
(20) Booster ratio set	0	1	1	1	1	1	0	0	0	0	select booster ratio 00: 2x,3x,4x 01: 5x 11: 6x
(21) Power save	0										Display OFF and display all points ON compound command
(22) NOP	0	1	1	1	0	0	0	1	1		Command for non-operation

0 ----- Column address ----- 127

D0   D7	Page 0
D0   D7	Page 1
D0   D7	Page 2
D0   D7	Page 3
D0   D7	Page 4
D0   D7	Page 5
D0   D7	Page 6
D0   D7	Page 7

**DATA TRANSFER**

Data transfer is unidirectional. That means that data can only be written; it cannot be read again. In contrast to other displays, a busy query is not necessary with this display. The clock-pulse rate of the SCL line can be up to 20 MHz, depending on the supply voltage. You will find more detailed information on timing on pages 64 and 65 of the data sheet of the ST7565R controller, which you will find on our website at

<http://www.lcd-module.de/eng/pdf/zubehoer/st7565r.pdf>

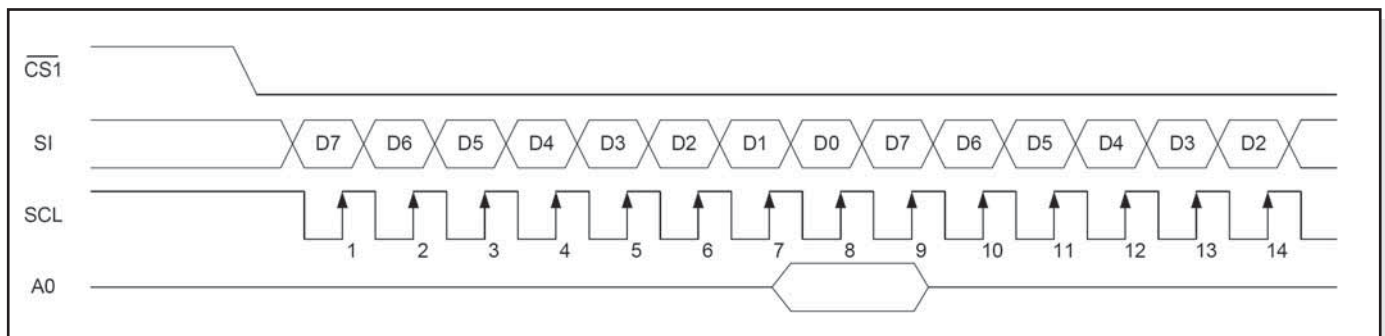

## INITIALISATION EXAMPLE

Internal contrast voltage generator (single supply +3.0V / +3.3V)

Initialisation example for single supply +3.3V (bottom view)												
Command	A0	D7	D6	D5	D4	D3	D2	D1	D0	Hex	Remark	
(2) Display start line set	0	0	1	0	0	0	0	0	0	\$40	Display start line 0	
(8) ADC set	0	1	0	1	0	0	0	0	1	\$A1	ADC reverse *)	
(15) Common output mode select	0	1	1	0	0	0	0	0	0	\$C0	Normal COM0~COM63	
(9) Display normal/reverse	0	1	0	1	0	0	1	1	0	\$A6	Display normal	
(11) LCD bias set	0	1	0	1	0	0	0	1	0	\$A2	Set bias 1/9 (Duty 1/65)	
(16) Power control set	0	0	0	1	0	1	1	1	1	\$2F	Booster, Regulator and Follower on	
(20) Booster ratio set	0	1	1	1	1	1	0	0	0	\$F8	Set internal Booster to 4x	
		0	0	0	0	0	0	0	0	\$00		
(17) V0 voltage regulator set	0	0	0	1	0	0	1	1	1	\$27	Contrast set	
(18) Electronic volume mode set	0	1	0	0	0	0	0	0	1	\$81		
		0	0	0	1	0	1	1	0	\$16		
(19) Static indicator set	0	1	0	1	0	1	1	0	0	\$AC	No indicator	
		0	0	0	0	0	0	0	0	\$00		
(1) Display ON/OFF	0	1	0	1	0	1	1	1	1	\$AF	Display on	

\*) Make sure that for 6:00 viewing direction ADC has to be set to „reverse“ (mirrored layout) !



Orientation for 6:00 (Bottom View)

## INITIALISATION EXAMPLE

External contrast voltage (dual power supply)

Initialisation example for dual power supply (bottom view)												
Command	A0	D7	D6	D5	D4	D3	D2	D1	D0	Hex	Remark	
(2) Display start line set	0	0	1	0	0	0	0	0	0	\$40	Display start line 0	
(8) ADC set	0	1	0	1	0	0	0	0	1	\$A1	ADC reverse *)	
(15) Common output mode select	0	1	1	0	0	0	0	0	0	\$C0	Normal COM0~COM63	
(9) Display normal/reverse	0	1	0	1	0	0	1	1	0	\$A6	Display normal	
(11) LCD bias set	0	1	0	1	0	0	0	1	0	\$A2	Set bias 1/9 (Duty 1/65)	
(16) Power control set	0	0	0	1	0	1	0	1	1	\$2B	Booster off, Regulator, Follower on	
(17) V0 voltage regulator set	0	0	0	1	0	0	1	1	1	\$27	Contrast set	
(18) Electronic volume mode set	0	1	0	0	0	0	0	0	1	\$81		
		0	0	0	1	0	1	1	0	\$16		
(19) Static indicator set	0	1	0	1	0	1	1	0	0	\$AC	No indicator	
		0	0	0	0	0	0	0	0	\$00		
(1) Display ON/OFF	0	1	0	1	0	1	1	1	1	\$AF	Display on	

\*) Make sure that for 6:00 viewing direction ADC has to be set to „reverse“ (mirrored layout) !

### 12:00 VIEWING ANGLE, TOP VIEW OPTION

If the display is read mostly from above (on the front of a laboratory power supply unit, for example), the preferred angle of viewing can be set to 12 o'clock. This rotates the display by 180°. A slightly different initialization setup is required for this. Also keep in mind that the leftmost column (normally numbered as 0) will now change to 4.



Assembling for 12:00 (Top View)

4 Column address ---131	
D0 D7	Page 0
D0 D7	Page 1
D0 D7	Page 2
D0 D7	Page 3
D0 D7	Page 4
D0 D7	Page 5
D0 D7	Page 6
D0 D7	Page 7

Initialisation example top view											
Command	A0	D7	D6	D5	D4	D3	D2	D1	D0	Hex	Remark
(8) ADC set	0	1	0	1	0	0	0	0	0	\$A0	ADC normal
(15) Common output mode select	0	1	1	0	0	1	0	0	0	\$C8	Reverse COM63-COM0

### TOUCH PANEL EA TOUCH128-1 (OPTIONAL)

An analog touch panel is available as an accessory. It has a self-adhesive material on its rear surface and is simply stuck onto the display. The connection is made by means of a 4-pin flexible cable for a ZIF connector (e.g. EA WF100-04S) with a grid of 1.0 mm. Bending radius is defined with min. 5mm. For optimum readability we recommend that you use a backlight with the display.

Interfacing to a processor can be either done by an external touch panel controller or with a controller that is featured with analogue input. The touch panel is similar to a potentiometer: connecting

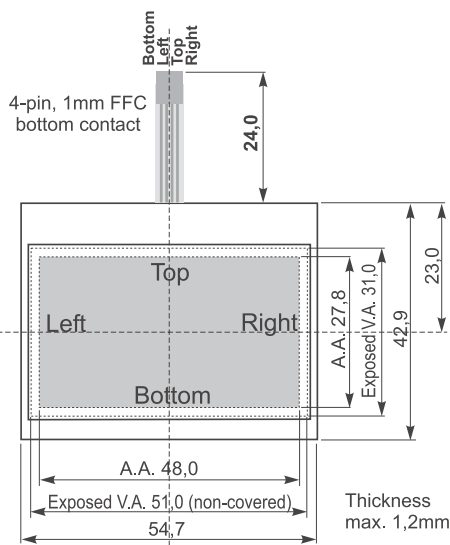

a voltage of e.g. 3.3V to the pins *Top-Bottom* makes it possible to read out a voltage on pin *Left* or *Right* which is linear to the Y-coordinate of the pressed point. The X-coordinate will result when the voltage will be supplied to *Left-Right* and measurement is done at *Top* or *Bottom*.

The pinout of the connecting cable is shown in the drawing.

Specification			
Specification	min	max	Unit
Top-Bottom	120	300	Ω
Left-Right	580	900	Ω
Voltage	3	12	V
Current	5	25	mA
Linearity		1,5	%
Force	45	65	g
Contact Bounce	5	10	ms
Op. Temperatur	-20	+60	°C
Stor. Temperatur	-20	+70	°C
Transmission	75	85	%
Life Time	10000		Cycles

### ZIF CONNECTOR EA WF100-04S

As an accessory for the touch panel we do provide a ZIF connector (4 pins) with pitch 1.0mm (SMD type). This connector „bottom side contact“ type.

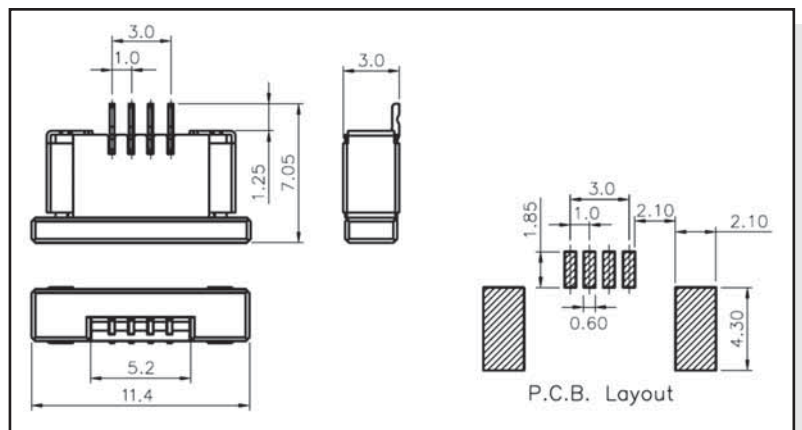

## DIMENSIONS EA DOGM128

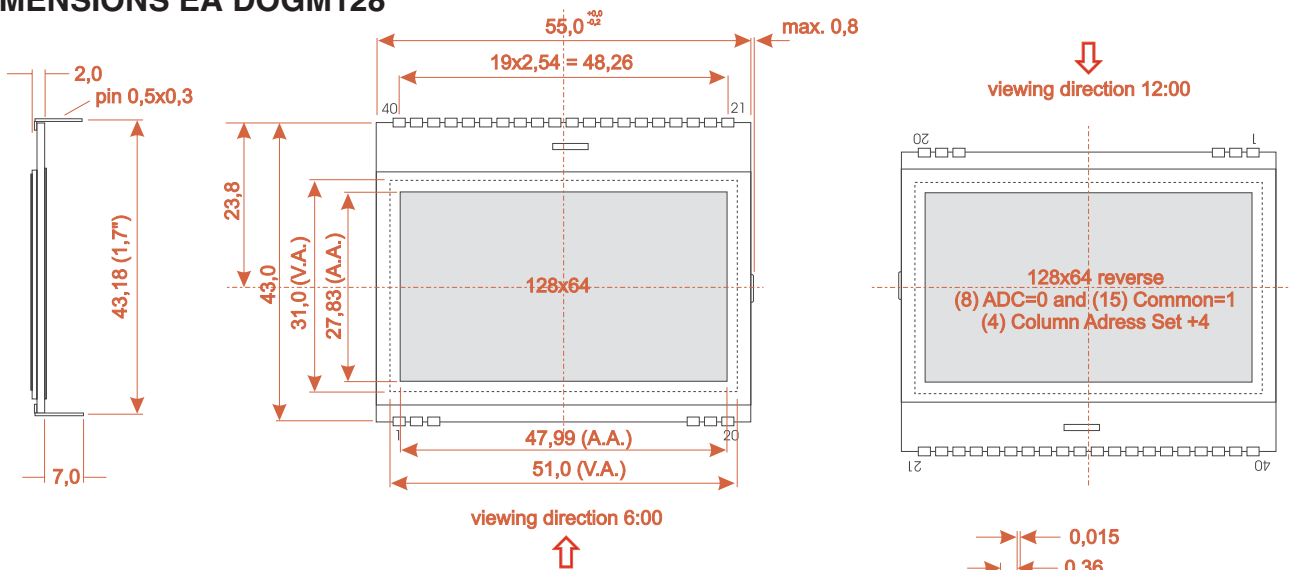

Pin	Symbol	Level	Function	Pin	Symbol	Level	Function
1	NC		(A1+: LED backlight)	21	V0	-	LC Drive
2	NC		(A2+: LED backlight)	22	V1	-	LC Drive
3	NC		(A3+: LED backlight)	23	V2	-	LC Drive
4				24	V3	-	LC Drive
5				25	V4	-	LC Drive
6				26	VSS	L	Power Supply 0V (GND)
7				27	CAP2N	-	Voltage Converter
8				28	CAP2P	-	Voltage Converter
9				29	CAP1P	-	Voltage Converter
10				30	CAP1N	-	Voltage Converter
11				31	CAP3P	-	Voltage Converter
12				32	VOUT	-	Voltage Output about +12V
13				33	VSS	L	Power Supply 0V (GND)
14				34	VDD2	H	Power Supply Booster
15				35	VDD	H	Power Supply +2.4..3.3V
16				36	SI	H/L	Serial Data In
17				37	SCL	H/L	Serial Clock
18	NC		(C1-: LED backlight)	38	A0	H/L	L= Command, H= Data
19	NC		(C2-: LED backlight)	39	RST	L	Reset (active low)
20	NC		(C3-: LED backlight)	40	CS1B	L	Chip Select (active low)

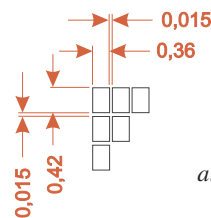

all dimensions are in mm

**Note:**

- LC displays are generally not suited for wave or reflow soldering. Temperatures of over 80°C can cause lasting damage.
- The surfaces of the displays and backlights are protected from scratching by self-adhesive protective foils. Please remove these before mounting (2 pcs. on display and 1 pc. on backlight).
- Make sure that either display nor backlight will never come into contact with any kind of liquid like Fluxer, Cleaner, Water.

## DIMENSIONS EA LED55X46

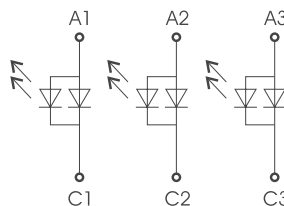
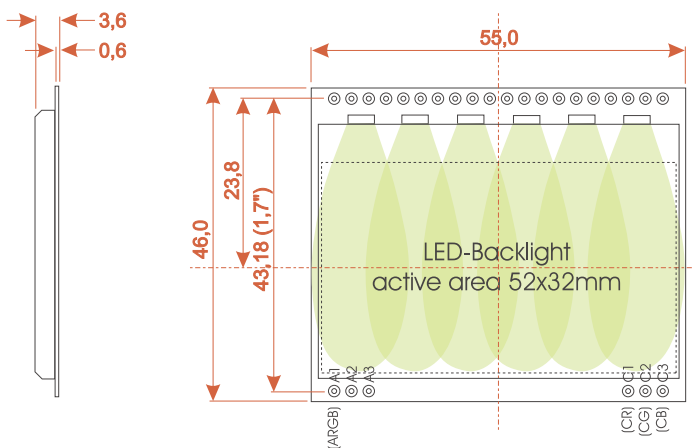

**Note:**

The 6(4) LED pins A1 to A3 and C1 to C3 also have to be soldered from above to ensure good contact.

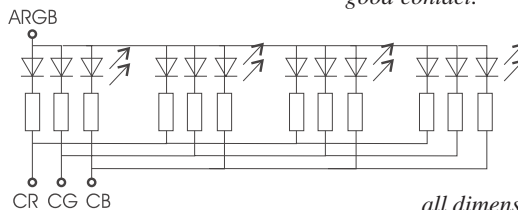

all dimensions are in mm



Компания «Life Electronics» занимается поставками электронных компонентов импортного и отечественного производства от производителей и со складов крупных дистрибьюторов Европы, Америки и Азии.

С конца 2013 года компания активно расширяет линейку поставок компонентов по направлению коаксиальный кабель, кварцевые генераторы и конденсаторы (керамические, пленочные, электролитические), за счёт заключения дистрибьюторских договоров

Мы предлагаем:

- Конкурентоспособные цены и скидки постоянным клиентам.
- Специальные условия для постоянных клиентов.
- Подбор аналогов.
- Поставку компонентов в любых объемах, удовлетворяющих вашим потребностям.
- Приемлемые сроки поставки, возможна ускоренная поставка.
- Доставку товара в любую точку России и стран СНГ.
- Комплексную поставку.
- Работу по проектам и поставку образцов.
- Формирование склада под заказчика.
- Сертификаты соответствия на поставляемую продукцию (по желанию клиента).
- Тестирование поставляемой продукции.
- Поставку компонентов, требующих военную и космическую приемку.
- Входной контроль качества.
- Наличие сертификата ISO.

В составе нашей компании организован Конструкторский отдел, призванный помогать разработчикам, и инженерам.

Конструкторский отдел помогает осуществить:

- Регистрацию проекта у производителя компонентов.
- Техническую поддержку проекта.
- Защиту от снятия компонента с производства.
- Оценку стоимости проекта по компонентам.
- Изготовление тестовой платы монтаж и пусконаладочные работы.



Тел: +7 (812) 336 43 04 (многоканальный)  
Email: [org@lifeelectronics.ru](mailto:org@lifeelectronics.ru)