

Features

- Compact Size (14x24 mm²)
- GaN on SiC D-Mode Transistor Technology
- Fully Matched, de-coupled DC and RF
- Typical Bias: 50 V, Class AB
- Intended for Pulsed RADAR Applications
- Output Power > 90 W, with 30 dB Gain and 60% Power Added Efficiency
- Pulse width up to 600 μ s.
- MTTF = 600 years ($T_J < 200^\circ\text{C}$)
- Thermally Enhanced Laminate LGA Package
- RoHS* Compliant. Lead Free Reflow Compatible
- MSL-3



Description

The MAMG-000912-090PSM is a 2-stage GaN power module in a “True SMT” laminate package. The module is fully matched. Under pulsed conditions, it can deliver output power greater than 90 W, with 30 dB typical associated gain and 60% typical power added efficiency.

Flexible design allows for gate and/or drain pulsing. Additional features include a gate voltage sense port for use in temperature compensation or pulse droop compensation. The overall package size is very small, only 14x24 mm². The module’s compact size, combined with excellent RF performance makes this product an ideal solution for pulsed RADAR applications where small size, light weight and performance (SWaP) are the key.

Functional Schematic

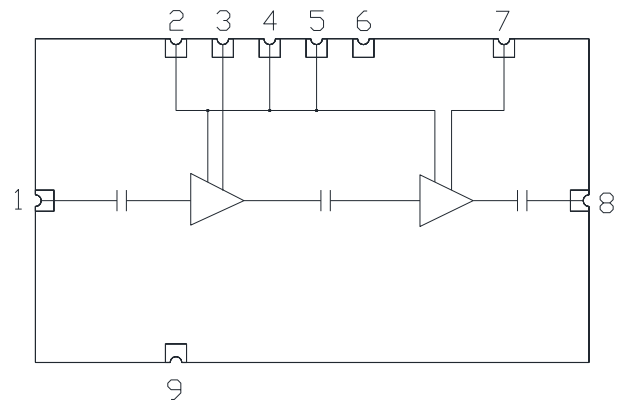

Pin Configuration

Pin No.	Function
1	RF IN
2	VG ³
3	VD1
4	NC ⁴
5	VG sense ⁵
6	Ground
7	VD2
8	RF OUT
9	NC ⁴

3. One common gate voltage for both stages in the module.
4. Do not connect.
5. Do not connect to ground if not used.

Ordering Information¹

Part Number	Package
MAMG-000912-090PSM	Bulk Packaging
MAMG-0T0912-090PSM	100 Piece Reel
MAMG-A00912-090PSM	Evaluation Board ²

1. Reference Application Note M513 for reel size information.
2. Includes one module surface mounted onto board.

* Restrictions on Hazardous Substances, European Union Directive 2002/95/EC.

960-1215 MHz 90 W 2-Stage GaN Module Surface Mount Laminate Package

Rev. V2

Electrical Specifications ⁶

Parameter	Symbol	Min.	Typ.	Max.	Typ.	Typ.	Units
RF FUNCTIONAL TESTS: Freq. = 960-1215 MHz, V_{DD} = 50 V, I_{DQ} = 300 mA, T_A = 25°C, Z_L = 50 Ω, Pulse Width = 300 us, Duty Cycle = 10%, P_{IN} = 19 dBm							
Frequency	f	960			1090	1215	MHz
Peak Output Power ⁷	P _{OUT}	90	95	-	105	105	W
Power Gain	G _P	-	30	-	31	31	dB
Power Added Efficiency	PAE	55	58	-	63	63	%
Pulse Droop ⁸	Droop	-	0.2	0.3	0.2	0.2	dB
2 nd Harmonic	2F ₀	-	-30	-	-30	-30	dBc
3 rd Harmonic	3F ₀	-	-40	-	-40	-40	dBc
Load Mismatch Stability	VSWR-S	-	5:1	-	5:1	5:1	-
Load Mismatch Tolerance	VSWR-T	-	6:1	-	6:1	6:1	-

6. Typical RF performance measured in RF evaluation board (see layout on page 3).

7. Peak output power measured at center of pulse.

8. Pulse droop measured between 10% and 90% of pulse.

Absolute Maximum Ratings ^{9,10,11,12,13}

Parameter	Absolute Maximum
Input Power	24 dBm
Drain Supply Voltage (pulsed), V _{DD}	+55 V
Gate Supply Voltage Range, V _{GG}	-9 V to -2.5 V
Supply Current, I _{DD}	4.0 A
Power Dissipation, Pulsed Mode @ 85°C	80 W
Junction Temperature ¹⁴	200 °C
Operating Temperature	-40°C to +85°C
Storage Temperature	-65°C to +150°C
ESD Maximum - Human Body Model (HBM)	600 V
ESD Maximum - Charged Device Model (CDM)	300 V

9. Exceeding any one or combination of these limits may cause permanent damage to this device.

10. MACOM does not recommend sustained operation near these survivability limits.

11. For saturated performance it is recommended that the sum of $(3 * V_{DD} + \text{abs}(V_{GG})) \leq 175 \text{ V}$.

12. CW operation is not recommended.

13. Operating at nominal conditions with T_J ≤ 200°C will ensure MTTF > 1 x 10⁶ hours. Junction temperature directly affects device MTTF and should be kept as low as possible to maximize lifetime.

14. Junction Temperature (T_J) = T_C + Θ_{JC} * ((V * I) - (P_{OUT} - P_{IN})).

Typical Transient Thermal Resistance Θ_{JC} = 1.6 °C/W (50V, 600 μs pulses, 10% duty cycle)

Evaluation Board Outline

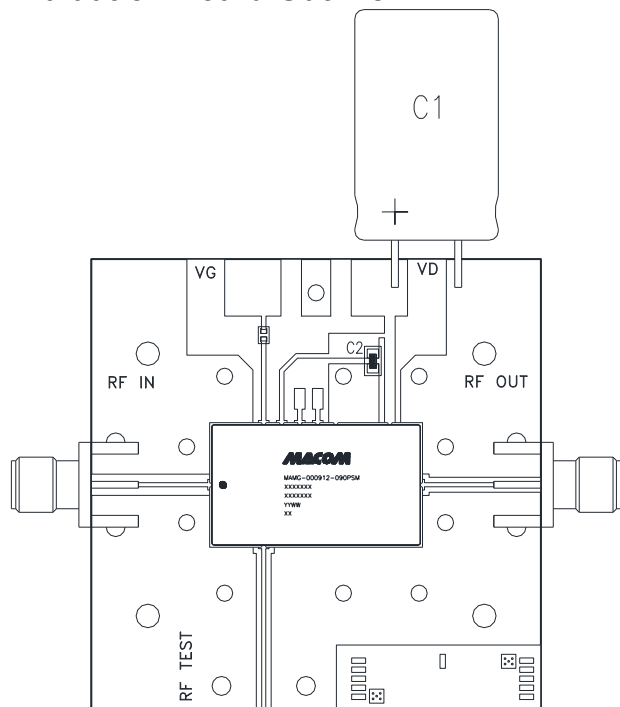

Parts List

Part	Value	Case Style
C1	100 μ F	Radial
C2	10 nF	0603

Parts are measured and sampled in the evaluation board shown on the left. The board is made of 8-mil thick RO4003C and is bolted onto a Ni-plated Aluminum plate. Electrical and thermal ground is provided using a Cu-filled via-hole array (pictured below). Very few external components are used, as DC blocks are not required.

Bias Sequencing

Turning the device ON

1. Set V_G to the pinch-off value (V_P), typically -6 V.
2. Turn on V_D to nominal voltage (50 V).
3. Increase V_G to desired quiescent current.
4. Apply RF power to desired level.

Turning the device OFF

1. Turn off RF power.
2. Decrease V_G down to V_P .
3. Turn off V_D .
4. Turn off V_G .

Applications Section

Typical Large-Signal Performance Curves Over Temperature:
Pulsed RF, 300 μ s Pulses, 10% Duty Cycle, $V_{DD} = 45$ V, $I_{DQ} = 300$ mA, $P_{IN} = 19$ dBm

Output Power vs. Frequency

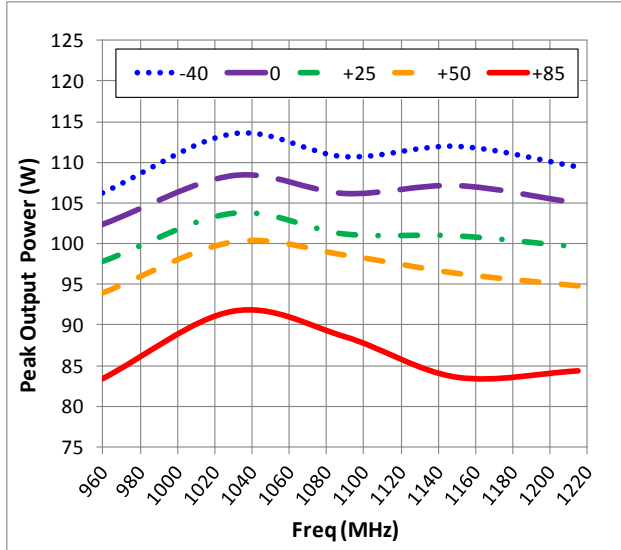

Power Added Efficiency vs. Frequency

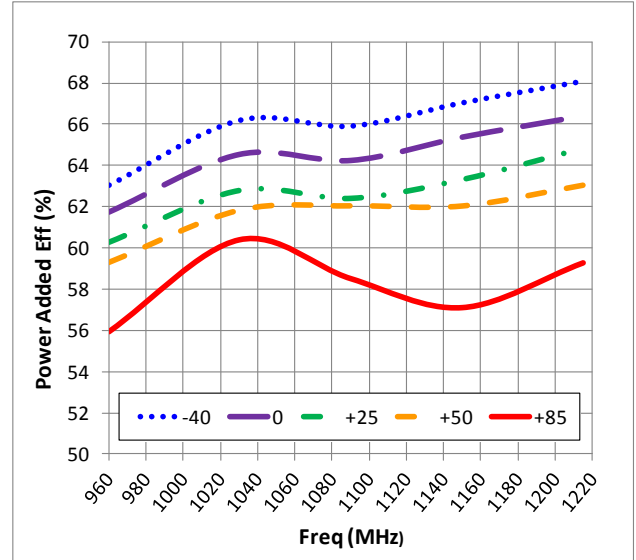

Pulse Droop vs. Frequency

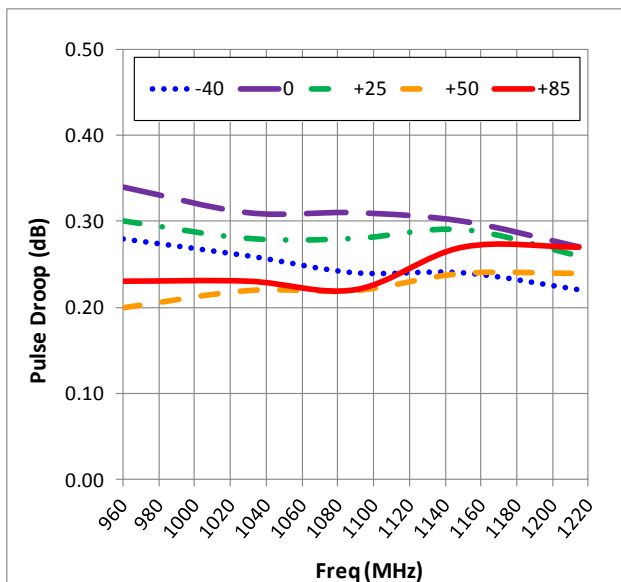

Applications Section

Maximum Transient Channel Temperature (Based on IR-Scan Measurements)
Pulsed RF, $I_{DQ} = 300\text{ mA}$, $P_{IN} = 19\text{ dBm}$, $T_C = 80^\circ\text{C}$

Max. Transient Channel Temp. vs. Pulse Width
($V_{DD} = 35\text{ V}$)

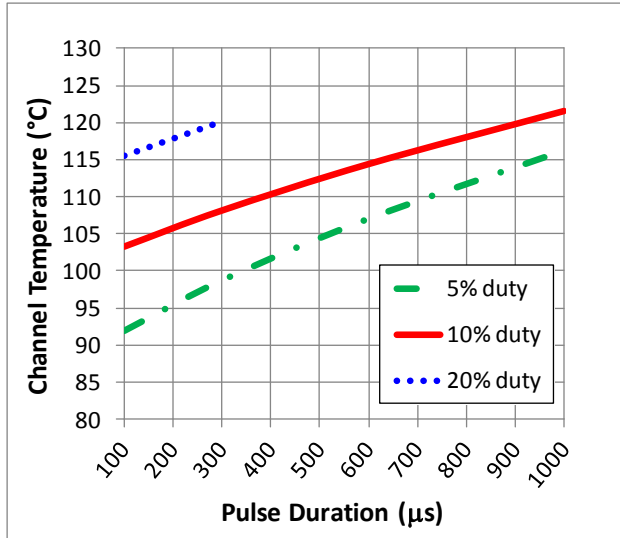

Max. Transient Channel Temp. vs. Pulse Width
($V_{DD} = 45\text{ V}$)

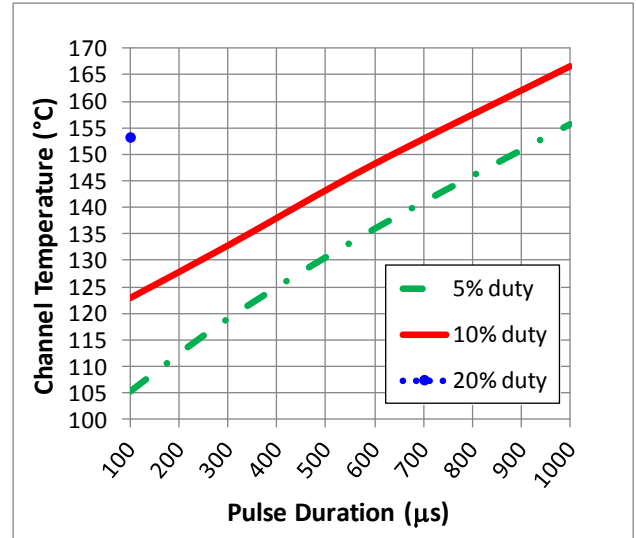

Max. Transient Channel Temp. vs. Pulse Width
($V_{DD} = 50\text{ V}$)

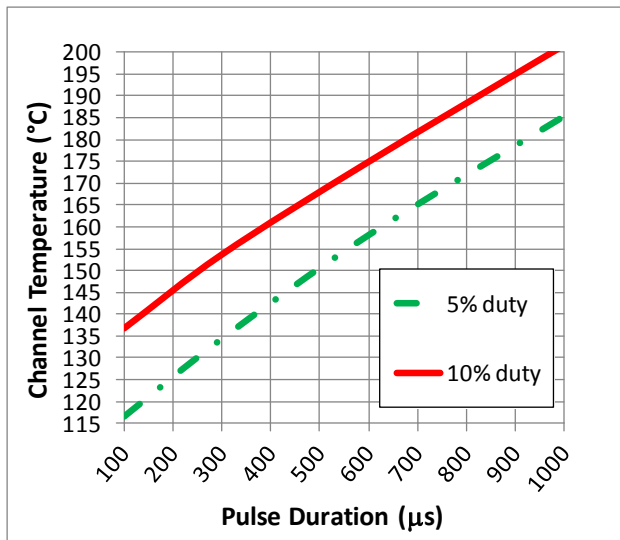

960-1215 MHz 90 W 2-Stage GaN Module Surface Mount Laminate Package

Rev. V2

Package Outline ^{15,16,18}

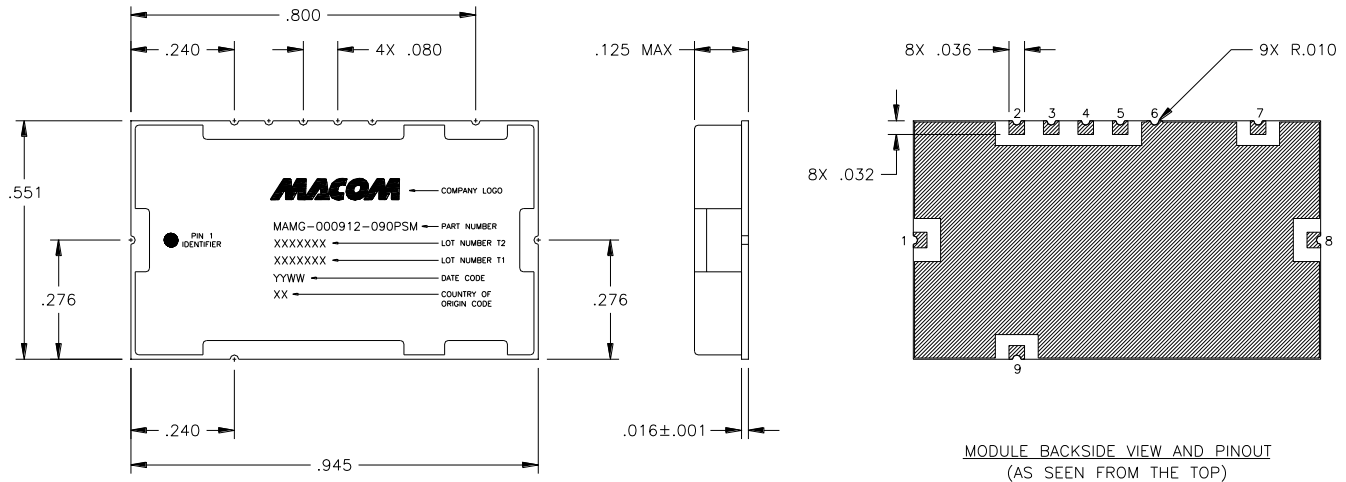

Recommended Landing Pattern ^{15,16,17,18}

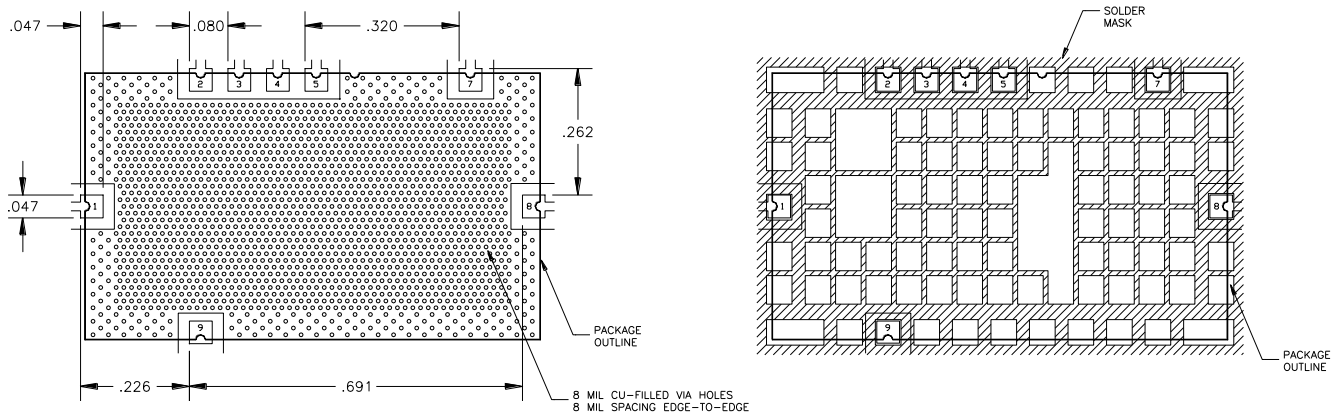

15. All dimensions are in inches.
16. Reference Application Note S2083 for lead-free solder reflow recommendations. Plating is Ni/Pd/Au.
17. Landing pattern indicates solder mask opening. Cu-filled via-holes under the ground are used for optimal thermal performance. Recommended pattern: 8-mil diameter, 8-mil spacing.
18. Layout drawing available upon request.

Handling Procedures

Please observe the following precautions to avoid damage:

Static Sensitivity

Gallium Nitride Devices and Circuits are sensitive to electrostatic discharge (ESD) and can be damaged by static electricity. Proper ESD control techniques should be used when handling these devices.

Компания «Life Electronics» занимается поставками электронных компонентов импортного и отечественного производства от производителей и со складов крупных дистрибьюторов Европы, Америки и Азии.

С конца 2013 года компания активно расширяет линейку поставок компонентов по направлению коаксиальный кабель, кварцевые генераторы и конденсаторы (керамические, пленочные, электролитические), за счёт заключения дистрибьюторских договоров

Мы предлагаем:

- Конкурентоспособные цены и скидки постоянным клиентам.
- Специальные условия для постоянных клиентов.
- Подбор аналогов.
- Поставку компонентов в любых объемах, удовлетворяющих вашим потребностям.
- Приемлемые сроки поставки, возможна ускоренная поставка.
- Доставку товара в любую точку России и стран СНГ.
- Комплексную поставку.
- Работу по проектам и поставку образцов.
- Формирование склада под заказчика.
- Сертификаты соответствия на поставляемую продукцию (по желанию клиента).
- Тестирование поставляемой продукции.
- Поставку компонентов, требующих военную и космическую приемку.
- Входной контроль качества.
- Наличие сертификата ISO.

В составе нашей компании организован Конструкторский отдел, призванный помогать разработчикам, и инженерам.

Конструкторский отдел помогает осуществить:

- Регистрацию проекта у производителя компонентов.
- Техническую поддержку проекта.
- Защиту от снятия компонента с производства.
- Оценку стоимости проекта по компонентам.
- Изготовление тестовой платы монтаж и пусконаладочные работы.



Тел: +7 (812) 336 43 04 (многоканальный)

Email: org@lifeelectronics.ru