

MAX9934

High-Precision, Low-Voltage, Current-Sense Amplifier with Current Output and Chip Select for Multiplexing

General Description

The MAX9934 high-precision, low-voltage, high-side current-sense amplifier is ideal for both bidirectional (charge/discharge) and unidirectional current measurements in battery-powered portable and laptop devices. Input offset voltage (V_{OS}) is a low $10\mu\text{V}$ (max) at $+25^\circ\text{C}$ across the -0.1V to 5.5V input common-mode voltage range, and is independent of V_{CC} . Its precision input specification allows the use of very small sense voltages (typically $\pm 10\text{mV}$ full-scale) for minimally invasive current sensing.

The output of the MAX9934 is a current proportional to input V_{SENSE} and is available in either $25\mu\text{A}/\text{mV}$ or $5\mu\text{A}/\text{mV}$ gain options (G_M) with gain accuracy better than 0.25% (max) at $+25^\circ\text{C}$. A chip select (CS) allows multiplexing of several MAX9934 current outputs to a single microcontroller ADC channel (see the *Typical Operating Circuit*). CS is compatible with 1.8V and 3.3V logic systems.

The MAX9934 is designed to operate from a 2.5V to 3.6V V_{CC} supply, and draws just $120\mu\text{A}$ (typ) quiescent current. When powered down ($V_{CC} = 0$), $RS+$ and $RS-$ draw less than 0.1nA (typ) leakage current to reduce battery load. The MAX9934 is robust and protected from input faults of up to $\pm 6\text{V}$ input differential voltage between $RS+$ and $RS-$.

The MAX9934 is specified for operation over the -40°C to $+125^\circ\text{C}$ temperature range and is available in an 8-pin μMAX° or a 6-bump UCSP™ (1mm x 1.5mm x 0.6mm), making it ideal for space-sensitive applications.

Applications

- PDA's and Smartphones
- MP3 Players
- Sensor Instrumentation Amplifiers
- Notebook PCs and Ultra-Mobile PCs
- Portable Current Monitoring

μMAX is a registered trademark and UCSP is a trademark of Maxim Integrated Products, Inc.

Features

- ◆ **Input Offset Voltage: $10\mu\text{V}$ (max)**
- ◆ **Gain Error Less than 0.25%**
- ◆ **-0.1V to $+5.5\text{V}$ Input Common-Mode Voltage Range**
- ◆ **Chip Select Allows Multiplexing Several MAX9934 Current Monitors to One ADC**
- ◆ **Current Output Allows R_{OUT} Selection for Gain Flexibility**
- ◆ **Single Supply Operation: 2.5V to 3.6V**
- ◆ **Two Gain Options: G_M of $25\mu\text{A}/\text{mV}$ (MAX9934T) and $5\mu\text{A}/\text{mV}$ (MAX9934F)**
- ◆ **Bidirectional or Unidirectional Operation**
- ◆ **Small, 6-Bump UCSP (1mm x 1.5mm x 0.6mm) and 8-Pin μMAX Packages**

Ordering Information

PART	GAIN	PIN-PACKAGE	TOP MARK
MAX9934FART+T	$5\mu\text{A}/\text{mV}$	6 UCSP	AAG
MAX9934FAUA+T	$5\mu\text{A}/\text{mV}$	8 μMAX	—
MAX9934FAUA/V+T	$5\mu\text{A}/\text{mV}$	8 μMAX	AAG
MAX9934TART+T	$25\mu\text{A}/\text{mV}$	6 UCSP	AAF
MAX9934TAUA+T	$25\mu\text{A}/\text{mV}$	8 μMAX	—
MAX9934TAUA/V+T	$25\mu\text{A}/\text{mV}$	8 μMAX	AAF

Note: All devices are specified over the -40°C to $+125^\circ\text{C}$ extended temperature range.

+Denotes a lead(Pb)-free/RoHS-compliant package.

T = Tape and reel.

Typical Operating Circuit



For pricing, delivery, and ordering information, please contact Maxim Direct at 1-888-629-4642, or visit Maxim's website at www.maximintegrated.com.

MAX9934

High-Precision, Low-Voltage, Current-Sense Amplifier with Current Output and Chip Select for Multiplexing

ABSOLUTE MAXIMUM RATINGS

RS+, RS- to GND.....	-0.3V to +6V	Junction-to-Case Thermal Resistance (θ_{JC})	
V _{CC} to GND.....	-0.3V to +4V	(Note 1)	42°C/W
CS, OUT to GND (V _{CC} = 0, or CS < V _{IL}).....	-0.3V to +4V	6-Bump UCSP (derate multilayer 3.9mW/°C	
OUT to GND (CS > V _{IH}).....	-0.3V to V _{CC} + 0.3V	above +70°C).....	308mW
Differential Input Voltage (RS+ - RS-).....	±6V	Junction-to-Ambient Thermal Resistance (θ_{JA})	
Output Short-Circuit Current Duration		(Note 1)	260°C/W
OUT to GND or V _{CC}	Continuous	Operating Temperature Range	-40°C to +125°C
Continuous Input Current into Any Terminal.....	±20mA	Junction Temperature	+150°C
Continuous Power Dissipation (T _A = +70°C)		Storage Temperature Range	-65°C to +160°C
8-Pin μ MAX (derate multilayer 4.8mW/°C		Lead Temperature (μ MAX only, soldering, 10s).....	+300°C
above +70°C).....	388mW	Soldering Temperature (reflow)	+260°C
Junction-to-Ambient Thermal Resistance (θ_{JA})			
(Note 1)	206°C/W		

Note 1: Package thermal resistances were obtained using the method described in JEDEC specification JESD51-7, using a four-layer board. For detailed information on package thermal considerations, refer to www.maximintegrated.com/thermal-tutorial.

Stresses beyond those listed under "Absolute Maximum Ratings" may cause permanent damage to the device. These are stress ratings only, and functional operation of the device at these or any other conditions beyond those indicated in the operational sections of the specifications is not implied. Exposure to absolute maximum rating conditions for extended periods may affect device reliability.

ELECTRICAL CHARACTERISTICS

(V_{CC} = 3.3V, V_{RS+} = V_{RS-} = 3.0V, V_{SENSE} = 0V, V_{CM} = (V_{RS+} + V_{RS-})/2, V_{CS} = 3.3V, R_{OUT} = 10k Ω to GND for unidirectional operation, R_{OUT} = 10k Ω to V_{CC}/2 for bidirectional operation. T_A = -40°C to +125°C, unless otherwise noted. Typical values are at T_A = +25°C.) (Note 2)

PARAMETER	SYMBOL	CONDITIONS	MIN	TYP	MAX	UNITS
DC CHARACTERISTICS						
Input Offset Voltage (Note 3)	V _{OS}	MAX9934T	T _A = +25°C		±10	μ V
			-40°C ≤ T _A ≤ +125°C		±14	
		MAX9934F	T _A = +25°C		±10	
			-40°C ≤ T _A ≤ +125°C		±20	
Input Offset Voltage Drift (Note 3)	V _{OS} /dT	MAX9934T			±60	nV/°C
		MAX9934F			±90	
Common-Mode Input Voltage Range (Average of V _{RS+} and V _{RS-}) (Note 3)	CMVR	Guaranteed by CMRR2	-0.1		+5.5	V
Common-Mode Rejection Ratio (Note 3)	CMRR1	0 ≤ V _{CM} ≤ V _{CC} - 0.2V (MAX9934F)	T _A = +25°C	128	134	dB
			-40°C ≤ T _A ≤ +125°C	112		
		0 ≤ V _{CM} ≤ V _{CC} - 0.2V (MAX9934T)	T _A = +25°C	128	135	
			-40°C ≤ T _A ≤ +125°C	109		
	CMRR2	-0.1 ≤ V _{CM} ≤ 5.5V (MAX9934F)	T _A = +25°C	119	125	
			-40°C ≤ T _A ≤ +125°C	104		
-0.1 ≤ V _{CM} ≤ 5.5V (MAX9934T)	T _A = +25°C	98	113			
	-40°C ≤ T _A ≤ +125°C	98				

MAX9934

High-Precision, Low-Voltage, Current-Sense Amplifier with Current Output and Chip Select for Multiplexing

ELECTRICAL CHARACTERISTICS (continued)

($V_{CC} = 3.3V$, $V_{RS+} = V_{RS-} = 3.0V$, $V_{SENSE} = 0V$, $V_{CM} = (V_{RS+} + V_{RS-})/2$, $V_{CS} = 3.3V$, $R_{OUT} = 10k\Omega$ to GND for unidirectional operation, $R_{OUT} = 10k\Omega$ to $V_{CC}/2$ for bidirectional operation. $T_A = -40^{\circ}C$ to $+125^{\circ}C$, unless otherwise noted. Typical values are at $T_A = +25^{\circ}C$.) (Note 2)

PARAMETER	SYMBOL	CONDITIONS	MIN	TYP	MAX	UNITS
Current Gain (Transconductance)	G _M	MAX9934T		25		μA/mV
		MAX9934F		5		
Current Gain Error (Note 4)	G _{ME}	MAX9934T	$T_A = +25^{\circ}C$		±0.25	%
			$-40^{\circ}C \leq T_A \leq +125^{\circ}C$		±2.0	
		MAX9934F	$T_A = +25^{\circ}C$		±0.25	
			$-40^{\circ}C \leq T_A \leq +125^{\circ}C$		±2.4	
Gain Error Drift	G _{ME} /dT	MAX9934T			±200	ppm/°C
		MAX9934F			±240	
Input-Bias Current for RS+	I _{BRS+}	$V_{RS+} = V_{RS-} = 5.5V$		0.1	100	nA
Input-Bias Current for RS-	I _{BRS-}	$V_{RS+} = V_{RS-} \leq V_{CC} - 0.2V$		0.1	100	nA
		$V_{RS+} = V_{RS-} = 5.5V$		35	60	μA
Input Leakage Current	I _{LEK}	$V_{CC} = 0V$, $V_{RS+} = V_{RS-} = 5.5V$		0.1	100	nA
DC CHARACTERISTICS						
Minimum Current for Output Low	I _{OL}	Unidirectional, $V_{OL} = I_{OL} \times R_{OUT}$		1	100	nA
Output-Voltage Range (MAX9934T)	V _{OH}	$I_{OUT} = +600\mu A$, $V_{OH} = V_{CC} - V_{OUT}$		0.1	0.25	V
	V _{OL}	$I_{OUT} = -600\mu A$, bidirectional		0.15	0.25	
Output-Voltage Range (MAX9934F)	V _{OH}	$I_{OUT} = +375\mu A$, $V_{OH} = V_{CC} - V_{OUT}$		0.18	0.30	V
	V _{OL}	$I_{OUT} = -375\mu A$, bidirectional		0.18	0.26	
Deselected Amplifier Output Leakage	I _{OLK}	$V_{CS} = 0V$, $V_{OUT} = 3.6V$, and $0 \leq V_{CC} \leq 3.6V$		0.1	100	nA
LOGIC I/O (CS)						
Input Voltage Low CS	V _{IL}		0.54			V
Input Voltage High CS	V _{IH}				1.26	V
Input Current CS	I _{IL} , I _{IH}	$0 \leq V_{CS} \leq V_{CC}$		0.1	100	nA
POWER SUPPLY						
Supply-Voltage Range	V _{CC}	Guaranteed by PSRR	2.5		3.6	V
Power-Supply Rejection Ratio	PSRR	$2.5V \leq V_{CC} \leq 3.6V$, $V_{RS+} = V_{RS-} = 2V$ (Note 3)	110	120		dB
Supply Current	I _{CC}	$V_{CC} = 3.3V$, $R_{OUT} = 10k\Omega$ to $3.3V$, $V_{RS+} = V_{RS-} = 3.1V$		120	230	μA
Supply Current, Output Deselected	I _{CC,DES}	$V_{CS} = 0V$, $R_{OUT} = 10k\Omega$ to $3.3V$, $V_{RS+} = V_{RS-} = 3.1V$		120	210	μA
AC CHARACTERISTICS (C_L = 1000pF)						
Amplifier Bandwidth	BW	MAX9934T G _M = 25μA/mV, V _{SENSE} = 5mV		1.5		kHz
		MAX9934F G _M = 5μA/mV, V _{SENSE} = 25mV		5		

MAX9934

High-Precision, Low-Voltage, Current-Sense Amplifier with Current Output and Chip Select for Multiplexing

ELECTRICAL CHARACTERISTICS (continued)

($V_{CC} = 3.3V$, $V_{RS+} = V_{RS-} = 3.0V$, $V_{SENSE} = 0V$, $V_{CM} = (V_{RS+} + V_{RS-})/2$, $V_{CS} = 3.3V$, $R_{OUT} = 10k\Omega$ to GND for unidirectional operation, $R_{OUT} = 10k\Omega$ to $V_{CC}/2$ for bidirectional operation. $T_A = -40^{\circ}C$ to $+125^{\circ}C$, unless otherwise noted. Typical values are at $T_A = +25^{\circ}C$.) (Note 2)

PARAMETER	SYMBOL	CONDITIONS	MIN	TYP	MAX	UNITS
Output Settling Time	t _s	0.1% final value, Figure 1, MAX9934T		670		μs
		0.1% final value, Figure 1, MAX9934F		220		
Output Select Time	t _{zH}	Output to 0.1% final value, Figure 2, MAX9934T		150		μs
		Output to 0.1% final value, Figure 2, MAX9934F		80		
Output Deselect Time	t _{Hz}	Output step of 100mV, C _L = 10pF, Figure 2		2		μs
Power-Down Time	t _{PD}	Output step of -100mV, C _L = 10pF, V _{CC} > 2.5V		2		μs
Power-Up Time	t _{PU}	0.1% final value, Figure 3, MAX9934T		300		μs
		0.1% final value, Figure 3, MAX9934F		200		

Note 2: All devices are 100% production tested at $T_A = +25^{\circ}C$. Unless otherwise noted, specifications overtemperature are guaranteed by design.

Note 3: Guaranteed by design. Thermocouple, contact resistance, RS- input-bias current, and leakage effects preclude measurement of this parameter during production testing. Devices are screened during production testing to eliminate defective units.

Note 4: Gain error tested in unidirectional mode: $0.2V \leq V_{OUT} \leq 3.1V$ for the MAX9934T; $0.25V \leq V_{OUT} \leq 2.5V$ for the MAX9934F.

MAX9934

High-Precision, Low-Voltage, Current-Sense Amplifier with Current Output and Chip Select for Multiplexing

Typical Operating Characteristics

($V_{CC} = 3.3V$, $V_{RS+} = V_{RS-} = 3.0V$, $V_{SENSE} = 0V$, $C_L = 1000pF$, $R_{OUT} = 10k\Omega$ to GND for unidirectional operation, $R_{OUT} = 10k\Omega$ to $V_{CC}/2$ for bidirectional operation. $T_A = +25^\circ C$, unless otherwise noted.)

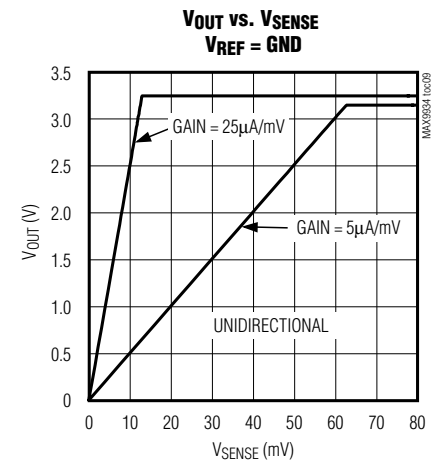
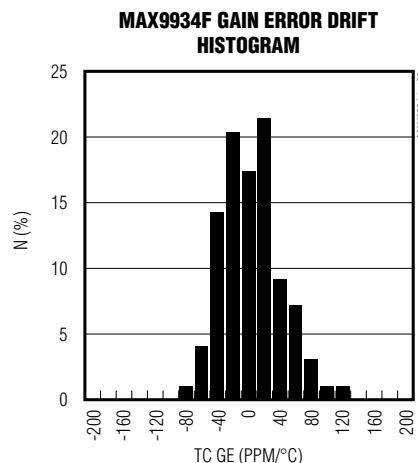
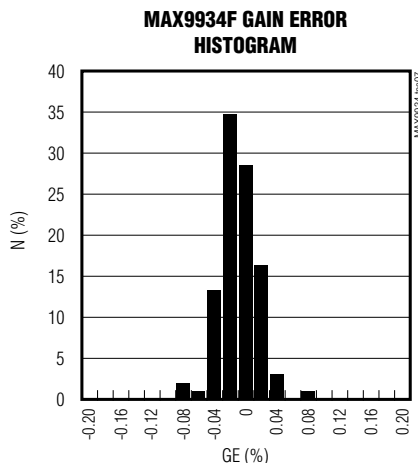
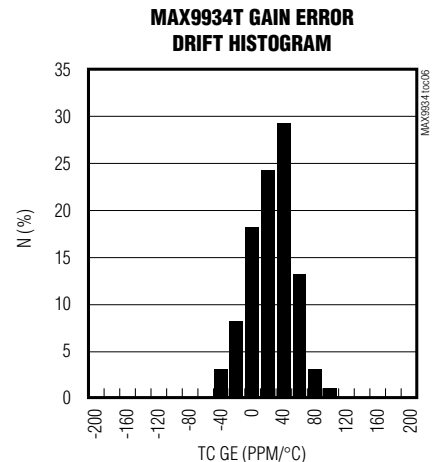
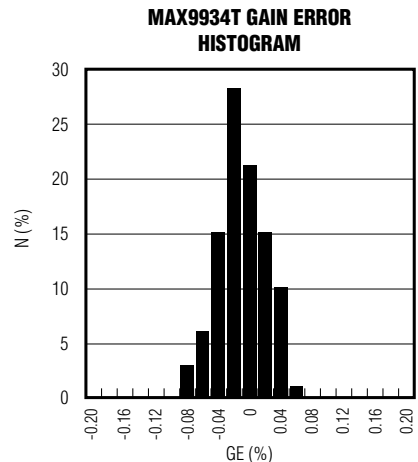
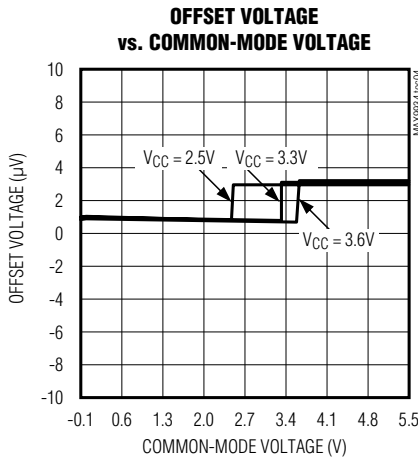
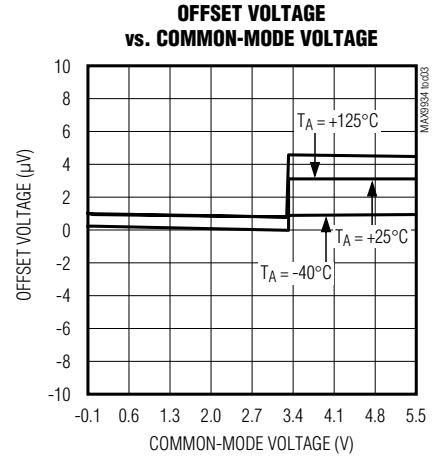
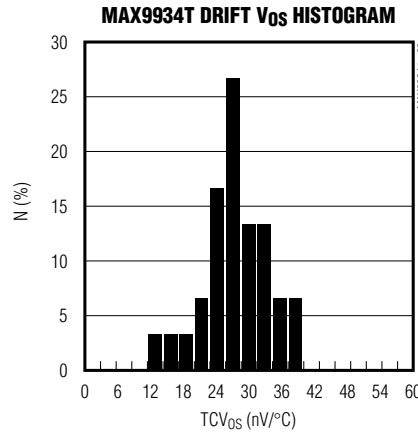
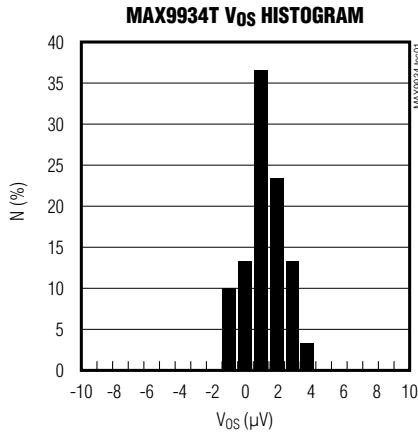

MAX9934

High-Precision, Low-Voltage, Current-Sense Amplifier with Current Output and Chip Select for Multiplexing

Typical Operating Characteristics (continued)

($V_{CC} = 3.3V$, $V_{RS+} = V_{RS-} = 3.0V$, $V_{SENSE} = 0V$, $C_L = 1000pF$, $R_{OUT} = 10k\Omega$ to GND for unidirectional operation, $R_{OUT} = 10k\Omega$ to $V_{CC}/2$ for bidirectional operation. $T_A = +25^\circ C$, unless otherwise noted.)

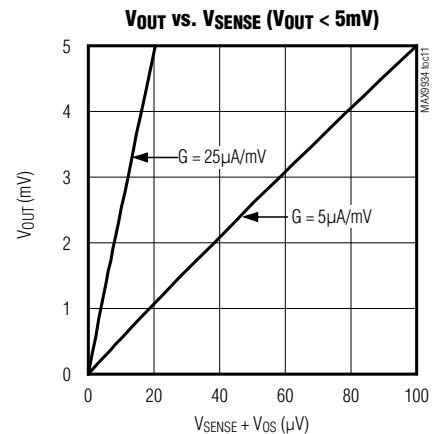

MAX9934

High-Precision, Low-Voltage, Current-Sense Amplifier with Current Output and Chip Select for Multiplexing

Typical Operating Characteristics (continued)

($V_{CC} = 3.3V$, $V_{RS+} = V_{RS-} = 3.0V$, $V_{SENSE} = 0V$, $C_L = 1000pF$, $R_{OUT} = 10k\Omega$ to GND for unidirectional operation, $R_{OUT} = 10k\Omega$ to $V_{CC}/2$ for bidirectional operation. $T_A = +25^\circ C$, unless otherwise noted.)



MAX9934

High-Precision, Low-Voltage, Current-Sense Amplifier with Current Output and Chip Select for Multiplexing

Typical Operating Characteristics (continued)

($V_{CC} = 3.3V$, $V_{RS+} = V_{RS-} = 3.0V$, $V_{SENSE} = 0V$, $C_L = 1000pF$, $R_{OUT} = 10k\Omega$ to GND for unidirectional operation, $R_{OUT} = 10k\Omega$ to $V_{CC}/2$ for bidirectional operation. $T_A = +25^\circ C$, unless otherwise noted.)

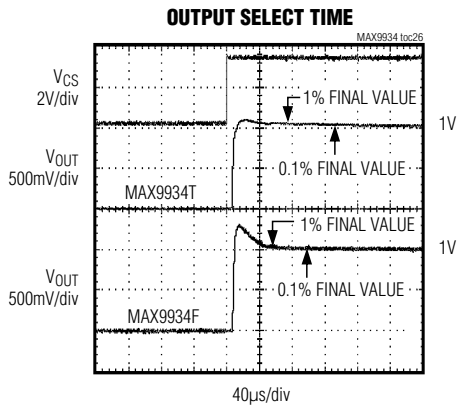
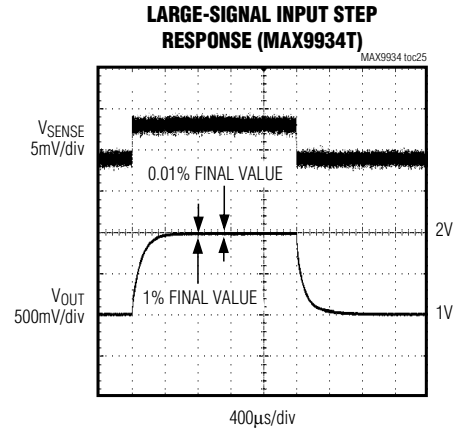
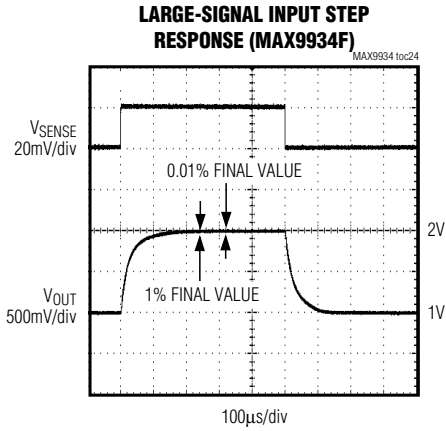

MAX9934

High-Precision, Low-Voltage, Current-Sense Amplifier with Current Output and Chip Select for Multiplexing

Typical Operating Characteristics (continued)

($V_{CC} = 3.3V$, $V_{RS+} = V_{RS-} = 3.0V$, $V_{SENSE} = 0V$, $C_L = 1000pF$, $R_{OUT} = 10k\Omega$ to GND for unidirectional operation, $R_{OUT} = 10k\Omega$ to $V_{CC}/2$ for bidirectional operation. $T_A = +25^\circ C$, unless otherwise noted.)

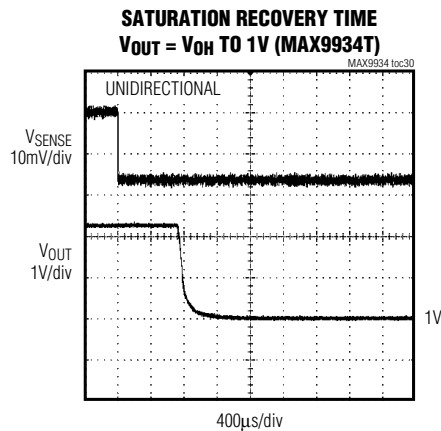
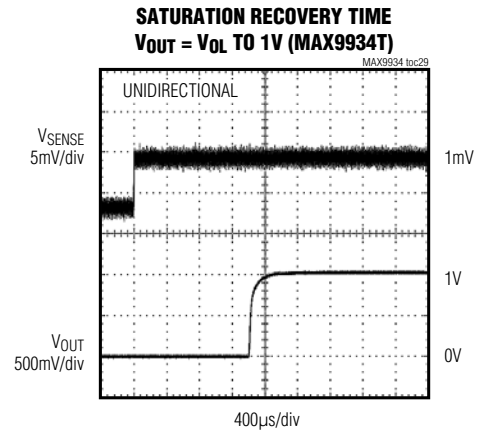
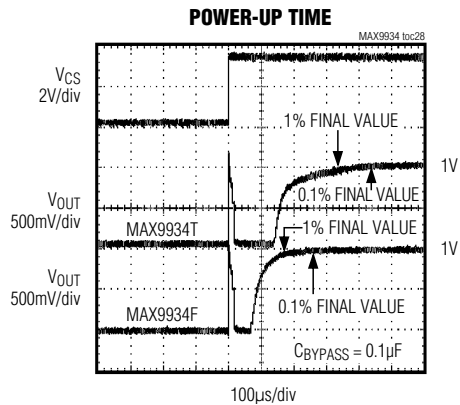

MAX9934

High-Precision, Low-Voltage, Current-Sense Amplifier with Current Output and Chip Select for Multiplexing

Pin Description

PIN/BUMP		NAME	FUNCTION
UCSP	μMAX		
A1	1	VCC	Power Supply
A2	2	OUT	Current Output. OUT provides an output current proportional to input VSENSE. Connect an external resistor (ROUT) from OUT to GND for unidirectional sensing or to an external reference voltage for bidirectional sensing.
A3	3	GND	Ground
B1	8	RS+	Sense Resistor Power Side Connection
B2	7	RS-	Sense Resistor Load Side Connection
B3	6	CS	Chip-Select Input. Drive CS high to enable OUT, drive CS low to put OUT in a high-impedance state.
—	4, 5	N.C.	No Connection. Not internally connected.

Functional Diagram



Figure 1. Output Settling Time

Detailed Description

The MAX9934 high-side, current-sense amplifier monitors current through an external current-sense resistor by amplifying the voltage across the resistor (VSENSE) to create an output current (IOUT). An output voltage (VOUT) then develops across the external output resistor (ROUT). See the *Typical Operating Circuit*.

The MAX9934 uses precision amplifier design techniques to achieve a low-input offset voltage of less than 10μV. These techniques also enable extremely low-input offset voltage drift over time and temperature and

achieve gain error of less than 0.25%. The precision VOS specification allows accurate current measurements with a low-value current-sense resistor, thus reducing power dissipation in battery-powered systems, as well as load-regulation issues in low-voltage DC power supplies.

The MAX9934 high-side current-sense amplifier features a -0.1V to +5.5V input common-mode range that is independent of supply voltage (VCC). This ability to sense at voltages beyond the supply rail allows the monitoring of currents out of a power supply even in a shorted condition, while also enabling high-side current sensing at voltages greater than the MAX9934 supply

High-Precision, Low-Voltage, Current-Sense Amplifier with Current Output and Chip Select for Multiplexing



Figure 2. Output Select and Deselect Time



Figure 3. Output Power-Up and Power-Down Time

voltage. Further, when $V_{CC} = 0$, the amplifier maintains an extremely high impedance on both its inputs and output, up to the maximum operating voltages (see the *Absolute Maximum Ratings* section).

The MAX9934 features a CS that can be used to deselect its output current-source. This allows multiple current-sense amplifier outputs to be multiplexed into a single ADC channel with a single R_{OUT} . See the *Chip Select Functionality for Multiplexed Systems* section for more details.

The *Functional Diagram* shows the internal operation of the MAX9934. At its core is the indirect current-feedback architecture. This architecture uses two matched transconductance amplifiers to convert their input differential voltages into an output current. A high-gain feedback amplifier forces the voltage drop across R_{GAIN} to be the same as the input differential voltage. The internal resistor (R_{GAIN}) sets the transconductance gain of the device. Both input and output transconductance amplifiers feature excellent common-mode rejection characteristics, helping the MAX9934 to deliver industry-leading precision specifications over the full common-mode range.

Applications Information

Advantages of Current-Output Architecture

The transconductance transfer function of the MAX9934 converts input differential voltage to an output current. An output termination resistor, R_{OUT} , then converts this current to a voltage. In a large circuit board with multiple ground planes and multiple current-measurement rails spread across the board, traditional voltage-output current-sense amplifiers become susceptible to ground-bounce errors. These errors occur because the local ground at the location of the current-sense amplifier is at a slightly different voltage than the local ground voltage at the ADC that is sampling the voltage. The MAX9934 allows accurate measurements to be made even in the presence of system ground noise. This is achieved by sending the output information as a current, and by terminating to the ADC ground.

A further advantage of current-output systems is the flexibility in setting final voltage gain of the device. Since the final voltage gain is user-controlled by the choice of output termination resistor, it is easy to optimize the monitored load current range to the ADC input voltage range. It is no longer necessary to increase the size of the sense resistor (also increasing power dissipation) as necessary with fixed-gain, voltage-output current-sense amplifiers.

MAX9934

High-Precision, Low-Voltage, Current-Sense Amplifier with Current Output and Chip Select for Multiplexing

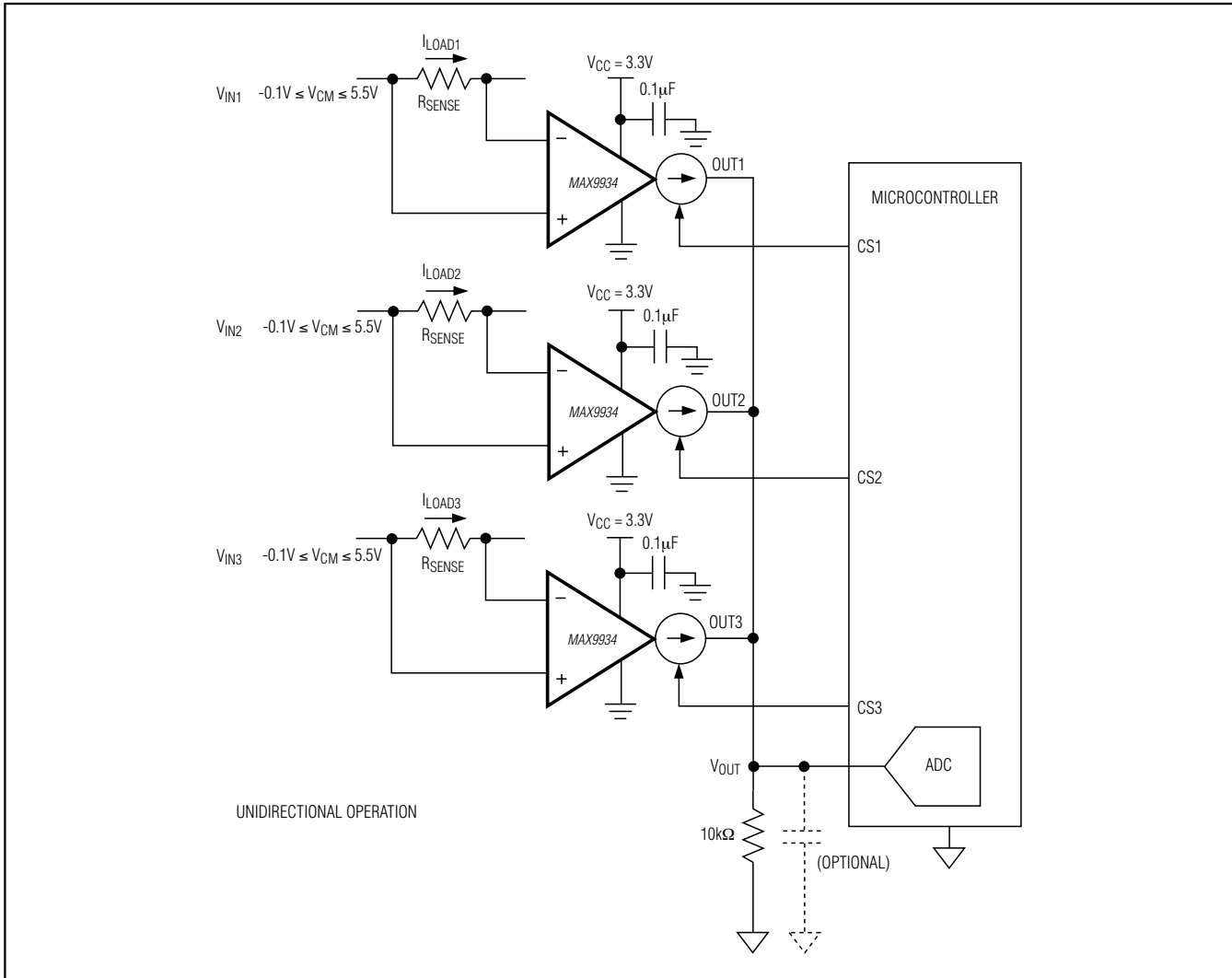

Figure 4. Typical Application Circuit Showing Chip-Select Multiplexing

Chip-Select Functionality for Multiplexed Systems

The MAX9934 features a CS that can be used to deselect the output current - source achieving a high-impedance output with 0.1nA leakage current. Thus, different supply voltages can be used to power different MAX9934 devices that are multiplexed on the same bus. This technique makes it possible for advanced current monitoring and power-management schemes to be implemented when a limited number of ADC channels are available.

In a multiplexed arrangement, each MAX9934 is typically placed near the load being monitored and all

amplifier outputs are connected in common to a single load resistor located adjacent to the monitoring ADC. This resistor is terminated to the ADC ground reference as shown in Figure 4 for unidirectional applications.

Figure 5 shows a bidirectional multiplexed application. Terminating the external resistor at the ground reference of the ADC minimizes errors due to ground shift as discussed in the *Advantages of Current-Output Architecture* section.

The MAX9934 is capable of both sourcing and sinking current from OUT, and thus can be used as a precision bidirectional current-sense amplifier. To enable this functionality, terminate ROUT to a midrail voltage VBIAS.

MAX9934

High-Precision, Low-Voltage, Current-Sense Amplifier with Current Output and Chip Select for Multiplexing



Figure 5. Bidirectional Multiplexed Operation

In Figure 5, V_{OUT} is equal to V_{BIAS} when the sum of all outputs is zero. For positive input-sense voltages, the MAX9934 sources current causing its output voltage to rise above V_{BIAS} . For negative input-sense voltages, the MAX9934 sinks current causing its output voltage to be lower than V_{BIAS} , thus allowing bidirectional current sensing.

Since the ADC reference voltage, V_{REF} , determines the full-scale reading, a common choice for V_{BIAS} is $V_{REF}/2$. The current output makes it possible to use a simple resistor-divider from V_{REF} to GND to generate V_{BIAS} . The output resistance for gain calculation is the parallel combination of the two resistors. For example, if two equal value resistors, R , are used to generate a $V_{BIAS} = V_{REF}/2$, the output termination resistance for gain calculation is $R_{OUT} = R/2$. See Figure 5.

MAX9934

High-Precision, Low-Voltage, Current-Sense Amplifier with Current Output and Chip Select for Multiplexing

A MAX9934 can be deselected by either forcing V_{CS} low as shown in Figures 4 and 5, or by making $V_{CC} = 0V$ as shown in Figure 6. In all these conditions, the MAX9934 maintains a high-impedance output with 0.1nA (typ) leakage current. In this state, OUT can rise above V_{CC} if necessary. Thus, different supply voltages can be used to power different MAX9934 devices that are multiplexed on the same OUT bus. Multiplexing by forcing the MAX9934 to be powered down ($V_{CC} = 0V$) reduces its supply current to zero to help extend battery life in portable applications.

Choosing R_{SENSE} and R_{OUT}

In the current-sense application, the monitored load current (I_{LOAD}) develops a sense voltage (V_{SENSE}) across a current-sense resistor (R_{SENSE}). The MAX9934 sources or sinks an output current that is proportional to V_{SENSE} . Finally, the MAX9934 output current is provided to an output resistor (R_{OUT}) to develop an output voltage across R_{OUT} that is proportional to the sensed load current.



Figure 6. Multiplexed Amplifiers with Power Saving

High-Precision, Low-Voltage, Current-Sense Amplifier with Current Output and Chip Select for Multiplexing

Three components are to be selected to optimize the current-sense system: R_{SENSE} , R_{OUT} , and the MAX9934 gain option ($G_M = 25\mu A/mV$ or $5\mu A/mV$). Tables 1 and 2 are gain tables for unidirectional and bidirectional operation, respectively. They offer a few examples for both MAX9934 options having an output range of 3.1V unidirectional and $\pm 1.65V$ bidirectional.

Note that the output current of the MAX9934 adds to its quiescent current. This can be calculated as follows:

$$I_{OUT,MAX} = V_{OUT,MAX}/R_{OUT}$$

When selecting R_{SENSE} , consider the expected magnitude of I_{LOAD} and the required V_{SENSE} to manage power dissipation in R_{SENSE} :

$$R_{SENSE} = V_{SENSE,MAX}/I_{LOAD,MAX}$$

R_{SENSE} is typically a low-value resistor specifically designed for current-sense applications.

Finally, in selecting the appropriate MAX9934 gain option (G_M), consider both the required V_{SENSE} and I_{OUT} :

$$G_M = I_{OUT,MAX}/V_{SENSE,MAX}$$

Once all three component values have been selected in the current-sense application, the system performance is represented by:

$$V_{SENSE} = R_{SENSE} \times I_{LOAD}$$

and

$$V_{OUT} = V_{SENSE} \times G_M \times R_{OUT}$$

Accuracy

In a first-order analysis of accuracy there are two MAX9934 specifications that contribute to output error, input offset (V_{OS}) and gain error (GE). The MAX9934 has a maximum V_{OS} of $10\mu V$ and a maximum GE of 0.25%.

Note that the tolerance and temperature coefficient of the chosen resistors directly affect the precision of any measurement system.

Efficiency and Power Dissipation

At high-current levels, the I^2R losses in R_{SENSE} can be significant. Take this into consideration when choosing the resistor value and its power dissipation (wattage) rating. Also, the sense resistor's value drifts if it is allowed to self-heat excessively. The precision V_{OS} of the MAX9934 allows the use of a small sense resistor to reduce power dissipation and eliminate hot spots.

Kelvin Contacts

Due to the high currents that flow through R_{SENSE} , take care to prevent trace resistance in the load current path from causing errors in the sense voltage. Use a four terminal current-sense resistor or Kelvin contacts (force and sense) PCB layout techniques.

Table 1. Unidirectional Gain Table*

PART	V_{SENSE} (mV)	OUTPUT CURRENT (μA)	R_{OUT} (k Ω)	GAIN (V/V)
MAX9934T	12.4	310	10	250
	24.8	620	5	125
MAX9934F	62	310	10	50
	75	375	8	40

*All calculations were made with $V_{CC} = 3.3V$ and $V_{OUT(MAX)} = V_{CC} - V_{OH} = 3.1V$.

Table 2. Bidirectional Gain Table*

PART	V_{SENSE} (mV)	OUTPUT CURRENT (μA)	R_{OUT} (k Ω)	GAIN (V/V)
MAX9934T	± 5.8	± 145	10	250
	± 11.6	± 290	5	125
	± 24	± 600	2.4	60
MAX9934F	± 29	± 145	10	50
	± 58	± 290	5	25
	± 72	± 360	4	20

*All calculations were made with $V_{CC} = 3.3V$, $V_{OUT(MAX)} = V_{CC} - V_{OH} = 3.1V$, $V_{OUT(MIN)} = V_{OL}$, and OUT connected to an external reference voltage of $V_{REF} = 1.65V$ through R_{OUT} .

Interfacing the MAX9934 to SAR ADCs

Since the MAX9934 is essentially a high-output impedance current-source, its output termination resistor, R_{OUT} , acts like a source impedance when driving an ADC channel. Most successive approximation register (SAR) architecture ADCs specify a maximum source resistance to avoid compromising the accuracy of their readings. Choose the output termination resistor R_{OUT} such that it is less than that required by the ADC specification (10k Ω or less). If the R_{OUT} is larger than the source resistance specified, the ADC internal sampling capacitor can momentarily load the amplifier output and cause a drop in the voltage reading.

If R_{OUT} is larger than the source resistance specified, consider using a ceramic capacitor from ADC input to GND. This input capacitor supplies momentary charge to the internal ADC sampling capacitor, helping hold V_{OUT} constant to within $\pm 1/2$ LSB during the acquisition period. Use of this capacitor reduces the noise in the output signal to improve sensitivity of measurement.

MAX9934

High-Precision, Low-Voltage, Current-Sense Amplifier with Current Output and Chip Select for Multiplexing

Effect of Input-Bias Currents

The MAX9934 has extremely low CMOS input-bias currents at both RS+ and RS- (0.1nA) when the input common-mode voltage is less than the supply voltage. When the input common-mode voltage becomes higher than the supply voltage, it draws the input stage operating current from RS-, 35 μ A (typ). RS+ maintains its CMOS input characteristics.

Low-input-bias currents are extremely useful in design of input filters for current-sense amplifiers. Input differential filters are sometimes required to average out rapidly varying load currents. An example of such load currents are those consumed by a processor, or switching power supply. Large bias and offset currents can interact with resistors used in these external filters to generate large input offset voltages and gain errors. For more detailed information, see Application Note AN3888: *Performance of Current-Sense Amplifiers with Input Series Resistors*.

Due to the low-input-bias currents, resistors as large as 10k Ω can be easily used without impact on error specifications with the MAX9934. For applications where the input common-mode voltage is below V_{CC}, a balanced differential filter can be used. For applications where the input common-mode voltage extends above V_{CC}, use a one-sided filter with a capacitor between RS+ and RS-, and a filter resistor in series with RS+ to maintain the excellent performance of the MAX9934. See Figure 7.

PCB Layout

For applications where the input common-mode voltage extends above V_{CC}, trace resistance between R_{SENSE} and RS- influences the effective V_{OS} error due to the voltage drop developed across the trace resistance by the 35 μ A input bias current at RS-.

Monitoring Very Low Currents

The accuracy of the MAX9934 leads to a wide dynamic range. This applies to both unidirectional mode and bidirectional mode. This is made possible in the unidirectional mode because the output maintains gain accuracy below 1mV as shown in the V_{OUT} vs. V_{SENSE} (V_{OUT} < 5mV) graph in the *Typical Operating Char-*

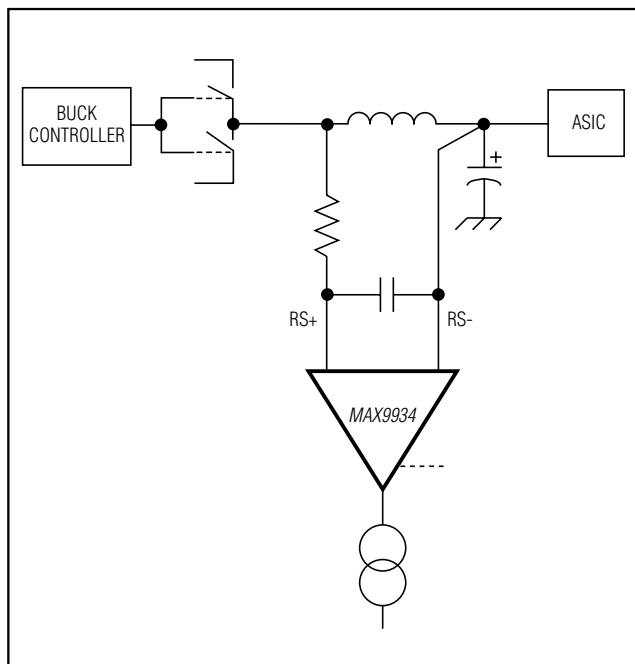

Figure 7. One-Sided Input Filter

acteristics. Extending the useful output below 1mV makes it possible for the MAX9934 to accurately monitor very low currents.

Use as Precision Instrumentation Amplifier

When the input common-mode voltage is below V_{CC}, the input bias current of the RS- input drops to the 10pA range, the same range as the RS+ input. This low-input-bias current in combination with the rail-to-rail common-mode input range, the extremely high common-mode rejection, and low V_{OS} of the MAX9934 make it ideally suited for use as a precision instrumentation amplifier. In addition, the MAX9934 is stable into an infinite capacitive load, allowing filtering flexibility.

Figure 8 shows the MAX9934 in a multiplexed arrangement of strain-gauge amplifiers.

MAX9934

High-Precision, Low-Voltage, Current-Sense Amplifier with Current Output and Chip Select for Multiplexing

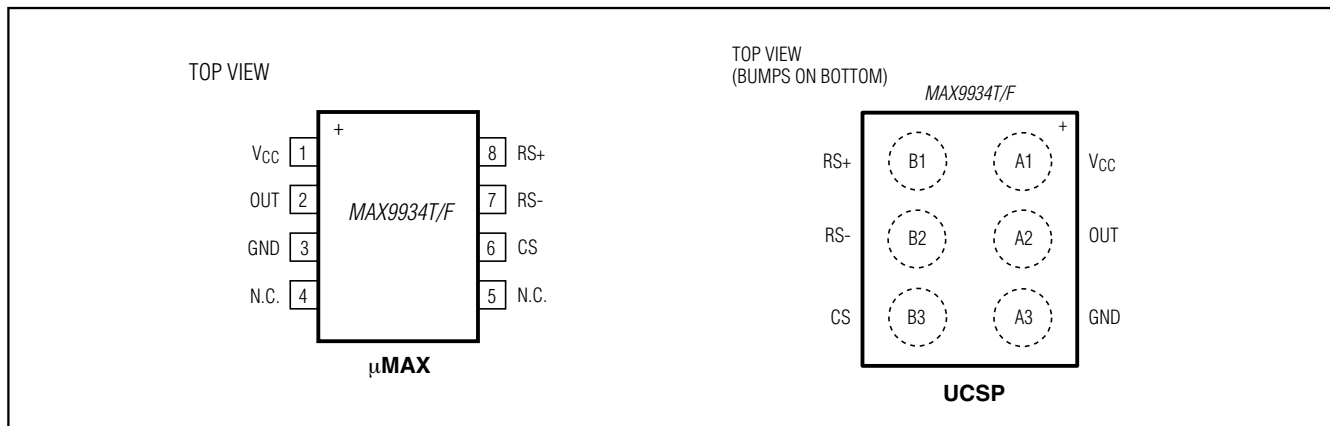

Figure 8. Multiplexed, Strain-Gauge Amplifier Operation

MAX9934

High-Precision, Low-Voltage, Current-Sense Amplifier with Current Output and Chip Select for Multiplexing

Pin Configurations



Chip Information

PROCESS: BiCMOS

Package Information

For the latest package outline information and land patterns (footprints), go to www.maximintegrated.com/packages. Note that a "+", "#", or "-" in the package code indicates RoHS status only. Package drawings may show a different suffix character, but the drawing pertains to the package regardless of RoHS status.

PACKAGE TYPE	PACKAGE CODE	OUTLINE NO.	LAND PATTERN NO.
2x3 UCSP	R61A1+1	21-0228	—
8 μMAX	U8+1	21-0036	90-0092

MAX9934

High-Precision, Low-Voltage, Current-Sense Amplifier with Current Output and Chip Select for Multiplexing

Revision History

REVISION NUMBER	REVISION DATE	DESCRIPTION	PAGES CHANGED
0	10/09	Initial release	—
1	1/10	Removed μ DFN package option	1–10, 18
2	4/10	Removed future product references and updated lead temperature	1, 2
3	11/12	Added automotive packages to <i>Ordering Information</i>	1



Maxim Integrated cannot assume responsibility for use of any circuitry other than circuitry entirely embodied in a Maxim Integrated product. No circuit patent licenses are implied. Maxim Integrated reserves the right to change the circuitry and specifications without notice at any time. The parametric values (min and max limits) shown in the Electrical Characteristics table are guaranteed. Other parametric values quoted in this data sheet are provided for guidance.

Maxim Integrated 160 Rio Robles, San Jose, CA 95134 USA 1-408-601-1000

19

Компания «Life Electronics» занимается поставками электронных компонентов импортного и отечественного производства от производителей и со складов крупных дистрибьюторов Европы, Америки и Азии.

С конца 2013 года компания активно расширяет линейку поставок компонентов по направлению коаксиальный кабель, кварцевые генераторы и конденсаторы (керамические, пленочные, электролитические), за счёт заключения дистрибьюторских договоров

Мы предлагаем:

- Конкурентоспособные цены и скидки постоянным клиентам.
- Специальные условия для постоянных клиентов.
- Подбор аналогов.
- Поставку компонентов в любых объемах, удовлетворяющих вашим потребностям.
- Приемлемые сроки поставки, возможна ускоренная поставка.
- Доставку товара в любую точку России и стран СНГ.
- Комплексную поставку.
- Работу по проектам и поставку образцов.
- Формирование склада под заказчика.
- Сертификаты соответствия на поставляемую продукцию (по желанию клиента).
- Тестирование поставляемой продукции.
- Поставку компонентов, требующих военную и космическую приемку.
- Входной контроль качества.
- Наличие сертификата ISO.

В составе нашей компании организован Конструкторский отдел, призванный помогать разработчикам, и инженерам.

Конструкторский отдел помогает осуществить:

- Регистрацию проекта у производителя компонентов.
- Техническую поддержку проекта.
- Защиту от снятия компонента с производства.
- Оценку стоимости проекта по компонентам.
- Изготовление тестовой платы монтаж и пусконаладочные работы.



Тел: +7 (812) 336 43 04 (многоканальный)

Email: org@lifeelectronics.ru