

# Inductors for Power Circuits

Wound/STD • magnetic shielded

## SPM series

Type:            **SPM3012 (3.2x3.0 mm)**  
                     **SPM5030 (5.2x5.0 mm)**  
                     **SPM6530 (7.1x6.5 mm)**

Issue date:     September 2011

- All specifications are subject to change without notice.
  - Conformity to RoHS Directive: This means that, in conformity with EU Directive 2002/95/EC, lead, cadmium, mercury, hexavalent chromium, and specific bromine-based flame retardants, PBB and PBDE, have not been used, except for exempted applications.
-

# Inductors for Power Circuits

## Wound/STD • Magnetic Shielded

Conformity to RoHS Directive

### SPM Series SPM3012

The SPM3012 is a large-current SMD power inductor that uses a magnetic metal material. In addition to the conventional SPM6530 and SPM5030 products, the SPM Series now includes this 3×3.2mm product with a maximum height of 1.2mm.

#### FEATURES

- Small and low profile design.  
Size: 3.2×3.0mm.  
Height: 1.2mm max.
- Uses a magnetic metal material with a high magnetic flux density.
- Has a high curie temperature, which ensures a wide operating temperature range.
- Available for automatic mounting in tape and reel package.

#### APPLICATIONS

Cellular phones, note book type computers, etc.

#### PRODUCT IDENTIFICATION

SPM	3012	T	- 1R0	- M
(1)	(2)	(3)	(4)	(5)

(1) Series name

(2) Dimensions L×H

3012	3.0×1.2mm max.
------	----------------

(3) Packaging style

T	Embossed carrier tape
---	-----------------------

(4) Inductance value

1R0	1.0μH
-----	-------

(5) Inductance tolerance

M	±20%
---	------

#### PACKAGING STYLE AND QUANTITIES

Packaging style	Quantity
Taping	2000 pieces/reel

#### SHAPES AND DIMENSIONS

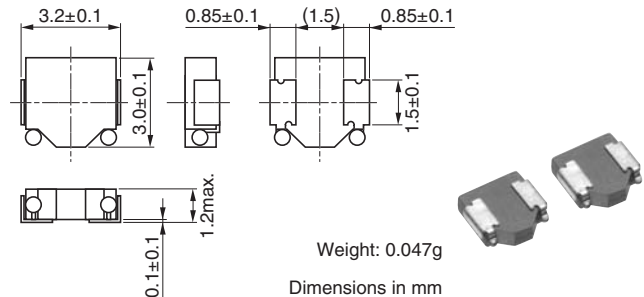

#### RECOMMENDED PC BOARD PATTERN

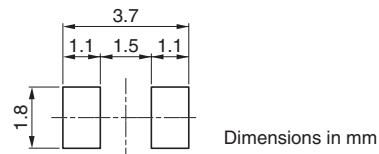

#### CIRCUIT DIAGRAM



#### RECOMMENDED SOLDERING CONDITION

##### REFLOW SOLDERING

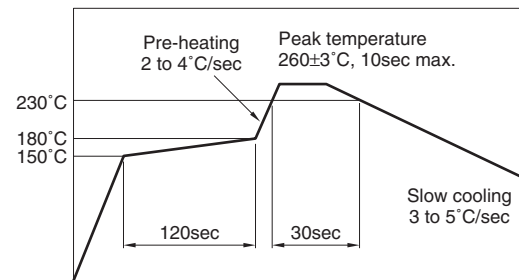

#### HANDLING AND PRECAUTIONS

- Please contact us before cleaning this product.
- Maintain a safe distance between this product and other components according to the working voltage.
- If this product is left in a humid environment for a long period of time, rust may appear on the surface. However, this does not affect performance.

• Conformity to RoHS Directive: This means that, in conformity with EU Directive 2002/95/EC, lead, cadmium, mercury, hexavalent chromium, and specific bromine-based flame retardants, PBB and PBDE, have not been used, except for exempted applications.

• Please contact our Sales office when your application is considered the following:  
The device's failure or malfunction may directly endanger human life (e.g. application for automobile/aircraft/medical/nuclear power devices, etc.)

• All specifications are subject to change without notice.

## ELECTRICAL CHARACTERISTICS

Part No.	Inductance ( $\mu\text{H}$ )	Tolerance (%)	Test frequency (kHz)	DC resistance( $\text{m}\Omega$ )		Rated current(A)*		
				max.	typ.	Based on inductance change		Based on temperature rise
						max.	typ.	typ.
SPM3012T-1R0M	1.0	$\pm 20$	100	65	57	3.4	5.4	2.8
SPM3012T-1R5M	1.5	$\pm 20$	100	90	77	2.8	4.7	2.5
SPM3012T-2R2M	2.2	$\pm 20$	100	115	100	2.5	3.4	2.2
SPM3012T-3R3M	3.3	$\pm 20$	100	210	183	1.8	2.8	1.5
SPM3012T-4R7M	4.7	$\pm 20$	100	270	232	1.5	2.6	1.3

\* Rated current: Value obtained when current flows and the temperature has risen to 40°C or when DC current flows and the nominal value of inductance has fallen by 30%, whichever is smaller.

• Operating temperature range: -40 to +125°C (Including self-temperature rise)

## TYPICAL ELECTRICAL CHARACTERISTICS

### INDUCTANCE CHANGE vs. DC SUPERPOSITION CHARACTERISTICS

#### SPM3012T-1R0M

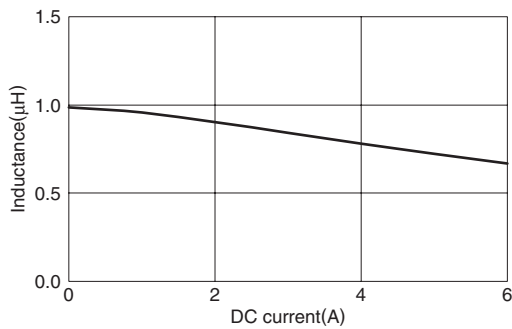

#### SPM3012T-1R5M

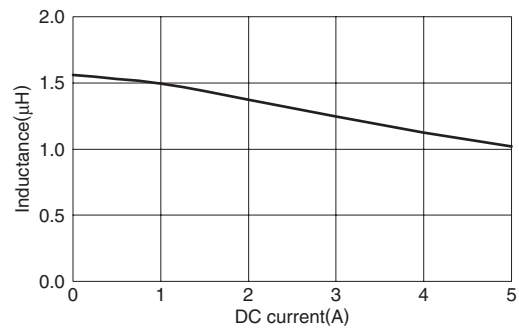

#### SPM3012T-2R2M

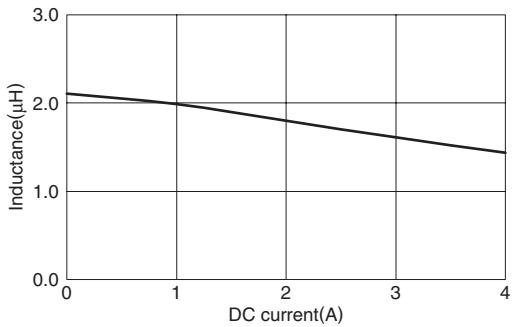

#### SPM3012T-3R3M

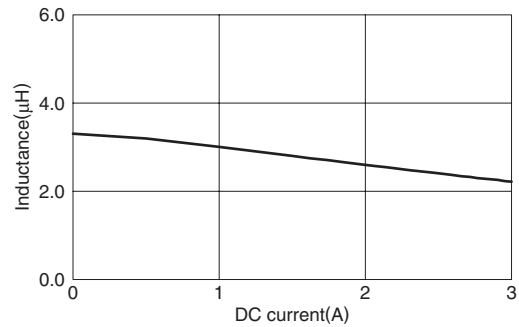

#### SPM3012T-4R7M

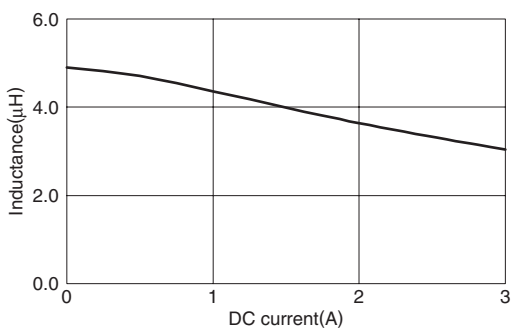

#### TEST CIRCUIT

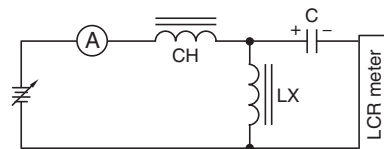

### PACKAGING STYLES

#### REEL DIMENSIONS

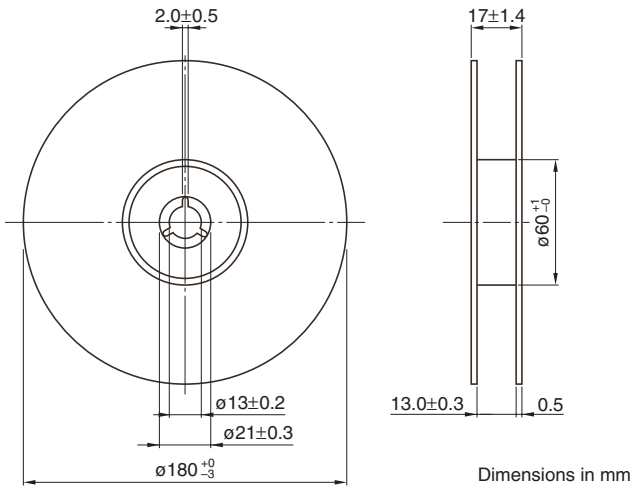

#### TAPE DIMENSIONS

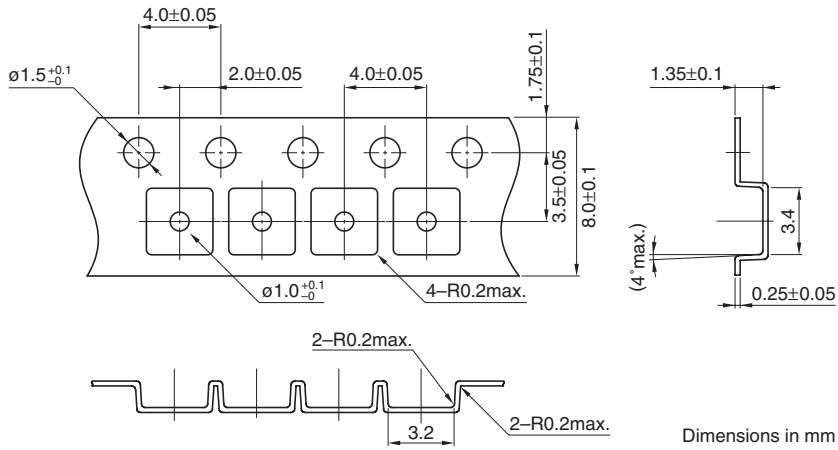

# Inductors for Power Circuits

## Wound/STD • Magnetic Shielded

Conformity to RoHS Directive

### SPM Series SPM5030

The SPM5030 contains SMD inductors for large currents. They have a high saturation current, and the DC superimposition characteristics have low temperature variance. This series can meet the needs of customers requiring products smaller than the SPM6530.

#### FEATURES

- Small and low profile design  
Size: 5.2×5.0mm  
Height: 3.0mm max.
- High power handling capability:  
Small copper loss  
Using large saturation induction of Fe-based metals
- Wide operating temperature range due to high Curie temperature of around 550°C.
- Available for automatic mounting in tape and reel package.

#### APPLICATIONS

Note book type computers, servers, VRMs, etc.

#### PRODUCT IDENTIFICATION

SPM	5030	T	-	□□□	-	□
(1)	(2)	(3)	(4)	(5)		

(1) Series name

(2) Dimensions L×H

5030 5.0×3.0mm max.

(3) Packaging style

T Embossed carrier tape

(4) Inductance value

R20 0.20μH

(5) Inductance tolerance

M ±20%

#### PACKAGING STYLE AND QUANTITIES

Packaging style	Quantity
Taping	500 pieces/reel

#### SHAPES AND DIMENSIONS

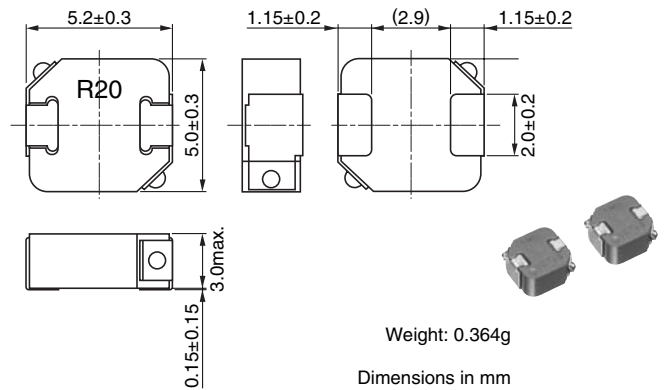

#### RECOMMENDED PC BOARD PATTERN

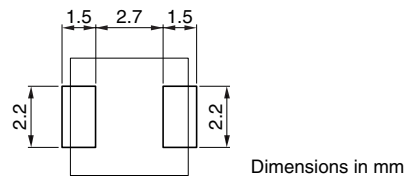

#### CIRCUIT DIAGRAM



#### RECOMMENDED SOLDERING CONDITION

##### REFLOW SOLDERING

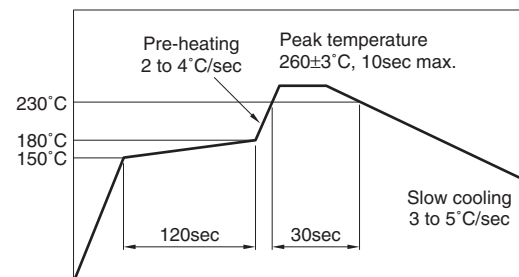

#### HANDLING AND PRECAUTIONS

- Please contact us before cleaning this product.
- Maintain a safe distance between this product and other components according to the working voltage.
- If this product is left in a humid environment for a long period of time, rust may appear on the surface. However, this does not affect performance.

• Conformity to RoHS Directive: This means that, in conformity with EU Directive 2002/95/EC, lead, cadmium, mercury, hexavalent chromium, and specific bromine-based flame retardants, PBB and PBDE, have not been used, except for exempted applications.

• Please contact our Sales office when your application is considered the following:  
The device's failure or malfunction may directly endanger human life (e.g. application for automobile/aircraft/medical/nuclear power devices, etc.)

• All specifications are subject to change without notice.

## ELECTRICAL CHARACTERISTICS

Part No.	Inductance ( $\mu\text{H}$ )	Tolerance (%)	Test frequency (kHz)	DC resistance(m $\Omega$ )		Rated current(A)*	
				max.	typ.	Based on inductance change typ.	Based on temperature rise typ.
SPM5030-R20M	0.20	$\pm 20$	100	2.31	2.1	21.0	22.2
SPM5030-R35M	0.35	$\pm 20$	100	4.29	3.9	14.9	16.6
SPM5030-R75M	0.75	$\pm 20$	100	9.35	8.5	9.7	11.3

\* Rated current: Value obtained when current flows and the temperature has risen to 40°C or when DC current flows and the nominal value of inductance has fallen by 20%, whichever is smaller.

- Operating temperature range: -40 to +125°C (Including self-temperature rise)

## TYPICAL ELECTRICAL CHARACTERISTICS

### INDUCTANCE CHANGE vs. DC SUPERPOSITION CHARACTERISTICS

#### SPM5030T-R20M

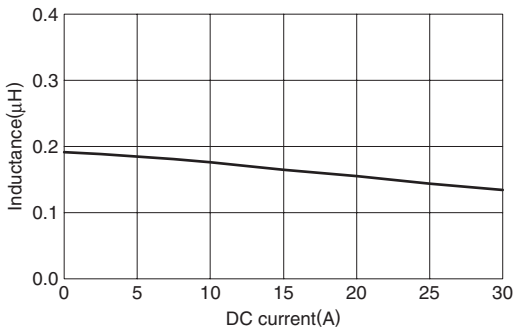

#### SPM5030T-R35M

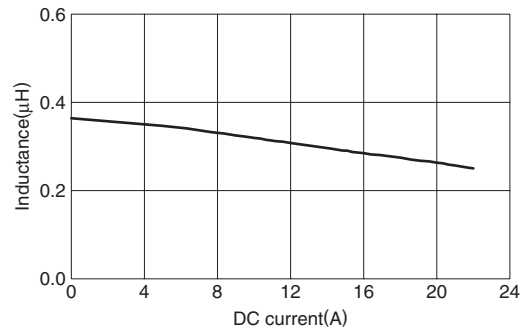

#### SPM5030T-R75M

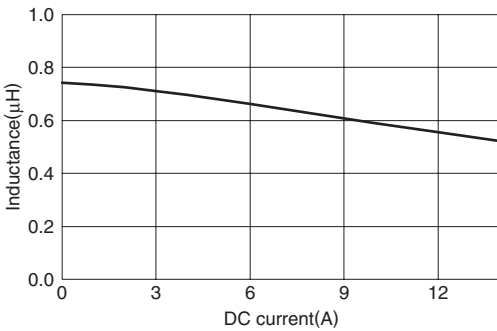

### TEST CIRCUIT

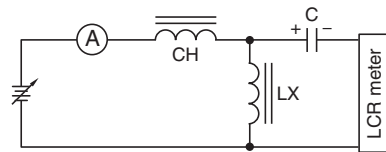

**PACKAGING STYLES**  
**REEL DIMENSIONS**

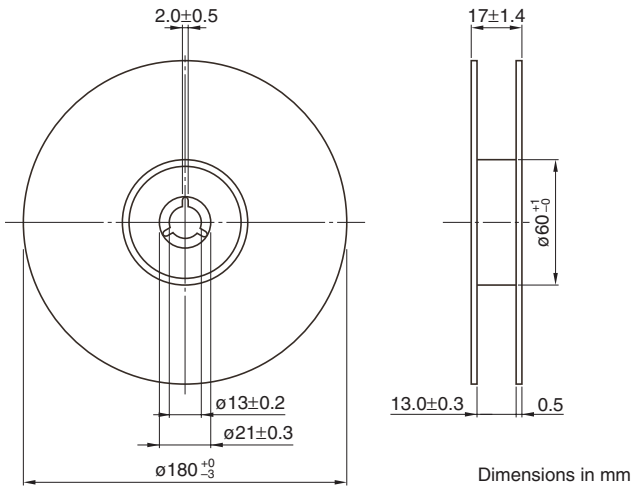

**TAPE DIMENSIONS**

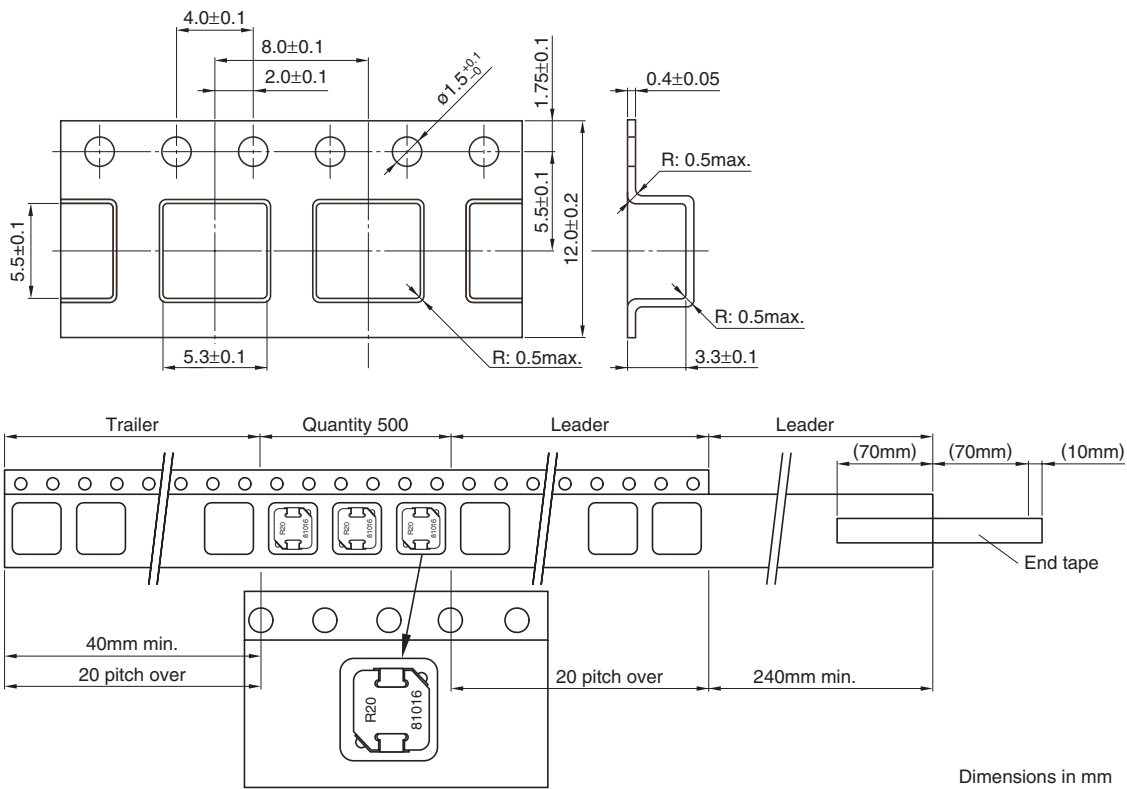

• All specifications are subject to change without notice.

# Inductors for Power Circuits

## Wound/STD • Magnetic Shielded

Conformity to RoHS Directive

### SPM Series SPM6530

The SPM6530 is a large-current SMD power inductor that uses a magnetic metal material.

This product has good superimposition characteristics and low DC resistance.

#### FEATURES

- Small footprint and Low profile design  
Footprint: 7.1×6.5mm  
Height: 3.0mm max.
- High power handling capability:  
Small copper loss  
Using large saturation induction of Fe-based metals
- A high Curie temperature of about 550°C means low inductance temperature variance.
- Available for automatic mounting in tape and reel package.

#### APPLICATIONS

Note book type computers, VRMs, etc.

#### PRODUCT IDENTIFICATION

SPM	6530	T	- 3R3	- M
(1)	(2)	(3)	(4)	(5)

(1) Series name

(2) Dimensions L×H

6530 6.5×3.0mm max.

(3) Packaging style

T Embossed carrier tape

(4) Inductance value

3R3 3.3μH

(5) Inductance tolerance

M ±20%

#### PACKAGING STYLE AND QUANTITIES

Packaging style	Quantity
Taping	1000 pieces/reel

#### SHAPES AND DIMENSIONS

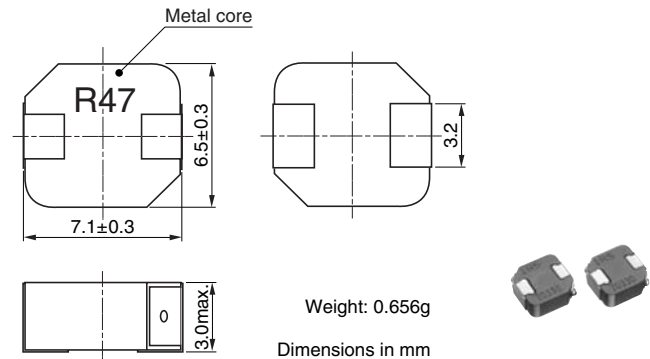

#### RECOMMENDED PC BOARD PATTERN

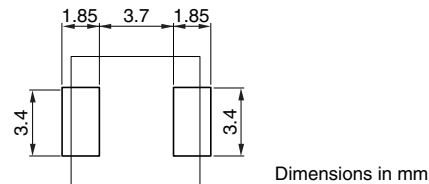

#### CIRCUIT DIAGRAM



#### RECOMMENDED SOLDERING CONDITION

##### REFLOW SOLDERING

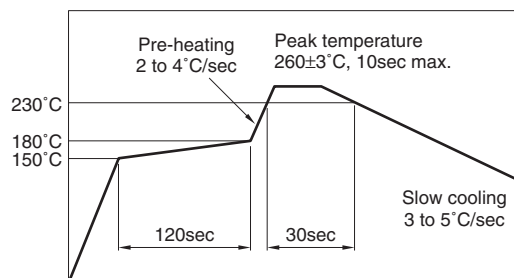

#### HANDLING AND PRECAUTIONS

- Please contact us before cleaning this product.
- Maintain a safe distance between this product and other components according to the working voltage.
- If this product is left in a humid environment for a long period of time, rust may appear on the surface. However, this does not affect performance.

• Conformity to RoHS Directive: This means that, in conformity with EU Directive 2002/95/EC, lead, cadmium, mercury, hexavalent chromium, and specific bromine-based flame retardants, PBB and PBDE, have not been used, except for exempted applications.

• Please contact our Sales office when your application is considered the following:

The device's failure or malfunction may directly endanger human life (e.g. application for automobile/aircraft/medical/nuclear power devices, etc.)

• All specifications are subject to change without notice.

## ELECTRICAL CHARACTERISTICS

Part No.	Inductance ( $\mu\text{H}$ )	Tolerance (%)	Test frequency (kHz)	DC resistance(m $\Omega$ )		Rated current(A)*	
				max.	typ.	Based on inductance change typ.	Based on temperature rise typ.
SPM6530T-R25M230	0.25	$\pm 20$	100	2.31	2.1	28.5	23
SPM6530T-R47M170	0.47	$\pm 20$	100	3.63	3.3	20.5	20
SPM6530T-R68M140	0.68	$\pm 20$	100	5.39	4.9	16.6	16
SPM6530T-1R0M120	1	$\pm 20$	100	7.81	7.1	14.1	13
SPM6530T-1R5M100	1.5	$\pm 20$	100	10.67	9.7	11.5	11
SPM6530T-2R2M	2.2	$\pm 20$	100	19	17.3	8.4	8.2
SPM6530T-3R3M	3.3	$\pm 20$	100	29.7	27	7.3	6.8
SPM6530T-4R7M	4.7	$\pm 20$	100	39.4	35.8	6.2	5.6

\* Rated current: Value obtained when current flows and the temperature has risen to 40°C or when DC current flows and the nominal value of inductance has fallen by 20%, whichever is smaller.

- Operating temperature range: -40 to +125°C (Including self-temperature rise)
- The cleaning agent can not be used for these parts.

### TYPICAL ELECTRICAL CHARACTERISTICS

#### INDUCTANCE CHANGE vs. DC SUPERPOSITION CHARACTERISTICS

##### SPM6530T-R25M230

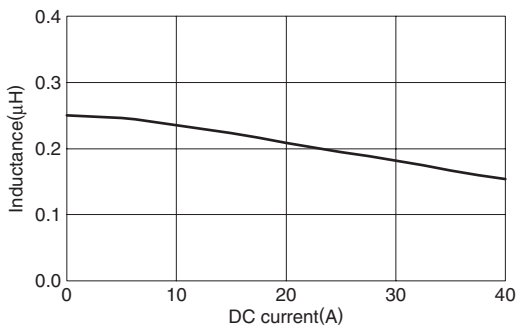

##### SPM6530T-R47M170

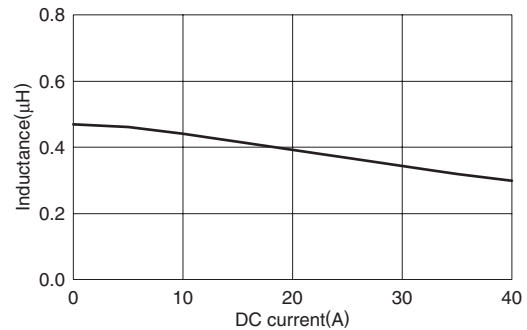

##### SPM6530T-R68M140

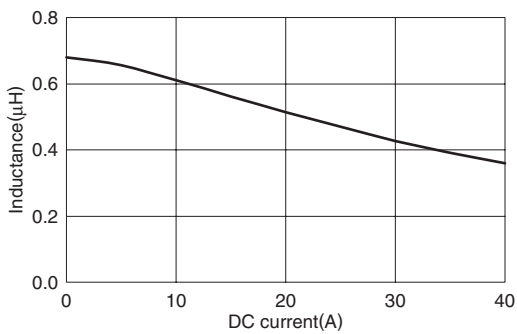

##### SPM6530T-1R0M120

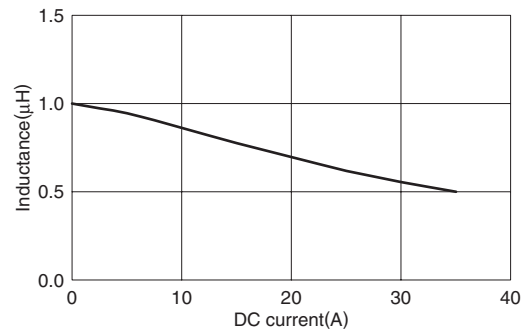

##### SPM6530T-1R5M100

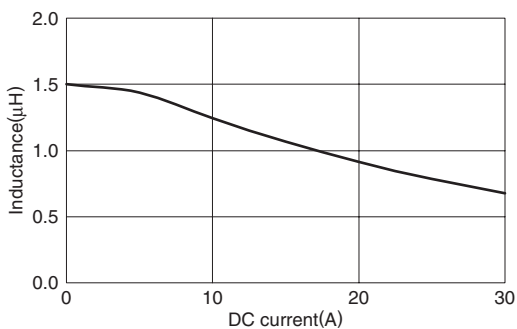

##### SPM6530T-2R2M

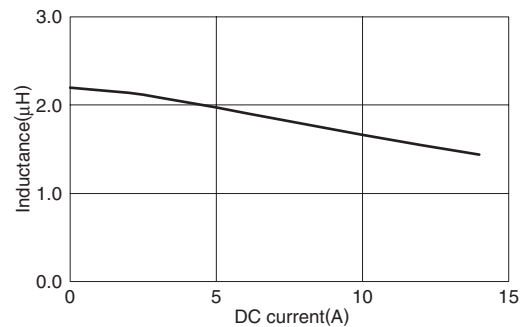

### TYPICAL ELECTRICAL CHARACTERISTICS

#### INDUCTANCE CHANGE vs. DC SUPERPOSITION CHARACTERISTICS

##### SPM6530T-3R3M

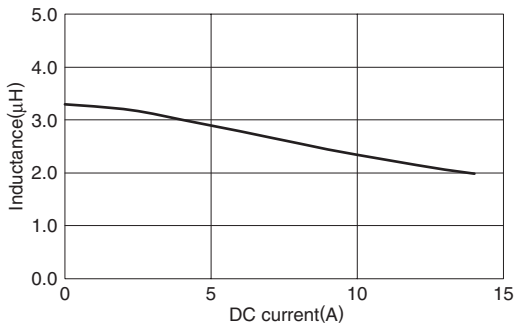

##### SPM6530T-4R7M

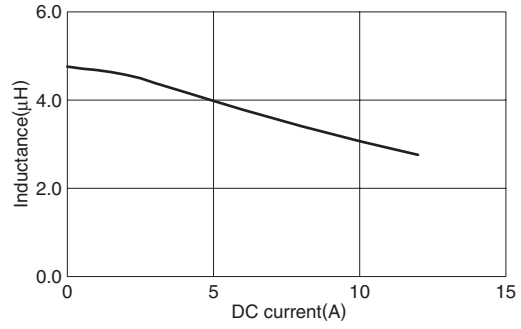

#### TEST CIRCUIT

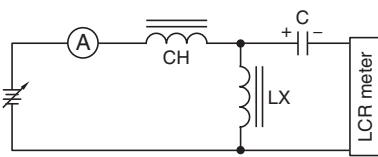

#### PACKAGING STYLES

##### REEL DIMENSIONS

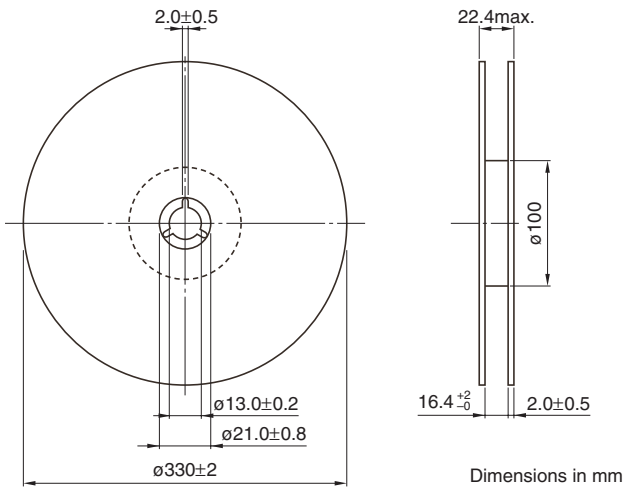

##### TAPE DIMENSIONS

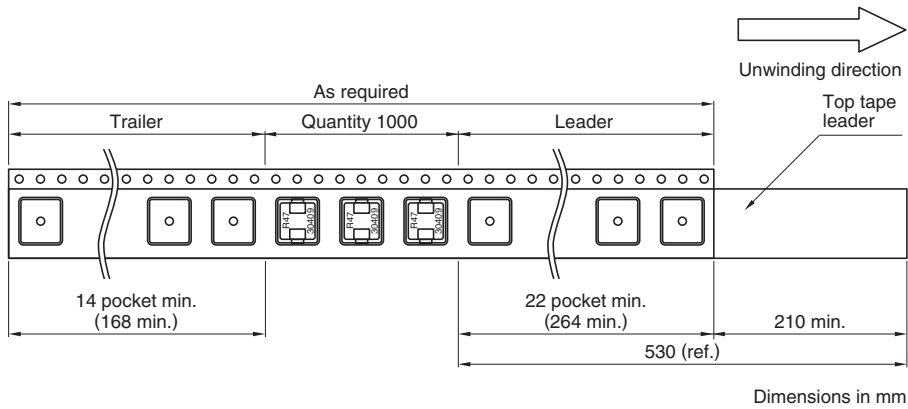

• All specifications are subject to change without notice.

Компания «Life Electronics» занимается поставками электронных компонентов импортного и отечественного производства от производителей и со складов крупных дистрибьюторов Европы, Америки и Азии.

С конца 2013 года компания активно расширяет линейку поставок компонентов по направлению коаксиальный кабель, кварцевые генераторы и конденсаторы (керамические, пленочные, электролитические), за счёт заключения дистрибьюторских договоров

Мы предлагаем:

- Конкуренспособные цены и скидки постоянным клиентам.
- Специальные условия для постоянных клиентов.
- Подбор аналогов.
- Поставку компонентов в любых объемах, удовлетворяющих вашим потребностям.
- Приемлемые сроки поставки, возможна ускоренная поставка.
- Доставку товара в любую точку России и стран СНГ.
- Комплексную поставку.
- Работу по проектам и поставку образцов.
- Формирование склада под заказчика.
- Сертификаты соответствия на поставляемую продукцию (по желанию клиента).
- Тестирование поставляемой продукции.
- Поставку компонентов, требующих военную и космическую приемку.
- Входной контроль качества.
- Наличие сертификата ISO.

В составе нашей компании организован Конструкторский отдел, призванный помогать разработчикам, и инженерам.

Конструкторский отдел помогает осуществить:

- Регистрацию проекта у производителя компонентов.
- Техническую поддержку проекта.
- Защиту от снятия компонента с производства.
- Оценку стоимости проекта по компонентам.
- Изготовление тестовой платы монтаж и пусконаладочные работы.



Тел: +7 (812) 336 43 04 (многоканальный)  
Email: org@lifeelectronics.ru