

### »» Features



- 10A general purpose Power Relay.
- Both available 0.25 and 0.187 terminals.
- SPDT, DPDT, TPDT contact configurations.
- AC & DC coils are both available.
- Optional for anti-rotation tab, tapped core, indicator lamp & push-to-test button, flanged cover.
- Comply with RoHS-Directive 2002/95/EC.

### »» Type List

#### ◆ 731

Terminal style	Contact form	Enclosure style				
		Open type	Dust cover	Ears on cover	Antirotation -tab	Ears on top
Quick terminal	1A (SPNO)	731-SPNO	731-SPNO-C	731-SPNO-C1	731-SPNO-C2	731-SPNO-C3
	1C (SPDT)	731-SPDT	731-SPDT-C	731-SPDT-C1	731-SPDT-C2	731-SPDT-C3
	2A (DPNO)	731-DPNO	731-DPNO-C	731-DPNO-C1	731-DPNO-C2	731-DPNO-C3
	2C (DPDT)	731-DPDT	731-DPDT-C	731-DPDT-C1	731-DPDT-C2	731-DPDT-C3
	3A (TPNO)	731-TPNO	731-TPNO-C	731-TPNO-C1	731-TPNO-C2	731-TPNO-C3
	3C (TPDT)	731-TPDT	731-TPDT-C	731-TPDT-C1	731-TPDT-C2	731-TPDT-C3

#### ◆ 731H

Terminal style	Contact form	Enclosure style		
		Dust cover	Ears on cover	Ears on top
Quick terminal	1A (SPNO)	731H-SPNO-C	731H-SPNO-C1	731H-SPNO-C3
	1C (SPDT)	731H-SPDT-C	731H-SPDT-C1	731H-SPDT-C3
	2A (DPNO)	731H-DPNO-C	731H-DPNO-C1	731H-DPNO-C3
	2C (DPDT)	731H-DPDT-C	731H-DPDT-C1	731H-DPDT-C3
	3A (TPNO)	731H-TPNO-C	731H-TPNO-C1	731H-TPNO-C3
	3C (TPDT)	731H-TPDT-C	731H-TPDT-C1	731H-TPDT-C3

### »» Ordering Information

731 □ - TPDT - □ □ - □  
 1 2 3 4 5 6

1. 731 -- Basic series designation
2. Blank -- Standard type  
H -- High power type
3. SPDT -- Single pole double throw  
SPNO -- Single pole normally open  
SPNC -- Single pole normally closed

- DPDT -- Double pole double throw
- DPNO -- Double pole normally open
- DPNC -- Double pole normally closed
- TPDT -- Three pole double throw
- TPNO -- Three pole normally open
- TPNC -- Three pole normally closed

4. Blank -- Open type without frame tab  
 C -- With cover  
 C1 -- With mounting ears on cover  
 C2 -- With accessible mounting hole with anti-rotation tab  
 C3 -- Mounting Ears on top of cover  
 X -- Open type with frame tab
5. Blank -- No special feature  
 M -- With manual operator  
 T -- Printed circuit board terminals  
 L -- Pilot lamp
6. Blank -- Standard type  
 F -- Class F

### »» Contact Rating

	731	731H 1P · 2P	731H 3P
Resistive load	10A 28VDC	20A 300VAC	16A 300VAC
	10A 240VAC	25A 277VAC	20A 277VAC

### »» Coil Rating (DC)

Rated voltage (V)	Rated current ±10 % at 23°C (mA)	Coil resistance ±10 % at 23°C (Ω)	Max. continuous voltage at 70°C	Pick up voltage(Max) at 23°C	Drop out voltage(Min) at 23°C	Power consumption at rated voltage
6	188	32	140 % of rated voltage	75 % of rated voltage	10 % of rated voltage	approx. 1.2W
12	100	120				
24	51	472				
48	27	1800				
110	11	10000				
120	12	10000				

### »» Coil Rating (AC)

Rated voltage (V)	Coil resistance ±10 % at 23°C (Ω)	Max. continuous voltage at 70°C	Pick up voltage(Max) at 23°C	Drop out voltage(Min) at 23°C	Power consumption at rated voltage	
SP DP	12	21	110 % of rated voltage	85 % of rated voltage	30 % of rated voltage	approx. 2.0VA
	24	85				
	110	1700				
	115	1700				
	120	2250				
	220	7200				
	230	7200				
	240	9110				

## »» Coil Rating (AC)

Rated voltage (V)	Coil resistance $\pm 10\%$ at 23°C ( $\Omega$ )	Max. continuous voltage at 70°C	Pick up voltage(Max) at 23°C	Drop out voltage(Min) at 23°C	Power consumption at rated voltage	
TP	12	18	110 % of rated voltage	85 % of rated voltage	30 % of rated voltage	approx. 2.7VA
	24	72				
	110	1300				
	115	1300				
	120	1700				
	220	5600				
	230	5600				
	240	7200				

## »» Specification

Contact material	AgSnO alloy	
Contact resistance <sup>(1)</sup>	50m $\Omega$ Max. (for 731) ; 100m $\Omega$ Max. (for 731H) (1A/6VDC by 4 pipes m $\Omega$ meter)	
Operate time <sup>(1)</sup>	20 ms Max.	
Release time <sup>(1)</sup>	20 ms Max.	
Insulation resistance <sup>(1)</sup>	1000 M $\Omega$ Min. (DC 500V)	
Dielectric strength <sup>(1)</sup>	Between open contact	: AC 500V , 50/60Hz 1 min. (for 731) : AC 1000V , 50/60Hz 1 min. (for 731H)
	Between contact and coil	: AC 1500V , 50/60Hz 1 min. (for 731) : AC 2500V , 50/60Hz 1 min. (for 731H)
	Between contact circuits	: AC 1500V , 50/60Hz 1 min. (for 731) : AC 2500V , 50/60Hz 1 min. (for 731H)
Vibration resistance	Operating extremes	10~55Hz , amplitude 1.0 mm
	Damage limits	10~55Hz , amplitude 1.5 mm
Shock resistance	Operating extremes	10G
	Damage limits	100G
Life expectancy	Mechanical	10,000,000 operations (frequency 18,000 ops./hr)
	Electrical	100,000 operations (frequency 1,200 ops./hr) (for 731) 50,000 operations (frequency 360 ops./hr) (for 731H)
Operating ambient temperature	-45~+70°C (no freezing) (for 731)	
	AC coil : -45~+55°C (no freezing) (for 731H) DC coil : -45~+65°C (no freezing)	
Weight	Approx. 79.2 g	

Note : (1) initial value.

# 731

## »» Safety Approval

Certified	731			731H
	UL	CSA	FIMKO	UL / CUL
File No.	E88991	1663800	23797	E88991

## »» Safety Approval Rating

731		731H 1P - 2P	731H 3P
UL - CSA	FIMKO	UL / CUL	
10A 240VAC	10A 250VAC	20A 300VAC	16A 300VAC
10A 28VDC		25A 277VAC	20A 277VAC
1/3HP 120VAC		1.5HP 240VAC	1.5HP 240VAC
1/2HP 240VAC		1HP 120VAC	1HP 120VAC

## »» Outline Dimensions

### ◆ 731 OPEN

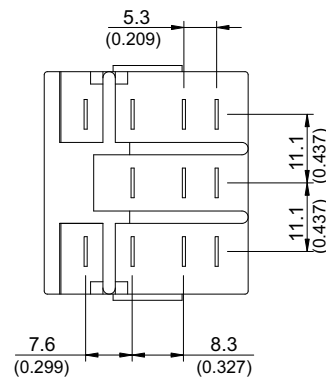
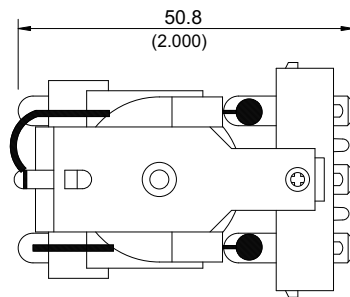
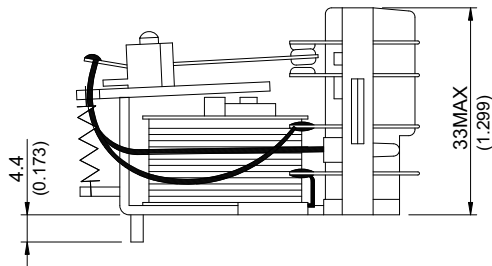

### ◆ 731 M

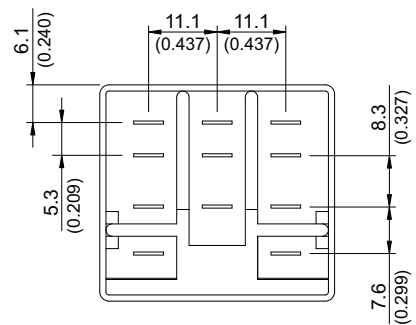
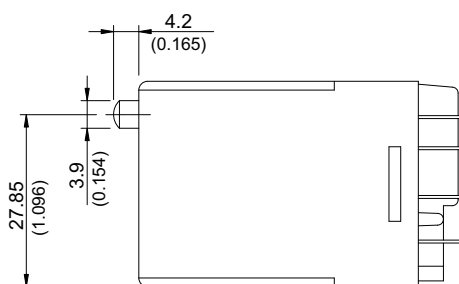

◆ 731 C

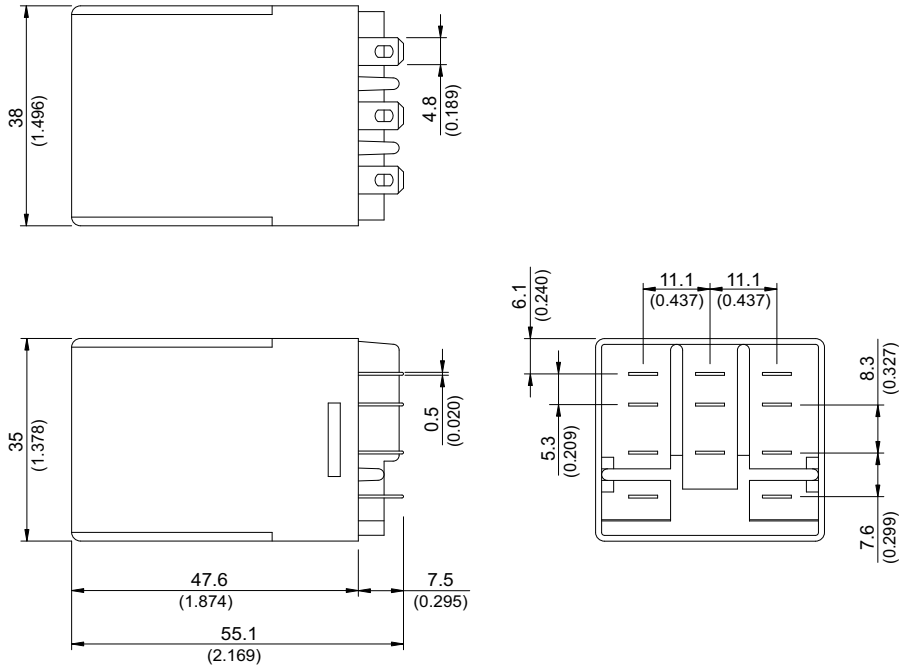

◆ 731 T

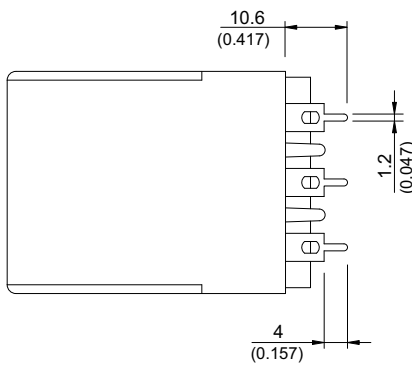

◆ 731 C2

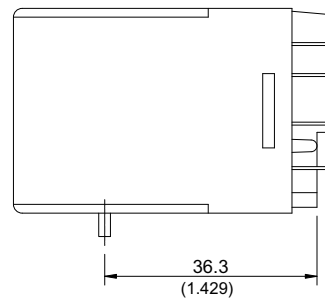

◆ 731 C1

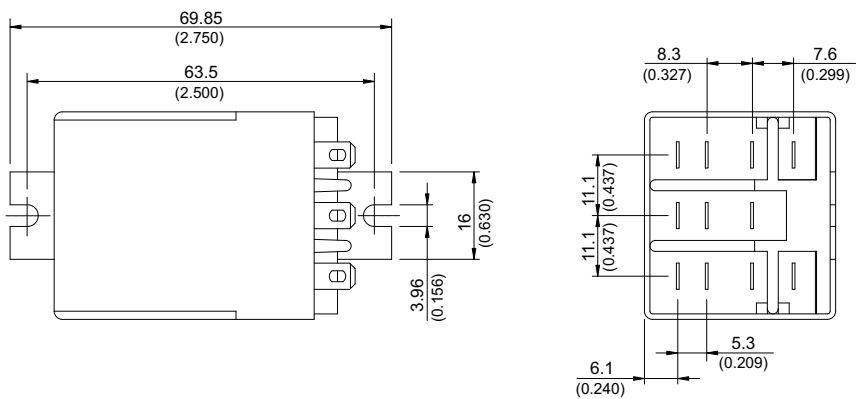

◆ 731 C3

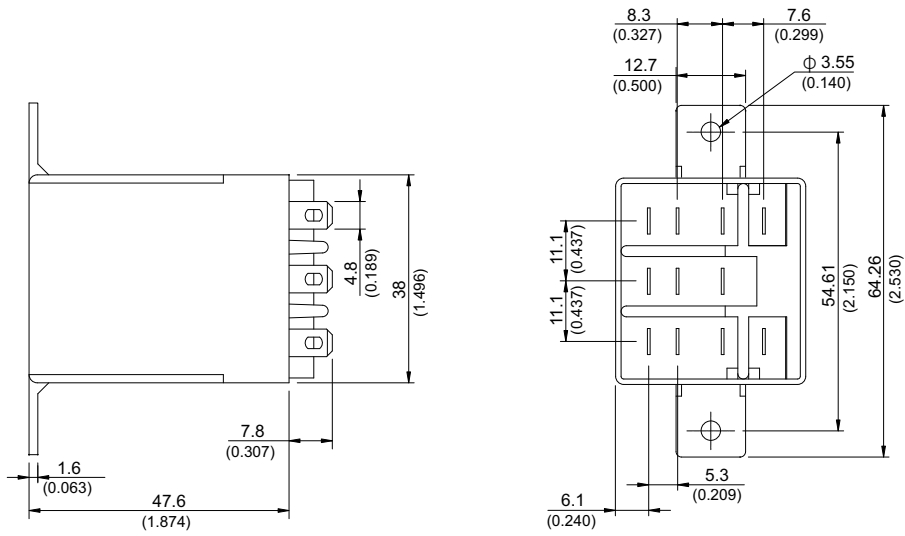

»» Wiring Diagram  
BOTTOM VIEW

SPNO

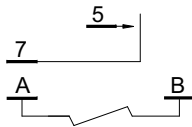

DPNO

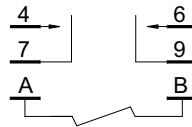

TPNO

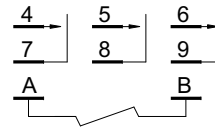

SPNC

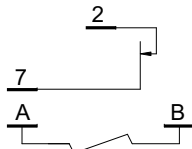

DPNC

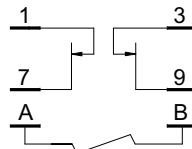

TPNC

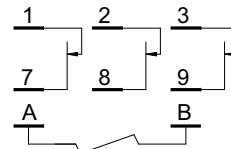

SPDT

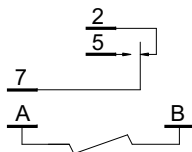

DPDT

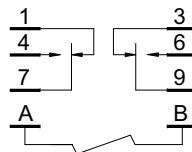

TPDT

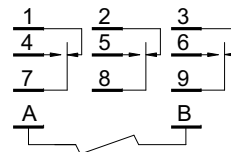

»» PC Board Layout  
BOTTOM VIEW

1P

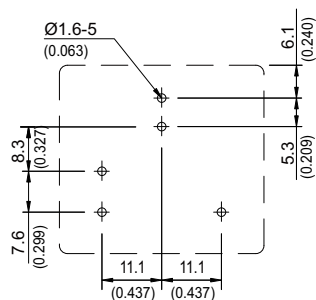

2P

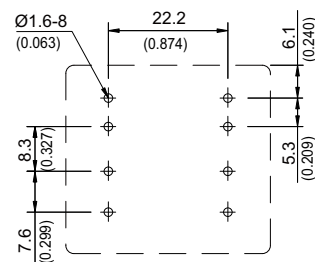

3P

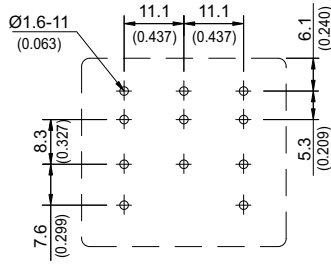

## » Engineering Data

◆ 731

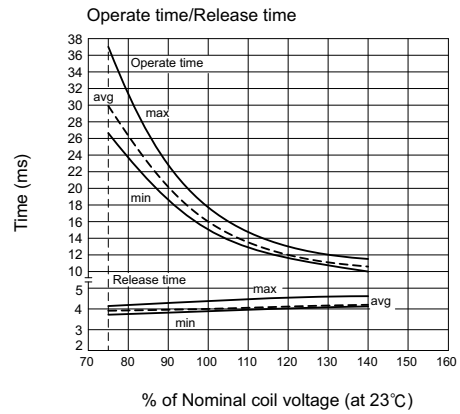
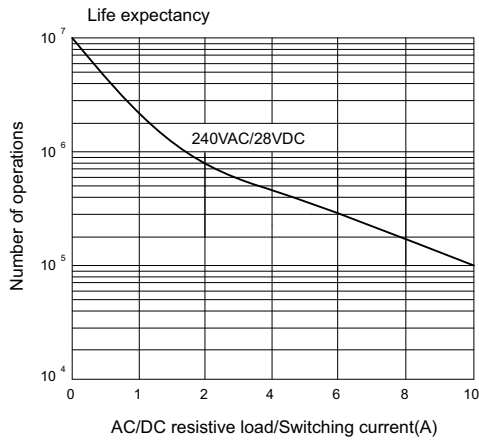
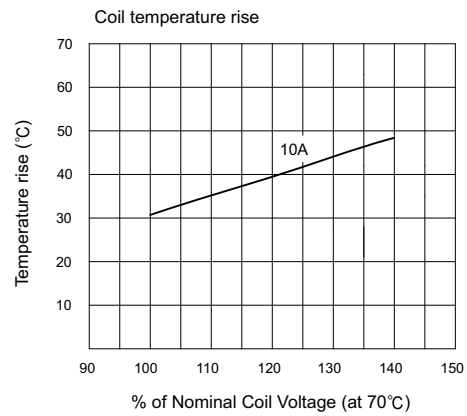
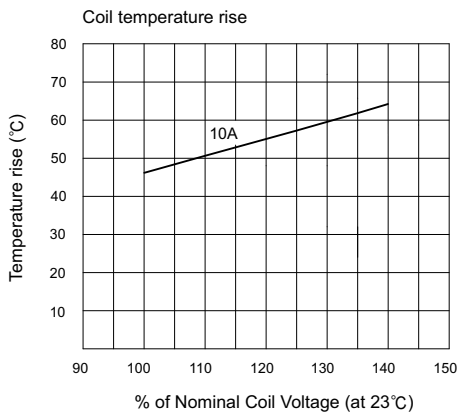

◆ 731 H

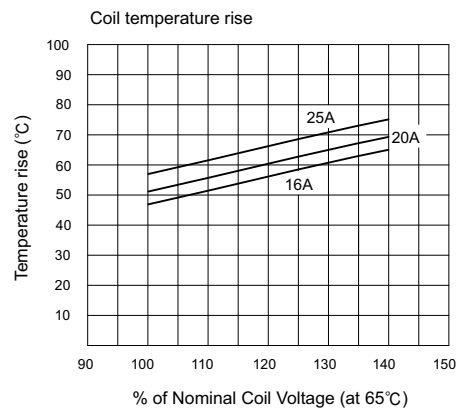
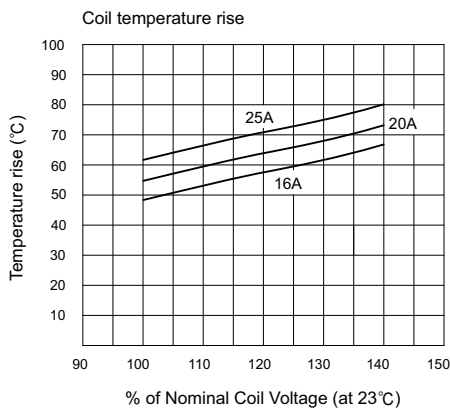

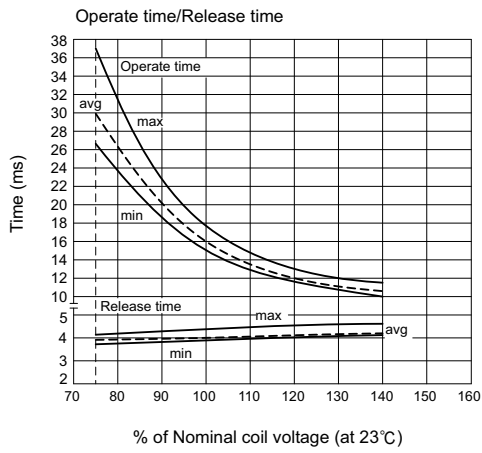
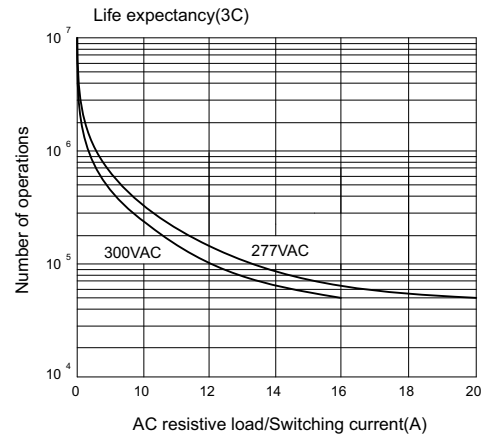
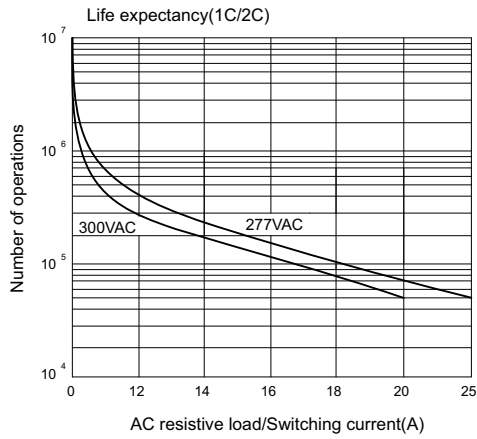

Компания «Life Electronics» занимается поставками электронных компонентов импортного и отечественного производства от производителей и со складов крупных дистрибьюторов Европы, Америки и Азии.

С конца 2013 года компания активно расширяет линейку поставок компонентов по направлению коаксиальный кабель, кварцевые генераторы и конденсаторы (керамические, пленочные, электролитические), за счёт заключения дистрибьюторских договоров

Мы предлагаем:

- Конкуренеспособные цены и скидки постоянным клиентам.
- Специальные условия для постоянных клиентов.
- Подбор аналогов.
- Поставку компонентов в любых объемах, удовлетворяющих вашим потребностям.
- Приемлемые сроки поставки, возможна ускоренная поставка.
- Доставку товара в любую точку России и стран СНГ.
- Комплексную поставку.
- Работу по проектам и поставку образцов.
- Формирование склада под заказчика.
- Сертификаты соответствия на поставляемую продукцию (по желанию клиента).
- Тестирование поставляемой продукции.
- Поставку компонентов, требующих военную и космическую приемку.
- Входной контроль качества.
- Наличие сертификата ISO.

В составе нашей компании организован Конструкторский отдел, призванный помогать разработчикам, и инженерам.

Конструкторский отдел помогает осуществить:

- Регистрацию проекта у производителя компонентов.
- Техническую поддержку проекта.
- Защиту от снятия компонента с производства.
- Оценку стоимости проекта по компонентам.
- Изготовление тестовой платы монтаж и пусконаладочные работы.



Тел: +7 (812) 336 43 04 (многоканальный)

Email: [org@lifeelectronics.ru](mailto:org@lifeelectronics.ru)