

Amphenol® MIL-DTL-5015 and MIL-5015 Type Standard Cylindrical Connectors

12-020-18



Amphenol

Table of Contents	Page
Introduction	2
Amphenol® MIL-DTL-5015 and MIL-5015 Type Standard Cylindrical Connectors	
General Information, Class Designations	3
MS-A, MS-C General Information	4
MS3100A or C wall mounting receptacle	5
MS3101A cable connecting plug	6
MS3102A or C box mounting receptacle	7
MS3106A straight plug	8
MS3108A 90 degree plug	9
MS-E/F General Information	10
MS3100E/F wall mounting receptacle	11
MS3101E/F cable connecting plug	12
MS3102E box mounting receptacle	13
MS3106E/F straight plug	14
MS3108E 90 degree plug	15
MS-R General Information	16
MS3100R wall mounting receptacle	17
MS3101R cable connecting plug	18
MS3102R box mounting receptacle	19
MS3106R straight plug	20
Contact and Insert Arrangements	21
MS/Standard insert arrangement charts	22, 23
MS/Standard special insert arrangement chart	24
MS/Standard alternate positioning	25
MS/Standard contact arrangements	26 – 37
MS/Standard special contact arrangements	38 – 48
MS/Standard thermocouple contact arrangements	49 – 53
MS/Standard Accessories	54
MS3057A cable clamp, MS3420 sleeve	55
10-305200 cable clamp, MS3420()A sleeve	56
10-350349 cable clamp, MS3420()A sleeve	57
10-74900 cable clamp	58
Thru-bulkhead shells	59, 60
Assembly instructions for 10-305200 and 10-74900 cable clamps	61
Grommet/sealing plugs	62
Plug protection caps	63
Receptacle protection caps	64
Dust caps	65
Sealing gaskets	66
Solder contacts	67
Crimp contacts	68
MS/Standard Application Tools	69
MS/Standard How to Order	70
Additional MS/Standard Connectors offered by Amphenol	
Matrix® MIL-DTL-5015 with crimp rear release contacts, MIL-5015 Type Modification Connectors, 97 Series (5015 type) Connectors, Pre-Earth FMLB Connectors	71
Amphe-Power® 5015 Connectors (AC threaded series with high amperage RADSOK® contacts), MIL-5015 Connectors with PCB contacts	72
Sales Office Listing	

This catalog covers Amphenol® MIL-DTL-5015 connectors and MIL-5015 type connectors. MIL-C-5015 has been replaced as follows:

Environmental Classes F and R are updated to and produced in strict accordance to MIL-DTL-5015.

Classes A, C and E are still produced, but are no longer listed on the qualified products listing (QPL).

Amphenol gives the user the largest selection of MS/Standard cylindrical connectors available in the market place.

This catalog is divided into three sections; the first section by service class, a second section by contacts and insert arrangements, and a third section for accessories. Each section is prefixed with an overview to assist the user in determining selections.

Should more information be required concerning the connectors covered in this publication, or if special application needs arise, please contact:

Amphenol Corporation
Amphenol Industrial Operations
40-60 Delaware Avenue
Sidney, New York 13838-1395
Telephone 607-563-5011
Fax: 607-563-5157
www.amphenol-industrial.com

Now, also offered within the broad family of Amphenol interconnection products is the Amphenol®/Matrix® MIL-DTL-5015* connector series which incorporates rear release crimp contacts. See page 71 for further description and for complete details ask for catalog 12-026.

Also ask for these additional product catalogs:

- Amphenol Industrial Connector Brochure, SL-381, for an overview of the industrial family of connectors.
- Amphenol Catalog SL-100, which provides an overview of all products, military and industrial, offered through Amphenol Aerospace.
- Amphenol Amphe-Power® Brochure SL-391, for AC 5015 type connectors with RADSOK® high amperage contacts. See reference on page 72.

* Note: MIL-C-5015 is superseded to MIL-DTL-5015 for all Amphenol/Matrix rear release crimp type connectors.

Amphenol Aerospace operates Quality Systems that are Certified to ISO-9001 and AS-9100 by third party Registrars.

Amphenol® MIL-DTL-5015 and MIL-5015 Type Standard Cylindrical Connectors



MS-A, MS-C



MS-E/F



MS-R

DESIGN CHARACTERISTICS

- Medium to heavy weight cylindrical
- Durable, field-proven design
- Environmental resistant
- Resilient inserts
- Operating voltage to 3000 VAC (RMS) at sea level
- Threaded couplings
- Single key/keyway shell polarization
- Cost effective

CUSTOMER OPTIONS

- Five shell styles
- Nineteen shell sizes
- 305 contact arrangements from 1 to 104 circuits
- Solder or crimp contacts, sizes 16-0 accepting 22-0 AWG.
- Coaxial and thermocouple contact options
- Five class designations
- Alternate insert positioning
- Hermetic configurations available
- Zinc alloy plating (cadmium-free) available

MS connectors meet the latest performance requirements of MIL-DTL-5015. These connectors represent well-proven electrical capability at an acceptable cost for most equipment where durability is important.

MIL-DTL-5015 features threaded couplings and single key/keyway polarization, representing maximum simplicity in design. Applications include military ground support equipment, ordnance and shipboard installations.

Amphenol Industrial Operations manufactures five classes of connectors to meet different requirements. Class designations and brief descriptions are listed below.

- A – Solid Shell – for general, non-environmental applications.
- C – Pressurized – for use on pressurized bulkheads or pressure barriers; limits air leakage regardless of type and class of plug mated with them.
- E/F – Environmental Resisting with Strain Relief – designed for applications where the connector will be exposed to moisture, vibration, and rapid changes in pressure and temperature.
- R – Lightweight Environmental Resisting – shorter in length and lighter in weight than the E and F classes, the MS-R offers a high degree of reliability under adverse conditions: recommended for new design applications.

MS/Standard MS-A and MS-C



wall mounting receptacle



cable connecting plug



box mounting receptacle



straight plug



90 degree plug

MS-A and MS-C

MS-A and MS-C class connectors perform many of the vital functions in powering, testing and ground support systems. Class A applications include communications equipment, computers and shipboard installations where mechanical forces and physical parameters are not subject to extreme or rapid environmental changes.

Class C connectors are most frequently used on pressurized bulkheads or pressure barriers at elevated altitudes or maritime applications. Air leakage is limited to one cubic inch per hour at a pressure differential of 30 lbs. per square inch.

Shells:

Shell components are fabricated from high grade aluminum alloy. Electrically conductive cadmium plate finish with an olive drab chromate after-treat offers corrosion resistance.

Contacts:

Contacts are available in both solder and crimp versions. Pins and sockets are machined from copper alloy with a silver plated finish. Size 16 and 12 socket contacts incorporate a closed entry design. Refer to pages 49, 67 and 68 for additional contact information.

Inserts:

Inserts are resilient neoprene, offering high dielectric strength, high arc resistance and resistance to vibration. Proprietary design permits pressurization of either pin or socket insert.

MS/Standard MS3100A or C wall mounting receptacle



To complete order number, see "how to order" pg. 70.
For solder well data, see page 67.

Shell Size	A Thread Class 2A	B Min Full Thread	K $+0.020$ -0.010	L ± 0.030	M $+0.010$ -0.000	R ± 0.005	S ± 0.031	T Dia. $+0.004$ -0.002	V Thread Class 2A	Z $+0.050$ -0.060
8S	.5000-28UNEF	.391	.672	1.391	.562	.594	.875	.120	.5000-28UNEF	.422
10S	.6250-24 UNF	.391	.672	1.468	.562	.719	1.000	.120	.5000-28UNEF	.422
10SL	.6250-24 UNF	.391	.672	1.468	.562	.719	1.000	.120	.6250-24NEF	.422
12S	.7500-20UNEF	.450	.672	1.468	.562	.812	1.094	.120	.6250-24NEF	.422
12	.7500-20UNEF	.625	.860	1.843	.750	.812	1.094	.120	.6250-24NEF	.672
14S	.8750-20UNEF	.450	.672	1.468	.562	.906	1.188	.120	.7500-20UNEF	.422
14	.8750-20UNEF	.625	.860	1.843	.750	.906	1.188	.120	.7500-20UNEF	.672
16S	1.0000-20UNEF	.450	.672	1.468	.562	.969	1.281	.120	.8750-20UNEF	.422
16	1.0000-20UNEF	.625	.860	1.843	.750	.969	1.281	.120	.8750-20UNEF	.672
18	1.1250-18NEF	.625	.891	1.938	.750	1.063	1.375	.120	1.0000-20UNEF	.641*
20	1.2500-18NEF	.625	.891	1.844	.750	1.156	1.500	.120	1.1875-18NEF	.641*
22	1.3750-18NEF	.625	.891	1.938	.750	1.250	1.625	.120	1.1875-18NEF	.641*
24	1.5000-18NEF	.625	.953	1.969	.812	1.375	1.750	.147	1.4375-18NEF	.578*
28	1.7500-18NS	.625	.953	2.188	.812	1.562	2.000	.147	1.4375-18NEF	.578*
32	2.0000-18NS	.625	1.031	2.157	.875	1.750	2.250	.173	1.7500-18NS	.500*
36	2.2500-16UN	.625	1.031	2.219	.875	1.938	2.500	.173	2.0000-18NS	.500*
40	2.5000-16UN	.625	1.031	2.188	.875	2.188	2.750	.173	2.2500-16UN	.500*
44***	2.7500-16UN	.625	1.031†	2.547	.875	2.375	3.000††	.173	2.5000-16UN	.751**
48***	3.0000-16UN	.625	1.031†	2.547	.875	2.625	3.000††	.173	3.0000-16UN	.751**

* Increase Z dimension by .312 for size "0" contact only.
** Increase Z dimension by .062 for size "0" contact only.
*** Available in proprietary version only.
† $+0.020$ -0.030
†† ± 0.020

MS/Standard MS3101A cable connecting plug



To complete order number, see "how to order" pg. 70.
For solder well data, see page 67.

Shell Size	A Thread Class 2A	B Min. Full Thread	L $\pm .030$	N Dia. Max.	V Thread Class 2A	Z $\pm .040$
8S	.5000-28UNEF	.406	1.390	.532	.5000-28UNEF	1.094
10S	.6250-24NEF	.406	1.468	.628	.5000-28UNEF	1.094
10SL	.6250-24NEF	.406	1.468	.755	.6250-24NEF	1.094
12S	.7500-20UNEF	.422	1.468	.755	.6250-24NEF	1.094
12	.7500-20UNEF	.656	1.843	.755	.6250-24NEF	1.532
14S	.8750-20UNEF	.391	1.468	.882	.7500-20UNEF	1.094
14	.8750-20UNEF	.625	1.843	.882	.7500-20UNEF	1.532
16S	1.0000-20UNEF	.391	1.468	1.010	.8750-20UNEF	1.094
16	1.0000-20UNEF	.625	1.843	1.010	.8750-20UNEF	1.532
18	1.1250-18NEF	.625	1.938	1.137	1.0000-20UNEF	1.532*
20	1.2500-18NEF	.625	1.844	1.264	1.1875-18NEF	1.532*
22	1.3750-18NEF	.625	1.938	1.392	1.1875-18NEF	1.532*
24	1.5000-18NEF	.625	1.969	1.519	1.4375-18NEF	1.532*
28	1.7500-18NS	.625	2.188	1.774	1.4375-18NEF	1.532*
32	2.0000-18NS	.625	2.157	1.996	1.7500-18NS	1.532*
36	2.2500-16UN	.625	2.219	2.251	2.0000-18NS	1.532*
40	2.5000-16UN	.625	2.188	2.506	2.2500-16UN	1.532*
44***	2.7500-16UN	.625	2.521	3.135	2.5000-16UN	1.782**

* Increase Z dimension by .312 for size "0" contact only.

** Increase Z dimension by .062 for size "0" contact only.

*** Available in proprietary version only.

MS/Standard MS3102A or C box mounting receptacle

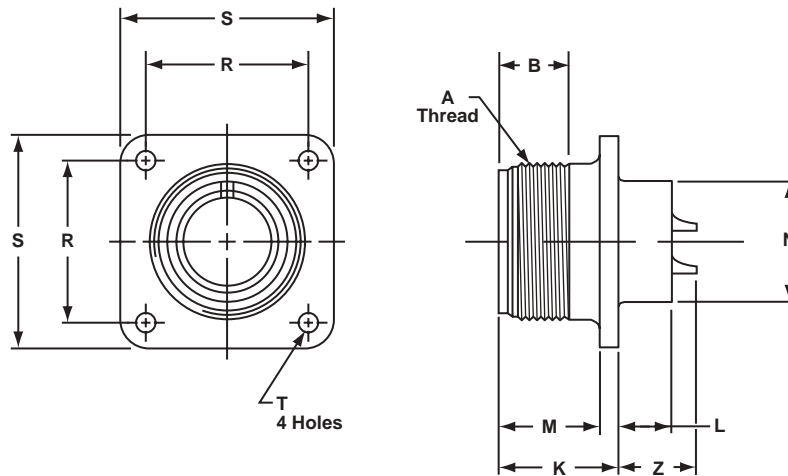

To complete order number, see "how to order" pg. 70.
For solder well data, see page 67.

Shell Size	A Thread Class 2A	B Min Full Thread	K +.020 - .010	L +.000 - .010	M +.010 - .000	N Dia. +.010 - .000	R ±.005	S ±.031	T Dia. +.004 - .002	Z +.050 - .060
8S	.5000-28UNEF	.391	.672	.297	.562	.375	.594	.875	.120	.422
10S	.6250-24NEF	.391	.672	.297	.562	.500	.719	1.000	.120	.422
10SL	.6250-24NEF	.391	.672	.297	.562	.625	.719	1.000	.120	.422
12S	.7500-20UNEF	.450	.672	.297	.562	.625	.812	1.094	.120	.422
12	.7500-20UNEF	.625	.860	.484	.750	.625	.812	1.094	.120	.672
14S	.8750-20UNEF	.450	.672	.297	.562	.750	.906	1.188	.120	.422
14	.8750-20UNEF	.625	.860	.484	.750	.750	.906	1.188	.120	.672
16S	1.0000-20UNEF	.450	.672	.297	.562	.875	.969	1.281	.120	.422
16	1.0000-20UNEF	.625	.860	.484	.750	.875	.969	1.281	.120	.672
18	1.1250-18NEF	.625	.891	.453	.750	1.000	1.062	1.375	.120	.641*
20	1.2500-18NEF	.625	.891	.453	.750	1.125	1.156	1.500	.120	.641*
22	1.3750-18NEF	.625	.891	.453	.750	1.250	1.250	1.625	.120	.641*
24	1.5000-18NEF	.625	.953	.453	.812	1.375	1.375	1.750	.147	.578
28	1.7500-18NS	.625	.953	.453	.812	1.625	1.562	2.000	.147	.578*
32	2.0000-18NS	.625	1.031	.438	.875	1.875	1.750	2.250	.173	.500*
36	2.2500-16UN	.625	1.031	.438	.875	2.062	1.938	2.500	.173	.500*
40	2.5000-16UN	.625	1.031	.438	.875	2.312	2.188	2.750	.173	.500*
44***	2.7500-16UN	.625	1.063	.543†	.875	2.594	2.375	3.000††	.173	.768**
48***	3.0000-16UN	.625	1.063	.543†	.875	2.812	2.625	3.250††	.209	.769**

* Increase Z dimension by .312 for size "0" contact only.
** Increase Z dimension by .062 for size "0" contact only.
*** Available in proprietary version only.
† +.020 -.030
†† ±.020

MS/Standard MS3106A straight plug



To complete order number, see "how to order" pg. 70.
For solder well data, see page 67.
All lockwire holes are .045 dia. min.

Shell Size	A Thread Class 2B	J ±.005	L ±.030	Q Dia. Max.	V Thread Class 2A	Z ±.045
8S	.5000-28UNEF	.531	.859	.741	.5000-28UNEF	.562
10S	.6250-24NEF	.531	.937	.869	.5000-28UNEF	.562
10SL	.6250-24NEF	.531	.937	.946	.6250-24NEF	.562
12S	.7500-20UNEF	.531	.937	.995	.6250-24NEF	.562
12	.7500-20UNEF	.719	1.124	.995	.6250-24NEF	.812
14S	.8750-20UNEF	.531	.937	1.123	.7500-20UNEF	.562
14	.8750-20UNEF	.719	1.124	1.123	.7500-20UNEF	.812
16S	1.0000-20UNEF	.531	.937	1.250	.8750-20UNEF	.562
16	1.0000-20UNEF	.719	1.124	1.250	.8750-20UNEF	.812
18	1.1250-18NEF	.719	1.219	1.333	1.0000-20UNEF	.812*
20	1.2500-18NEF	.719	1.125	1.461	1.1875-18NEF	.812*
22	1.3750-18NEF	.719	1.219	1.588	1.1875-18NEF	.812*
24	1.5000-18NEF	.719	1.251	1.715	1.4375-18NEF	.812*
28	1.7500-18NS	.719	1.470	1.968	1.4375-18NEF	.812*
32	2.0000-18NS	.719	1.439	2.209	1.7500-18NS	.812*
36	2.2500-16UN	.719	1.500	2.463	2.0000-18NS	.812*
40	2.5000-16UN	.719	1.469	2.719	2.2500-16UN	.812*
44***	2.7500-16UN	.719	1.818†	3.084	2.5000-16UN	1.063**
48***	3.3000-16UN	.719	1.818†	3.354	3.0000-16UN	1.063**

* Increase Z dimension by .312 for size "0" contact only.

** Increase Z dimension by .062 for size "0" contact only.

*** Available in proprietary version only.

† +.020 -.030

MS/Standard MS3108A 90 degree plug



To complete order number, see "how to order" pg. 70.
For solder well data, see page 67.
All lockwire holes are .045 dia. min.

Shell Size	A Thread Class 2B	J ±.005	L Max.	Q Dia. Max.	U Max.	V Thread Class 2A	W	Z ±.045
8S	.5000-28UNEF	.531	.896	.741	.750	.5000-28UNEF	.375	.562
10S	.6250-24NEF	.531	.927	.869	.750	.5000-28UNEF	.375	.562
10SL	.6250-24NEF	.531	.951	.946	.875	.6250-24NEF	.375	.562
12S	.7500-20UNEF	.531	.956	.995	.875	.6250-24NEF	.375	.562
12	.7500-20UNEF	.719	1.143	.995	.875	.6250-24NEF	.375	.812
14S	.8750-20UNEF	.531	1.120	1.123	1.000	.7500-20UNEF	.375	.562
14	.8750-20UNEF	.719	1.207	1.123	1.000	.7500-20UNEF	.375	.812
16S	1.0000-20UNEF	.531	1.146	1.250	1.062	.8750-20UNEF	.375	.562
16	1.0000-20UNEF	.719	1.332	1.250	1.062	.8750-20UNEF	.375	.812
18	1.1250-18NEF	.719	1.395	1.333	1.188	1.0000-20UNEF	.375	.812*
20	1.2500-18NEF	.719	1.645	1.461	1.250	1.1875-18NEF	.375	.812*
22	1.3750-18NEF	.719	1.645	1.588	1.312	1.1875-18NEF	.375	.812*
24	1.5000-18NEF	.719	1.896	1.715	1.438	1.4375-18NEF	.375	.812*
28	1.7500-18NS	.719	1.896	1.968	1.500	1.4375-18NEF	.375	.812*
32	2.0000-18NS	.719	2.118	2.209	1.750	1.7500-18NS	.438	.812*
36	2.2500-16UN	.719	2.176	2.463	1.875	2.0000-18NS	.500	.812*
40	2.5000-16UN	.719	2.301	2.719	2.031	2.2500-16UN	.500	.812*

* Increase Z dimension by .312 for size "0" contact only.

MS/Standard MS-E/F



wall mounting receptacle



cable connecting plug



box mounting receptacle



straight plug



90 degree plug

MS-E & F

MS Class F connectors satisfy all the performance requirements of MIL-DTL-5015. Class E, environmental is also produced, but is no longer listed on the qualified products listing (QPL). These connectors are recommended for conditions where vibration, moisture, pressure and/or temperature are extreme. Strain relief is supplied on most shell sizes.

Shells:

Shell components are fabricated from high grade aluminum alloy. The standard hardware plating is electrically conductive cadmium plated finish with an olive drab chromate after-treatment for corrosion resistance. Consult Amphenol, Sidney, NY for other plating options.

Contacts:

Contacts are silver plated copper alloy for maximum corrosion resistance, maximum current carrying capacity and low millivolt drop. Size 16 and 12 socket contacts incorporate a closed entry design. Crimp and solder versions are available. Refer to pages 49, 67 and 68 for additional contact information.

Inserts:

Resilient neoprene inserts provide an outstanding moisture barrier, high dielectric strength, and resistance to vibration. Either pin or socket insert can be pressurized.

Strain Relief Clamp:

Strain relief clamps minimize tension at the solder well connection and provide a positive mechanical moisture seal. Complete field serviceability is possible with the strain relief clamp.

MS/Standard MS3100E/F wall mounting receptacle



To complete order number, see "how to order" pg. 70.
For solder well data, see page 67.

Shell Size	A Thread Class 2A	B Min. Full Thread	K $+0.020$ -0.010	L Max.	M $+0.010$ -0.000	P Max.	R ± 0.005	S ± 0.010	T Dia. $+0.004$ -0.002	Z* Max.	XX Min. Cable Clearance
10SL	.6250-24UNEF	.391	.672	2.129	.562	.896	.719	1.000	.120	.472	.281
12S	.7500-20UNEF	.450	.672	2.129	.562	.896	.812	1.094	.120	.472	.281
12	.7500-20UNEF	.625	.860	2.129	.750	.896	.812	1.094	.120	.722	.281
14S	.8750-20UNEF	.450	.672	2.201	.562	1.021	.906	1.188	.120	.472	.406
14	.8750-20UNEF	.625	.860	2.524	.750	1.021	.906	1.188	.120	.722	.406
16S	1.0000-20UNEF	.450	.672	2.201	.562	1.151	.969	1.281	.120	.472	.500
16	1.0000-20UNEF	.625	.860	2.524	.750	1.151	.969	1.281	.120	.722	.500
18	1.1250-18UNEF	.625	.891	2.596	.750	1.242	1.063	1.375	.120	.691	.531
20	1.2500-18UNEF	.625	.891	2.654	.750	1.499	1.156	1.500	.120	.691	.656
22	1.3750-18UNEF	.625	.891	2.654	.750	1.499	1.250	1.625	.120	.691	.740
24	1.5000-18UNEF	.625	.953	2.885	.812	1.781	1.375	1.750	.147	.628	.781
28	1.7500-18UNS	.625	.953	2.885	.812	1.781	1.562	2.000	.147	.628	.922
32	2.0000-18UNS	.625	1.031	2.943	.875	2.087	1.750	2.250	.173	.550	1.156
36	2.2500-16UN	.625	1.031	2.943	.875	2.281	1.938	2.500	.173	.550	1.250
40	2.5000-16UN	.625	1.031	3.068	.875	2.581	2.188	2.750	.173	.550	1.562

* Increase Z dimension by .312 for size "0" contact only.

MS/Standard MS3101E/F cable connecting plug



To complete order number, see "how to order" pg. 70.
For solder well data, see page 67.

Shell Size	A Thread Class 2A	B Min. Full Thread	J Max.	L Max.	Z* Max.	XX Min. Cable Clearance
10SL	.6250-24UNEF	.406	.896	2.129	1.134	.281
12S	.7500-20UNEF	.422	.896	2.129	1.134	.281
12	.7500-20UNEF	.656	.896	2.129	1.572	.281
14S	.8750-20UNEF	.391	1.021	2.201	1.134	.406
14	.8750-20UNEF	.625	1.021	2.524	1.572	.406
16S	1.0000-20UNEF	.391	1.151	2.201	1.134	.500
16	1.0000-20UNEF	.625	1.151	2.524	1.572	.500
18	1.1250-18UNEF	.625	1.242	2.596	1.572	.531
20	1.2500-18UNEF	.625	1.499	2.654	1.572	.656
22	1.3750-18UNEF	.625	1.499	2.654	1.572	.740
24	1.5000-18UNEF	.625	1.781	2.885	1.572	.781
28	1.7500-18UNS	.625	1.781	2.885	1.572	.922
32	2.0000-18UNS	.625	2.087	2.943	1.572	1.156
36	2.2500-16UN	.625	2.281	2.943	1.572	1.250
40	2.5000-16UN	.625	2.581	3.068	1.572	1.562

* Increase Z dimension by .312 for size "0" contact only.

MS/Standard MS3102E box mounting receptacle



To complete order number, see "how to order" pg. 70.
For solder well data, see page 67.

Shell Size	A Thread Class 2A	B Min. Full Thread	K +.020 - .010	L +.000 - .010	M +.010 - .000	N Dia. +.010 - .000	R ±.005	S ±.031	T Dia. +.004 - .002	Z +.050 - .060
8S	.5000-28UNEF	.391	.672	.297	.562	.375	.594	.875	.120	.422
10S	.6250-24NEF	.391	.672	.297	.562	.500	.719	1.000	.120	.422
10SL	.6250-24NEF	.391	.672	.297	.562	.625	.719	1.000	.120	.422
12S	.7500-20UNEF	.450	.672	.297	.562	.625	.812	1.094	.120	.422
12	.7500-20UNEF	.625	.860	.484	.750	.625	.812	1.094	.120	.672
14S	.8750-20UNEF	.450	.672	.297	.562	.750	.906	1.188	.120	.422
14	.8750-20UNEF	.625	.860	.484	.750	.750	.906	1.188	.120	.672
16S	1.0000-20UNEF	.450	.672	.297	.562	.875	.969	1.281	.120	.422
16	1.0000-20UNEF	.625	.860	.484	.750	.875	.969	1.281	.120	.672
18	1.1250-18NEF	.625	.891	.453	.750	1.000	1.062	1.375	.120	.641*
20	1.2500-18NEF	.625	.891	.453	.750	1.125	1.156	1.500	.120	.641*
22	1.3750-18NEF	.625	.891	.453	.750	1.250	1.250	1.625	.120	.641*
24	1.5000-18NEF	.625	.953	.453	.812	1.375	1.375	1.750	.147	.578*
28	1.7500-18NS	.625	.953	.453	.812	1.625	1.562	2.000	.147	.578*
32	2.0000-18NS	.625	1.031	.438	.875	1.875	1.750	2.250	.173	.500*
36	2.2500-16UN	.625	1.031	.438	.875	2.062	1.938	2.500	.173	.500*
40	2.5000-16UN	.625	1.031	.438	.875	2.312	2.188	2.750	.173	.500*

* Increase Z dimension by .312 for size "0" contact only.

MS/Standard MS3106E/F straight plug



To complete order number, see "how to order" pg. 70.
For solder well data, see page 67.
All lockwire holes are .045 dia. min.

Shell Size	A Thread Class 2A	B ±.005	J Max.	L Max.	Q Max.	Z* ±.045	XX Min. Cable Clearance
10SL	.6250-24UNEF	.531	.896	2.129	.946	.607	.281
12S	.7500-20UNEF	.531	.896	2.129	.995	.607	.281
12	.7500-20UNEF	.719	.896	2.129	.995	.857	.281
14S	.8750-20UNEF	.531	1.021	2.201	1.123	.607	.406
14	.8750-20UNEF	.719	1.021	2.524	1.123	.857	.406
16S	1.0000-20UNEF	.531	1.151	2.201	1.250	.607	.500
16	1.0000-20UNEF	.719	1.151	2.524	1.250	.857	.500
18	1.1250-18UNEF	.719	1.242	2.596	1.333	.857	.531
20	1.2500-18UNEF	.719	1.499	2.654	1.461	.857	.656
22	1.3750-18UNEF	.719	1.499	2.654	1.588	.857	.740
24	1.5000-18UNEF	.719	1.781	2.885	1.715	.857	.781
28	1.7500-18UNS	.719	1.781	2.885	1.968	.857	.922
32	2.0000-18UNS	.719	2.087	2.943	2.209	.857	1.156
36	2.2500-16UN	.719	2.281	2.943	2.463	.857	1.250
40	2.5000-16UN	.719	2.581	3.068	2.718	.857	1.562

* Increase Z dimension by .312 for size "0" contact only.

MS/Standard MS3108E 90 degree plug



To complete order number, see "how to order" pg. 70.
For solder well data, see page 67.
All lockwire holes are .045 dia. min.

Shell Size	A Thread Class 2B	J ±.005	L Max.	N Max.	Q Dia. Max.	U Max.	Y Thread Class 2B	Z ±.045
8S	.5000-28UNEF	.531	.927	.807	.741	1.445	6-32NC	.562
10S	.6250-24NEF	.531	.927	.807	.869	1.445	6-32NC	.562
10SL	.6250-24NEF	.531	.951	.901	.946	1.508	6-32NC	.562
12S	.7500-20UNEF	.531	.956	.901	.995	1.508	6-32NC	.562
12	.7500-20UNEF	.719	1.143	.901	.995	1.508	6-32NC	.812
14S	.8750-20UNEF	.531	1.020	1.026	1.123	1.570	6-32NC	.562
14	.8750-20UNEF	.719	1.207	1.026	1.123	1.570	6-32NC	.812
16S	1.0000-20UNEF	.531	1.146	1.119	1.250	1.633	6-32NC	.562
16	1.1000-20UNEF	.719	1.333	1.119	1.250	1.633	6-32NC	.812
18	1.1250-18NEF	.719	1.395	1.229	1.333	1.759	6-32NC	.812*
20	1.2500-18NEF	.719	1.598	1.479	1.461	1.931	8-32NC	.812*
22	1.3750-18NEF	.719	1.598	1.479	1.588	1.993	8-32NC	.812*
24	1.5000-18NEF	.719	1.786	1.666	1.729	2.119	8-32NC	.812*
28	1.7500-18NS	.719	1.786	1.666	1.968	2.181	8-32NC	.812*
32	2.0000-18NS	.719	2.020	2.135	2.209	2.570	10-32NF	.812*
36	2.2500-16UN	.719	2.145	2.260	2.463	2.695	10-32NF	.812*
40	2.5000-16UN	.719	2.270	2.510	2.719	2.851	10-32NF	.812*

* Increase Z dimension by .312 for size "0" contact only.

MS/Standard MS-R



wall mounting receptacle



cable connecting plug



box mounting receptacle



straight plug

MS-R

Specification requirements for greater reliability in a shorter, lighter weight environmental resistant connector led to the design of the MS-R. MS Class R connectors satisfy all the performance requirements of MIL-DTL-5015.

This low profile assembly was attained by moving the axial compression nut and grommet assembly forward and flush with the rear of the insert. The neoprene grommet, with its low coefficient of friction, assures easier threading of wire bundles and quicker assembly and serviceability of the unit. Molded webs in each wire hole insure a moisture barrier around each wire.

The addition of an "O" ring at the main joint of all MS3106R plugs provide a main joint seal supplementary to the interfacial seal, thus insuring a higher degree of reliability when connector halves from different sources are employed. MS-R types are recommended for new design applications.

Shells:

Shell components are fabricated from high grade aluminum alloy. All components have the standard electrically conductive cadmium plated finish with an olive drab chromate after-treatment for corrosion resistance. Consult Amphenol, Sidney, NY for other plating options.

Contacts:

Contacts are machined from copper alloy for maximum corrosion resistance, maximum current carrying capacity and low millivolt drop. Both crimp and solder versions are available. Refer to pages 49, 67 and 68 for additional contact information.

Inserts:

Resilient neoprene inserts provide an outstanding moisture barrier, maximum vibration resistance and high dielectric strength. Either pin or socket insert can be pressurized.

MS/Standard MS3100R wall mounting receptacle

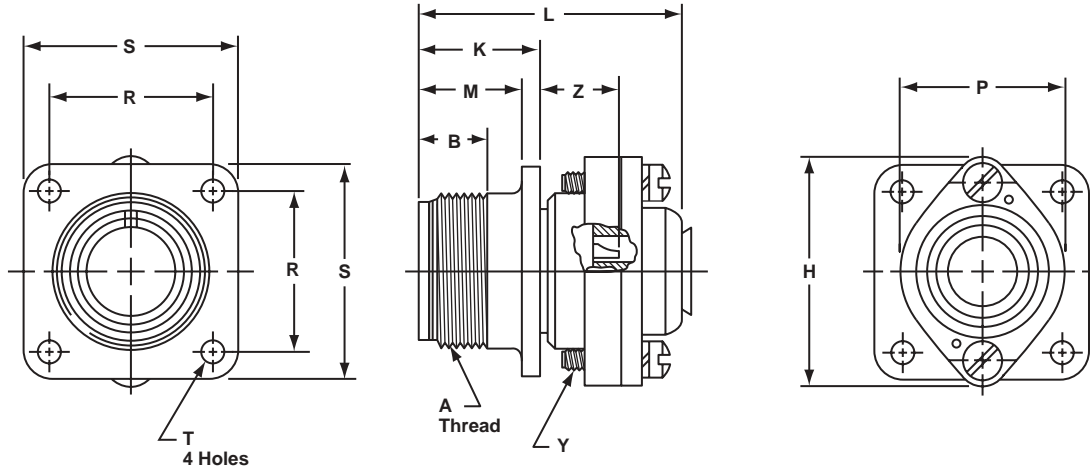

To complete order number, see "how to order" pg. 70.
For solder well data, see page 67.
All lockwire holes are .045 dia. min.

Shell Size	A Thread Class 2A	B Min. Full Thread	H Dia. Max.	K +.020 - .010	L Max.	M +.010 - .000	P Dia. Max.	R ±.005	S ±.031	Y Thread Class 2	T Dia. +.004 - .002	Z +.050 - .060
8S	.5000-28UNEF	.391	.959	.672	1.588	.562	.557	.594	.875	6-32NC	.120	.422
10S	.6250-24NEF	.391	1.026	.672	1.588	.562	.682	.719	1.000	6-32NC	.120	.422
10SL	.6250-24NEF	.391	1.120	.672	1.588	.562	.807	.719	1.000	6-32NC	.120	.422
12S	.7500-20UNEF	.450	1.120	.672	1.588	.562	.807	.812	1.094	6-32NC	.120	.422
12	.7500-20UNEF	.625	1.120	.860	1.931	.750	.807	.812	1.094	6-32NC	.120	.672
14S	.8750-20UNEF	.450	1.307	.672	1.588	.562	.932	.906	1.188	6-32NC	.120	.422
14	.8750-20UNEF	.625	1.307	.860	1.931	.750	.932	.906	1.188	6-32NC	.120	.672
16S	1.0000-20UNEF	.450	1.432	.672	1.588	.562	1.057	.969	1.281	6-32NC	.120	.422
16	1.0000-20UNEF	.625	1.432	.860	1.931	.750	1.057	.969	1.281	6-32NC	.120	.672
18	1.1250-18NEF	.625	1.557	.891	1.931	.750	1.182	1.063	1.375	6-32NC	.120	.641*
20	1.2500-18NEF	.625	1.744	.891	1.931	.750	1.291	1.156	1.500	8-32NC	.120	.641*
22	1.3750-18NEF	.625	1.869	.891	1.931	.750	1.432	1.250	1.625	8-32NC	.120	.641*
24	1.5000-18NEF	.625	1.994	.953	2.009	.812	1.557	1.375	1.750	8-32NC	.147	.578*
28	1.7500-18NS	.625	2.166	.953	2.009	.812	1.807	1.562	2.000	8-32NC	.147	.578*
32	2.0000-18NS	.625	2.541	1.031	2.072	.875	2.057	1.750	2.250	10-32NF	.173	.500*
36	2.2500-16UN	.625	2.729	1.031	2.072	.875	2.260	1.938	2.500	10-32NF	.173	.500*
40	2.5000-16UN	.625	2.979	1.031	2.072	.875	2.260	2.510	2.750	10-32NF	.173	.500*

* Increase Z dimension by .312 for size "0" contact only.

MS/Standard MS3101R cable connecting plug



To complete order number, see "how to order" pg. 70.
For solder well data, see page 67.
All lockwire holes are .045 dia. min.

Shell Size	A Thread Class 2A	B Min. Full Thread	F Dia. Max.	J Dia. Max.	L Max.	Y Thread Class 2	Z ±.040
8S	.5000-28UNEF	.406	.959	.557	1.588	6-32NC	1.094
10S	.6250-24NEF	.406	1.026	.682	1.588	6-32NC	1.094
10SL	.6250-24NEF	.406	1.120	.807	1.588	6-32NC	1.094
12S	.7500-20UNEF	.422	1.120	.807	1.588	6-32NC	1.094
12	.7500-20UNEF	.656	1.120	.807	1.931	6-32NC	1.532
14S	.8750-20UNEF	.391	1.307	.932	1.588	6-32NC	1.094
14	.8750-20UNEF	.625	1.307	.932	1.931	6-32NC	1.532
16S	1.0000-20UNEF	.391	1.432	1.057	1.588	6-32NC	1.094
16	1.0000-20UNEF	.625	1.432	1.057	1.931	6-32NC	1.532
18	1.1250-18NEF	.625	1.557	1.182	1.931	6-32NC	1.532*
20	1.2500-18NEF	.625	1.744	1.291	1.931	8-32NC	1.532*
22	1.3750-18NEF	.625	1.869	1.432	1.931	8-32NC	1.532*
24	1.5000-18NEF	.625	1.994	1.557	2.009	8-32NC	1.532*
28	1.7500-18NS	.625	2.166	1.807	2.009	8-32NC	1.532*
32	2.0000-18NS	.625	2.541	2.057	2.072	10-32NF	1.532*
36	2.2500-16UN	.625	2.729	2.260	2.072	10-32NF	1.532*
40	2.5000-16UN	.625	2.979	2.510	2.072	10-32NF	1.532*

* Increase Z dimension by .312 for size "0" contact only.

MS/Standard MS3102R box mounting receptacle

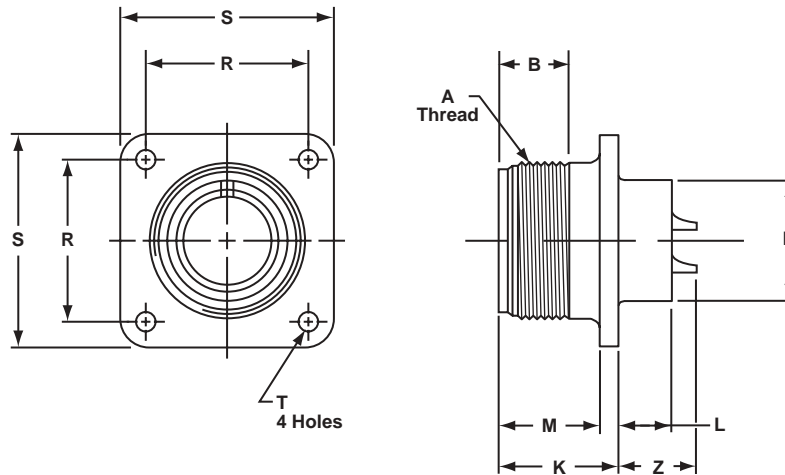

To complete order number, see "how to order" pg. 70.
For solder well data, see page 67.

Shell Size	A Thread Class 2A	B Min. Full Thread	K +.020 - .010	L +.000 - .010	M +.010 - .000	N Dia. +.010 - .000	R ±.005	S ±.031	T Dia. +.004 - .002	Z +.050 - .060
8S	.5000-28UNEF	.391	.672	.297	.562	.375	.594	.875	.120	.422
10S	.6250-24NEF	.391	.672	.297	.562	.500	.719	1.000	.120	.422
10SL	.6250-24NEF	.391	.672	.297	.562	.625	.719	1.000	.120	.422
12S	.7500-20UNEF	.450	.672	.297	.562	.625	.812	1.094	.120	.422
12	.7500-20UNEF	.625	.860	.484	.750	.625	.812	1.094	.120	.672
14S	.8750-20UNEF	.450	.672	.297	.562	.750	.906	1.188	.120	.422
14	.8750-20UNEF	.625	.860	.484	.750	.750	.906	1.188	.120	.672
16S	1.0000-20UNEF	.450	.672	.297	.562	.875	.969	1.281	.120	.422
16	1.0000-20UNEF	.625	.860	.484	.750	.875	.969	1.281	.120	.672
18	1.1250-18NEF	.625	.891	.453	.750	1.000	1.062	1.375	.120	.641*
20	1.2500-18NEF	.625	.891	.453	.750	1.125	1.156	1.500	.120	.641*
22	1.3750-18NEF	.625	.891	.453	.750	1.250	1.250	1.625	.120	.641*
24	1.5000-18NEF	.625	.953	.453	.812	1.375	1.375	1.750	.147	.578*
28	1.7500-18NS	.625	.953	.453	.812	1.625	1.562	2.000	.147	.578*
32	2.0000-18NS	.625	1.031	.438	.875	1.875	1.750	2.250	.173	.500*
36	2.2500-16UN	.625	1.031	.438	.875	2.062	1.938	2.500	.173	.500*
40	2.5000-16UN	.625	1.031	.438	.875	2.312	2.188	2.750	.173	.500*

* Increase Z dimension by .312 for size "0" contact only.

MS/Standard MS3106R straight plug



To complete order number, see "how to order" pg. 70.
For solder well data, see page 67.
All lockwire holes are .045 dia. min.

Shell Size	A Thread Class 2B	F Dia. Max.	J $\pm.005$	L Max.	N Dia. Max.	Q Dia. Max.	Y Thread Class 2	Z $\pm.045$
8S	.5000-28UNEF	.959	.531	1.057	.557	.741	6-32NC	.562
10S	.6250-24NEF	1.026	.531	1.057	.682	.869	6-32NC	.562
10SL	.6250-24NEF	1.120	.531	1.057	.807	.946	6-32NC	.562
12S	.7500-20UNEF	1.120	.531	1.057	.807	.995	6-32NC	.562
12	.7500-20UNEF	1.120	.719	1.212	.807	.995	6-32NC	.812
14S	.8750-20UNEF	1.307	.531	1.057	.932	1.123	6-32NC	.562
14	.8750-20UNEF	1.307	.719	1.212	.932	1.123	6-32NC	.812
16S	1.0000-20UNEF	1.432	.531	1.057	1.057	1.250	6-32NC	.562
16	1.0000-20UNEF	1.432	.719	1.212	1.057	1.250	6-32NC	.812
18	1.1250-18NEF	1.557	.719	1.212	1.182	1.333	6-32NC	.812*
20	1.2500-18NEF	1.744	.719	1.212	1.291	1.461	8-32NC	.812*
22	1.3750-18NEF	1.869	.719	1.212	1.432	1.588	8-32NC	.812*
24	1.5000-18NEF	1.994	.719	1.291	1.557	1.715	8-32NC	.812*
28	1.7500-18NS	2.166	.719	1.291	1.807	1.968	8-32NC	.812*
32	2.0000-18NS	2.541	.719	1.353	2.057	2.209	10-32NF	.812*
36	2.2500-16UN	2.729	.719	1.353	2.260	2.463	10-32NF	.812*
40	2.5000-16UN	2.979	.719	1.353	2.510	2.719	10-32NF	.812*

* Increase Z dimension by .312 for size "0" contact only.

MS/Standard
contact and
insert arrangements

MS/Standard insert arrangements

Insert Arrangement	Service Rating	Total Contacts	Contact Size				
			0	4	8	12	16
8S-1	A	1					1
10S-2	A	1					1
10SL-3	A	3					3
10SL-4†	A	2					2
12S-3	A	2					2
12S-4	D	1					1
12-5	D	1				1	
14S-1	A	3					3
14S-2	Inst.	4					4
14S-4	D	1					1
14S-5	Inst.	5					5
14S-6	Inst.	6					6
14S-7	A	3					3
14S-9	A	2					2
14S-10	Inst.	4					4
14S-12	A	3					3
14-3	A	1			1		
16S-1	A	7					7
16S-3	B	1					1
16S-4	D	2					2
16S-5	A	3					3
16S-6	A	3					3
16S-8	A	5					5
16-2	E	1				1	
16-7	A	3			1		2
16-9	A	4				2	2
16-10	A	3				3	
16-11	A	2				2	
16-12	A	1		1			
16-13	A	2				2	
18-1	A/Inst.	10					10
18-3	D	2				2	
18-4	D	4					4
18-5	D	3				2	1
18-6	D	1		1			
18-7	B	1			1		
18-8	A	8				1	7
18-9	Inst.	7				2	5
18-10	A	4				4	
18-11	A	5				5	
18-12	A	6					6
18-13	A	4			1	3	
18-14	A	2		1			1
18-15	A	4				4	
18-16	C	1				1	
18-17	Inst.	7				2	5
18-19	A	10					10
18-20	A	5					5
18-22	D	3					3
18-24	A/Inst.	10					10
18-29	A	5					5
18-30	A	5					5

Insert Arrangement	Service Rating	Total Contacts	Contact Size				
			0	4	8	12	16
18-31	A	5					5
20-2	D	1	1				
20-3	D	3				3	
20-4	D	4				4	
20-6	D	3					3
20-7	D/A	8					8
20-8	Inst.	6			2		4
20-9	D/A	8				1	7
20-11	Inst.	13					13
20-12	A	2		1			1
20-14	A	5			2	3	
20-15	A	7				7	
20-16	A	9				2	7
20-17	A	6				5	1
20-18	A	9				3	6
20-19	A	3			3		
20-20	A	4		1		3	
20-21	A	9				1	8
20-22	A	6			3		3
20-23	A	2			2		
20-24	A	4			2		2
20-25	Inst.	13					13
20-27	A	14					14
20-29	A	17					17
20-30	Inst.	13					13
20-33	A	11					11
22-1	D	2			2		
22-2	D	3			3		
22-4	A	4			2	2	
22-5	D	6				2	4
22-6	D	3			2		1
22-7	E	1	1				
22-8	E	2				2	
22-9	E	3				3	
22-10	E	4					4
22-11	B	2					2
22-12	D	5			2		3
22-13	D/A	5				4	1
22-14	A	19					19
22-15	E/A	6				5	1
22-16	A	9				3	6
22-17	D/A	9				1	8
22-18	D/A	8					8
22-19	A	14					14
22-20	A	9					9
22-21	A	3	1				2
22-22	A	4			4		
22-23	D/A	8				8	
22-24	D/A	6				2	4
22-27	D/A	9			1		8
22-28	A	7				7	

† 10SL-4 arrangement available only with pin contacts in receptacle and socket contacts in plug

MS/Standard

insert arrangements, cont.

Insert Arrangement	Service Rating	Total Contacts	Contact Size				
			0	4	8	12	16
22-33	D/A	7					7
22-34	D	5				3	2
22-36	D/A	8				8	
24-2	D	7				7	
24-3	D	7				2	5
24-5	A	16					16
24-6	D/A	8				8	
24-7	A	16				2	14
24-9	A	2		2			
24-10	A	7			7		
24-11	A	9			3	6	
24-12	A	5		2		3	
24-16	D/A	7			1	3	3
24-17	D	5				2	3
24-20	D	11				2	9
24-21	D	10			1		9
24-22	D	4			4		
24-27	E	7					7
24-28	Inst.	24					24
28-1	D/A	9			3	6	
28-2	D	14				2	12
28-3	E	3			3		
28-4	E/D	9				2	7
28-5	D	5		2		1	2
28-6	D	3		3			
28-7	D	2		2			
28-8	E/D/A	12				2	10
28-9	D	12				6	6
28-10	D/A	7		2	2	3	
28-11	A	22				4	18
28-12	A	26					26
28-13	A	26					26
28-15	A	35					35
28-16	A	20					20
28-17	B/D/A	15					15
28-18	C/D/A/Inst.	12					12
28-19	B/D/A	10				4	6
28-20	A	14				10	4
28-21	A	37					37
28-22	D	6		3			3

Insert Arrangement	Service Rating	Total Contacts	Contact Size				
			0	4	8	12	16
32-1	E/D	5	2			3	
32-2	E	5		3			2
32-3	D	9	1	2		2	4
32-4	A/D	14				2	12
32-5	D	2	2				
32-6	A	23		2	3	2	16
32-7	Inst./A	35				7	28
32-8	A	30				6	24
32-9	D	14		2			12
32-10	E/B/D/A	7		2	2		3
32-12	A/D	15				5	10
32-13	D	23				5	18
32-15	D	8	2			6	
32-16	A	23		2	3	2	16
32-17	D	4		4			
32-22	A	54					54
36-1	D	22				4	18
36-3	D	6	3			3	
36-4	D/A	3	3				
36-5	A	4	4				
36-6	A	6	2	4			
36-7	A	47				7	40
36-8	A	47				1	46
36-9	A	31		1	2	14	14
36-10	A	48					48
36-11	A	48					48
36-12	A	48					48
36-13	E/A	17				2	15
36-14	D	16			5	5	6
36-15	D/A	35					35
36-16	A	47				7	40
36-17	A	47				7	40
36-18	A	31		1	2	14	14
36-20	A	34			2	2	30
36-52	A	52					52
40-1	D	30				6	24
40-9	A	47			1	22	24
40-56	A	85					85
48-62	D	85					85

MS/Standard insert alternate positioning

To avoid cross-plugging problems in applications requiring the use of more than one connector of the same size and arrangement, alternate rotations are available as indicated in the accompanying charts.

As shown in the diagram below, the front face of the pin insert is rotated within the shell in a clockwise direction from the normal shell key. The socket insert would be rotated counter-clockwise the same number of degrees in respect to the normal shell key.



The following insert arrangements have the same alternate insert rotations for W, X, Y and Z, which are:

Degrees			
W	X	Y	Z
80	110	250	280

16-7	20-22	22-29	24-17	28-16	32-13
18-5	22-6	22-33	24-20	28-17	32-22
18-9	22-12	22-34	24-21	28-19	32-AF
18-13	22-14	24-1	24-28	28-20	36-1
18-14	22-15	24-3	28-1	28-21	36-7
20-7	22-16	24-4	28-4	32-1	36-8
20-8	22-17	24-5	28-8	32-3	36-13
20-9	22-18	24-6	28-9	32-4	40-AR
20-12	22-19	24-7	28-10	32-6	40-AS
20-14	22-21	24-12	28-11	32-9	40-AT
20-16	22-24	24-14	28-14	32-10	40-AU
20-20	22-25	24-16	28-15	32-12	







Insert Arrangement	Degrees			
	W	X	Y	Z
10SL-4	63	-	-	-
12S-3	70	145	215	290
14S-2	-	120	240	-
14S-5	-	110	-	-
14S-7	90	180	270	-
14S-9	70	145	215	290
16-9	35	110	250	325
16-10	90	180	270	-
16-11	35	110	250	325
16-13	35	110	250	325
16S-1	80	-	-	280
16S-4	35	110	250	325
16S-5	70	145	215	290
16S-6	90	180	270	-
16S-8	-	170	265	-
18-1	70	145	215	290
18-3	35	110	250	325
18-4	35	110	250	325
18-8	70	-	-	290
18-10	-	120	240	-
18-11	-	170	265	-
18-12	80	-	-	280
18-15	-	120	240	-
18-20	90	180	270	-
18-22	70	145	215	290
18-29	90	180	270	-
20-3	70	145	215	290
20-4	45	110	250	-
20-5	35	110	250	325
20-6	70	145	215	290
20-15	80	-	-	280
20-17	90	180	270	-
20-18	35	110	250	325
20-19	90	180	270	-
20-21	35	110	250	325







Insert Arrangement	Degrees			
	W	X	Y	Z
20-23	35	110	250	325
20-24	35	110	250	325
20-27	35	110	250	325
20-29	80	-	-	280
22-1	35	110	250	325
22-2	70	145	215	290
22-4	35	110	250	325
22-5	35	110	250	325
22-8	35	110	250	325
22-9	70	145	215	290
22-10	35	110	250	325
22-11	35	110	250	325
22-13	35	110	250	325
22-20	35	110	250	325
22-22	-	110	250	-
22-23	35	-	250	-
22-27	80	-	250	280
22-28	80	-	-	280
22-63	20	-	-	-
24-2	80	-	-	280
24-9	35	110	250	325
24-10	80	-	-	280
24-11	35	110	250	325
24-22	45	110	250	-
24-27	80	-	-	280
28-2	35	110	250	325
28-3	70	145	215	290
28-5	35	110	250	325
28-6	70	145	215	290
28-7	35	110	250	325
28-12	90	180	270	-
28-18	70	145	215	290
28-22	70	145	215	290
28-AY	45	110	250	-
32-2	70	145	215	290







Insert Arrangement	Degrees			
	W	X	Y	Z
32-5	35	110	250	325
32-7	80	125	235	280
32-8	80	125	235	280
32-14	65	130	230	295
32-15	35	110	250	280
32-17	45	110	250	-
32-25	60	120	-	-
32-48	80	-	-	-
32-64	80	100	110	250
32-68	30	-	-	-
32-82	30	-	-	-
36-3	70	145	215	290
36-4	70	145	215	290
36-5	-	120	240	-
36-6	35	110	250	325
36-9	80	125	235	280
36-10	80	125	235	280
36-14	90	180	270	-
36-15	60	125	245	305
36-AF	65	-	-	-
40-1	65	130	235	300
40-5	33	-	-	270
40-9	65	125	225	310
40-10	65	125	225	310
40-35	70	130	230	290
40-AD	45	-	-	-
40-AG	37	74	285	322
40-AP	35	110	250	325
40-AV	90	180	270	-







MS/Standard contact arrangements

front face of pin insert or rear face of socket insert illustrated

							
			Front of Socket Insert	Front of Socket Insert			
Insert Arrangement	8S-1	10S-2	10SL-3	10SL-4	12S-3	12S-4	12-5
Service Rating	A	A	A	A	A	D	D
Number of Contacts	1	1	3	2	2	1	1
Contact Size	16	16	16	16	16	16	12

							
Insert Arrangement	14S-1	14S-2	14S-4	14S-5	14S-6	14S-7	14S-9
Service Rating	A	Inst.	D	Inst.	Inst.	A	A
Number of Contacts	3	4	1	5	6	3	2
Contact Size	16	16	16	16	16	16	16

						
	100° Rotation of 14S-2	100° Rotation of 14S-7				
Insert Arrangement	14S-10	14S-12	14-3	16S-1	16S-3	16S-4
Service Rating	Inst.	A	A	A	B	D
Number of Contacts	4	3	1	7	1	2
Contact Size	16	16	8	16	16	16

						
Insert Arrangement	16S-5	16S-6	16S-8	16-2	16-7	16-9
Service Rating	A	A	A	E	A	A
Number of Contacts	3	3	5	1	1 2	2 2
Contact Size	16	16	16	12	8 16	12 16

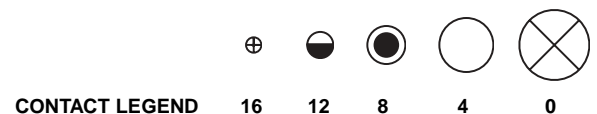

MS/Standard contact arrangements

front face of pin insert or rear face of socket insert illustrated

Insert Arrangement	16-10	16-11	16-12	16-13	18-1	18-3
Service Rating	A	A	A	A	B, C, F, G = A; Bal. = Inst.	D
Number of Contacts	3	2	1	2*	10	2
Contact Size	12	12	4	12	16	12
Insert Arrangement	18-4	18-5	18-6	18-7	18-8	18-9
Service Rating	D	D	D	B	A	Inst.
Number of Contacts	4	2 1	1	1	1 7	2 5
Contact Size	16	12 16	4	8	12 16	12 16
Insert Arrangement	18-10	18-11	18-12	18-13	18-14	18-15
Service Rating	A	A	A	A	A	A
Number of Contacts	4	5	6	1 3	1 1	4**
Contact Size	12	12	16	8 12	4 16	12
Insert Arrangement	18-16	18-17	18-19	18-20	18-22	18-24
Service Rating	C	Inst.	A	A	D	B, C, F, G = A; Bal. = Inst.
Number of Contacts	1	2 5	10	5	3	10
Contact Size	12	12 16	16	16	16	16

* A = Iron; B = Constantan
** A, C = Iron; B, D = Constantan



MS/Standard contact arrangements

front face of pin insert or rear face of socket insert illustrated



Insert Arrangement	18-29	18-30	18-31	20-2	20-3	20-4
Service Rating	A	A	A	D	D	D
Number of Contacts	5	5	5	1	3	4
Contact Size	16	16	16	0	12	12

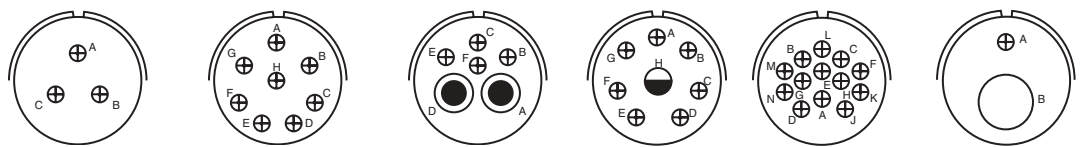

Insert Arrangement	20-6	20-7	20-8	20-9	20-11	20-12
Service Rating	D	A, B, H, G = D; C, D, E, F = A	Inst.	H = D; Bal. = A	Inst.	A
Number of Contacts	3	8	2 4	1 7	13	1 1
Contact Size	16	16	8 16	12 16	16	4 16

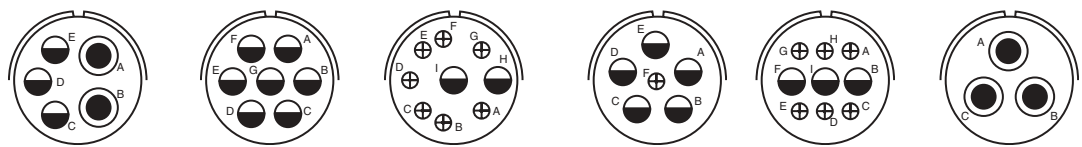

Insert Arrangement	20-14	20-15	20-16	20-17	20-18	20-19
Service Rating	A	A	A	A	A	A
Number of Contacts	2 3	7	2 7	5 1	3 6	3
Contact Size	8 12	12	12 16	12 16	12 16	8



CONTACT LEGEND

16 12 8 4 0

MS/Standard contact arrangements

front face of pin insert or rear face of socket insert illustrated



Insert Arrangement	20-20	20-21	20-22	20-23	20-24	20-25
Service Rating	A	A	A	A	A	Inst.
Number of Contacts	1 3	1 8	3 3	2	2 2	13
Contact Size	4 12	12 16	8 16	8	8 16	16



Insert Arrangement	20-27	20-29	20-30	20-33	22-1	22-2
Service Rating	A	A	Inst.	A	D	D
Number of Contacts	14	17	13	11	2	3
Contact Size	16	16	16	16	8	8



Insert Arrangement	22-4	22-5	22-6	22-7	22-8
Service Rating	A	D	D	E	E
Number of Contacts	2 2	2 4	2 1	1	2
Contact Size	8 12	12 16	8 16	0	12

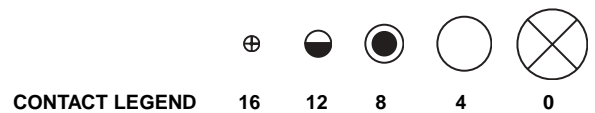

MS/Standard contact arrangements

front face of pin insert or rear face of socket insert illustrated

Insert Arrangement	22-9	22-10	22-11	22-12	22-13
Service Rating	E	E	B	D	E = D; A, B, C, D = A
Number of Contacts	3	4	2	2 3	4 1
Contact Size	12	16	16	8 16	12 16

Insert Arrangement	22-14	22-15	22-16	22-17	22-18
Service Rating	A	D = E; A, B, C, E, F = A	A	A = D; Bal. = A	A, B, F, G, H = D; C, D, E = A
Number of Contacts	19	5 1	3 6	1 8	8
Contact Size	16	12 16	12 16	12 16	16

Insert Arrangement	22-19	22-20	22-21	22-22	22-23
Service Rating	A	A	A	A	H = D; Bal. = A
Number of Contacts	14	9	1 2	4	8
Contact Size	16	16	0 16	8	12



MS/Standard contact arrangements

front face of pin insert or rear face of socket insert illustrated

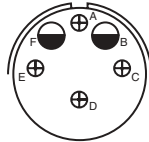

22-24
Service Rating C, D, E = D; A, B, F = A
Number of Contacts 2 4
Contact Size 12 16

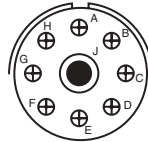

22-27
Service Rating J = D; Bal. = A
Number of Contacts 1 8
Contact Size 8 16

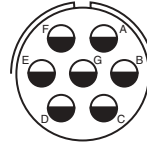

22-28
Service Rating A
Number of Contacts 7
Contact Size 12

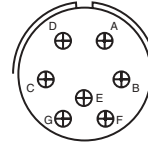

22-33
Service Rating A, B, C, D = D; E, F, G = A
Number of Contacts 7
Contact Size 16

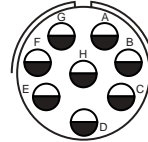

22-36
Service Rating H = D; Bal. = A*
Number of Contacts 8
Contact Size 12

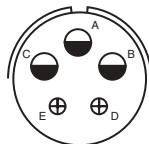

22-34
Service Rating D
Number of Contacts 3 2
Contact Size 12 16

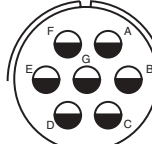

24-2
Service Rating D
Number of Contacts 7
Contact Size 12

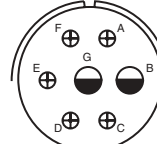

24-3
Service Rating D
Number of Contacts 2 5
Contact Size 12 16

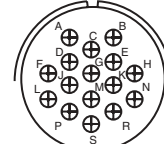

24-5
Service Rating A
Number of Contacts 16
Contact Size 16

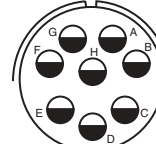

24-6
Service Rating A, G, H = D; Bal. = A
Number of Contacts 8
Contact Size 12



24-7
Service Rating A
Number of Contacts 2 14
Contact Size 12 16



24-9
Service Rating A
Number of Contacts 2
Contact Size 4



24-10
Service Rating A
Number of Contacts 7
Contact Size 8

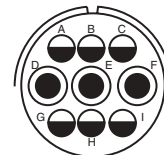

24-11
Service Rating A
Number of Contacts 3 6
Contact Size 8 12

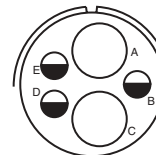

24-12
Service Rating A
Number of Contacts 2 3
Contact Size 4 12

* A, C, E, G = Iron
B, D, F, H = Constantan



MS/Standard contact arrangements

front face of pin insert or rear face of socket insert illustrated

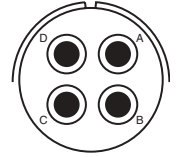
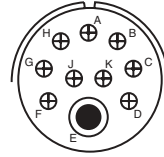
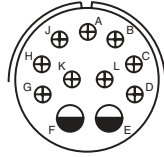
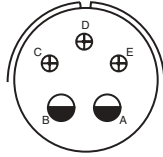
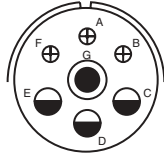

Insert Arrangement	24-16	
Service Rating	A, B, F, G = D; C, D, E, = A	
Number of Contacts	1 3 3	
Contact Size	8 12 16	

Insert Arrangement	24-17	
Service Rating	D	
Number of Contacts	2 3	
Contact Size	12 16	

Insert Arrangement	24-20	
Service Rating	D	
Number of Contacts	2 9	
Contact Size	12 16	

Insert Arrangement	24-21	
Service Rating	D	
Number of Contacts	1 9	
Contact Size	8 16	

Insert Arrangement	24-22	
Service Rating	D	
Number of Contacts	4	
Contact Size	8	

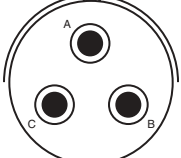
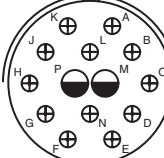
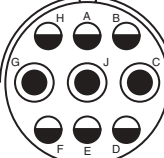
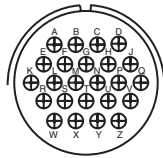
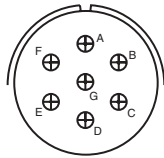

Insert Arrangement	24-27	
Service Rating	E	
Number of Contacts	7	
Contact Size	16	

Insert Arrangement	24-28	
Service Rating	Inst.	
Number of Contacts	24	
Contact Size	16	

Insert Arrangement	28-1	
Service Rating	A, J, E = D; Bal. = A	
Number of Contacts	3 6	
Contact Size	8 12	

Insert Arrangement	28-2	
Service Rating	D	
Number of Contacts	2 12	
Contact Size	12 16	

Insert Arrangement	28-3	
Service Rating	E	
Number of Contacts	3	
Contact Size	8	

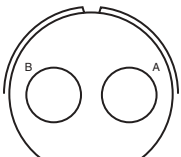
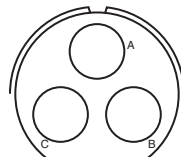
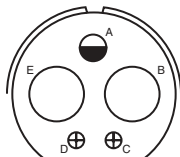

Insert Arrangement	28-4	
Service Rating	G, P, S = E; Bal. = D	
Number of Contacts	2 7	
Contact Size	12 16	

Insert Arrangement	28-5	
Service Rating	D	
Number of Contacts	2 1 2	
Contact Size	4 12 16	

Insert Arrangement	28-6	
Service Rating	D	
Number of Contacts	3	
Contact Size	4	

Insert Arrangement	28-7	
Service Rating	D	
Number of Contacts	2	
Contact Size	4	

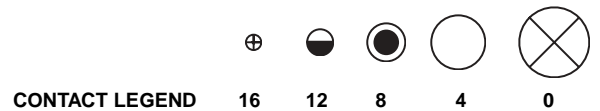

MS/Standard contact arrangements

front face of pin insert or rear face of socket insert illustrated



Insert Arrangement	28-8
Service Rating	L, M = E; B = D; Bal. = A
Number of Contacts	2 10
Contact Size	12 16

28-9
D
6 6
12 16

28-10
G = D; Bal. = A
2 2 3
4 8 12

28-11
A
4 18
12 16



Insert Arrangement	28-12
Service Rating	A
Number of Contacts	26
Contact Size	16

100° Rotation
of 28-12

28-13
A
26
16

28-15
A
35
16

28-16
A
20
16



Insert Arrangement	28-17
Service Rating	R = B; M, N, P = D; A to L = A
Number of Contacts	15
Contact Size	16

28-18
M = C; G, H, J, K, L = D; A, B = A; Bal. = Inst.
12
16

28-19
H, M = B; A, B = D; Bal. = A
4 6
12 16



MS/Standard contact arrangements

front face of pin insert or rear face of socket insert illustrated



Insert Arrangement
Service Rating
Number of Contacts
Contact Size

28-20
A
10 4
12 16

28-21
A
37
16

28-22
D
3 3
4 16

32-1
A = E; B, C, D, E = D
2 3
0 12

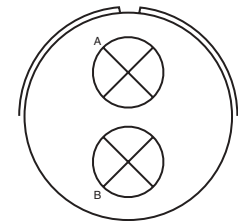

Insert Arrangement
Service Rating
Number of Contacts
Contact Size

32-2
E
3 2
4 16

32-3
D
1 2 2 4
0 4 12 16

32-4
F, J, K, N = A; Bal. = D
2 12
12 16

32-5
D
2
0

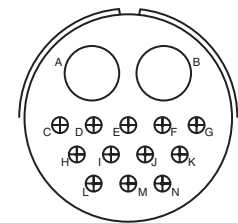
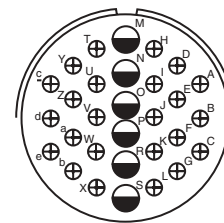
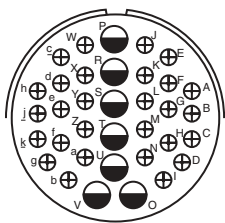

Insert Arrangement
Service Rating
Number of Contacts
Contact Size

32-6
A
2 3 2 16
4 8 12 16

32-7
A, B, h, j = Inst.; Bal. = A
7 28
12 16

32-8
A
6 24
12 16

32-9
D
2 12
4 16

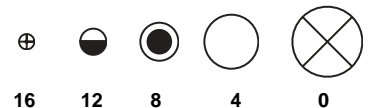

CONTACT LEGEND

16 12 8 4 0

MS/Standard contact arrangements

front face of pin insert or rear face of socket insert illustrated

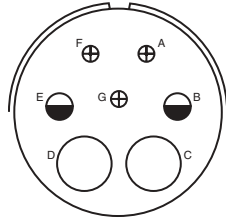

32-10

Insert Arrangement

Service Rating

Number of Contacts

Contact Size

A, F = E; G = B; B, E = D; C, D = A

2 2 3

4 8 16

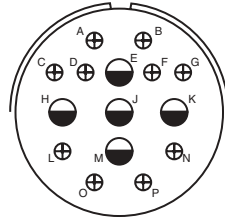

32-12

C, D, E, F, G = A; Bal. = D

5 10

12 16

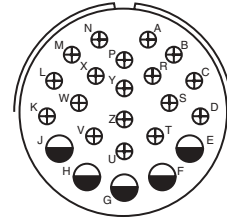

32-13

D

5 18

12 16

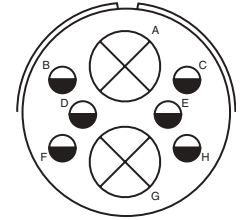

32-15

D

2 6

0 12



100° Rotation
of 32-6

32-16

Insert Arrangement

Service Rating

Number of Contacts

Contact Size

A

2 3 2 16

4 8 12 16

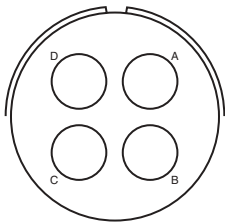

32-17

D

4

4



32-22

A

54

16

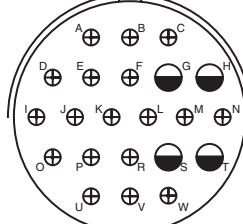

36-1

D

4 18

12 16

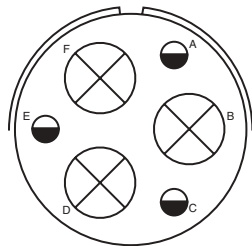

36-3

Insert Arrangement

Service Rating

Number of Contacts

Contact Size

D

3 3

0 12

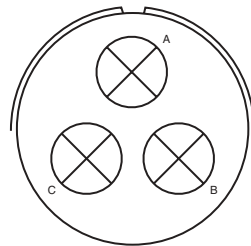

36-4

A = D; B, C = A

3

0

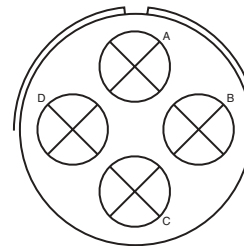

36-5

A

4

0

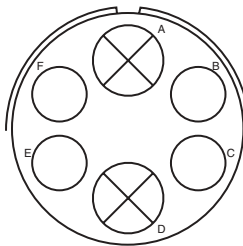

36-6

A

2 4

0 4



MS/Standard contact arrangements

front face of pin insert or rear face of socket insert illustrated

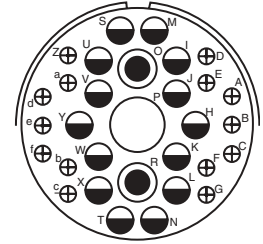
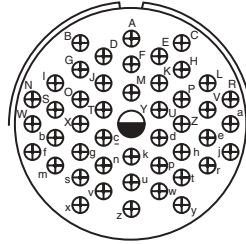

Insert Arrangement
Service Rating
Number of Contacts
Contact Size

36-7
A
7 40
12 16

36-8
A
1 46
12 16

36-9
A
1 2 14 14
4 8 12 16

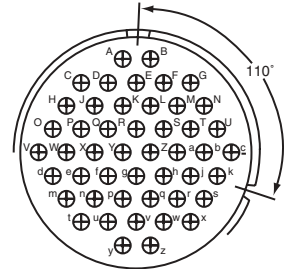
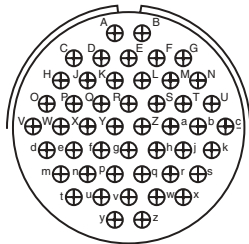

Insert Arrangement
Service Rating
Number of Contacts
Contact Size

36-10
A
48
16

**100° Rotation
of 36-10**
36-11
A
48
16

**110° Rotation
of 36-10**
36-12
A
48
16

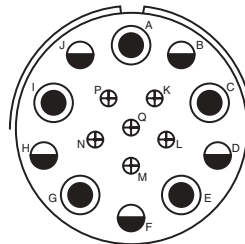
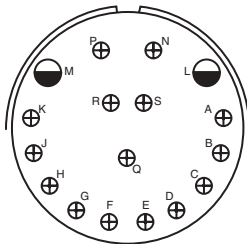

Insert Arrangement
Service Rating
Number of Contacts
Contact Size

36-13
N, P, Q = E; Bal. = A
2 15
12 16

36-14
D
5 5 6
8 12 16

36-15
M = D; Bal. = A
35
16

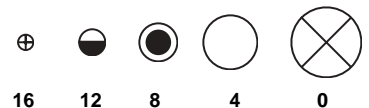

MS/Standard contact arrangements

front face of pin insert or rear face of socket insert illustrated



100° Rotation of 36-7

36-16

A

7 40

12 16



110° Rotation of 36-7

36-17

A

7 40

12 16



100° Rotation of 36-9

36-18

A

1 2 14 14

4 8 12 16

Insert Arrangement
Service Rating
Number of Contacts
Contact Size



36-20

A

2 2 30

8 12 16



36-52

A

52

16

Insert Arrangement
Service Rating
Number of Contacts
Contact Size

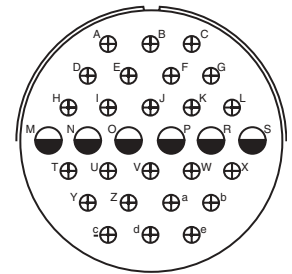

40-1

D

6 24

12 16



40-9

A

1 22 24

8 12 16

Insert Arrangement
Service Rating
Number of Contacts
Contact Size

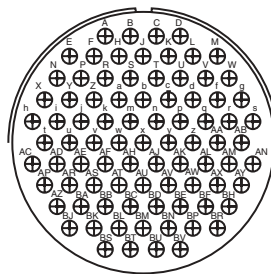

40-56

A

85

16

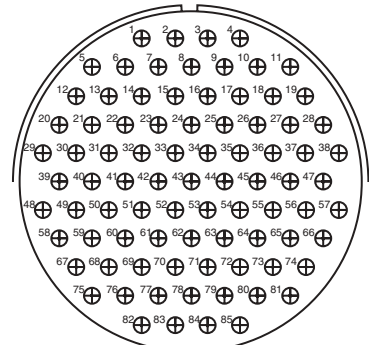

48-62

D

85

16



CONTACT LEGEND

16 12 8 4 0

Special contact arrangements

Requirements for more complex circuits prompted Amphenol to provide inserts not covered by the MS drawings. Illustrated here and on the following pages are insert layouts which have from one contact (high tension) to the 104 contact insert in shell size 44.

Many of these special inserts are also available in alternate keyway arrangements. Please contact Amphenol, Sidney, NY for additional information on special circuit application requirements.

front face of pin insert or rear face of socket insert illustrated

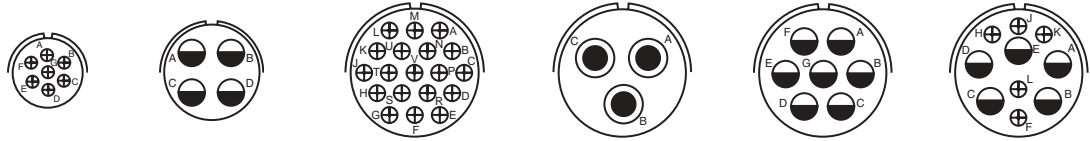

Insert Arrangement	14S-A7	16-59	20-26	20-51	20-57	20-58
Service Rating	A	A	A	A	A	A
Number of Contacts	7	4	19	3*	7*	5 5
Contact Size	16	12	16	8	12 for #14 or 16 wire	12 16



Insert Arrangement	20-59	20-66	20-79	22-63	22-65	22-70
Service Rating	A	A	H = D; Bal. = A	A	H = D; Bal. = A	A
Number of Contacts	3*	1 5	7* 1*	4 8	8*	8 5
Contact Size	8 for #10 or 12 wire	16 12 for #10 wire	16 12 for #16 wire	12 16	12 for #14 or 16 wire	12 16



Insert Arrangement	22-80	24-19	24-51	24-52	24-53	24-58
Service Rating	A	A	A	Hi-Volt	A	A
Number of Contacts	3*	12	5*	1	5*	3 3 7
Contact Size	8 for #10 or 12 wire	16	B, E for AN #10 or 12 wire A, C, D for AN #8 wire	12	8	8 12 16

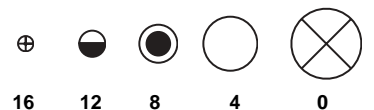

* Solderless

Special contact arrangements

front face of pin insert or rear face of socket insert illustrated

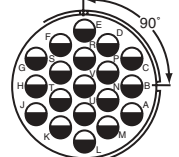

Insert Arrangement	24-59	24-60	24-65	24-66	24-67
Service Rating	A	A	A	D	Inst.
Number of Contacts	7 7	7*	11 4	7	19
Contact Size	12 16	8 for #10 or 12 wire	12 16	12	12



Insert Arrangement	24-71	24-75	24-79	24-80	24-84
Service Rating	A	A	A	Inst.	A
Number of Contacts	2* 5*	5 2	5	23	1 18
Contact Size	8 8 for #10 or 12 wire	8 8 for #16 wire	8	16	12 12 (Coax) RG-188/U or RG-174/U



Insert Arrangement	24-96	24-AJ	28-51	28-59
Service Rating	Inst.	A	A	A
Number of Contacts	28	25	12	7 10
Contact Size	16	16	12	12 16

* Solderless



Special contact arrangements

front face of pin insert or rear face of socket insert illustrated



Insert Arrangement	28-66	28-72	28-74	28-75	28-79
Service Rating	A	-	A	A	A
Number of Contacts	2 14	3	9* 4* 3*	9* 7*	7 9
Contact Size	8 12	4 (Coax) RG-59A/U or RG-62A/U	16 8 8 for #10 wire (S, T, R)	16 8 for #10 wire	8 16



Insert Arrangement	28-82	28-84	28-AY	32-14	32-25
Service Rating	D	A	A	D	A
Number of Contacts	2 4	9	4 5	13	25
Contact Size	8 12	8	4 16	12	12



Insert Arrangement	32-31	32-48	32-52	32-53
Service Rating	A	Inst.	D	t, u = E; Bal. = Inst.
Number of Contacts	31	48	6 2	5 37
Contact Size	16	16	12 0	12 16

* Solderless

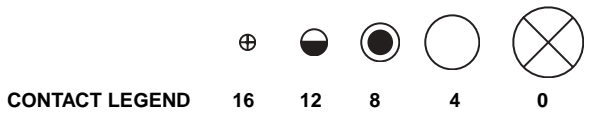

Special contact arrangements

front face of pin insert or rear face of socket insert illustrated

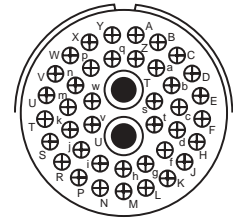
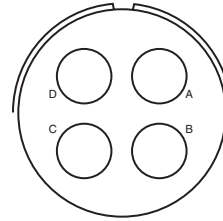
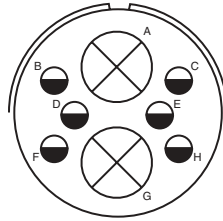
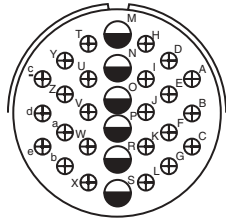

Insert Arrangement	32-56	32-57	32-58	32-59
Service Rating	A	**	-	A
Number of Contacts	24 6	6 2	4	40 2
Contact Size	16 12 for #10 wire	12 0 (Coax) RG-71/U	4 (Coax) RG-161/U or RG-179/U	16 8 (Coax) RG-161/U



Insert Arrangement	32-60	32-62	32-64	32-68
Service Rating	A	**	Inst.	A
Number of Contacts	15 8	2 1 2 16 2	54	12 4
Contact Size	16 8 (Coax) RG-124/U	4 8 12 16 8 (Coax) RG-124/U	16	16 4 (Coax) RG-58C/U

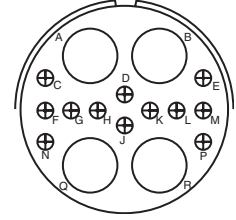
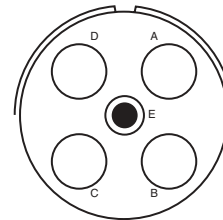
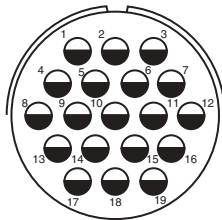
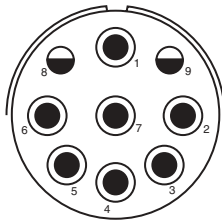
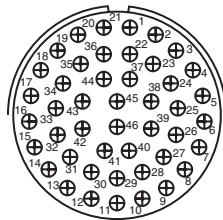

Insert Arrangement	32-73	32-75	32-76	32-79	32-82
Service Rating	A	8, 9 = D	A	D	A
Number of Contacts	46	2 7	19	4 1	4 12
Contact Size	16	12 8 (Coax) RG-180B/U	12	4 8	4 16

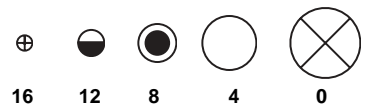

** Consult Amphenol, Sidney, NY for service rating of power contacts.

Special contact arrangements

front face of pin insert or rear face of socket insert illustrated



Insert Arrangement	32-AF	36-22	36-51	36-54
Service Rating	A	D	D	A
Number of Contacts	55	22	2 2	8 31
Contact Size	16	12	0 4	8 16



Insert Arrangement	36-55	36-59	36-60	36-64
Service Rating	A	A	**	-
Number of Contacts	31 8	50 3	40 7	4
Contact Size	16 8 for #6 wire	16 12 for #10 wire	16 12 for #10 wire	0 (Coax) RG-11/U, RG-12/U or RG-13/U



Insert Arrangement	36-65	36-71	36-73	36-74
Service Rating	-	A	-	A
Number of Contacts	4	3 50	7	43 1
Contact Size	0 (Coax) RG-59/U, RG-62/U or RG-71/U	12 16	4 (Coax) RG-62B/U	16 8 (Coax) RG-187/U



** Consult Amphenol, Sidney, NY for service rating of power contacts.

Special contact arrangements

front face of pin insert or rear face of socket insert illustrated



Insert Arrangement	36-75	36-76	36-77	36-78
Service Rating	A	A	D	A
Number of Contacts	48	47	7	2 12
Contact Size	16 for #14 wire	16	4	16 8



Insert Arrangement	36-79	36-80	36-83	36-85
Service Rating	A	A	-	M = D; Bal. = A
Number of Contacts	20	20	7	35
Contact Size	12	12 for #10 wire	4 (Coax) RG-58/U	16 for #12 wire



Insert Arrangement	36-97	36-99	36-AF	40-5
Service Rating	C	D	A	A
Number of Contacts	1	3 3 3 3	48	5
Contact Size	4/0	4 8 12 16	16	0



Special contact arrangements

front face of pin insert or rear face of socket insert illustrated



Insert Arrangement	40-10	40-30	40-35	40-53
Service Rating	A	A	D	A
Number of Contacts	4 9 16	29 1	35	60
Contact Size	4 8 16	12 4	12	16



Insert Arrangement	40-57	40-61	40-62
Service Rating	E	A	A
Number of Contacts	4	1 3 55	60
Contact Size	0	8 12 16	16



Insert Arrangement	40-63	40-64	40-66
Service Rating	A	-	-
Number of Contacts	61	3 20 13	4
Contact Size	16 for #14 wire	12 16 8 (Coax) RG-124/U	0 (Coax) RG-63B/U



Special contact arrangements

front face of pin insert or rear face of socket insert illustrated



Insert Arrangement 40-67
Service Rating A
Number of Contacts 1 10
Contact Size 16 4 (Coax) RG-59/U

Insert Arrangement 40-68
Service Rating A
Number of Contacts 21
Contact Size 8

Insert Arrangement 40-70
Service Rating A
Number of Contacts 61
Contact Size 16



Insert Arrangement 40-72
Service Rating A
Number of Contacts 1 10
Contact Size 16 4 (Coax) RG-9B/U

Insert Arrangement 40-73
Service Rating A
Number of Contacts 61
Contact Size 16

Insert Arrangement 40-74
Service Rating A
Number of Contacts 1 1 4
Contact Size 12 4 (Coax) RG-62/U 0 (Coax) RG-9B/U or RG-214/U



Insert Arrangement 40-75
Service Rating E
Number of Contacts 1 4
Contact Size 12 0

Insert Arrangement 40-80
Service Rating A
Number of Contacts 1 10
Contact Size 16 4

Insert Arrangement 40-81
Service Rating A
Number of Contacts 62
Contact Size 16 for #14 wire



Special contact arrangements

front face of pin insert or rear face of socket insert illustrated



40-82

Insert Arrangement
Service Rating
Number of Contacts
Contact Size

A
62
16



40-85

A
60
16 for #14 wire



40-86

-
4
0(Coax) RG-115A/U



40-87

D
7
4

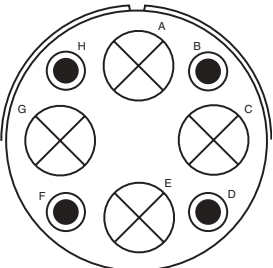

40-AD

Insert Arrangement
Service Rating
Number of Contacts
Contact Size

A
4 4
8 0

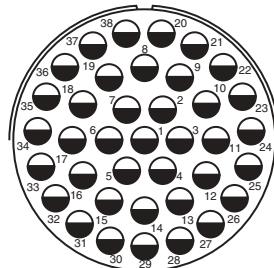

40-AG

A
38
12

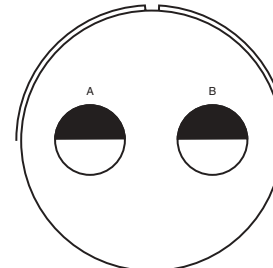

40-AP

E
2
4/0

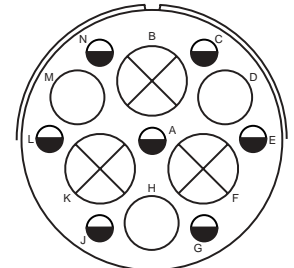

40-AR

Inst.
7 3 3
12 4 0



40-AS

Insert Arrangement
Service Rating
Number of Contacts
Contact Size

A
15 25
16 12

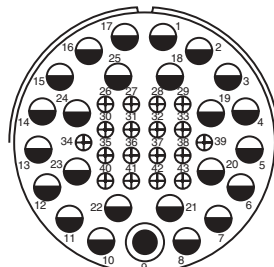

40-AT

A
24 18 1
12 16 8



40-AU

A
3 10 1
4 8 16



40-AV

D
3
2/0



CONTACT LEGEND

16 12 8 4 0 2/0 4/0

Special contact arrangements

front face of pin insert or rear face of socket insert illustrated



Insert Arrangement	44-52	44-53	48-51
Service Rating	A	A	A
Number of Contacts	104	18 18	42 10 4
Contact Size	16	16 8 (Coax) RG-124/U	16 8 0 (Coax) RG-41/U



Insert Arrangement	48-52	48-53
Service Rating	A	D
Number of Contacts	56 5	37
Contact Size	16 0 (Coax) RG-41/U	12



Special contact arrangements

front face of pin insert or rear face of socket insert illustrated



48-54

Insert Arrangement
Service Rating
Number of Contacts
Contact Size

A
42 10 4
16 8 0 (Coax) RG-59/U



48-55

A
68 2 2 6
16 12 8 4



48-57

Insert Arrangement
Service Rating
Number of Contacts
Contact Size

A
42 10 4
16 8 0



48-60

A
42 10 4
16 8 0 (Coax) RG-214/U



CONTACT LEGEND 16 12 8 4 0

Thermocouple contact availability

A complete line of cylindrical connectors containing thermocouple insert arrangements is available. The contact layout for a particular arrangement will be found in either the MS/Standard contact arrangement section, pages 26-37, or the Special contact arrangement section, pages 38-48. All thermocouple contact layouts may contain either iron, alumel, chromel, constantan, standard (copper) or brass (dummy) contacts. See the thermocouple tabulations on the following pages.

The following abbreviations are used in the contact material column in the charts that follow. Also, thermocouple contacts are color coded as shown. (This identification is made by means of small dots of stain on the solder well end of the contact).

Abbreviation	Material	Color Code
Ir.	Iron	Black
Con.	Constantan	Yellow
Cu.	Copper Alloy	N/A
Ch.	Chromel	White
Al.	Alumel	Green
Dummy	Brass	N/A

WIRE WELL DATA

Contact Size	Well Inside Dia. +.004 -.002	Well Depth +.031 -.000	Solder Well Barrel Outside Dia.
12	.125	.250	.166 ±.003
16	.094	.188	.125 ^{+.002} -.004

RECOMMENDED WIRE

I Chromel - Alumel	Use wire in accordance with MIL-W-5848
II Iron - Constantan	Use wire in accordance with MIL-W-5845

Thermocouple contact arrangements

Shell Size and Arrg.	Similar to MS Arrg.	Total Contacts	Contact Size		Pin Insert Rotation C W	Contact Material
			12	16		
10SL-51	10SL-4	2		2	45°	A = Ir.; B = Con.
10SL-52	10SL-4	2		2	45°	A = Cu.; B = Con.
10SL-53	10SL-4	2		2	45°	A = Al.; B = Ch.
10SL-54	10SL-3	3		3	None	A = Ir.; B = Con.; C = Cu.
10SL-55	10SL-3	3		3	None	A = Al.; B = Ch.; C = Cu.
10SL-56	10SL-4	2		2	None	A = Al.; B = Ch.
10SL-57	10SL-4	2		2	None	A = Ch.; B = Con.
10SL-58	10SL-3	3		3	None	A = Ch.; B = Al.; C = Cu.
10SL-59	10SL-4	2		2	None	A = Ch.; B = Al.
10SL-60	10SL-4	2		2	None	A = Ir.; B = Con.
10SL-61	10SL-4	2		2	None	A = Cu.; B = Con.
10SL-62	10SL-3	3		3	None	A = Cu.; B = Al.; C = Ir.
10SL-63	10SL-3	3		3	None	A, C = Con.; B = Ch.
10SL-64	10SL-3	3		3	None	A, C = Ch.; B = Al.
12S-51	12S-3	2		2	315°	A = Ch.; B = Al.
12S-54	12S-3	2		2	315°	A = Ir.; B = Con.
12S-55	12S-3	2		2	45°	A = Cu.; B = Con.
12S-56	12S-3	2		2	None	A = Al.; B = Ch.
12S-57	12S-3	2		2	60°	A = Ch.; B = Al.
12S-58	12S-3	2		2	120°	A = Ir.; B = Con.
12S-59	12S-3	2		2	None	A = Ir.; B = Con.
12S-60	12S-3	2		2	None	A = Cu.; B = Con.
12S-61	12S-3	2		2	None	A = Ch.; B = Con.
12S-62	12S-3	2		2	None	A = Ch.; B = Al.
14S-51	14S-9	2		2	90°	A = Al.; B = Ch.
14S-52	14S-2	4		4	45°	A, B = Cu.; C = Al.; D = Ch.
14S-53	14S-9	2		2	90°	A = Ir.; B = Con.
14S-54	14S-6	6		6	45°	A, C, E = Ir.; B, D, F = Con.
14S-55	14S-2	4		4	45°	A, C = Ir.; B, D = Con.
14S-56	14S-2	4		4	45°	A = Ir.; B = Con.; C, D = Cu.
14S-57	14S-2	4		4	45°	A, C = Al.; B, D = Ch.
14S-58	14S-7	3		3	45°	A = Al.; B = Ch.; C = Cu.
14S-59	14S-9	2		2	90°	A = Cu.; B = Con.
14S-60	14S-9	2		2	None	A = Al.; B = Ch.
14S-61	14S-6	6		6	45°	A = Al.; B = Ch.; C = Ir.; D = Con.; E, F = Cu.
14S-63	14S-6	6		6	None	A, C = Al.; B, D = Ch.; E = Ir.; F = Con.
14S-64	14S-2	4		4	None	A, C = Con.; B, D = Cu.
14S-65	14S-6	6		6	None	A, C, E = Cu.; B, D, F = Con.
14S-67	14S-6	6		6	None	A = Al.; B = Ch.; Balance = Cu.
14S-68	14S-2	4		4	45°	A = Ch.; B = Con.; C, D = Cu.
14S-69	14S-7	3		3	None	A = Con.; B = Ch.; C = Cu.
14S-70	14S-2	4		4	None	A, D = Ch.; B, C = Al.
14S-71	14S-2	4		4	None	A, B, D = Cu.; C = Con.
14S-72	14S-9	2		2	None	A = Con.; B = Cu.
14S-73	14S-2	4		4	None	A, B = Cu.; C = Al.; D = Ch.

Thermocouple contact arrangements

Shell Size and Arrg.	Similar to MS Arrg.	Total Contacts	Contact Size		Pin Insert Rotation C W	Contact Material
			12	16		
14S-74	14S-2	4		4	None	A, B = Ch.; C, D = Al.
14S-75	14S-2	4		4	None	A, B = Cu.; C, D = Con.
14S-76	14S-2	4		4	None	A, C = Al.; B, D = Ch.
14S-77	14S-2	4		4	None	A, D = Al.; B, C = Ch.
14S-78	14S-9	2		2	None	A = Ch.; B = Al.
16S-52	16S-4	2		2	None	A = Ch.; B = Al.
16S-54	16S-1	7		7	None	A = Al.; B = Ch.; Balance = Cu.
16S-55	16S-1	7		7	None	A = Con.; Balance = Cu.
16-52	16-11	2	2		90°	A = Al.; B = Ch.
16-53	16-9	4	2	2	70°	A = Al.; C = Ch.; B, D = Cu.
16-55	16-10	3	3		45°	A = Al.; B = Ch.; C = Cu.
16-56	16-13	2	2		90°	A = Con.; B = Cu.
16-57	16-10	3	3		None	A = Al.; B = Cu.; C = Ch.
16-58	16-10	3	3		None	A = Con.; B, C = Cu.
16-60	16-13	2	2		None	A = Al.; B = Ch.
16-62	16-11	2	2		None	A = Con.; B = Cu.
18-51	18-12	6		6	None	A = Ir.; B, E = Con.; D = Cu.; C, F = Dummy
18-52	18-11	5	5		None	A = Ir.; B = Con.; C = Ch.; D = Al.; E = Dummy
18-53	18-12	6		6	None	A, D = Ir.; B, E = Con.; C, F = Dummy
18-54	18-15	4	4		None	A, C = Al.; B, D = Ch.
18-56	18-1	10		10	45°	A, C, E, G, I = Ir.; B, D, F, H, J = Con.
18-57	18-12	6		6	45°	A, C, E = Al.; B, D, F = Ch.
18-59	18-12	6		6	45°	A, C = Ir.; B, E, F = Con.; D = Cu.
18-60	18-11	5	5		45°	A, D = Al.; B, C, = Ch.; E = Cu.
18-61	18-12	6		6	None	A, C = Ir.; B, D = Con.; E = Ch.; F = Al.
18-62	18-12	6		6	None	A, B, C = Ir.; D, E, F = Con.
18-63	18-15	4	4		None	A, C = Con.; B, D = Cu.
18-65	18-12	6		6	None	A = Ir.; B = Con.; Balance = Cu.
18-66	18-1	10		10	None	A, C, E, G, I = Cu.; B, D, F, H, J = Con.
18-67	18-12	6		6	None	A, C, E = Cu.; B, D, F = Con.
18-68	18-11	5	5		None	A, D = Al.; B, C = Ch.; E = Cu.
18-69	18-1	10		10	None	A = Al.; B = Ch.; Balance = Cu.
18-70	18-11	5	5		None	A = Ir.; B = Con.; C = Ch.; D = Al.; E = Cu.
18-71	18-15	4	4		None	A = Con.; Balance = Cu.
18-72	18-15	4	4		None	D = Con.; Balance = Cu.
18-73	18-9	7	2	5	None	A = Al.; D = Ch.; Balance = Cu.
18-74	18-12	6		6	None	A = Ch.; B = Al.; D = Ir.; E = Cu.; C, F = Con.
20-52	20-4	4	4		315°	A = Ir.; B = Con.; C = Ch.; D = Al.
20-56	20-7	8		8	45°	A, B, G, H = Ir.; C, D, E, F = Con.
20-60	20-7	8		8	45°	D = Ch.; E = Al.; Balance = Cu.
20-61	20-29	17		17	45°	A, B, M = Cu.; Balance = Con.
20-62	20-15	7	7		80°	A, C, E = Al.; B, D, F = Ch.; G = Cu.
20-64	20-27	14		14	None	A = Al.; C = Ch.; Balance = Cu.

Thermocouple contact arrangements

Shell Size and Arrg.	Similar to MS Arrg.	Total Contacts	Contact Size		Pin Insert Rotation C W	Contact Material
			12	16		
20-65	20-27	14		14	None	A, B, C, D, E, F, G = Ir.; H, I, J, K, L, M, N = Con.
20-67	20-16	9	2	7	None	H = Al.; I = Ch.; Balance = Cu.
20-68	20-7	8		8	None	A, B, G, H = Con.; C, D, E, F = Cu.
20-69	20-27	14		14	None	A, B, C, D, E, F, G = Cu.; H, I, J, K, L, M, N = Con.
20-70	20-29	17		17	None	A, C, E, G, J, L, N, R, T = Ir.; B, D, F, H, K, M, P, S = Con.
20-71	20-29	17		17	None	S = Al.; R = Ch.; Balance = Cu.
20-74	20-29	17		17	None	A, C, E, G, J, L, N, R = Ir.; B, D, F, H, K, M, P, S = Con.; T = Cu.
20-75	20-15	7	7		None	G = Al.; Balance = Ch.
20-77	20-16	9	2	7	None	A = Con.; Balance = Std.
20-80	20-27	14		14	None	A, C, E, G, I, K, M = Cu.; B, D, F, H, J, L, N = Con.
20-81	20-27	14		14	None	A, C, E, G, I, K, M = Ch.; B, D, F, H, J, L, N = Al.
20-82	20-29	17		17	None	A, C, E, G, J, L, N, R = Al.; B, D, F, H, K, M, P, S = Ch.; T = Cu.
22-36	22-23	8	8		347°	A, C, E, G = Ir.; B, D, F, H = Con.
22-57	22-14	19		19	45°	A, C, E, G, J, L, N, R = Ir.; B, D, F, H, K, M, P, S = Con.; T, U, V = Cu.
22-60	22-14	19		19	45°	U = Al.; N = Ch.; Balance = Cu.
22-62	22-23	8	8		60°	A, B, F, G = Al.; C, D, E, H = Ch.
22-68	22-19	14		14	45°	A, C, E, G, J, L, M = Ir.; B, D, F, H, K, P, N = Con.
22-69	22-19	14		14	45°	A, C, E, G, J, L, M = Cu.; B, D, F, H, K, P, N = Con.
22-71	22-14	19		19	None	V = Al.; U = Ch.; Balance = Cu.
22-72	22-5	6	2	4	None	B = Al.; E = Ch.; Balance = Cu.
22-73	22-5	6	2	4	None	E = Al.; B = Ch.; Balance = Cu.
22-74	22-23	8	8		None	A, C, E, G = Ir.; B, D, F, H = Con.
22-75	22-23	8	8		None	A = Al.; B, D, G, H = Cu.; C = Ch.; E = Ir.; F = Con.
22-76		21		21	None	W = Con.; Balance = Cu.
22-77	22-19	14		14	None	B, D, F, H, J, K, M, P = Cu.; A, E, L = Ir.; C, G, N = Con.
22-78	22-14	19		19	None	A, C, E, G, H, K, M, P, R, T = Con.; Balance = Cu.
22-79	22-10	4		4	None	A, C, = Con.; B, D = Cu.
24-56	24-20	11	2	9	45°	E = Al.; F = Ch.; Balance = Cu.
24-57	24-28	24		24	45°	A, C, J, V, Y, W, K, E, H, U, S, M = Ch.; Balance = Al.
24-62	24-28	24		24	None	A, C, E, G = Ir.; B, D, F, H = Con.; R, T = Ch.; S, U = Al.; Balance = Cu.
24-63	24-28	24		24	None	A, C, E, G, J, L, K, N, S, U, W, Y = Cu.; B, D, F, H, Q, R, M, P, T, V, X, Z = Con.
24-64	24-5	16		16	None	A, B, C, D, E, F, G, H = Ir.; J, K, L, M, N, P, R, S = Con.
24-68	24-28	24		24	None	D = Con.; Balance = Cu.
24-81	24-7	16	2	14	None	A, C, E, G, I, K, M, N, P = Cu.; B, D, F, H, J, L, O = Con.
28-53	28-11	22	4	18	45°	J, L = Al.; K, M = Ch.; Balance = Cu.
28-58	28-20	14	10	4	45°	A, C, E, G, K, M = Al.; B, D, F, H, L, N = Ch.; J, P = Cu.
28-61	28-21	37		37	45°	A, C, J, Z, m, r, n, a, K, F, H, X, k, h, T, M, N, d = Ir.; Balance = Con.
28-63	28-20	14	10	4	45°	A, C, E, G, J = Al.; B, D, F, H, P = Ch.; Balance = Cu.
28-64	28-15	35		35	None	A, d = Al.; B, j = Ch.; C, D, E, F, G, N, P, R, S, H, J, K, L, M, W, X, Y, Z = Con.; Balance = Cu.
28-65	28-12	26		26	None	A, C, E, G, J, L, N, R, T, V = Ir.; X, Z = Al.; B, D, F, H, K, M, P, S, U, W = Con.; Y, a = Ch.; b, d = Cu.
28-67	28-16	20		20	None	U = Con.; Balance = Cu.
28-68	28-15	35		35	45°	T = Al.; U = Ch.; Balance = Cu.

MS/Standard accessories

MS/Standard Accessories

MS3057-A style cable clamp, MS3420 sleeve

The MS3057-A style cable clamp was designed for use with jacketed cable or wires protected by tubing. Both clamping halves float for maximum strain relief. For unjacketed cable or wires, use corresponding MS3420 sleeve. To order clamp with sleeve, add -1 to the 97 - number. Two telescoping sleeves are furnished with shells sizes 24 and larger.

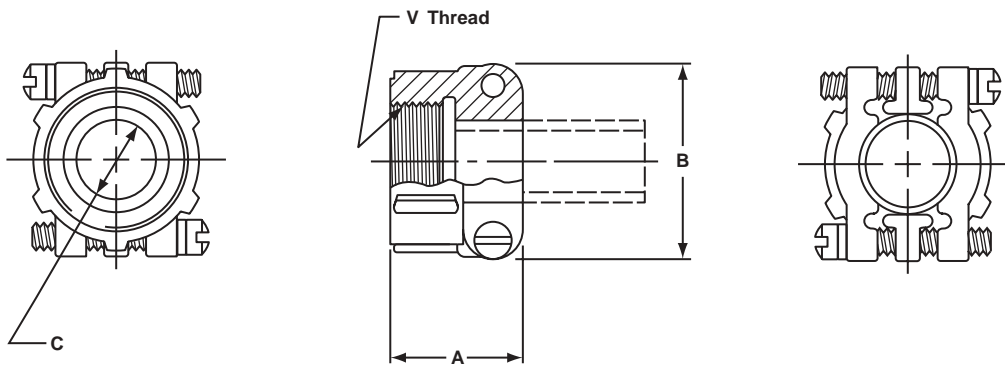

Shell Size	Amphenol Number	A ±.031	B Max.	C Dia. Min.	V Thread
10SL, 12S	97-3057-1004	.795	.842	.3125	.6250-24
14, 14S	97-3057-1007	.850	.995	.4375	.7500-20
16, 16S	97-3057-1008	.920	1.120	.5625	.8750-20
18	97-3057-1010	.920	1.216	.6250	1.0000-20
20, 22	97-3057-1012	.927	1.403	.7500	1.1875-18
24, 28	97-3057-1016	1.015	1.683	.9375	1.4375-18
32	97-3057-1020	1.095	2.050	1.2500	1.7500-18
36	97-3057-1024	1.156	2.245	1.3750	2.0000-18

Sleeve MS Part No.	Amphenol Number	A ±.005	B ±.005	C ±.010	D ±.031
3420-3	9779-513-3	.130	.210	.374	2.875
3420-4	9779-513-4	.220	.302	.500	2.750
3420-6	9779-513-6	.312	.427	.614	2.625
3420-8	9779-513-8	.437	.552	.739	2.500
3420-10	9779-513-10	.562	.615	.889	2.375
3420-12	9779-513-12	.625	.740	1.084	2.250
3420-16	9779-513-16	.750	.927	1.309	2.125
3420-20	9779-513-20	.937	1.240	1.592	2.000
3420-24	9779-513-24	1.250	1.365	1.842	1.875



MS/Standard Accessories

10-305200 cable clamp, MS3420()A sleeve

Included in the design of the 10-305200 clamp are features such as a shorter overall length, greater reduction of close-down diameters by the use of accessory sleeves and waterproofing between the clamp and attaching shells. Finish is cadmium plating per QQ-P-146 type II, class 3 with olive drab chromate after-treatment. This is a suitable replacement clamp for M85049/1.



Shell Size	Clamp Part No.	A Thread Class 2B	B Dia.		E Dia. $\pm .016$	F $\pm .010$	G $+ .020$ $- .000$	Sleeve MS Part No.	H Dia.	
			Free	Closed					Free $\pm .016$	Closed
8S, 10S	10-305200-103	.5000-28UNEF	.219	.027	.719	.797	1.010	3420-3A	.125	.000
10SL, 12, 12S	10-305200-123	.6250-24NEF	.312	.094	.844	.891	1.010	3420-4A	.219	.010
14, 14S	10-305200-143	.7500-20UNEF	.438	.230	.969	1.016	1.010	3420-6A 3420-4A	.312 .219	.114 .020
16, 16S	10-305200-163	.8750-20UNEF	.531	.316	1.094	1.109	1.010	3420-8A 3420-6A	.438 .312	.222 .085
18	10-305200-183	1.0000-20UNEF	.625	.378	1.219	1.219	1.041	3420-10A 3420-6A	.438 .312	.200 .085
20, 22	10-305200-203	1.1875-18NEF	.750	.445	1.406	1.469	1.151	3420-12A 3420-8A	.541 .438	.270 .177
24, 28	10-305200-243	1.4375-18NEF	.938	.611	1.656	1.656	1.151	3420-16A 3420-12A 3420-8A	.750 .541 .438	.433 .260 .186
32	10-305200-323	1.7500-18NS	1.250	.922	2.000	2.125	1.291	3420-20A 3420-16A 3420-12A	.938 .750 .541	.620 .442 .273
36	10-305200-363	2.0000-18NS	1.375	.922	2.250	2.250	1.510	3420-24A 3420-18A 3420-16A	1.125 .938 .750	.682 .504 .358
40	10-305200-403	2.2500-16UN	1.625	1.180	2.500	2.500	1.510	3420-28A 3420-20A 3420-16A	1.250 .938 .750	.816 .514 .368

MS/Standard Accessories

10-350349 cable clamp, MS3420()A sleeve

Cable clamp 10-350349 features a reduced close-down diameter, a positive, physical moisture barrier, and cadmium olive drab plating with a chromate after-treatment. It has a slightly longer overall length than the 10-305200. This is a suitable replacement clamp for M85049/2.



Shell Size	Clamp Part No.	A Thread Class 2A (Plated)	B Dia.		M Max.	Y Max.	Sleeve MS Part No.	H Dia.	
			Free	Closed				Free ±.016	Closed
8S, 10S	10-350349-103	.5000-28UNEF	.219	.027	1.313	.812	3420-3A	.125	.000
10SL, 12, 12S	10-350349-123	.6250-24UNEF	.312	.094	1.313	.906	3420-4A	.219	.010
14, 14S	10-350349-143	.7500-20UNEF	.438	.230	1.313	1.031	3420-6A 3420-4A	.312 .219	.114 .020
16, 16S	10-350349-163	.8750-20UNEF	.531	.316	1.313	1.125	3420-8A 3420-6A	.438 .312	.222 .085
18	10-350349-183	1.0000-20UNEF	.625	.378	1.391	1.234	3420-10A 3420-6A	.438 .312	.200 .085
20, 22	10-350349-203	1.1875-18UNEF	.750	.445	1.406	1.484	3420-12A 3420-8A	.541 .438	.270 .177
24, 28	10-350349-243	1.4375-18UNEF	.938	.611	1.516	1.671	3420-16A 3420-12A 3420-8A	.750 .541 .438	.433 .260 .186
32	10-350349-323	1.7500-18UNS	1.250	.922	1.766	2.188	3420-20A 3420-16A 3420-12A	.938 .750 .541	.620 .442 .273
36	10-350349-363	2.0000-18UNS	1.375	.922	2.031	2.344	3420-24A 3420-18A 3420-16A	1.125 .938 .750	.682 .504 .358
40	10-350349-403	2.2500-16UN	1.625	1.180	2.031	2.594	3420-28A 3420-20A 3420-16A	1.250 .938 .750	.816 .514 .368
44	10-350349-443	2.5000-16UN	1.865	1.427	2.186	2.812	3420-32A 3420-28A 3420-20A	1.625 1.250 .938	1.229 .897 .638

MS/Standard Accessories

10-74900 series cable clamp

For waterproofing individual connectors, Amphenol offers a simple modification of the M85049/1 cable clamp. This assembly incorporates a rubber grommet with holes for individual wires in place of the gland. As the assembly is tightened, the grommet is compressed around each wire, sealing moisture

out. Based on standard MS insert arrangements, 97 different conductor combinations can be waterproofed. This assembly is identified as the 10-749XX (shell size) series and is used with the feed-thru shells on pages 59 and 60.

Order Number	Total Thread Size	Total No. of Holes	No. & Size of Holes					
			No. 16 .115	No. 12 .150	No. 8 .200	No. 4 .310	No. 0 .445	
10-74910-2	.5000-28UNEF-2B	1	1					
10-74911-3	.6250-24NEF-2B	3	3					
10-74911-4	.6250-24NEF-2B	2	2					
10-74912-3	.6250-24NEF-2B	2	2					
10-74912-4	.6250-24NEF-2B	1	1					
10-74913-5	.6250-24NEF-2B	1		1				
10-74914-2	.7500-20UNEF-2B	4	4					
10-74914-4	.7500-20UNEF-2B	1	1					
10-74914-5	.7500-20UNEF-2B	5	5					
10-74914-6	.7500-20UNEF-2B	6	6					
10-74914-7	.7500-20UNEF-2B	3	3					
10-74914-9	.7500-20UNEF-2B	2	2					
10-74915-3	.7500-20UNEF-2B	1			1			
10-74916-1	.8750-20UNEF-2A	7	7					
10-74916-4	.8750-20UNEF-2A	2	2					
10-74916-5	.8750-20UNEF-2A	3	3					
10-74916-8	.8750-20UNEF-2A	5	5					
10-74917-7	.8750-20UNEF-2A	3	2		1			
10-74917-9	.8750-20UNEF-2A	4	2	2				
10-74917-10	.8750-20UNEF-2A	3		3				
10-74917-11	.8750-20UNEF-2A	2		2				
10-74917-12	.8750-20UNEF-2A	1				1		
10-74918-1	1.0000-20UNEF-2B	10	10					
10-74918-5	1.0000-20UNEF-2B	3	1	2				
10-74918-8	1.0000-20UNEF-2B	8	7	1				
10-74918-9	1.0000-20UNEF-2B	7	5	2				
10-74918-10	1.0000-20UNEF-2B	4		4				
10-74918-11	1.0000-20UNEF-2B	5		5				
10-74918-12	1.0000-20UNEF-2B	6	6					
10-74918-15	1.0000-20UNEF-2B	4		4				
10-74918-22	1.0000-20UNEF-2B	3	3					
10-74920-6	1.1875-18NEF-2B	3	3					
10-74920-7	1.1875-18NEF-2B	8	8					
10-74920-8	1.1875-18NEF-2B	6	4		2			
10-74920-9	1.1875-18NEF-2B	8	7	1				
10-74920-15	1.1875-18NEF-2B	7		7				
10-74920-18	1.1875-18NEF-2B	9	6	3				
10-74920-19	1.1875-18NEF-2B	3			3			
10-74920-20	1.1875-18NEF-2B	4		3		1		
10-74920-21	1.1875-18NEF-2B	9	8	1				
10-74920-22	1.1875-18NEF-2B	6	3		3			
10-74920-23	1.1875-18NEF-2B	4	2		2			
10-74920-24	1.1875-18NEF-2B	4	2		2			
10-74920-27	1.1875-18NEF-2B	14	14					
10-74920-29	1.1875-18NEF-2B	17	17					
10-74922-4	1.8750-18NEF-2B	4		2	2			
10-74922-5	1.8750-18NEF-2B	6	4	2				
10-74922-7	1.8750-18NEF-2B	1					1	
10-74922-13	1.8750-18NEF-2B	5	1	4				
10-74922-14	1.8750-18NEF-2B	19	19					

Order Number	Total Thread Size	Total No. of Holes	No. & Size of Holes					
			No. 16 .115	No. 12 .150	No. 8 .200	No. 4 .310	No. 0 .445	
10-74922-16	1.8750-18NEF-2B	9	6	3				
10-74922-20	1.8750-18NEF-2B	9	9					
10-74922-21	1.8750-18NEF-2B	3	2					1
10-74922-22	1.8750-18NEF-2B	4				4		
10-74922-23	1.8750-18NEF-2B	8		8				
10-74924-2	1.4375-18NEF-2B	7		7				
10-74924-5	1.4375-18NEF-2B	16	16					
10-74924-6	1.4375-18NEF-2B	8		8				
10-74924-7	1.4375-18NEF-2B	16	14	2				
10-74924-9	1.4375-18NEF-2B	2					2	
10-74924-10	1.4375-18NEF-2B	7				7		
10-74924-11	1.4375-18NEF-2B	9		6	3			
10-74924-12	1.4375-18NEF-2B	5		3			2	
10-74924-17	1.4375-18NEF-2B	5	3	2				
10-74924-20	1.4375-18NEF-2B	11	9	2				
10-74924-22	1.4375-18NEF-2B	4				4		
10-74928-2	1.4375-18NEF-2B	14	12	2				
10-74928-6	1.4375-18NEF-2B	3					3	
10-74928-9	1.4375-18NEF-2B	12	6	6				
10-74928-10	1.4375-18NEF-2B	7		3	2	2		
10-74928-11	1.4375-18NEF-2B	22	18	4				
10-74928-12	1.4375-18NEF-2B	26	26					
10-74928-15	1.4375-18NEF-2B	35	35					
10-74928-16	1.4375-18NEF-2B	20	20					
10-74928-17	1.4375-18NEF-2B	15	15					
10-74928-18	1.4375-18NEF-2B	12	12					
10-74928-19	1.4375-18NEF-2B	10	6	4				
10-74928-21	1.4375-18NEF-2B	37	37					
10-74928-22	1.4375-18NEF-2B	6	3				3	
10-74928-51*	1.4375-18NEF-2B	12		12				
10-74932-2	1.7500-18NS-2B	5	2				3	
10-74932-5	1.7500-18NS-2B	2						2
10-74932-6	1.7500-18NS-2B	23	16	2	3	2		
10-74932-7	1.7500-18NS-2B	35	28	7				
10-74932-8	1.7500-18NS-2B	30	24	6				
10-74932-9	1.7500-18NS-2B	14	12				2	
10-74932-13	1.7500-18NS-2B	23	18	5				
10-74932-15	1.7500-18NS-2B	8		6				2
10-74932-17	1.7500-18NS-2B	4					4	
10-74936-1	2.0000-18NS-2B	22	18	4				
10-74936-4	2.0000-18NS-2B	3						3
10-74936-5	2.0000-18NS-2B	4						4
10-74936-6	2.0000-18NS-2B	6					4	2
10-74936-7	2.0000-18NS-2B	47	40	7				
10-74936-8	2.0000-18NS-2B	47	46	1				
10-74936-10	2.0000-18NS-2B	48	48					
10-74936-14	2.0000-18NS-2B	16	6	5	5			
10-74936-52*	2.0000-18NS-2B	52	52					
10-74940-9	2.2500-16UN-2B	47	24	22	1			
10-74940-56*	2.2500-16UN-2B	85	85					

NOTE: The 74900 series is available with a cadmium plate clear chromate after-treatment, designated by 10-74900. 71-74900 is the base number to use if a cadmium plate olive drab chromate after-treatment is required.

* Proprietary insert arrangements.

MS/Standard Accessories thru-bulkhead shells

10-113276-XXX*

For Open Wire Waterproofing

Similar to the 10-37090 shell in construction, but substitutes jam nut mounting. The 10-74900 grommet seats against the undercut for moisture-proofing between the clamp assembly and the shell.



Shell Size	Order Number	A Thread	B +.010 -.000	C ±.005	D ±.010	E ±.010	F ±.010
10	10-113276-10X	.5000-28UNEF-2A	.203	1.000	.875	1.031	.309
12	10-113276-12X	.6250-24NEF-2A	.328	1.000	1.000	1.156	.354
14	10-113276-14X	.7500-20UNEF-2A	.453	1.000	1.125	1.312	.397
16	10-113276-16X	.8750-20UNEF-2A	.578	1.062	1.250	1.438	.442
18	10-113276-18X	1.0000-20UNEF-2A	.676	1.062	1.375	1.562	.486
20	10-113276-20X	1.1875-18NEF-2A	.801	1.062	1.688	1.875	.596
22	10-113276-22X	1.1875-18NEF-2A	.906	1.062	1.688	1.875	.596
24	10-113276-24X	1.4375-18NEF-2A	1.016	1.062	1.938	2.188	.685
28	10-113276-28X	1.4375-18NEF-2A	1.130	1.062	1.938	2.188	.685
32	10-113276-32X	1.7500-18NS-2A	1.438	1.062	2.250	2.625	.795
36	10-113276-36X	2.0000-18NS-2A	1.678	1.281	2.500	2.875	.884
40	10-113276-40X	2.2500-16UN-2A	1.914	1.344	2.750	3.125	.972

10-37090-XXX*

For Open Wire Waterproofing

A feed-thru shell with an undercut for retention of the grommet in the 10-74900 series clamp. The undercut is notched to prevent grommet slippage. Mounts to panel with four mounting bolts.



Shell Size	Order Number	A Thread	B +.010 -.000	C ±.010	D ±.010	E ±.005	F +.004 -.002
10	10-37090-10X	.5000-28UNEF-2A	.203	.820	.875	.594	.120
12	10-37090-12X	.6250-24NEF-2A	.328	.820	1.000	.719	.120
14	10-37090-14X	.7500-20UNEF-2A	.453	.820	1.094	.812	.120
16	10-37090-16X	.8750-20UNEF-2A	.578	.820	1.188	.906	.120
18	10-37090-18X	1.0000-20UNEF-2A	.676	.820	1.281	.969	.120
20	10-37090-20X	1.1875-18NEF-2A	.801	.850	1.438	1.125	.120
22	10-37090-22X	1.1875-18NEF-2A	.906	.850	1.438	1.125	.120
24	10-37090-24X	1.4375-18NEF-2A	1.016	.875	1.688	1.312	.147
28	10-37090-28X	1.4375-18NEF-2A	1.130	.875	1.688	1.312	.147
32	10-37090-32X	1.7500-18NS-2A	1.438	.875	2.000	1.562	.147
36	10-37090-36X	2.0000-18NS-2A	1.678	1.133	2.250	1.750	.173
40	10-37090-40X	2.2500-16UN-2A	1.914	1.133	2.500	1.938	.173

* To complete order number add shell size and suffix number from finish chart below. For example, shell size 12 with an olive drab chromate finish would be 10-113276-123 or 10-37090-123.

Finish	10-No. Suffix
Chromate treat	-XX1
Olive drab chromate	-XX3

MS/Standard Accessories thru-bulkhead shells

10-113275-XXX*

For Multi-Conductor Cable

One panel hole will provide mounting surface for this shell. Tightening the mounting nut locks the assembly in place and allows room for attachment of the 10-305200 clamp.

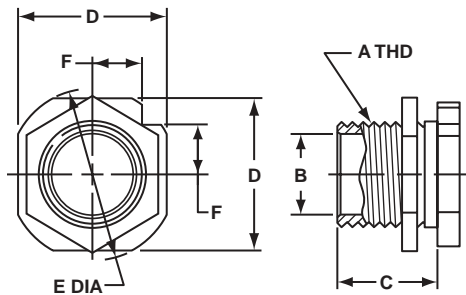

Shell Size	Order Number	A Thread	B ±.010	C ±.005	D ±.010	E ±.010	F ±.010
10	10-113275-10X	.5000-28UNEF-2A	.276	.891	.875	1.031	.309
12	10-113275-12X	.6250-24NEF-2A	.396	.891	1.000	1.156	.354
14	10-113275-14X	.7500-20UNEF-2A	.512	.891	1.125	1.312	.397
16	10-113275-16X	.8750-20UNEF-2A	.636	.959	1.250	1.438	.442
18	10-113275-18X	1.0000-20UNEF-2A	.762	.969	1.375	1.562	.486
20-22	10-113275-20X	1.1875-18NEF-2A	.918	.969	1.688	1.875	.596
24-28	10-113275-24X	1.4375-18NEF-2A	1.167	.969	1.938	2.188	.685
32	10-113275-32X	1.7500-18NS-2A	1.480	1.016	2.250	2.625	.795
36	10-113275-36X	2.0000-18NS-2A	1.730	1.078	2.500	2.875	.884
40	10-113275-40X	2.2500-16UN-2A	1.972	1.141	2.750	3.125	.972

10-37093-XXX*

For Multi-Conductor Cable

Designed to accommodate cable entrance through panel wall or bulkhead and provide attachment for 10-305200 cable clamp. Mounts to panel or wall with four mounting bolts.



Shell Size	Order Number	A Thread	B ±.010	C ±.010	D ±.010	E ±.005	F +.004 -.002
10	10-37093-10X	.5000-28UNEF-2A	.276	.710	.875	.594	.120
12	10-37093-12X	.6250-24NEF-2A	.396	.710	1.000	.719	.120
14	10-37093-14X	.7500-20UNEF-2A	.512	.710	1.094	.812	.120
16	10-37093-16X	.8750-20UNEF-2A	.636	.710	1.188	.906	.120
18	10-37093-18X	1.0000-20UNEF-2A	.762	.710	1.281	.969	.120
20-22	10-37093-20X	1.1875-18NEF-2A	.918	.741	1.438	1.125	.120
24-28	10-37093-24X	1.4375-18NEF-2A	1.167	.766	1.688	1.312	.147
32	10-37093-32X	1.7500-18NS-2A	1.480	.856	2.000	1.562	.147
36	10-37093-36X	2.0000-18NS-2A	1.730	.931	2.250	1.750	.173
40	10-37093-40X	2.2500-16UN-2A	1.972	.931	2.500	1.938	.173

* To complete order number add shell size and suffix number from finish chart below. For example, shell size 12 with an olive drab chromate finish would be 10-113275-123 or 10-37093-123.

Finish	10-No. Suffix
Chromate treat	-XX1
Olive drab chromate	-XX3

Assembly Instructions for 10-305200 & 10-74900 cable clamps

The 10-305200 cable clamp and MS3420A sleeve illustrated are used only on the rear of MS-A or C type connectors. The 10-74900 clamp and grommet assembly can only be used on special feed-thru applications involving dummy shells, part numbers 10-37090 and 10-113276.



ASSEMBLY

Both clamps are shipped from the factory with lubricant conforming to MIL-G-3278. Remove any dirt or foreign material from components with ethyl alcohol and relubricate as outlined under "lubrication." Place the clamping nut (1) on the wire bundle or cable with the threads facing toward the connector or dummy shell. Position the tapered sleeve (2) on the bundle or cable with the narrow portion toward the clamping nut (1). Next install either the gland (3) used with the 10-305200 clamp or thread each wire through the grommet (3) used with the 10-74900 clamp. Dependent on the application, the wire bundle or cable is fed through the dummy shell, or the wire ends are soldered to the connector contacts. Move the components forward in the reverse order of preliminary assembly. (In applications where grommets (3) are used, seat the grommet against the undercut in the back shell before bringing the tapered sleeve (2) up against it). Insure proper positioning of glands (3) or grommets (3), tapered sleeves (2) and clamping nuts (1). Tighten the clamp using a strap wrench until a metal to metal seat is obtained.

MS/Standard Accessories

grommet/sealing plugs

GROMMET 10-408XX-XX*

The Amphenol® grommet provides maximum performance when cables are used which have an O.D. equal to the O.D. specified in MIL-W-5086. For waterproof assembly a cable sheath of neoprene base material is required maintaining the O.D. per MIL-W-5086.



MS Shell Size	Order Number*	A ±.010	B ±.010	C +.010 -.020
8S	10-40808-XX	.312	.250	.406
10S	10-40810-XX	.312	.250	.406
10SL	10-40811-XX	.312	.375	.406
12S	10-40812-XX	.312	.375	.406
12	10-40813-XX	.375	.375	.469
14S	10-40814-XX	.312	.500	.406
14	10-40815-XX	.375	.500	.469
16S	10-40816-XX	.312	.625	.406
16	10-40817-XX	.375	.625	.469
18	10-40818-XX	.438	.750	.532
20	10-40820-XX	.438	.875	.532
22	10-40822-XX	.438	1.000	.532
24	10-40824-XX	.438	1.125	.594
28	10-40828-XX	.438	1.240	.594
32	10-40832-XX	.438	1.531	.657
36	10-40836-XX	.438	1.766	.657
40	10-40840-XX	.438	2.000	.657

* To complete grommet order number add the contact arrangement number desired. (See pages 22 and 23 for available insert arrangements). Example: 10-40810-2 is the order number for the grommet used with 10S-2 insert arrangement.

SEALING PLUG MS27488-XX-1 10-405996-XX1

Sealing plugs are used to fill unused holes in multi-holed grommet configurations.

Order No.	Contact Size	MS Number	Wire Size	Color Code	A Dia. ±.010	B ±.005	C ±.010
10-405996-161	16	27488-16-1	20-16	Blue	.083	.133	.564**
10-405996-121	12	27488-12-1	14-12	Yellow	.121	.171	.564**
10-405996-81	8	27488-8-1	10-8	White	.185	.315	.470
10-405996-41	4	27488-4-1	4-6	Blue	.310	.415	.470
10-405996-01	0	27488-0-1	0-2	Yellow	.440	.605	1.000

**±.020



MS/Standard Accessories

protection caps – plug

PLUG PROTECTION CAP 10-329391-XX*

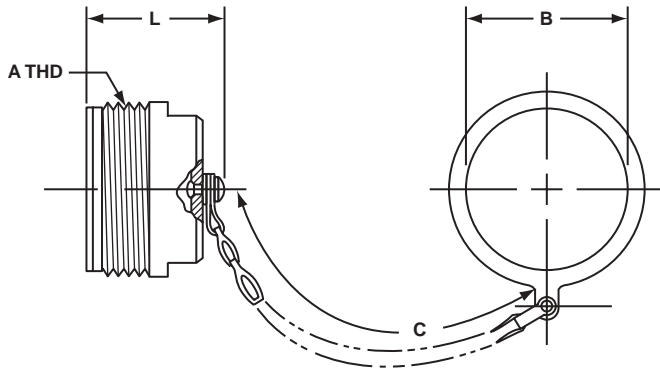

Assembly Number	A Thread Class 2A	B Dia. +.010 - .000	C Approx.	L Max.
10-329391-10	.625-24UNEF	.516	3.5	1.312
10-329391-11	.625-24UNEF	.641	3.5	1.312
10-329391-12	.750-20UNEF	.641	3.5	1.500
10-329391-14	.875-20UNEF	.766	3.5	1.500
10-329391-16	1.000-20UNEF	.891	3.5	1.500
10-329391-18	1.125-18UNEF	1.016	3.5	1.500
10-329391-20	1.250-18UNEF	1.141	4.0	1.500
10-329391-22	1.375-18UNEF	1.266	4.0	1.500
10-329391-24	1.500-18UNEF	1.391	4.5	1.500
10-329391-28	1.750-18UNS	1.641	4.5	1.500
10-329391-32	2.000-18UNS	1.891	5.0	1.500
10-329391-36	2.250-16UN	2.078	5.0	1.500
10-329391-40	2.500-16UN	2.328	5.0	1.500
10-329391-44	2.750-16UN	2.641	6.0	1.500

PLUG PROTECTION CAP 10-229125-XX*

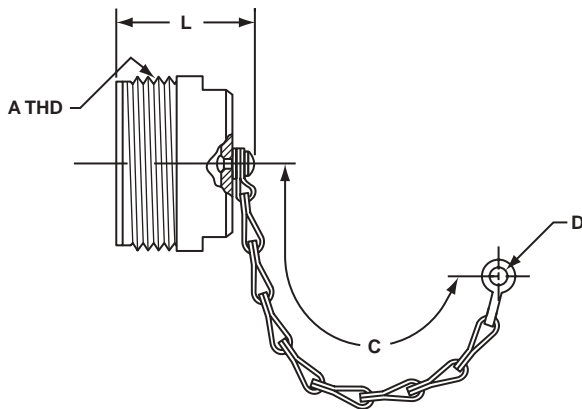

Assembly Number	A Thread Class 2A	C Approx.	D Ref.	L Max.
10-229125-10	.625-24NEF	3.0	.140	1.233
10-229125-12	.750-20UNEF	3.5	.140	1.421
10-229125-14	.875-20UNEF	3.5	.140	1.421
10-229125-16	1.000-20UNEF	3.5	.140	1.421
10-229125-18	1.125-18NEF	3.5	.140	1.421
10-229125-20	1.250-18NEF	3.5	.193	1.421
10-229125-22	1.375-18NEF	3.5	.193	1.421
10-229125-24	1.500-18NEF	4.5	.193	1.421
10-229125-28	1.750-18NS	4.5	.193	1.421
10-229125-32	2.000-18NS	5.0	.193	1.421
10-229125-36	2.250-16UN	5.0	.193	1.421
10-229125-40	2.500-16UN	5.0	.193	1.421

PLUG PROTECTION CAP MS25042-XXDA*

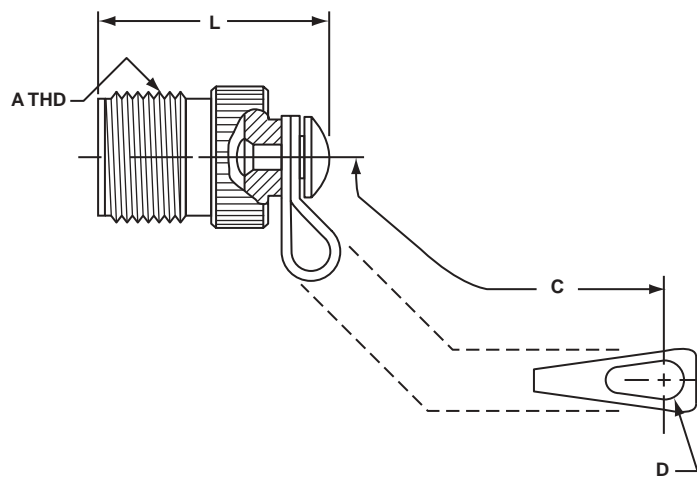

MS Number	A Thread Class 2A	B Dia. +.010 - .005	C Approx.	L Max.
MS25042-8DA	.500-28UNEF	.156	4.00	.969
MS25042-10DA	.625-24UNEF	.156	4.00	.969
MS25042-12DA	.750-20UNEF	.156	4.50	1.156
MS25042-14DA	.875-20UNEF	.156	4.50	1.156
MS25042-16DA	1.000-20UNEF	.156	4.50	1.156
MS25042-18DA	1.125-18UNEF	.156	4.50	1.156
MS25042-20DA	1.250-18UNEF	.187	5.00	1.156
MS25042-22DA	1.375-18UNEF	.187	5.00	1.156
MS25042-24DA	1.500-18UNEF	.187	5.50	1.156
MS25042-28DA	1.750-18UNS	.187	7.75	1.156
MS25042-32DA	2.000-18UNS	.218	7.75	1.156
MS25042-36DA	2.250-16UN	.218	7.75	1.156
MS25042-40DA	2.500-16UN	.218	7.75	1.156

* Protective caps are illustrated with sash chains and are available with beaded chains or without chains. Optional terminations are also available. Consult Amphenol, Sidney, NY when ordering.

MS/Standard Accessories

protection caps – receptacle

RECEPTACLE PROTECTION CAP 10-329392-XX*



Assembly Number	A Thread Class 2B	B Dia. Min.	C Approx.	D Dia. Max.	L Max.
10-329392-10	.625-24UNEF	.516	3.5	.875	.793
10-329392-12	.750-20UNEF	.641	3.5	1.000	.793
10-329392-14	.875-20UNEF	.766	3.5	1.125	.793
10-329392-16	1.000-20UNEF	.891	3.5	1.250	.793
10-329392-18	1.125-18UNEF	1.016	3.5	1.375	1.024
10-329392-20	1.250-18UNEF	1.141	4.0	1.500	1.024
10-329392-22	1.375-18UNEF	1.266	4.0	1.625	1.024
10-329392-24	1.500-18UNEF	1.391	4.5	1.750	1.024
10-329392-28	1.750-18UNS	1.641	4.5	2.000	1.024
10-329392-32	2.000-18UNS	1.891	5.0	2.250	1.024
10-329392-36	2.250-16UN	2.078	5.0	2.500	1.024
10-329392-40	2.500-16UN	2.328	5.0	2.656	1.024
10-329392-44	2.750-16UN	2.641	6.0	2.938	1.024

RECEPTACLE PROTECTION CAP 10-422905-XXX*

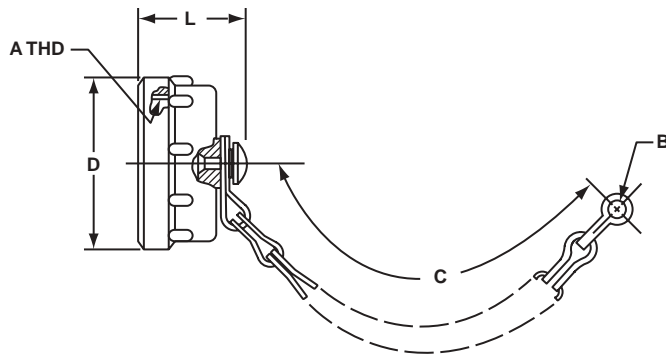

Assembly Number	A Thread Class 2B	B Ref.	C Approx.	D Dia. Max.	L Max.
10-422905-103	.625-24UNEF	.140	3.0	.875	.812
10-422905-123	.750-20UNEF	.140	3.5	1.000	.812
10-422905-143	.875-20UNEF	.140	3.5	1.125	.812
10-422905-163	1.000-20UNEF	.140	3.5	1.250	.812
10-422905-183	1.125-18UNEF	.193	3.5	1.375	1.031
10-422905-203	1.250-18UNEF	.193	4.0	1.500	1.031
10-422905-223	1.375-18UNEF	.193	4.0	1.625	1.031
10-422905-243	1.500-18UNEF	.193	4.5	1.750	1.031
10-422905-283	1.750-18UNS	.193	4.5	2.000	1.031
10-422905-323	2.000-18UNS	.193	5.0	2.250	1.031
10-422905-363	2.250-16UN	.193	5.0	2.500	1.031
10-422905-403	2.500-16UN	.193	5.0	2.656	1.031

RECEPTACLE PROTECTION CAP MS25043-XXDA*



MS Number	A Thread Class 2B	B +.010 - .005	C Approx.	D Dia. Max.	L Max.
MS25043-8DA	.500-28UNEF	.140	4.00	.688	.750
MS25043-10DA	.625-24UNEF	.140	4.00	.815	.750
MS25043-12DA	.750-20UNEF	.140	4.50	1.000	.750
MS25043-14DA	.875-20UNEF	.140	4.50	1.125	.750
MS25043-16DA	1.000-20UNEF	.140	4.50	1.188	.750
MS25043-18DA	1.125-18UNEF	.140	4.50	1.344	.750
MS25043-20DA	1.250-18UNEF	.140	5.00	1.469	.750
MS25043-22DA	1.375-18UNEF	.140	5.00	1.594	.750
MS25043-24DA	1.500-18UNEF	.171	5.50	1.719	.750
MS25043-28DA	1.750-18UNS	.171	7.75	1.969	.812
MS25043-32DA	2.000-18UNS	.187	7.75	2.219	.812
MS25043-36DA	2.250-16UN	.187	7.75	2.469	.812
MS25043-40DA	2.500-16UN	.187	7.75	2.719	.812

* Protective caps are illustrated with sash chains and are available with beaded chains or without chains. Optional terminations are also available. Consult Amphenol, Sidney, NY when ordering.

MS/Standard Accessories

dust caps

10-70500 RECEPTACLE DUST CAP

for external threads



MS Shell Size	Order Number	A Dia. Nominal Thread	C Dia. $\pm.031$	L ¹ $\pm.062$
8S	10-70500-8	.500	.750	.500
10S	10-70500-10	.625	.875	.500
10SL	10-70500-10	.625	.875	.500
12S	10-70500-12	.750	1.000	.500
12	10-70500-12	.750	1.000	.500
14S	10-70500-14	.875	1.125	.500
14	10-70500-14	.875	1.125	.500
16S	10-70500-16	1.000	1.250	.500
16	10-70500-16	1.000	1.250	.500
18	10-70500-18	1.125	1.375	.562
20	10-70500-20	1.250	1.500	.562
22	10-70500-22	1.375	1.625	.562
24	10-70500-24	1.500	1.750	.562
28	10-70500-28	1.750	1.938	.562
32	10-70500-32	2.000	2.250	.562
36	10-70500-36	2.250	2.500	.625
40	10-70500-40	2.500	2.750	.625

10-70506 PLUG DUST CAP

for internal threads



MS Shell Size	Order Number	B Dia. Min.	L ² $\pm.125$
8S	10-70506-8S	.469	.625
10S	10-70506-10S	.587	.625
10SL	10-70506-10S	.587	.625
12S	10-70506-12	.704	.625
12	10-70506-12	.704	.625
14S	10-70506-14	.828	.625
14	10-70506-14	.828	.625
16S	10-70506-16	.953	.625
16	10-70506-16	.953	.625
18	10-70506-18	1.072	.625
20	10-70506-20	1.197	.625
22	10-70506-22	1.322	.625
24	10-70506-24	1.447	.625
28	10-70506-28	1.697	.625
32	10-70506-32	1.947	.625
36	10-70506-36	2.190	.625
40	10-70506-40	2.440	.625

MS/Standard Accessories

10-40450, 10-36675

sealing gaskets



The Amphenol® plain flat gasket of synthetic rubber material is provided to take complete advantage of waterproof and pressure sealing features. It is for use with the flange mounted receptacle.



This flat gasket is provided to give the maximum in connector performance. Its special feature is in providing the maximum radio shielding under difficult conditions of high receiver sensitivity and low signal strength while retaining the sealing characteristics of the plain gasket. This gasket is for use with the flange mounting receptacle.



This gasket is provided for applications where the major requirement is resistance to the injurious effects of extremely low temperature. Even at temperatures as low as -67°F this gasket retains its resiliency and will seal a pressure differential of 30 psi.

MS Shell Size	Installation Dimensions				Order Data		
	A ±.010	B +.016 -.000	C +.016 -.000	D ±.010	Plain	Shielding	Low Temperature
8S	.594	.500	.875	.172	10-40450-8	10-40450-8S	10-36675-8
10S	.719	.625	1.000	.172	10-40450-10	10-40450-10S	10-36675-10
10SL	.719	.625	1.000	.172	10-40450-10	10-40450-10S	10-36675-10
12S	.813	.750	1.094	.172	10-40450-12	10-40450-12S	10-36675-12
12	.813	.750	1.094	.172	10-40450-12	10-40450-12S	10-36675-12
14S	.906	.875	1.188	.172	10-40450-14	10-40450-14S	10-35575-14
14	.906	.875	1.188	.172	10-40450-14	10-40450-14S	10-36675-14
16S	.969	1.000	1.281	.172	10-40450-16	10-40450-16S	10-36675-16
16	.969	1.000	1.281	.172	10-40450-16	10-40450-16S	10-36675-16
18	1.063	1.125	1.375	.203	10-40450-18	10-40450-18S	10-36675-18
20	1.156	1.250	1.500	.203	10-40450-20	10-40450-20S	10-36675-20
22	1.250	1.375	1.625	.203	10-40450-22	10-40450-22S	10-36675-22
24	1.375	1.500	1.750	.203	10-40450-24	10-40450-24S	10-36675-24
28	1.563	1.750	2.000	.203	10-40450-28	10-40450-28S	10-36675-28
32	1.750	2.000	2.250	.219	10-40450-32	10-40450-32S	10-36675-32
36	1.938	2.188	2.500	.219	10-40450-36	10-40450-36S	10-36675-36
40	2.188	2.438	2.750	.219	10-40450-40	10-40450-40S	10-36675-40

All dimensions for reference only.

MS/Standard solder contacts

Machined copper alloy contacts in a full range of sizes, with closed entry socket design in the size 12 and 16 contacts. A heavy silver-plated finish is deposited on all MS style solder contacts for maximum corrosion resistance, maximum current carrying capacity and low millivolt drop.

MS/STANDARD SOLDER CONTACTS*

Part Number	Pin/Socket	Mating End Size	Wire Barrel Size	Allowable Wire Size	Test Current**
10-40569	Pin	16 Short†	16	16	13
10-597107-161	Socket			18	10
				20	7.5
				22	5
10-40599	Pin	16 Long	16	16	13
10-597107-171	Socket			18	10
				20	7.5
				22	5
10-33646	Pin	12	12	12	23
10-597107-131	Socket			14	17
10-35531	Pin	8	8	8	46
10-35532	Socket			10	33
10-35529	Pin	4	4	4	80
10-35530	Socket			6	60
10-35527	Pin	0	0	0	150
10-35528	Socket			1	125
				2	100

* Solder Wells Filled

** Contact ratings as stated are test ratings only. The connector could not withstand full rated current through all contacts continuously. Please note that the electrical data given is not an establishment of electrical safety factors. This is left entirely in the designer's hands as he can best determine which peak voltage, switching surges, transients, etc. can be expected in a particular circuit.

† The 10SL, 12S, 14S and 16S connectors require short contacts.

**TABLE I
CONTACT ARRANGEMENT SERVICE RATING**

MS Service Rating	Recommended Operating Voltage* at Sea Level		Effective Creepage Distance Nom.	Mechanical Spacing Nom.
	DC	AC (RMS)		
Inst.	250	200	1/16	
A	700	500	1/8	1/16
D	1250	900	3/16	1/8
E	1750	1250	1/4	3/16
B	2450	1750	5/16	1/4
C	4200	3000	1	5/16

* The values listed in Table I represent operating values which include a generous safety factor. It may be necessary for some applications to exceed the operating voltages listed here. If this is necessary, designers will find Table II useful for determining the degree to which the recommended values of Table I can be exceeded.

**TABLE II
ALTITUDE VOLTAGE DERATING** CHART**

MS Service Rating	Nominal Distance		Standard Sea Level Conditions		Pressure Altitude† 50,000 Feet		Pressure Altitude† 70,000 Feet	
	Airspace	Creepage	Minimum Flashover Voltage AC (RMS)	Test Voltage AC (RMS)	Minimum Flashover Voltage AC (RMS)	Test Voltage AC (RMS)	Minimum Flashover Voltage AC (RMS)	Test Voltage AC (RMS)
Inst.	1/32	1/16	1400	1000	500	400	325	260
A	1/16	1/8	2800	2000	800	600	450	360
D	1/8	3/16	3600	2800	900	675	500	400
E	3/16	1/4	4500	3500	1000	750	550	440
B	1/4	5/16	5700	4500	1100	825	600	480
C	5/16	1	8500	7000	1300	975	700	560

† Not corrected for changes in density due to variations in temperature.

** No attempt has been made to recommend operating voltages. The designer must determine his own operating voltage by the application of a safety factor to the above derating chart to compensate for circuit transients, surges, etc.

MS/Standard crimp contacts

Machined from copper alloy and silver-plated for maximum corrosion resistance, with a minimum millivolt drop and a maximum current carrying capacity, the size 16 and 12 socket contacts are of the closed entry design. Crimp contacts are available for all MS insert arrangements and are identified with an Amphenol® proprietary number.

MS/STANDARD CRIMP CONTACTS

Part Number	Pin/Socket	Mating End Size	Wire Barrel Size	Allowable Wire Size	Required Wire Adapter Sleeve	Test Current**
10-40553	Pin	16 Short†	16	16	10-74696-6	13
10-40552 or 10-597109-161	Socket			18		10
				20		7.5
				22*		5
10-40557	Pin	16 Long	16	16	10-74696-6	13
10-40556 or 10-597109-171	Socket			18		10
				20		7.5
				22*		5
10-40561	Pin	12	12	12		23
10-40560 or 10-597109-131	Socket			14		17
10-40792	Pin	8	8	8	10-74696-1	46
10-40793	Socket			10*		33
10-40564	Pin	4	4	4	10-74696-2	80
10-40565	Socket			6*		60
10-40562 or 10-581806	Pin	0	0	0		150
10-40563 or 10-581808	Socket			2*		100

* When using wire adapter sleeve shown.

** Contact ratings as stated are test ratings only. The connector could not withstand full rated current through all contacts continuously. Please note that the electrical data given is not an establishment of electrical safety factors. This is left entirely in the designer's hands as he can best determine which peak voltage, switching surges, transients, etc. can be expected in a particular circuit.

† The 10SL, 12S, 14S and 16S connectors require short contacts.

TABLE I

CONTACT ARRANGEMENT SERVICE RATING

MS Service Rating	Recommended Operating Voltage* at Sea Level		Effective Creepage Distance Nom.	Mechanical Spacing Nom.
	DC	AC (RMS)		
Inst.	250	200	1/16	
A	700	500	1/8	1/16
D	1250	900	3/16	1/8
E	1750	1250	1/4	3/16
B	2450	1750	5/16	1/4
C	4200	3000	1	5/16

* The values listed in Table I represent operating values which include a generous safety factor. It may be necessary for some applications to exceed the operating voltages listed here. If this is necessary, designers will find Table II useful for determining the degree to which the recommended values of Table I can be exceeded.

TABLE II

ALTITUDE VOLTAGE DERATING** CHART

MS Service Rating	Nominal Distance		Standard Sea Level Conditions		Pressure Altitude† 50,000 Feet		Pressure Altitude† 70,000 Feet	
	Airspace	Creepage	Minimum Flashover Voltage AC (RMS)	Test Voltage AC (RMS)	Minimum Flashover Voltage AC (RMS)	Test Voltage AC (RMS)	Minimum Flashover Voltage AC (RMS)	Test Voltage AC (RMS)
Inst.	1/32	1/16	1400	1000	500	400	325	260
A	1/16	1/8	2800	2000	800	600	450	360
D	1/8	3/16	3600	2800	900	675	500	400
E	3/16	1/4	4500	3500	1000	750	550	440
B	1/4	5/16	5700	4500	1100	825	600	480
C	5/16	1	8500	7000	1300	975	700	560

† Not corrected for changes in density due to variations in temperature.

** No attempt has been made to recommend operating voltages. The designer must determine his own operating voltage by the application of a safety factor to the above derating chart to compensate for circuit transients, surges, etc.

MS/Standard application tools

When proprietary crimp contacts are employed rather than the standard MS approved solder contacts, the following application tools are recommended for use. There is a possibility of additional crimping tools other than those included being available at present or in the future for this specific application.

Complete instructions for providing reliable crimped wire to contact terminations and inserting proprietary crimp contacts in MS/Standard series connectors are available in publication L-757.

TOOLING CHART

Crimping Tool	Positioner/ Turret	Contact Size	Contact Style	Insertion Tool	Removal Tool
M22520/1-01	*	16	Pin & Socket	11-7345	11-8250 Kit
M22520/1-01	*	12	Pin & Socket	11-7082	11-8250 Kit
**	**	8	Pin & Socket	11-8220	11-8250 Kit
**	**	4	Pin & Socket	11-7365-4†	Pin 11-7370-4† Socket 11-7674-2†
**	**	0	Pin & Socket	11-7365-5†	Pin 11-7370-5† Socket 11-7674-3†

* Use Daniels Turret TH29-1 or Astro Tool Co. Turret 616266.

** For appropriate crimp tool and positioner refer to Pico Crimping Tool Co.

† Tool used with Arbor press 11-7364.

MS/Standard how to order

MIL-DTL-5015 and MIL-5015 Type (Solder Contacts)

MS 3102 A 18-3 P W (SR)
 1 2 3 4 5 6 7 8

1. Connector Type
 MS designates Military Standard
 CS* designates service class A and C with proprietary special contact arrangements
 SG* designates service class E with proprietary special contact arrangements
 SM* designates service class F and R with proprietary special contact arrangements
2. Connector Style
 3100 wall mounting receptacle
 3101 cable connecting plug
 3102 box mounting receptacle
 3106 straight plug
 3108 90° plug
3. Service Class
 A solid shell for general, non-environmental applications
 C solid shell for pressurized applications
 E environmental resisting
 F environmental resisting with strain relief (MS part number only)
 R lightweight environmental resisting
- 4., 5. Shell size and insert arrangement - see tables, pages 22-24.
6. Contact Types
 P designates pin contact
 S designates socket contact
7. Insert Rotation
 "W", "X", "Y", or "Z" designate that insert is rotated in its shell from normal position. No letter required for normal (no rotation) position.
8. (SR) strain relief for non-military connectors (For MS use "F" class)

* For insert arrangements over 50 and shell size 40 and above.
 Exceptions: 36-52, 40-1, 40-9 and 40-56 are MS approved.

Consult Amphenol, Sidney, NY for availability of alternate finishes, including black and olive drab zinc alloys.

Proprietary (Crimp Contacts)

75 - 68 0 12-3 H
 1 2 3 4 5 6

1. Connector Type
 75 – connector utilizing silver plated contacts
 80 – less contacts
 85 – contacts utilizing 50 micro-inches gold over silver plating
2. Service Class
 68 service class A, general duty
 474 service class F, environmental resisting
 190 service class R, lightweight environmental resisting
3. Connector Style
 0 wall mounting receptacle
 1 cable connecting plug
 2 box mounting receptacle
 6 straight plug
 8 90° plug
4. Shell Size Designator

Shell Size	8S	10S	10SL	12S	12	14S	14	16S	16	18
Shell Designator	8	10	11	12	13	14	15	16	17	18

Shell Size	20	22	24	28	32	36	40	44	48	
Shell Designator	20	22	24	28	32	36	40	44	48	

5. Insert Arrangements
 See page 22-24.
6. Contact Type/Alternate Insert Rotation
 P designates pin, S designates socket for normal positioning of inserts. When an alternate position of the connector insert is required to prevent cross-mating, a different letter (other than P or S) is used. See page 25 for description of alternate positions, then convert to Amphenol® proprietary coding by the following charts:

Pin Contacts		Socket Contacts	
MS Letter	Amphenol Letter	MS Letter	Amphenol Letter
PW	G	SW	H
PX	I	SX	J
PY	K	SY	L
PZ	M	SZ	N

Additional MS/Standard Connectors offered by Amphenol

MS/Standard MIL-DTL-5015* Connectors with Crimp Rear Release Contacts

Amphenol broadens their MS/Standard family of connectors with the addition of the Matrix® MIL-DTL-5015 crimp rear release series. This series bridges the gap between the old connector standard and the environmental and high performance needs of current technologies.

Design characteristics of the Amphenol/Matrix 5015 series include:

- MS345() series intermateable with existing MIL-DTL-5015 solder or crimp versions on existing equipment
- Captive coupling nut mechanism, utilizes retaining rings in combination with "L" washers to prevent inadvertent disassembly
- Multiple interlock systems ensure permanent insert retention
- Positive control of dielectric separation with guaranteed ease of contact insertion
- Positive contact retention provided by a closely toleranced damage-proof metal retention clip
- Completely sealed against environmental extremes with individual contact seals, interfacial seals between contacts, peripheral gasket shell-to-shell seals and rear wire seals

Customer Options

- Seven mounting styles, in shell sizes 8 to 48 (consult Amphenol for availability of shell sizes 44 and 48)
- Threaded coupling or self-locking plug (MS3459) with an internal ratcheting mechanism to prevent unmating due to vibration and shock, eliminating the need for safety wiring
- Proprietary quick disconnect plug, with or without lanyard available
- Classes include aluminum or stainless steel shells, or firewall capability
- MS and Proprietary versions available
- Some styles are supplied to McDonnell Douglas Specification BAN 7025, DC60 Series
- Accommodation of contact sizes 0 to 16
- Over 100 insert arrangement patterns available, accommodating from 1 to a maximum of 85 circuits
- Alternate positioning available; thermocouple contacts available

Ask for Amphenol catalog 12-026 for detailed information.

MIL-5015 Modifications

In order to supplement standard MS shell styles and provide a greater variety of styles for the electrical connector user, there are several MS and MS Modified cylindrical connectors offered by Amphenol. These types include flange mount plugs, thru bulkhead receptacles, jam nut receptacles, connectors for potting and connectors designed specifically to terminate jacketed cable.

Ask for Amphenol catalog 12-021 for detailed information.

97 Series, MIL-5015 Type Connectors

The low cost, general duty connector used extensively in the machine tool industry, welding industry and numerous other industrial applications, is the Amphenol® 97 Series. Offered in non-environmental styles, these connectors have hard dielectric inserts and threaded coupling. They are Underwriters Laboratories Recognized and Canadian Standards Association Certified.

Ask for Amphenol catalog 12-022 for detailed information.

Pre-Earth FMLB Connectors

Designed for applications where a protective circuit from the ground contact to the shell is a safety requirement, Pre-earth connectors use MIL-5015 type shells, inserts and arrangements. They have first mate, last break capability; when mated this feature protects operators and sensitive circuits.

Ask for Product Data Sheet PDS 187 for detailed information.



Amphenol®/Matrix® MS/Standard MIL-C-5015 Connectors with Crimp Rear Release Contacts



97 Series, MIL-C-5015 Type Connectors

* Note: MIL-DTL-5015 supercedes MIL-C-5015 for all Amphenol/Matrix rear release crimp type connectors.

Additional MS/Standard Connectors offered by Amphenol, cont.

Amphe-Power™ 5015 Connectors

Amphenol offers the AC threaded series derived from the MIL-5015 family that can be enhanced with high amperage RADSOK® contacts.

Design characteristics of the Amphe-Power 5015 connectors are:

- The RADSOK contact handles up to 150% higher amperages than standard contacts
- The RADSOK contact has a twisted hyperbolic, stamped grid configuration within the socket. This design ensures a large, coaxial, face-to-face surface area engagement. As male pin is inserted, axial members in the female half deflect, imparting high current flow across the connection with minimal voltage loss.
- Contact arrangements have RADSOK sockets in sizes 0, 4 and 8 with standard contacts in sizes 16 and 12.

The contacts available in RADSOK and the amperages are as follows:

- Size 8 AWG can handle currents up to 69 amps.
- Size 4 AWG can handle currents up to 120 amps.
- Size 0 AWG can handle currents up to 250 amps.

(For availability of size 12 RADSOK that handles currents up to 35 amps, consult Amphenol.)

- AC threaded 5015 styles include: solid shell for general, non-environmental applications; pressurized style for use on pressurized bulkheads or pressure barriers; environmental resisting style with strain relief; lighter weight and shorter environmental resisting style

For more information ask for Amphenol brochure SL-391, Amphe-Power Connectors with RADSOK technology.



**Amphe-Power® 5015 Connectors
(AC Threaded 5015 type connectors with RADSOK® high amperage contacts)**



The RADSOK design - socket cylinder within female contact has twisted hyperbolic grid. Provides higher amperage capabilities with low insertion force and low temperature rise.

MIL-5015 Connectors with PCB Contacts

Box mount receptacle MIL-5015 type connectors can be supplied with PCB tails for mounting to a printed circuit board.

See catalog 12-170, Amphenol Cylindrical Connectors for Printed Circuit Board Applications. This catalog gives the most commonly available and widely used insert patterns for cylindrical connectors with PCB tails, along with pin-out location diagrams.



Компания «Life Electronics» занимается поставками электронных компонентов импортного и отечественного производства от производителей и со складов крупных дистрибьюторов Европы, Америки и Азии.

С конца 2013 года компания активно расширяет линейку поставок компонентов по направлению коаксиальный кабель, кварцевые генераторы и конденсаторы (керамические, пленочные, электролитические), за счёт заключения дистрибьюторских договоров

Мы предлагаем:

- Конкуренспособные цены и скидки постоянным клиентам.
- Специальные условия для постоянных клиентов.
- Подбор аналогов.
- Поставку компонентов в любых объемах, удовлетворяющих вашим потребностям.
- Приемлемые сроки поставки, возможна ускоренная поставка.
- Доставку товара в любую точку России и стран СНГ.
- Комплексную поставку.
- Работу по проектам и поставку образцов.
- Формирование склада под заказчика.
- Сертификаты соответствия на поставляемую продукцию (по желанию клиента).
- Тестирование поставляемой продукции.
- Поставку компонентов, требующих военную и космическую приемку.
- Входной контроль качества.
- Наличие сертификата ISO.

В составе нашей компании организован Конструкторский отдел, призванный помогать разработчикам, и инженерам.

Конструкторский отдел помогает осуществить:

- Регистрацию проекта у производителя компонентов.
- Техническую поддержку проекта.
- Защиту от снятия компонента с производства.
- Оценку стоимости проекта по компонентам.
- Изготовление тестовой платы монтаж и пусконаладочные работы.



Тел: +7 (812) 336 43 04 (многоканальный)

Email: org@lifeelectronics.ru