

## One Cell Li-ion/Li-polymer Linear Charger IC with Battery Temperature Detection

### ■ GENERAL DESCRIPTION

The XC6803 is a Constant-Voltage (CV) and Constant-Current (CC) type charging IC for linear charging of single-cell Li-ion batteries and Li-polymer batteries. The basic charging cycle consists of trickle charge mode followed by main charge mode. This IC supports temperature control based on JEITA, making it possible to safely charge Li-ion batteries and Li-polymer batteries by controlling the CV charge voltage and CC charge current according to the temperature. By connecting a resistor to the charge status output pin, it is possible to check the charge condition via the charge status output (CSO) pin voltage. The IC is housed in the small USP-6EL package with high heat dissipation, and a charge circuit can be configured using a minimum of external components.

### ■ APPLICATIONS

- Wearable Device
- Fitness Tracker
- MP3 Player, Portable Audio Player
- IC recorder
- Bluetooth Headset
- GPS Watch, Smart Watch

### ■ FEATURES

JEITA conforming Thermistor Detect Function Built-in	
Operating Voltage Range	: 4.5V ~ 6V
Supply Current	: TYP. 100 $\mu$ A
CC Charge Current	: 40mA ~ 280mA Can be set by external resistance
CV Charge Voltage	: 4.2V, 4.05V (at high temperature) Internally fixed
Protection Circuit	: Thermistor detection function Safety timer function UVLO (Under Voltage Lock Out) Thermal shutdown Dropout voltage monitor function Charging over-voltage monitor function Charging over-current monitor function Recharge function (XC6803xxE)
Operating Ambient Temperature	: -40°C ~ +85°C
Package	: USP-6EL
Environmentally Friendly	: EU RoHS Compliant, Pb Free

### ■ TYPICAL APPLICATION CIRCUIT

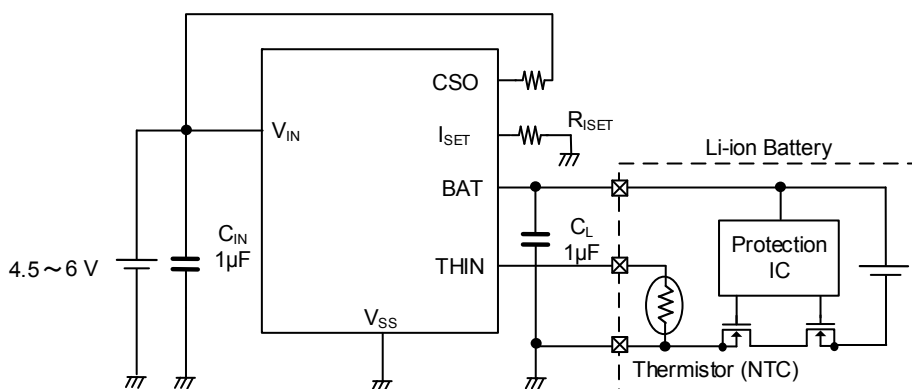

# XC6803 Series

## ■ BLOCK DIAGRAM

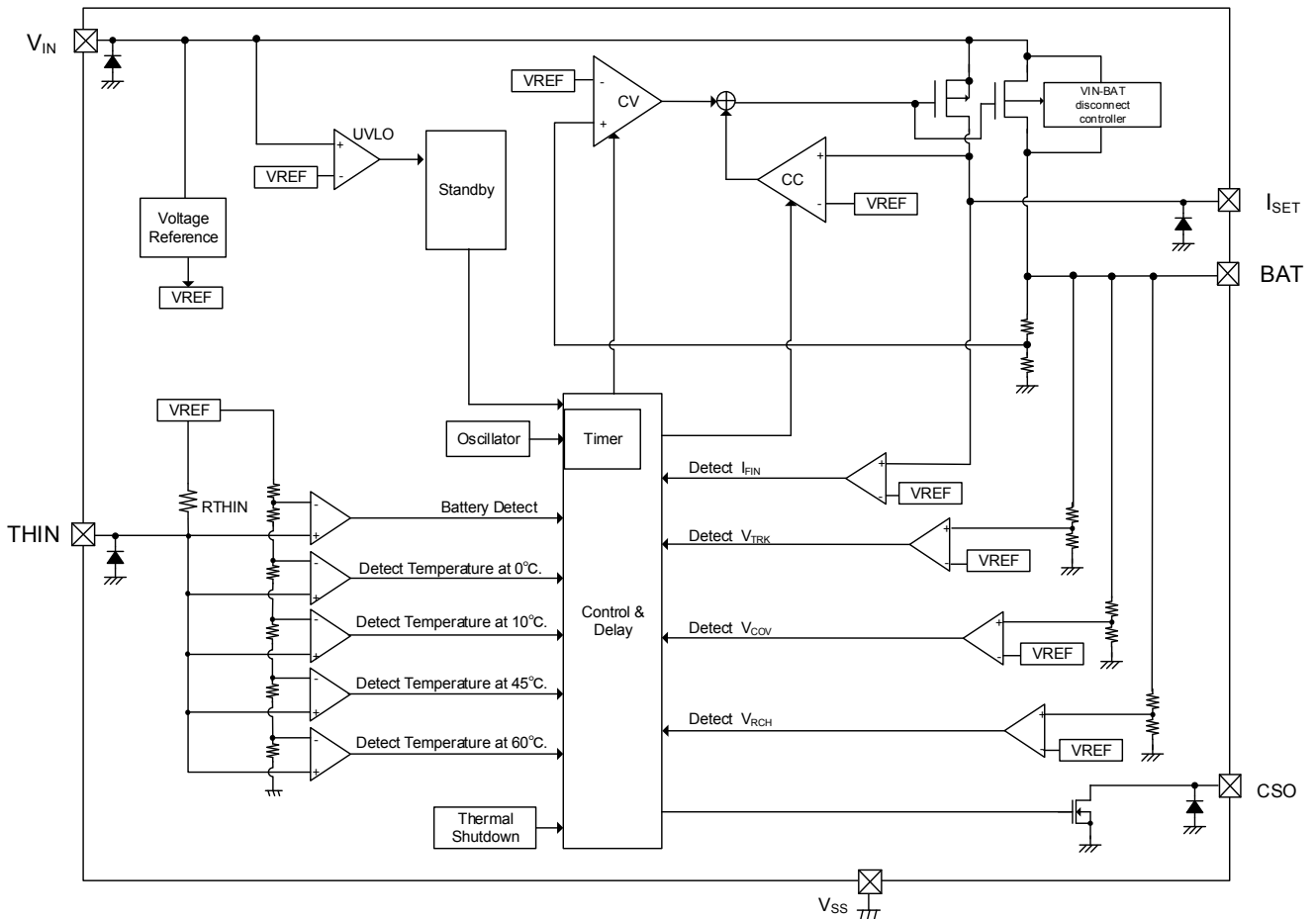

## ■ PRODUCT CLASSIFICATION

XC6803①②③④⑤⑥⑦<sup>(\*)</sup>

DESIGNATOR	DESCRIPTION	SYMBOL	DESCRIPTION
①	Charge Status Output on Abnormal Mode	A	1kHz ON-OFF
		B	OFF
②	Battery Temperature Monitor Function	2	2 Temperature Monitor
		3	3 Temperature Monitor
		4	4 Temperature Monitor
③	Recharge Function	E	Enable
		D	Disable
④	CV Charge Voltage	1	4.2V (Fixed)
⑤⑥⑦ <sup>(*)</sup>	Package (Order Unit)	4R-G	USP-6EL (3,000pcs/Reel)

<sup>(\*)</sup> The "G" suffix indicates that the products are Halogen and Antimony free as well as being fully EU RoHS compliant.

## ■ PIN CONFIGURATION

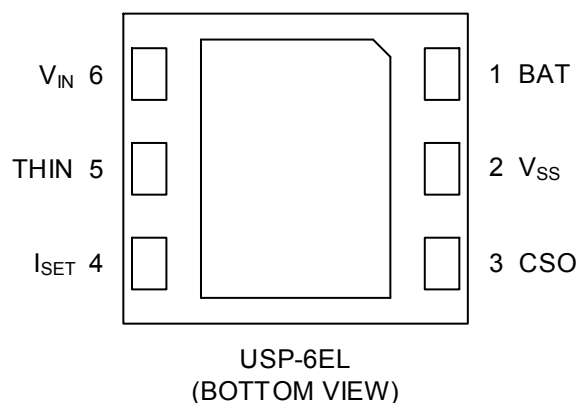

\*The dissipation pad should be solder-plated in recommended mount pattern and metal masking so as to enhance mounting strength and heat release.

When taking out a potential of the heat-sink, connect with  $V_{SS}$  pin (#2 pin).

## ■ PIN ASSIGNMENT

PIN NUMBER	PIN NAME	FUNCTION
USP-6EL		
1	BAT	Charge Current Output
2	$V_{SS}$	Ground
3	CSO	Charge Status Output
4	$I_{SET}$	Charge Current Setup
5	THIN	Temperature Detection
6	$V_{IN}$	Power Supply Input
Back Metal		Internally Connected $V_{SS}$

## ■ ABSOLUTE MAXIMUM RATINGS

$T_a = 25\text{ }^\circ\text{C}$

PARAMETER	SYMBOL	RATING	UNIT
$V_{IN}$ Pin Voltage	$V_{IN}$	-0.3 ~ +6.5	V
BAT Pin Voltage	$V_{BAT}$	-0.3 ~ +6.5	V
CSO Pin Voltage	$V_{CSO}$	-0.3 ~ +6.5	V
THIN Pin Voltage	$V_{THIN}$	-0.3 ~ $V_{IN} + 0.3$ or +6.5 <sup>(*)</sup>	V
$I_{SET}$ Pin Voltage	$V_{ISET}$	-0.3 ~ $V_{IN} + 0.3$ or +6.5 <sup>(*)</sup>	V
BAT Pin Current	$I_{BAT}$	1000	mA
Power Dissipation	USP-6EL	Pd	120
			750 (PCB mounted)
Operating Ambient Temperature	$T_{opr}$	-40 ~ +85	$^\circ\text{C}$
Storage Temperature	$T_{stg}$	-55 ~ +125	$^\circ\text{C}$

Each rating voltage is based on the  $V_{SS}$ .

<sup>(\*)</sup> Either of lower one,  $V_{IN} + 0.3$  or +6.5, is applicable.

## ELECTRICAL CHARACTERISTICS

Unless otherwise stated,  $V_{IN}=5.0V$ ,  $V_{THIN}=1.0V$ ,  $R_{ISET}=100k\Omega$ ,  $C_{IN}=C_L=1\mu F$ ,  $T_a=25^\circ C$

PARAMETER	SYMBOL	CONDITION	MIN.	TYP.	MAX.	UNIT	CIRCUIT
Operating Voltage Range	$V_{IN}$		4.5	5	6	V	-
Supply Current <sup>(*)</sup>	$I_{SS}$	$V_{BAT}=3.5V$	-	100	-	$\mu A$	-
Standby Current	$I_{STB}$	$V_{BAT}=4.3V$ , $I_{STB}=I_{IN} - I_{THIN}$	-	60	-	$\mu A$	①
$V_{IN} - V_{BAT}$ Shut-down Voltage	$V_{IBSD}$	$V_{BAT}=4.1V$	-	$V_{BAT}+40$	-	mV	②
Shut-down Hysteresis Voltage <sup>(*)</sup>	$V_{IBSDHYS}$			60		mV	②
UVLO Voltage	$V_{UVLO}$		3.6	3.8	4	V	②
UVLO Hysteresis Voltage <sup>(*)</sup>	$V_{UVLOHYS}$		-	200	-	mV	②
Trickle Charge Voltage	$V_{TRK}$		2.8	2.9	3	V	②
Trickle Charge Hysteresis Voltage <sup>(*)</sup>	$V_{TRKHYS}$		-	100	-	mV	②
Trickle Charge Current (Min.) <sup>(*)</sup>	$I_{TRKI}$	$R_{ISET}=100k\Omega$ , $V_{BAT}=2.4V$	-	4	-	mA	②
Trickle Charge Current	$I_{TRK}$	$R_{ISET}=20k\Omega$ , $V_{BAT}=2.4V$	13	16	20	mA	②
Trickle Charge Current (Max.) <sup>(*)</sup>	$I_{TRKA}$	$R_{ISET}=11k\Omega$ , $V_{BAT}=2.4V$	-	28	-	mA	②
CV Charge Voltage	$V_{BAC}$	$I_{BAT}=20mA$	4.17	4.2	4.23	V	③
		$I_{BAT}=20mA$ $V_{THIN}=V_{THIN\_open} \times V_{T45}^{(*)}$	4.02	4.05	4.08	V	③
CC Charge Current (Min.) <sup>(*)</sup>	$I_{BACI}$	$R_{ISET}=100k\Omega$ , $V_{BAT}=3.1V$	-	40	-	mA	②
		$R_{ISET}=100k\Omega$ , $V_{BAT}=3.1V$ $V_{THIN}=V_{THIN\_open} \times V_{T10}^{(*)}$	-	19.1	-	mA	②
CC Charge Current	$I_{BAC}$	$R_{ISET}=20k\Omega$ , $V_{BAT}=3.1V$	150	166	188	mA	②
		$R_{ISET}=20k\Omega$ , $V_{BAT}=3.1V$ $V_{THIN}=V_{THIN\_open} \times V_{T10}^{(*)}$	66	78	93	mA	②
CC Charge Current (Max.) <sup>(*)</sup>	$I_{BACA}$	$R_{ISET}=11k\Omega$ , $V_{BAT}=3.1V$	-	280	-	mA	②
		$R_{ISET}=11k\Omega$ , $V_{BAT}=3.1V$ $V_{THIN}=V_{THIN\_open} \times V_{T10}^{(*)}$	-	131	-	mA	②
Charge Completion Current (Min) <sup>(*)</sup>	$I_{FINI}$	$R_{ISET}=100k\Omega$	-	4.4	-	mA	③
Charge Completion Current	$I_{FIN}$	$R_{ISET}=20k\Omega$	12	20	30	mA	③
Charge Completion Current (Max) <sup>(*)</sup>	$I_{FINA}$	$R_{ISET}=11k\Omega$	-	32	-	mA	③
Over Voltage Protection Threshold	$V_{COV}$		4.3	4.45	4.6	V	②
Over Current Protection Threshold	$I_{COP}$	$R_{ISET}=3k\Omega$	-	600	-	mA	③
Driver ON Resistance	$R_{ON}$	$V_{IN}=4.1V$ , $R_{ISET}=11k\Omega$ $I_{BAT}=200mA$	-	350	550	m $\Omega$	③
Driver Leakage Current	$I_{LEAK}$	$V_{IN}=6.0V$ , $V_{BAT}=0V$	-	-	1	$\mu A$	⑤
BAT Pin Reverse Current	$I_{REV}$	$V_{BAT}=4.5V$ , $V_{IN}=0V$	-	0.5	1.4-	$\mu A$	⑥
BAT Pin Pull-down Current	$I_{BATPD}$	$V_{BAT}=4.3V$	-	3	-	$\mu A$	②
Recharge Voltage (XC6803xxE)	$V_{RCHG}$		3.7	3.9	4.1	V	②
		$V_{THIN}=V_{THIN\_open} \times V_{T45}^{(*)}$	3.55	3.75	3.95	V	②

(\*) Design target

(\*) Applicable only to XC6803x4

(\*) Applicable only to XC6803x3 and XC6803x4

## ■ ELECTRICAL CHARACTERISTICS (Continued)

Unless otherwise stated,  $V_{IN}=5.0V$ ,  $V_{THIN}=1.0V$ ,  $R_{ISET}=100k\Omega$ ,  $C_{IN}=C_L=1\mu F$ ,  $T_a=25\text{ }^\circ\text{C}$

PARAMETER	SYMBOL	CONDITION	MIN.	TYP.	MAX.	UNIT	CIRCUIT
THIN Pin Open Voltage	$V_{THIN\_open}$		1.94	2.0	2.06	V	⑤
Battery Connect Detection	$V_{TD}$		77	80	83	% <sup>(2)</sup>	②
Battery Connect Detection Hysteresis <sup>(1)</sup>	$V_{TDH}$	At temperature fall	-	3	-	% <sup>(2)</sup>	②
Thermistor Detection at 0°C	$V_{T0}$		71.13	73.13	75.13	% <sup>(2)</sup>	②
Thermistor Detection Hysteresis at 0°C <sup>(1)</sup>	$V_{T0H}$	At temperature rise	-	2.18	-	% <sup>(2)</sup>	②
Thermistor Detection at 10°C <sup>(3)</sup>	$V_{T10}$		62.19	64.19	66.19	% <sup>(2)</sup>	②
Thermistor Detection Hysteresis at 10°C <sup>(1)(3)</sup>	$V_{T10H}$	At temperature rise	-	2.38	-	% <sup>(2)</sup>	②
Thermistor Detection at 45°C	$V_{T45}$		30.96	32.96	34.96	% <sup>(2)</sup>	②
Thermistor Detection Hysteresis at 45°C <sup>(1)</sup>	$V_{T45H}$	At temperature fall	-	1.94	-	% <sup>(2)</sup>	②
Thermistor Detection at 60°C <sup>(4)</sup>	$V_{T60}$		21.16	23.16	25.16	% <sup>(2)</sup>	②
Thermistor Detection Hysteresis at 60°C <sup>(1)(4)</sup>	$V_{T60H}$	At temperature fall	-	1.47	-	% <sup>(2)</sup>	②
THIN Pin Connected Resistance	$R_{THIN}$	$V_{THIN}=0V$	9.8	10	10.2	k $\Omega$	①
Trickle Charge Hold Time	$t_{TRK}$		-	0.5	-	hr	②
Main Charge Hold Time	$t_{CHG}$		-	5	-	hr	②
CSO Pin OFF Current	$I_{CSO\_OFF}$	$V_{CSO}=6.0V$	-	-	1	$\mu A$	⑦
CSO Pin ON Voltage	$V_{CSO}$	$I_{CSO}=10mA$	-	-	0.5	V	④
Thermal Shut-Down Detection Temperature <sup>(1)</sup>	$T_{TSD}$		-	140	-	$^\circ\text{C}$	②
CSO Frequency (XC6803A)	$f_{CSO}$		0.75	1	1.25	kHz	②

<sup>(1)</sup> Design target

<sup>(2)</sup> The comparator detect voltage and hysteresis width are indicated as percentages of the THIN pin open voltage,  $V_{THIN\_open}$ , (taken to be 100%).

$$V_{Txx} = V_{Txx'} / V_{THIN\_open}$$

( $V_{Txx'}$  : Voltage when the external voltage applied to the THIN pin sweeps and the IC internal comparator inverts)

<sup>(3)</sup> Applicable only to XC6803x3 and XC6803x4

<sup>(4)</sup> Applicable only to XC6803x4

## TEST CIRCUITS

1) Test Circuit ①

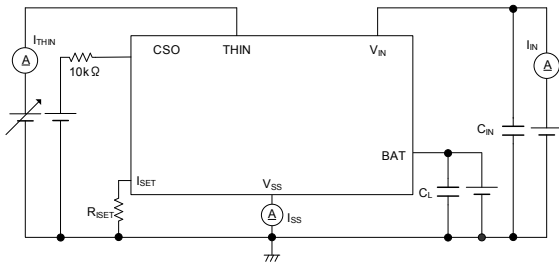

2) Test Circuit ②

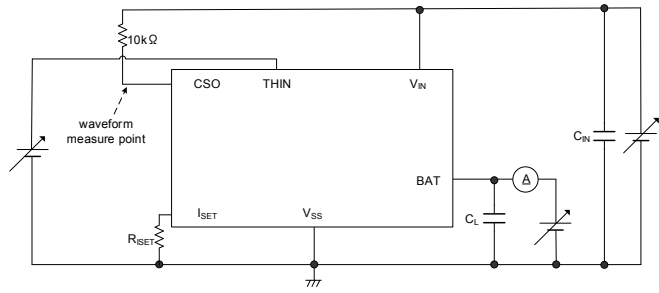

3) Test Circuit ③

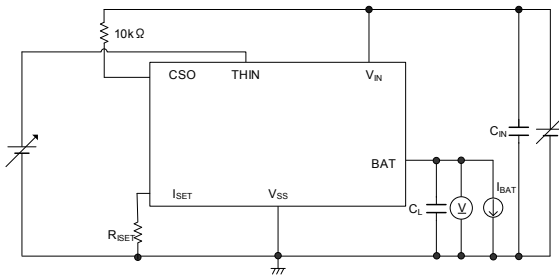

4) Test Circuit ④

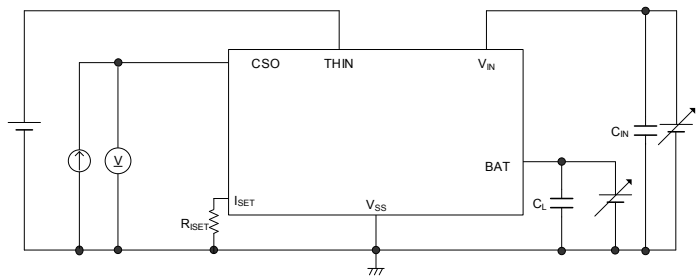

5) Test Circuit ⑤

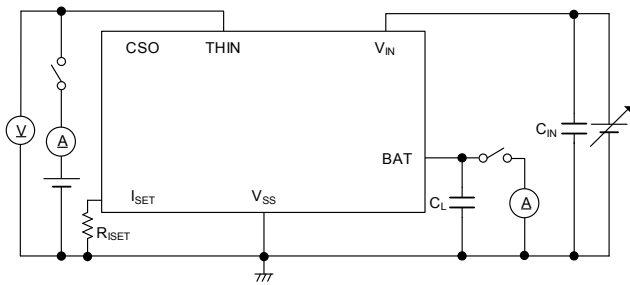

6) Test Circuit ⑥

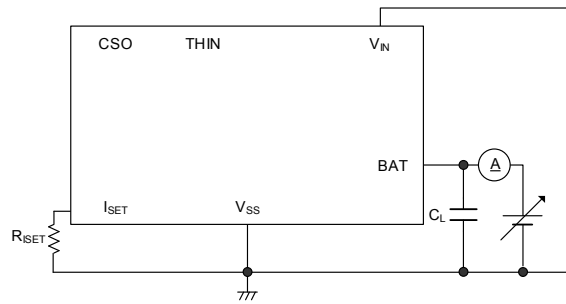

7) Test Circuit ⑦

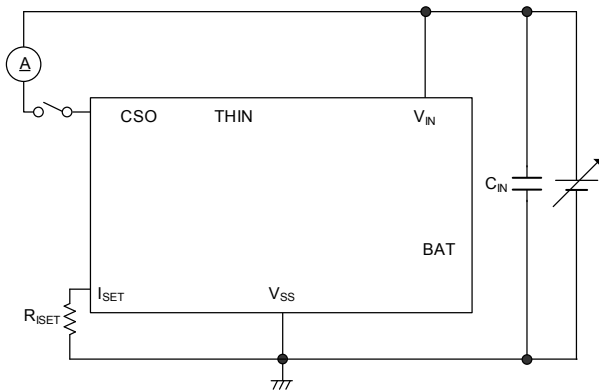

## ■ TYPICAL APPLICATION CIRCUIT

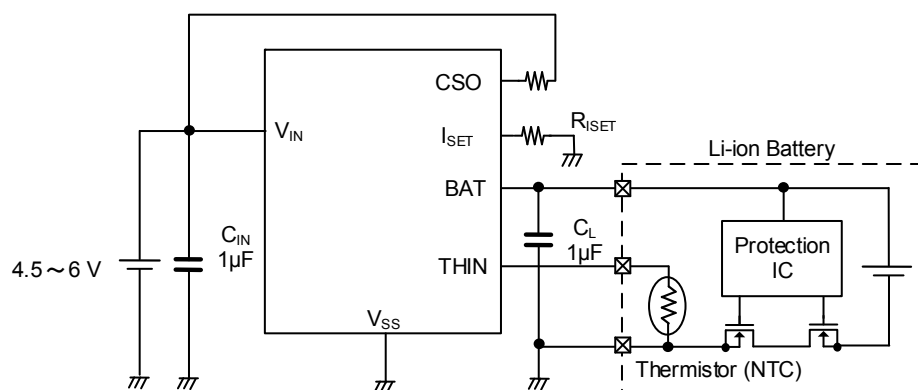

### 【Recommended Parts】

	MANUFACTURE	PRODUCT NUMBER	VALUE
$C_{IN}$	TAIYO YUDEN	LMK107BJ105KA	1 $\mu$ F / 10V
$C_L$	TAIYO YUDEN	LMK107BJ105KA	1 $\mu$ F / 10V
NTC	Murata	NCP15XH103F03RC	Resistance: 10k $\Omega$ @ 25°C B-constant (25 ~ 50°C): 3380K
$R_{ISET}$			11 ~ 100k $\Omega$

## OPERATIONAL EXPLANATION

### ● Charge Function

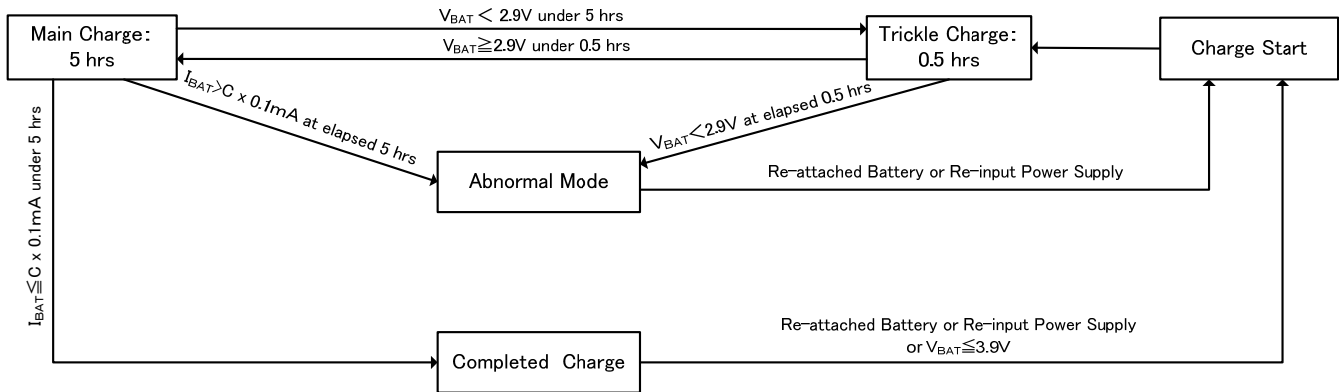

#### Charging start

When a thermistor is connected to the THIN pin after a voltage is applied to the power input pin (①), or when a voltage is applied to the power input pin after a thermistor is connected to the THIN pin (②), the power on reset function activates and initializes the internal counter. After 200 ms elapse in the case of ①, or 150 ms in the case of ②, charging starts.

#### Trickle charging: Less than 0.5 hour

Trickle charging determines if main charging of the Li-ion battery is possible. The Li-ion battery is charged at a trickle charge current that is one-tenth the charge current set with the external resistor R<sub>ISET</sub>. If the BAT pin voltage V<sub>BAT</sub> is above 2.9 V in the charging start state, trickle charging takes place for 1ms and then main charging begins. If V<sub>BAT</sub> is less than 2.9 V, trickle charging takes place, and main charging begins 50ms after 2.9 V is reached. If the BAT pin voltage is less than 2.9 V after 0.5 hours, the IC changes to the error state and stops charging the Li ion battery. In addition, the error in the trickle charge current increases if V<sub>BAT</sub> drops below about 1V.

#### Main charging: Less than 5 hours

When the condition for transition from trickle charging is satisfied, it is determined that rapid charging of the Li-ion battery is possible and the IC changes to the main charging state. In main charging, the IC charges an Li-ion battery at a CC charge current that is set with the external resistor R<sub>ISET</sub>. If the BAT pin voltage V<sub>BAT</sub> rises to the CV charge voltage V<sub>BAC</sub> within 5 hours, the charge current drops to the charge completed current, and after 50 ms elapse, the state changes to charge completed and charging stops. If the charge current is higher than the charging completed current after 5 hours, the IC changes to the error state and stops charging.

#### Charging completed

When 50 ms elapse after the charge current drops from the main charging state to the charge completed current, which is one-tenth the charge current set with the external resistance R<sub>ISET</sub>, the state changes to charge completed and charging of the Li ion battery stops. At this time, the charge status output pin changes from ON to OFF. On the XC6803xxE, when the BAT pin voltage (V<sub>BAT</sub>) falls from the charge completion state to the recharge voltage (V<sub>RCHG</sub>) or less, charging automatically restarts. When a voltage is reapplied to the power input pin or a Li-ion battery is reconnected to the BAT pin, the IC starts up and charging begins.

#### Error state

If it is determined that charging is abnormal in any state, the IC treats this as an error state and stops charging. When the power is turned off and then on, or the battery is reinserted, the IC starts up again and charging starts. An error state occurs if 0.5 hours elapse during trickle charging, if 5 hours elapse during main charging, or if thermal shutdown, charging over-voltage, or charging over-current is detected.

### ● Charging status output pin CSO

The charge status output pin is ON during trickle charging and main charging with Nch open drain output, and turns OFF when charging is completed. A LED can be connected to allow confirmation of charging by illumination of the LED. When an error state is detected, the charge status output pin repeats ON-OFF at 1kHz on the XC6803A and turns OFF on the XC6803B. An error state indicates a state in which 0.5 hours have elapsed during trickle charging, 5 hours have elapsed during main charging, the thermal shutdown or charging over-voltage or charging over-current is detected.

### ● Charge current

The charge current I<sub>BAT</sub> of this IC can be set within the range 40mA to 280mA with the external resistance R<sub>ISET</sub>. The relation between R<sub>ISET</sub> and I<sub>BAT</sub> is approximated by the equation below.

$$R_{\text{ISET}} \text{ (k}\Omega\text{)} = 6620 \times I_{\text{BAT}}^{-1.136} \text{ (mA)}$$

(\*) The XC6803xxD does not have a recharge function.



## ■ OPERATIONAL EXPLANATION (Continued)

### ● IC temperature monitoring function

In order to prevent destruction due to IC heat generation as well as abnormal charging due to thermal runaway, a thermal shutdown circuit is incorporated into the IC. If the chip temperature rises to 140°C or higher and after 50ms elapses, the output driver is turned off and charging is stopped. At this time, the charge status output pin repeats ON-OFF at 1kHz on the XC6803A, and turns off on the XC6803B. When voltage is reapplied to the power input pin or the Li-ion battery is reconnected to the BAT pin, the IC starts up and charging begins.

### ● Dropout voltage monitoring function

To prevent reverse current from the Li-ion battery to the battery charger, this function monitors the dropout voltage between the BAT pin voltage ( $V_{BAT}$ ) and power input pin voltage ( $V_{IN}$ ). When  $V_{IN}$  drops to  $V_{BAT} + 40\text{mV}$ , the output driver turns OFF and the driver backgate connection is changed from the power input pin to the BAT pin. After 50ms elapse, the charge status output pin repeats ON-OFF at 1kHz on the XC6803A and turns off on the XC6803B. After charging is completed, the charge status output pin maintains the OFF state even if this function is activated by disconnection of the input power or otherwise. When  $V_{IN}$  rises higher than  $V_{BAT} + 0.1\text{V}$ , the function is released, the output driver turns ON, the driver backgate connects to the power pin and resumes charging, and the charge status output pin turns ON. The  $t_{TRK}$  count and  $t_{CHG}$  count continue even while charging is stopped.

### ● UVLO function

A UVLO function is incorporated. If the power input voltage,  $V_{in}$  falls to 3.8V or lower during charging, this function turns off the output driver and stops charging. In addition, charge status output pin changes to off. When the  $V_{in}$  rises to 4V or higher, the IC starts up and charging begins. This function also detects voltage application to the power input pin.

### ● Charge over-voltage monitoring function

To prevent charging of a battery in the over-voltage state, charging is stopped after 50ms when the BAT pin voltage rises to 4.45V or higher. At this time, the charge status output pin repeats ON-OFF at 1kHz on the XC6803A, and turns off on the XC6803B. When voltage is reapplied to the power input pin or the Li ion battery is reconnected to the BAT pin, the IC starts up and charging begins.

### ● Charge over-current monitoring function

To prevent charging of a battery by excessive current, this function stops charging if the charge current rises to 600mA or higher. At this time, the charge status output pin repeats ON-OFF at 1kHz on the XC6803A, and turns off on the XC6803B. When voltage is reapplied to the power input pin or the Li ion battery is reconnected to the BAT pin, the IC starts up and charging begins.

### ● Recharge function

If the NTC thermistor temperature is 0°C to under 45°C in the charging completed state and 50ms elapse after the BAT pin voltage  $V_{BAT}$  drops to 3.9V or less, the IC enters the charging start state (charging resumes 150ms after the charging start state). On the XC6803x4, charging automatically resumes if  $V_{BAT}$  drops below 3.75V when the NTC thermistor temperature is over 45°C and less than 60°C. This function only operates on the XC6803xxE, not on the XC6803xxD.

## OPERATIONAL EXPLANATION (Continued)

### ● Li-ion battery temperature monitoring function

The IC monitors the Li-ion battery temperature during charging by means of the NTC thermistor (“thermistor” below) connected to the THIN pin, and controls the charge voltage  $V_{BAC}$  and charge current  $I_{BAT}$  according to the Li-ion battery temperature as shown below to charge safely. The charge state changes 50ms after the Li-ion battery temperature reaches each of the change points.

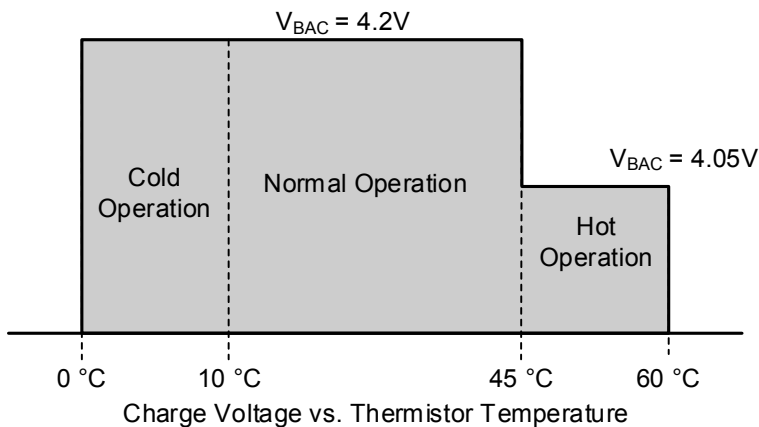
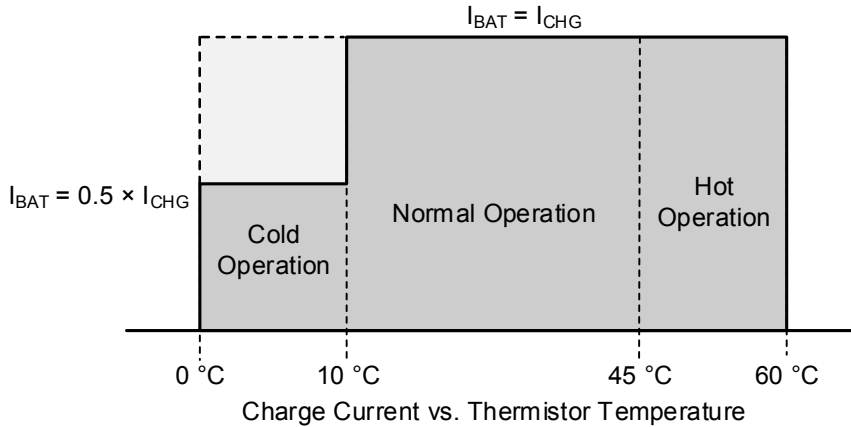

### ●XC6803x4 (4 Temperature monitoring)

#### Cold Operation

When  $0^\circ\text{C} < \text{Thermistor Temperature} \leq 10^\circ\text{C}$ , the charge current is limited to  $I_{CHG} \times 0.5$ .<sup>(1)</sup>

When Thermistor Temperature  $\leq 0^\circ\text{C}$ , charging is stopped.<sup>(2)</sup>

#### Normal Operation

When  $10^\circ\text{C} < \text{Thermistor Temperature} < 45^\circ\text{C}$ , charging takes place with the charging current at  $I_{CHG}$  and the charging voltage at 4.2V.<sup>(1)</sup>

#### Hot Operation

When  $45^\circ\text{C} \leq \text{Thermistor Temperature} < 60^\circ\text{C}$ , charging takes place with the charging voltage at 4.05V.<sup>(1)</sup>

When  $60^\circ\text{C} \leq \text{Thermistor Temperature}$ , charging is stopped.<sup>(2)</sup>

### ●XC6803x3 (3-temperature monitoring)

Instead of the  $60^\circ\text{C}$  monitoring of the XC6803x4, the XC6803x3 stops charging when  $45^\circ\text{C} \leq \text{Thermistor Temperature}$ .<sup>(2)</sup>

### ●XC6803x2 (2-temperature monitoring)

Instead of the  $10^\circ\text{C}$  and  $60^\circ\text{C}$  monitoring of the XC6803x4, the XC6803x2 stops charging when Thermistor Temperature  $\leq 0^\circ\text{C}$  and Thermistor Temperature  $\geq 45^\circ\text{C}$ .<sup>(2)</sup> In addition, when  $0^\circ\text{C} < \text{Thermistor Temperature} \leq 10^\circ\text{C}$ , the charge current remains at  $I_{CHG}$ .<sup>(1)</sup>

<sup>(1)</sup> During trickle charging, the charge current is limited to  $I_{CHG} \times 0.1$ .

<sup>(2)</sup> Even when charging is stopped, the  $t_{TRK}$  count and  $t_{CHG}$  count are continued and the charge status output pin maintains the ON state.

The thermistor temperature detection of this IC conforms to the characteristics of the NCP15XH103F03RC of Murata Manufacturing Co., Ltd.

## OPERATIONAL EXPLANATION (Continued)

Timing chart example

XC6803x4

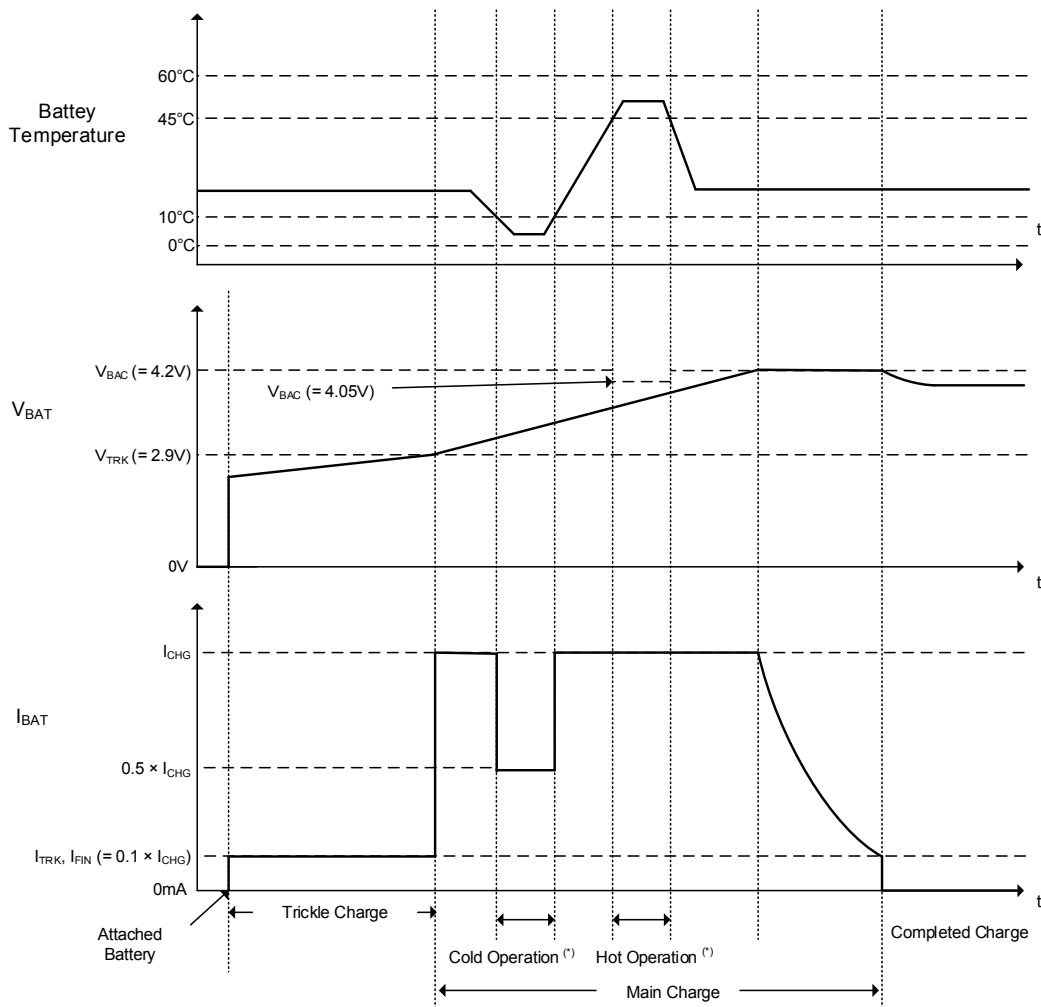

(\*) With regard to the detail of the Cold Operation and Hot Operation, please refer to “Li-ion battery temperature monitoring function” of the Operational Explanation.

## NOTES ON USE

1. For temporary, transitional voltage drop or voltage rising phenomenon, the IC is liable to malfunction should the ratings be exceeded.
2. Where wiring impedance is high, operations may become unstable. Please strengthen  $V_{IN}$  and  $V_{SS}$  wiring in particular.
3. Please wire the  $C_{IN}$  as close to the IC as possible.
4. Do not connect anything other than a resistance for setting the charge current to the  $I_{SET}$  pin.
5. Torex places an importance on improving our products and their reliability.  
We request that users incorporate fail-safe designs and post-aging protection treatment when using Torex products in their systems.
6. This IC uses an external thermistor to detect and control temperature with high accuracy.  
Please sufficiently test the position of the external thermistor to ensure that it enables accurate temperature detection.
7. Reversing the polarity of the battery may cause destruction and is extremely dangerous. Never reverse the polarity of the battery.
8. Short-circuiting to neighboring pins may cause malfunctioning and destruction. Exercise sufficient caution when mounting and using the IC.
9. If a large ripple voltage occurs at the  $V_{IN}$  pin, the IC may malfunction. Please test thoroughly.
10. Taking the temperature characteristics and the dispersion into consideration, please set the charge current not to exceed the range of 40mA to 280mA.
11. If the  $I_{SET}$  pin is shorted to the GND, there is a possibility that the IC is destroyed before the over-current monitor function is activated.
12. When  $V_{BAT}$  is 1V or less, the error range of the trickle charge current becomes big. When  $V_{IN} - V_{BAT}$  voltage is high in particular, please pay attention when using as there are possibilities that a large trickle current flows.

## TYPICAL PERFORMANCE CHARACTERISTICS

(1) CC Charge Current vs. External Resistor (Normal Operation)

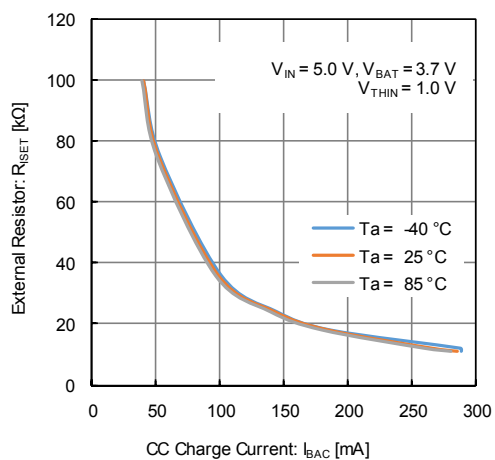

(2) CC Charge Current vs. Ambient Temperature (Normal Operation)

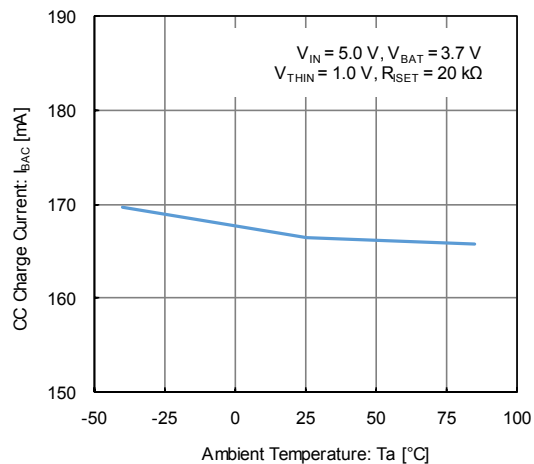

(3) CC Charge Current vs. Ambient Temperature (Cold Operation)

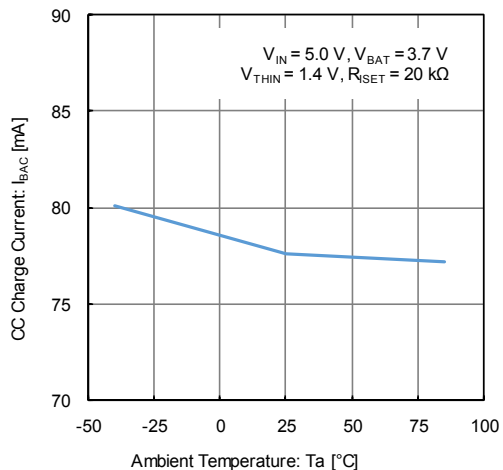

(4) Trickle Charge Current vs. Ambient Temperature

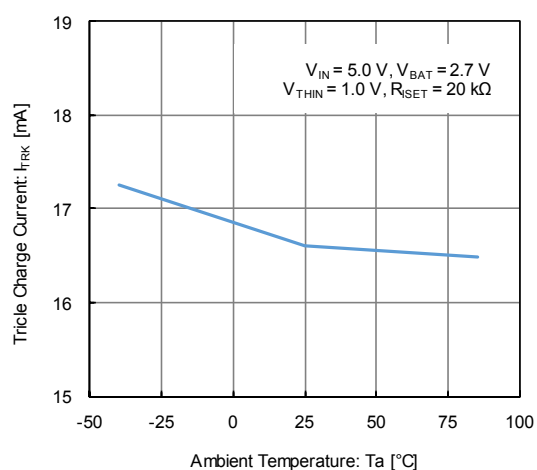

(5) Charge Completion Current vs. Ambient Temperature

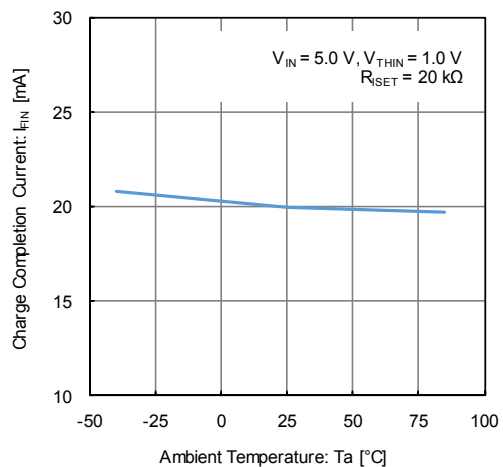

## TYPICAL PERFORMANCE CHARACTERISTICS (Continued)

(6) CV Charge Voltage vs. Charge Current (Normal Operation)

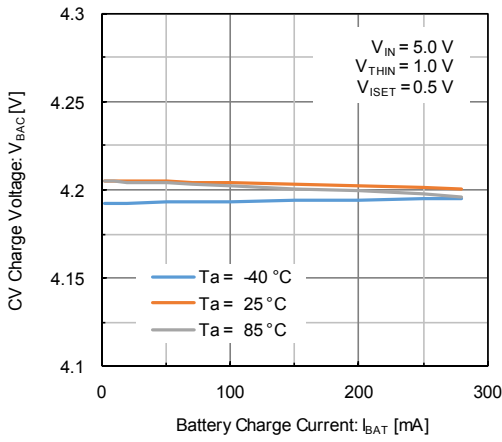

(7) CV Charge Voltage vs. Charge Current (Hot Operation)

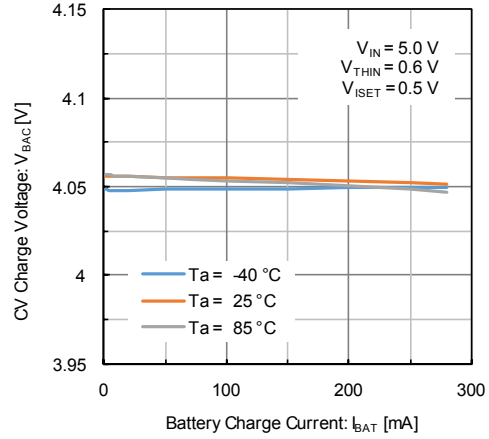

(8) Battery Charge Current vs. BAT Pin Voltage ( $R_{ISET} = 100$  k $\Omega$ , Normal Operation)

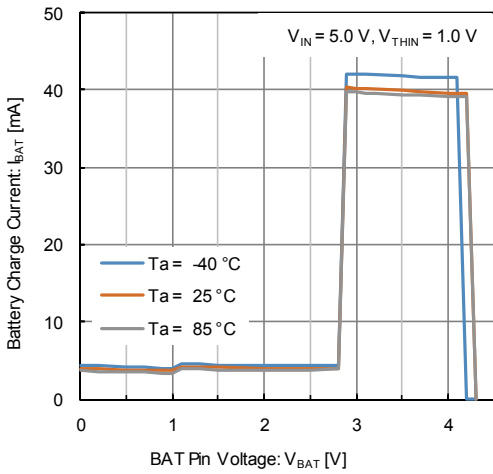

(9) Battery Charge Current vs. BAT Pin Voltage ( $R_{ISET} = 100$  k $\Omega$ , Cold Operation)

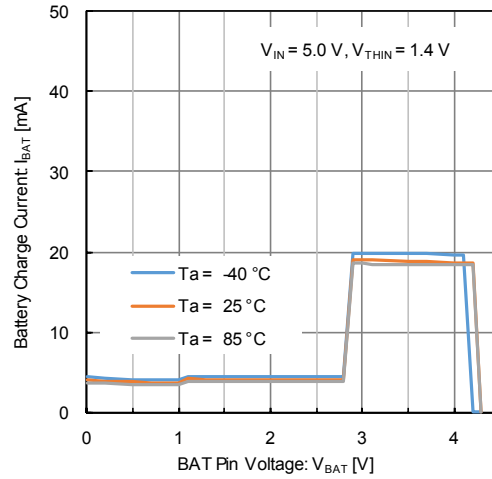

(10) Battery Charge Current vs. BAT Pin Voltage ( $R_{ISET} = 20$  k $\Omega$ , Normal Operation)

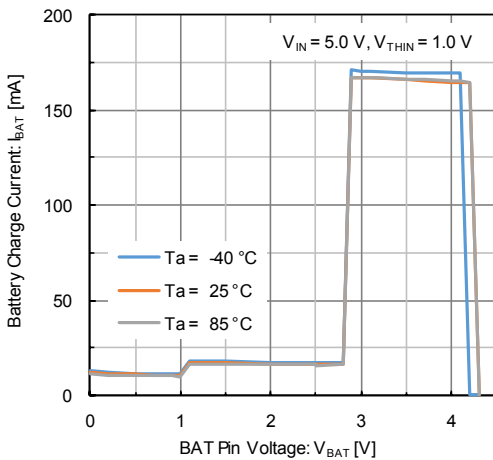

(11) Battery Charge Current vs. BAT Pin Voltage ( $R_{ISET} = 20$  k $\Omega$ , Cold Operation)

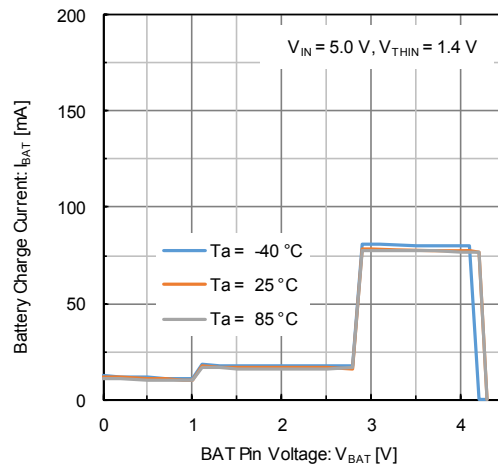

## TYPICAL PERFORMANCE CHARACTERISTICS (Continued)

(12) Battery Charge Current vs. BAT Pin Voltage  
( $R_{SET} = 11\text{ k}\Omega$ , Normal Operation)

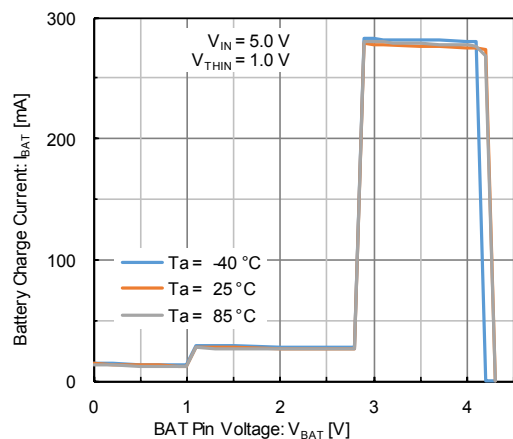

(13) Battery Charge Current vs. BAT Pin Voltage  
( $R_{SET} = 11\text{ k}\Omega$ , Cold Operation)

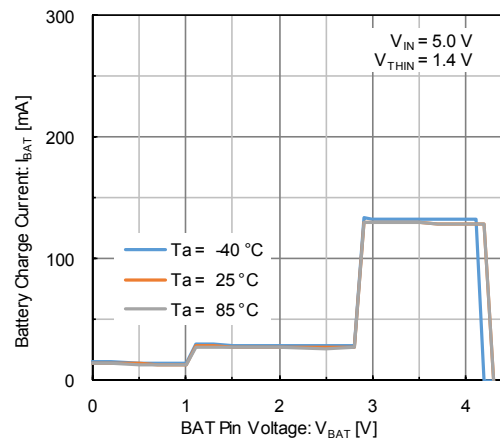

(14) Supply Current vs. Ambient Temperature

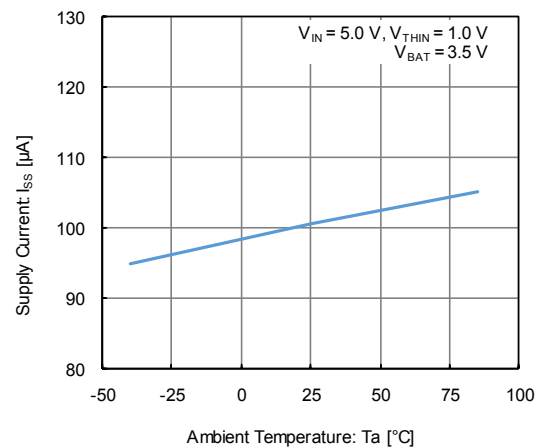

(15) Standby Current vs. Ambient Temperature

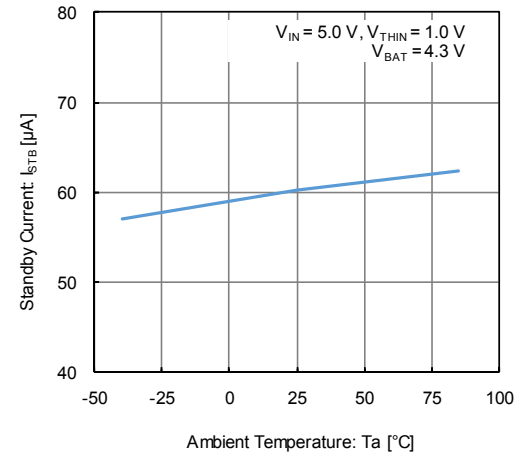

(16) VIN - VBAT Shut-down Voltage vs. Ambient Temperature

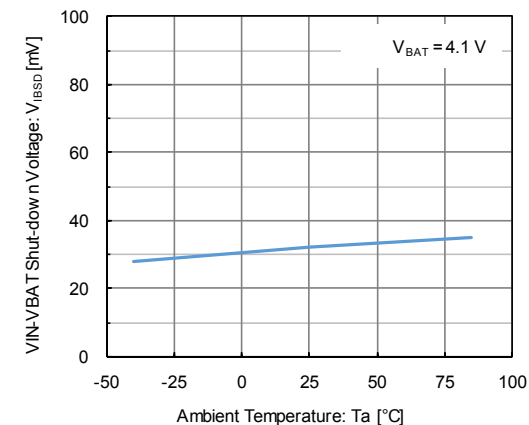

(17) Shut-down Hysteresis Voltage vs. Ambient Temperature

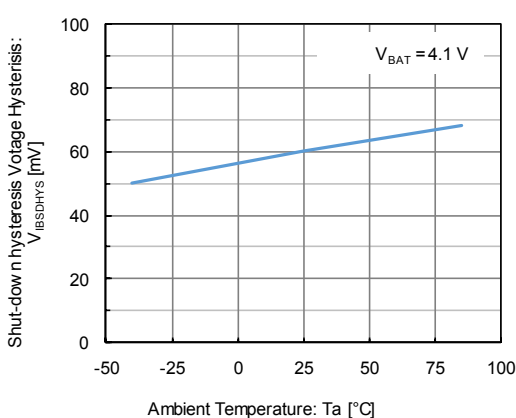

## TYPICAL PERFORMANCE CHARACTERISTICS (Continued)

(18) UVLO Voltage vs. Ambient Temperature

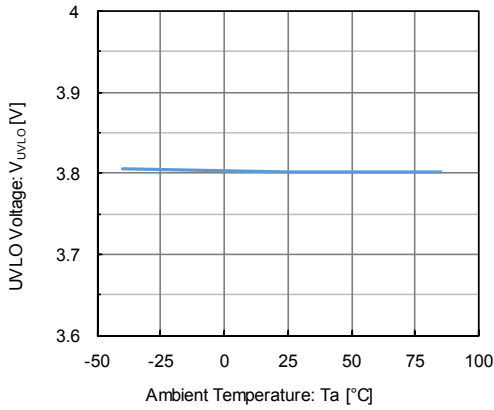

(19) UVLO Hysteresis Voltage vs. Ambient Temperature

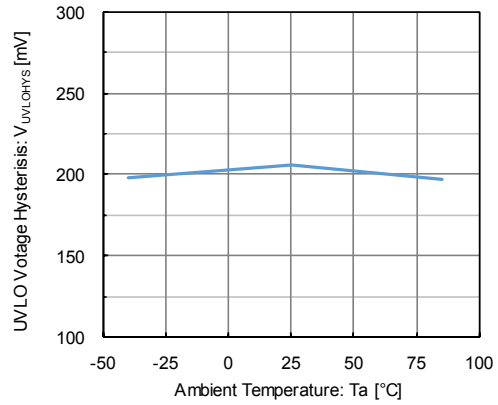

(20) Trickle Charge Voltage vs. Ambient Temperature

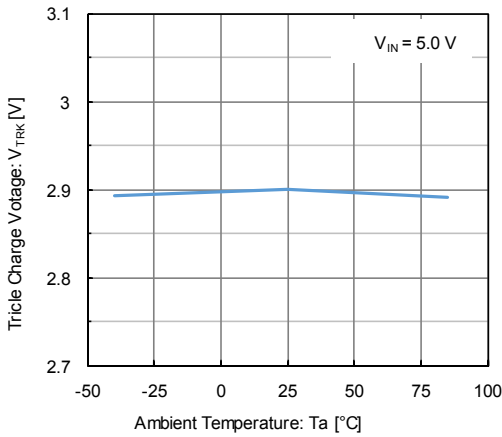

(21) Trickle Charge Hysteresis Voltage vs. Ambient Temperature

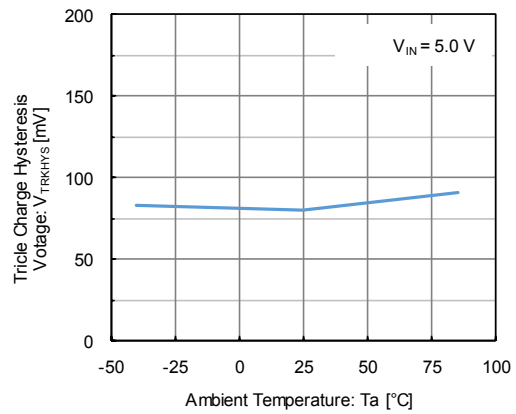

(22) Over Voltage Protection Threshold vs. Ambient Temperature

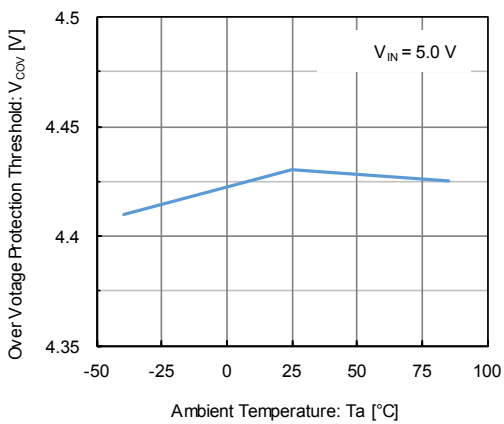

(23) Over Current Protection Threshold vs. Ambient Temperature

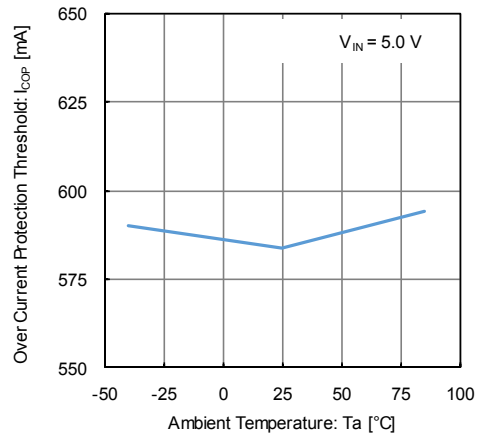



## TYPICAL PERFORMANCE CHARACTERISTICS (Continued)

(24) Driver ON Resistance vs. Ambient Temperature

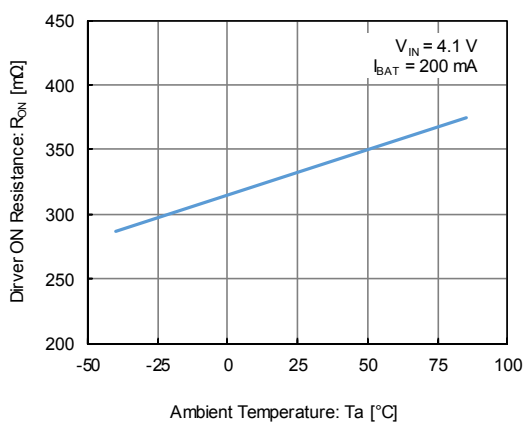

(25) Driver Leakage Current vs. Ambient Temperature

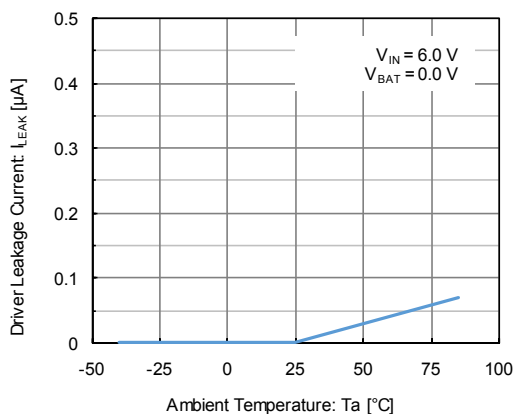

(26) BAT Pin Reverse Current vs. Ambient Temperature

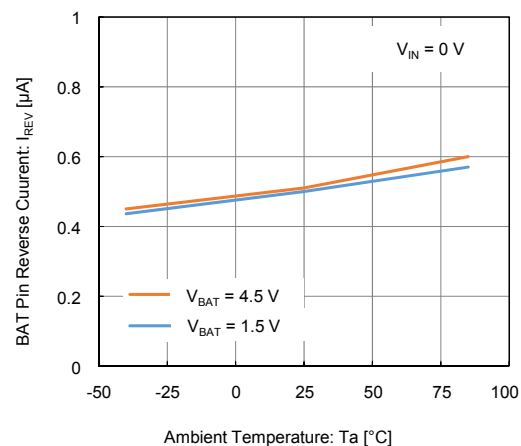

(27) BAT Pin Pull-down Current vs. Ambient Temperature

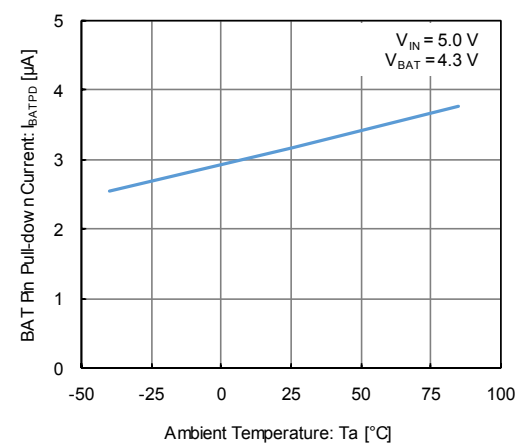

(28) Recharge Voltage vs. Ambient Temperature (Normal Operation)

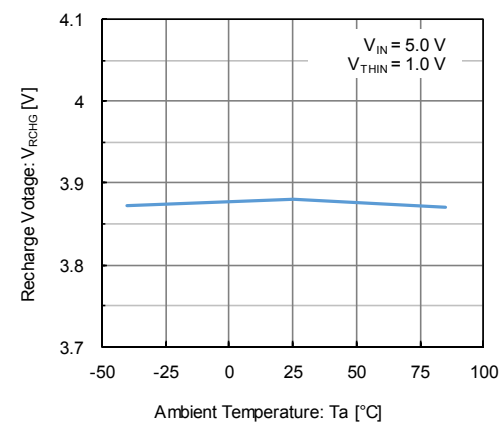

(29) Recharge Voltage vs. Ambient Temperature (Hot Operation)

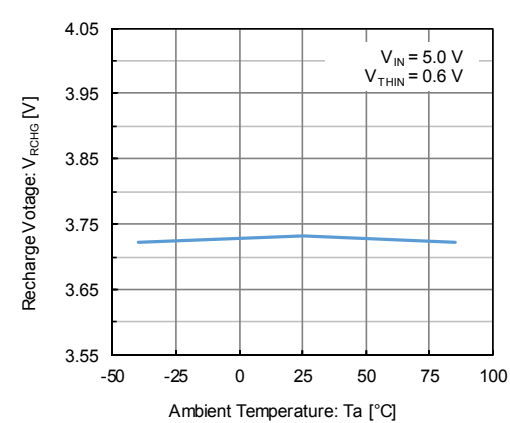

## TYPICAL PERFORMANCE CHARACTERISTICS (Continued)

(30) THIN Pin Open Voltage vs. Ambient Temperature

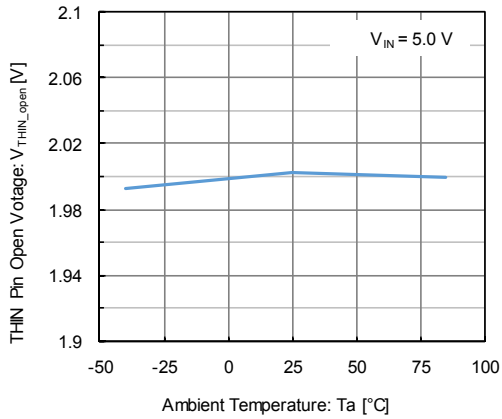

(31) THIN Pin Connected Resistance vs. Ambient Temperature

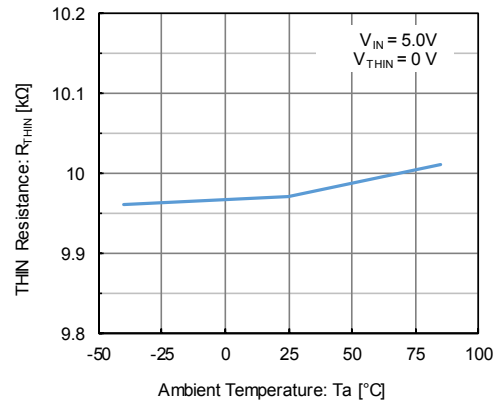

(32) Battery Connect Detection Voltage vs. Ambient Temperature

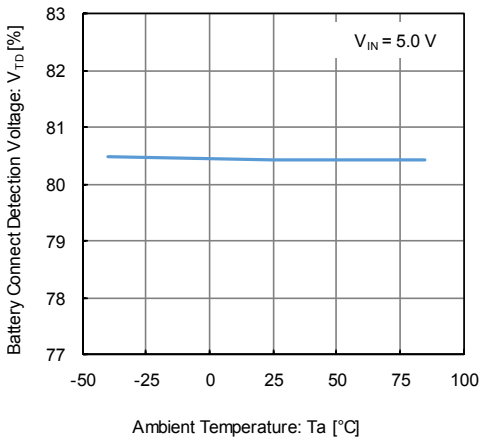

(33) Battery Connect Detection Hysteresis Voltage vs. Ambient Temperature

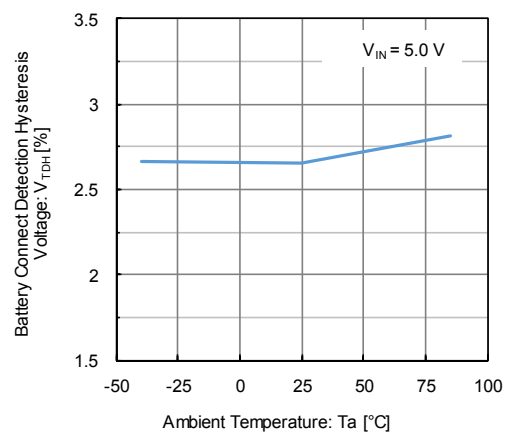

(34) Thermistor Detection at 0°C vs. Ambient Temperature

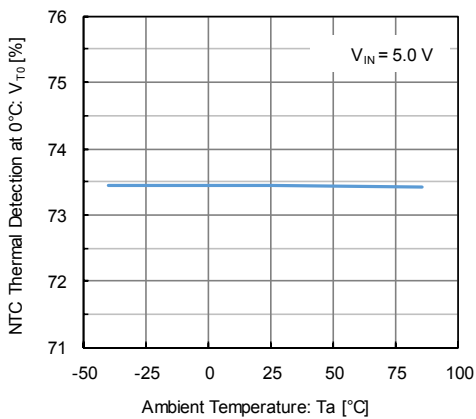

(35) Thermistor Detection Hysteresis at 0°C vs. Ambient Temperature

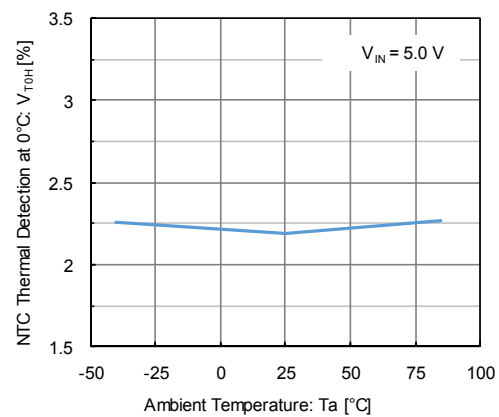

## ■ TYPICAL PERFORMANCE CHARACTERISTICS (Continued)

(36) Thermistor Detection at 10°C vs. Ambient Temperature

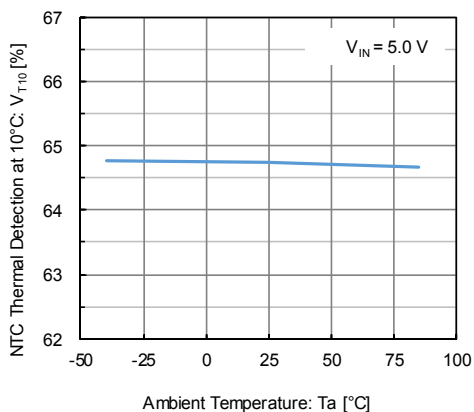

(37) Thermistor Detection Hysteresis at 10°C vs. Ambient Temperature

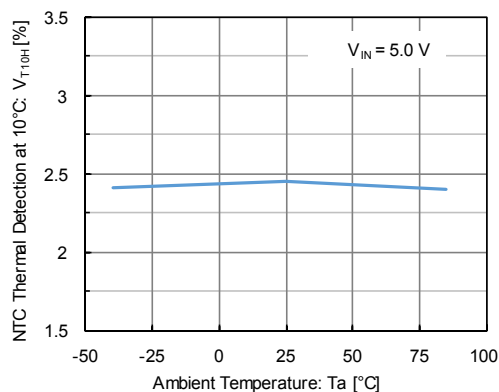

(38) Thermistor Detection at 45°C vs. Ambient Temperature

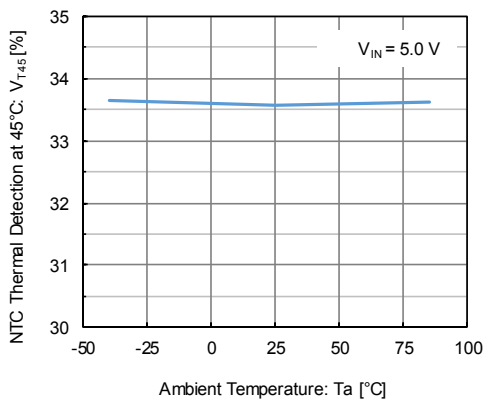

(39) Thermistor Detection Hysteresis at 45°C vs. Ambient Temperature

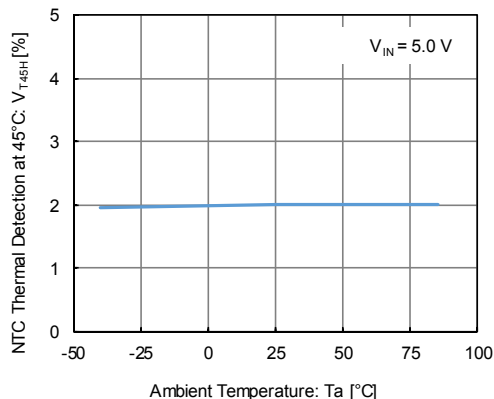

(40) Thermistor Detection at 60°C vs. Ambient Temperature

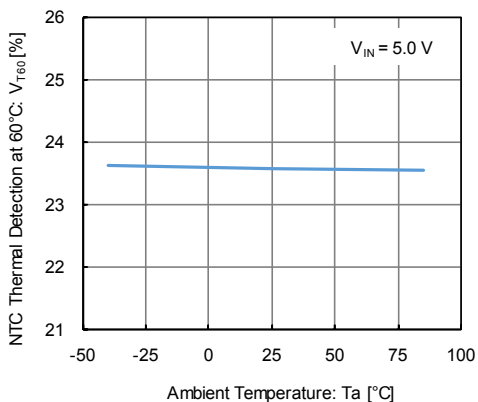

(41) Thermistor Detection Hysteresis at 60°C vs. Ambient Temperature

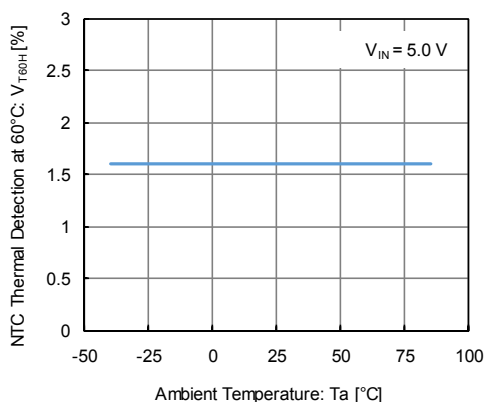

## TYPICAL PERFORMANCE CHARACTERISTICS (Continued)

(42) CSO Pin ON Voltage vs. Ambient Temperature

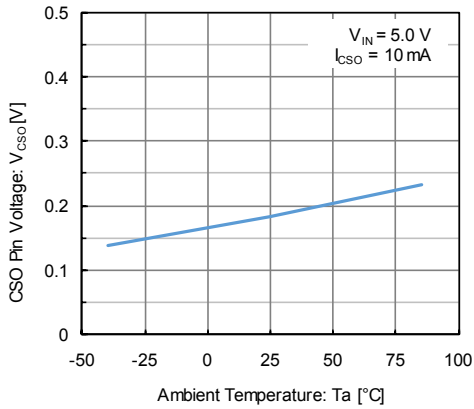

(43) CSO Pin OFF Current vs. Ambient Temperature

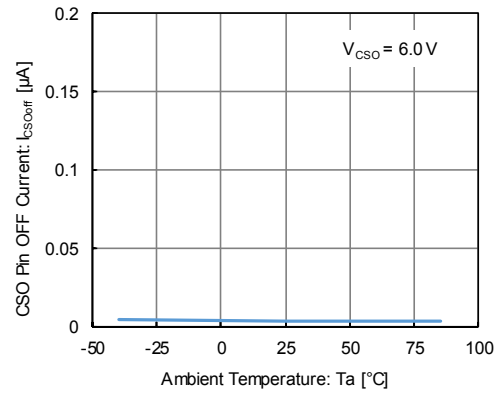

(44) CSO Frequency vs. Ambient Temperature

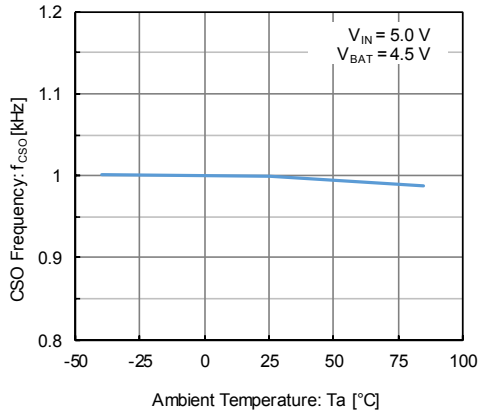

## PACKAGING INFORMATION

● USP-6EL(unit: mm)

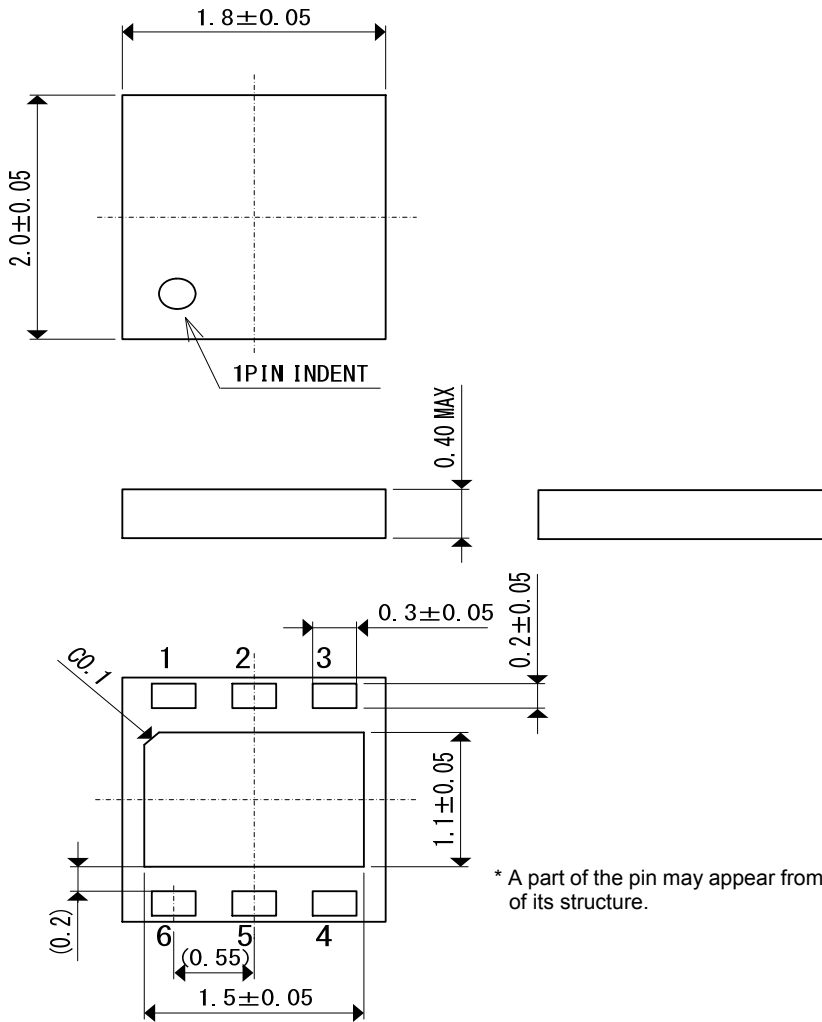

\* A part of the pin may appear from the side of the package because of its structure.

## PACKAGING INFORMATION (Continued)

- USP-6EL Reference Pattern Layout (unit: mm)

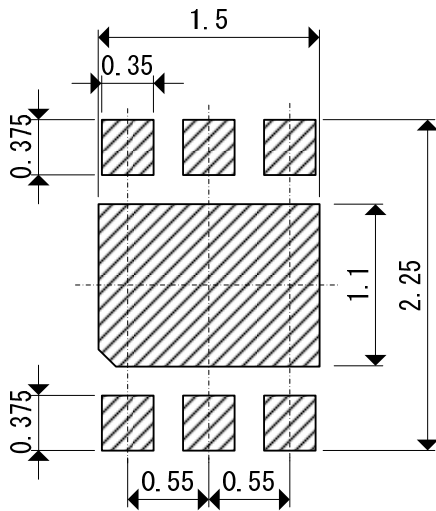

- USP-6EL Reference Metal Mask Design (unit: mm)

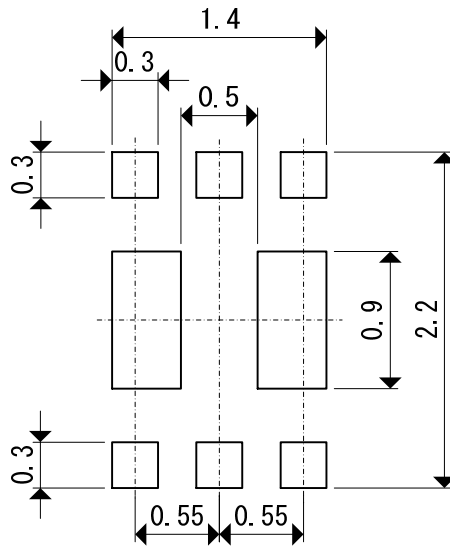

● USP-6EL (DAF) Power Dissipation

Power dissipation data for the USP-6EL is shown in this page.

The value of power dissipation varies with the mount board conditions.

Please use this data as one of reference data taken in the described condition.

1. Measurement Condition (Reference data)

- Condition: Mount on a board
- Ambient: Natural convection
- Soldering: Lead (Pb) free
- Board: Dimensions 40 x 40 mm (1600 mm<sup>2</sup> in one side)  
Copper (Cu) traces occupy 50% of the board area  
in top and back faces  
Package heat-sink is tied to the copper traces
- Material: Glass Epoxy (FR-4)
- Thickness: 1.6 mm
- Through-hole: 4 x 0.8 mm Diameter

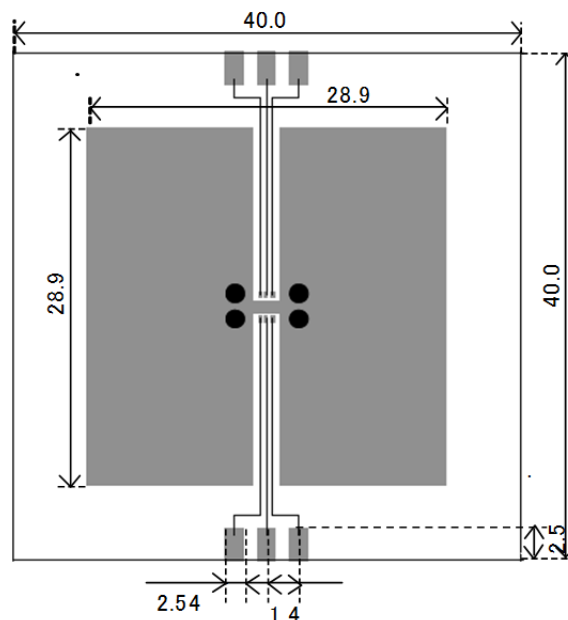

Evaluation board layout (Unit: mm)

2. Power Dissipation vs. Ambient Temperature

Board Mount ( $T_j$  max = 125°C)

Ambient Temperature (°C)	Power Dissipation Pd (mW)	Thermal Resistance (°C/W)
25	750	133.33
85	300	

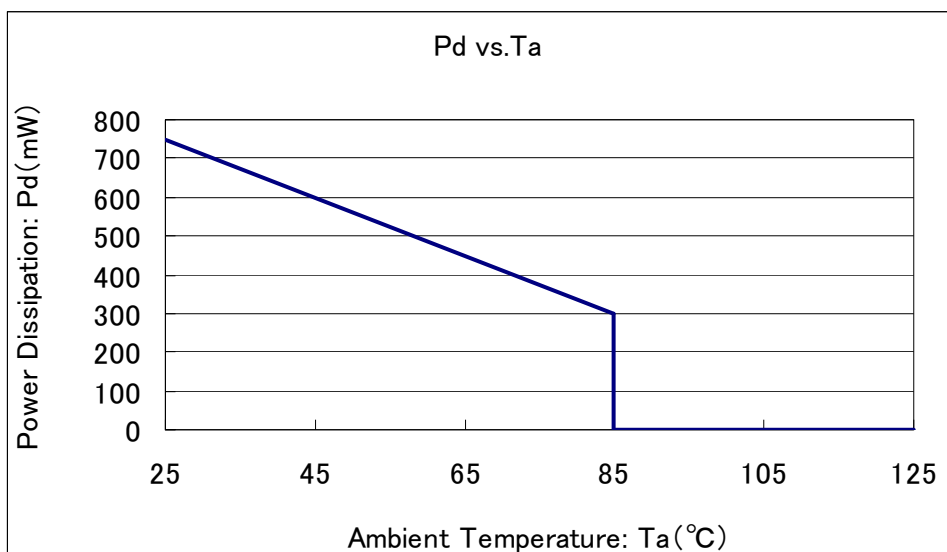

## MARKING RULE

### ● USP-6EL

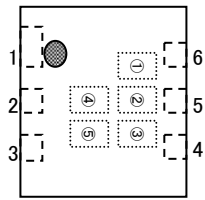

① represents product series

MARK	PRODUCT SERIES
3	XC6803*****-G

② represents charge status output on abnormal mode

MARK	PRODUCT SERIES
0	XC6803A*****-G
1	XC6803B*****-G

③ represents battery temperature monitor function and recharge function

MARK	Charge Status Output on Abnormal Mode	Battery Temperature Monitor Function	PRODUCT SERIES
H	2 Temperature Monitor	Enable	XC6803*2E**-G
F	2 Temperature Monitor	Disable	XC6803*2D**-G
E	3 Temperature Monitor	Enable	XC6803*3E**-G
D	3 Temperature Monitor	Disable	XC6803*3D**-G
C	4 Temperature Monitor	Enable	XC6803*4E**-G
B	4 Temperature Monitor	Disable	XC6803*4D**-G

④,⑤ represents production lot number

01 to 09, 0A to 0Z, 11 to 9Z, A1 to A9, AA to AZ, B1 to ZZ repeated  
(G, I, J, O, Q, W excluded)

\*No character inversion used.



1. The product and product specifications contained herein are subject to change without notice to improve performance characteristics. Consult us, or our representatives before use, to confirm that the information in this datasheet is up to date.
2. The information in this datasheet is intended to illustrate the operation and characteristics of our products. We neither make warranties or representations with respect to the accuracy or completeness of the information contained in this datasheet nor grant any license to any intellectual property rights of ours or any third party concerning with the information in this datasheet.
3. Applicable export control laws and regulations should be complied and the procedures required by such laws and regulations should also be followed, when the product or any information contained in this datasheet is exported.
4. The product is neither intended nor warranted for use in equipment of systems which require extremely high levels of quality and/or reliability and/or a malfunction or failure which may cause loss of human life, bodily injury, serious property damage including but not limited to devices or equipment used in 1) nuclear facilities, 2) aerospace industry, 3) medical facilities, 4) automobile industry and other transportation industry and 5) safety devices and safety equipment to control combustions and explosions. Do not use the product for the above use unless agreed by us in writing in advance.
5. Although we make continuous efforts to improve the quality and reliability of our products; nevertheless Semiconductors are likely to fail with a certain probability. So in order to prevent personal injury and/or property damage resulting from such failure, customers are required to incorporate adequate safety measures in their designs, such as system fail safes, redundancy and fire prevention features.
6. Our products are not designed to be Radiation-resistant.
7. Please use the product listed in this datasheet within the specified ranges.
8. We assume no responsibility for damage or loss due to abnormal use.
9. All rights reserved. No part of this datasheet may be copied or reproduced unless agreed by Torex Semiconductor Ltd in writing in advance.

TOREX SEMICONDUCTOR LTD.

Компания «Life Electronics» занимается поставками электронных компонентов импортного и отечественного производства от производителей и со складов крупных дистрибьюторов Европы, Америки и Азии.

С конца 2013 года компания активно расширяет линейку поставок компонентов по направлению коаксиальный кабель, кварцевые генераторы и конденсаторы (керамические, пленочные, электролитические), за счёт заключения дистрибьюторских договоров

Мы предлагаем:

- Конкурентоспособные цены и скидки постоянным клиентам.
- Специальные условия для постоянных клиентов.
- Подбор аналогов.
- Поставку компонентов в любых объемах, удовлетворяющих вашим потребностям.
- Приемлемые сроки поставки, возможна ускоренная поставка.
- Доставку товара в любую точку России и стран СНГ.
- Комплексную поставку.
- Работу по проектам и поставку образцов.
- Формирование склада под заказчика.
- Сертификаты соответствия на поставляемую продукцию (по желанию клиента).
- Тестирование поставляемой продукции.
- Поставку компонентов, требующих военную и космическую приемку.
- Входной контроль качества.
- Наличие сертификата ISO.

В составе нашей компании организован Конструкторский отдел, призванный помогать разработчикам, и инженерам.

Конструкторский отдел помогает осуществить:

- Регистрацию проекта у производителя компонентов.
- Техническую поддержку проекта.
- Защиту от снятия компонента с производства.
- Оценку стоимости проекта по компонентам.
- Изготовление тестовой платы монтаж и пусконаладочные работы.



Тел: +7 (812) 336 43 04 (многоканальный)

Email: [org@lifeelectronics.ru](mailto:org@lifeelectronics.ru)