

Optocoupler, Phototransistor Output

Features

- Extra low coupling capacity - typical 0.2 pF
- High Common Mode Rejection
- Four CTR groups available
- Lead-free component
- Component in accordance to RoHS 2002/95/EC and WEEE 2002/96/EC

Agency Approvals

- UL1577, File No. E76222 System Code A, Double Protection
- BSI IEC60950 IEC60065
- DIN EN 60747-5-2 (VDE0884)
DIN EN 60747-5-5 pending
- FIMKO

Applications

Switch-mode power supplies

Line receiver

Computer peripheral interface

Microprocessor system interface

Reinforced Isolation provides circuit protection against electrical shock (Safety Class II)

Circuits for safe protective separation against electrical shock according to safety class II (reinforced isolation):

- For appl. class I - IV at mains voltage ≤ 300 V
- For appl. class I - III at mains voltage ≤ 600 V according to DIN EN 60747-5-2(VDE0884)/ DIN EN 60747-5-5 pending, table 2.

Description

The TCDT1120(G) series consists of a phototransistor optically coupled to a gallium arsenide infrared-emitting diode in a 6-lead plastic dual inline package. The elements are mounted on one leadframe using a **coplanar technique**, providing a fixed distance between input and output for highest safety requirements.

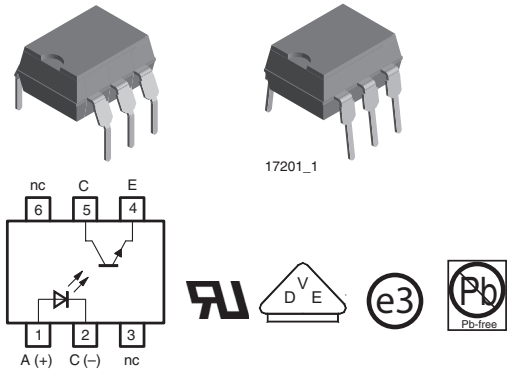

VDE Standards

These couplers perform safety functions according to the following equipment standards:

DIN EN 60747-5-2(VDE0884)/ DIN EN 60747-5-5 pending

Optocoupler for electrical safety requirements
IEC 60950/EN 60950

Office machines (applied for reinforced isolation for mains voltage ≤ 400 VRMS)

VDE 0804

Telecommunication apparatus and data processing
IEC 60065

Safety for mains-operated electronic and related household apparatus

Order Information

Part	Remarks
TCDT1120	CTR > 40 %, DIP-6
TCDT1122	CTR 63 - 125 %, DIP-6
TCDT1123	CTR 100 - 200 %, DIP-6
TCDT1124	CTR 160 - 320 %, DIP-6
TCDT1120G	CTR > 40 %, DIP-6
TCDT1122G	CTR 63 - 125 %, DIP-6
TCDT1123G	CTR 100 - 200 %, DIP-6
TCDT1124G	CTR 160 - 320 %, DIP-6

G = Leadform 10.16 mm; G is not marked on the body

Absolute Maximum Ratings

$T_{amb} = 25\text{ }^{\circ}\text{C}$, unless otherwise specified

Stresses in excess of the absolute Maximum Ratings can cause permanent damage to the device. Functional operation of the device is not implied at these or any other conditions in excess of those given in the operational sections of this document. Exposure to absolute Maximum Rating for extended periods of the time can adversely affect reliability.

Input

Parameter	Test condition	Symbol	Value	Unit
Reverse voltage		V_R	5	V
Forward current		I_F	60	mA
Forward surge current	$t_p \leq 10\text{ }\mu\text{s}$	I_{FSM}	3	A
Power dissipation		P_{diss}	100	mW
Junction temperature		T_j	125	$^{\circ}\text{C}$

Output

Parameter	Test condition	Symbol	Value	Unit
Collector base voltage		V_{CBO}	90	V
Collector emitter voltage		V_{CEO}	90	V
Emitter collector voltage		V_{ECO}	7	V
Collector current		I_C	50	mA
Collector peak current	$t_p/T = 0.5, t_p \leq 10\text{ ms}$	I_{CM}	100	mA
Power dissipation		P_{diss}	150	mW
Junction temperature		T_j	125	$^{\circ}\text{C}$

Coupler

Parameter	Test condition	Symbol	Value	Unit
Isolation test voltage (RMS)	$t = 1\text{ min}$	V_{ISO}	3750	V_{RMS}
Total power dissipation		P_{tot}	250	mW
Ambient temperature range		T_{amb}	- 55 to + 100	$^{\circ}\text{C}$
Storage temperature range		T_{stg}	- 55 to + 125	$^{\circ}\text{C}$
Soldering temperature	2 mm from case, $t \leq 10\text{ s}$	T_{sld}	260	$^{\circ}\text{C}$

Electrical Characteristics

$T_{amb} = 25\text{ }^{\circ}\text{C}$, unless otherwise specified

Minimum and maximum values are testing requirements. Typical values are characteristics of the device and are the result of engineering evaluation. Typical values are for information only and are not part of the testing requirements.

Input

Parameter	Test condition	Symbol	Min	Typ.	Max	Unit
Forward voltage	$I_F = 50\text{ mA}$	V_F		1.25	1.6	V
Junction capacitance	$V_R = 0, f = 1\text{ MHz}$	C_j		50		pF



Output

Parameter	Test condition	Symbol	Min	Typ.	Max	Unit
Collector base voltage	$I_C = 100 \mu A$	V_{CBO}	90			V
Collector emitter voltage	$I_C = 1 \text{ mA}$	V_{CEO}	90			V
Emitter collector voltage	$I_E = 100 \mu A$	V_{ECO}	7			V
Collector-emitter cut-off current	$V_{CE} = 20 \text{ V}, I_f = 0$	I_{CEO}			150	nA

Coupler

Parameter	Test condition	Symbol	Min	Typ.	Max	Unit
Collector emitter saturation voltage	$I_F = 10 \text{ mA}, I_C = 1 \text{ mA}$	V_{CEsat}			0.3	V
Cut-off frequency	$V_{CE} = 5 \text{ V}, I_F = 10 \text{ mA}, R_L = 100 \Omega$	f_c		110		kHz
Coupling capacitance	$f = 1 \text{ MHz}$	C_k		0.3		pF

Current Transfer Ratio

Parameter	Test condition	Part	Symbol	Min	Typ.	Max	Unit
I_C/I_F	$V_{CE} = 5 \text{ V}, I_F = 1 \text{ mA}$	TCDT1120 TCDT1120G	CTR	10			%
		TCDT1122 TCDT1122G	CTR	15			%
		TCDT1123 TCDT1123G	CTR	30			%
		TCDT1124 TCDT1124G	CTR	60			%
	$V_{CE} = 5 \text{ V}, I_F = 10 \text{ mA}$	TCDT1120 TCDT1120G	CTR	40			%
		TCDT1122 TCDT1122G	CTR	63		125	%
		TCDT1123 TCDT1123G	CTR	100		200	%
		TCDT1124 TCDT1124G	CTR	160		320	%

Maximum Safety Ratings

(according to DIN EN 60747-5-2(VDE0884)/ DIN EN 60747-5-5 pending) see figure 1

This optocoupler is suitable for safe electrical isolation only within the safety ratings.

Compliance with the safety ratings shall be ensured by means of suitable protective circuits.

Input

Parameter	Test condition	Symbol	Min	Typ.	Max	Unit
Forward current		I_F			130	mA

Output

Parameter	Test condition	Symbol	Min	Typ.	Max	Unit
Power dissipation		P_{diss}			265	mW

Coupler

Parameter	Test condition	Symbol	Min	Typ.	Max	Unit
Rated impulse voltage		V_{IOTM}			6	kV
Safety temperature		T_{si}			150	°C

Insulation Rated Parameters

Parameter	Test condition	Symbol	Min	Typ.	Max	Unit
Partial discharge test voltage - Routine test	100 %, $t_{test} = 1$ s	V_{pd}	1.6			kV
Partial discharge test voltage - Lot test (sample test)	$t_{Tr} = 60$ s, $t_{test} = 10$ s, (see figure 2)	V_{IOTM}	6			kV
		V_{pd}	1.3			kV
Insulation resistance	$V_{IO} = 500$ V	R_{IO}	10^{12}			Ω
	$V_{IO} = 500$ V, $T_{amb} \leq 100$ °C	R_{IO}	10^{11}			Ω
	$V_{IO} = 500$ V, $T_{amb} \leq 150$ °C (construction test only)	R_{IO}	10^9			Ω

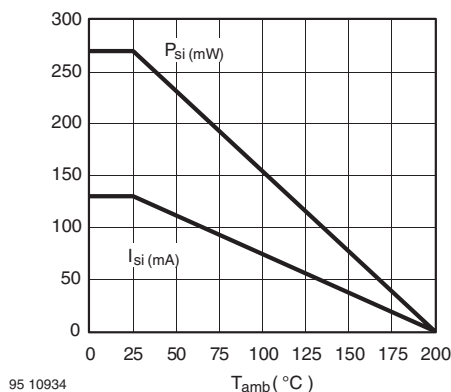

Figure 1. Derating diagram

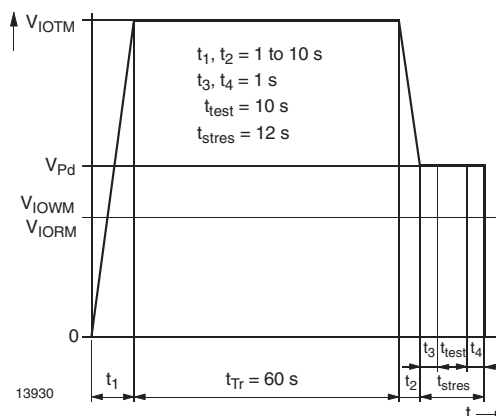

Figure 2. Test pulse diagram for sample test according to DIN EN 60747-5-2(VDE0884)/ DIN EN 60747-; IEC60747

Switching Characteristics

Parameter	Current	Delay	Rise time	Storage	Fall time	Turn-on time	Turn-off time	Turn-on time	Turn-off time	
Test condition	$V_S = 5$ V, $R_L = 100$ Ω (see figure 3)						$V_S = 5$ V, $R_L = 1$ k Ω (see figure 4)			
Symbol	I_F	t_D	t_r	t_S	t_f	t_{on}	t_{off}	t_{on}	t_{off}	
Unit	mA	μ s	μ s	μ s	μ s	μ s	μ s	μ s	μ s	
TCDT1120 TCDT1120G	10	2.5	3.0	0.3	3.7	5.5	4.0	16.5	22.5	
	10	2.5	3.0	0.3	3.7	5.5	4.0	16.5	22.5	
TCDT1123 TCDT1123G	10	2.8	4.2	0.3	4.7	7.0	5.0	21.5	37.5	
TCDT1124 TCDT1124G	10	2.0	4.0	0.3	4.7	6.0	5.0	20.0	50.0	

Typical Characteristics ($T_{amb} = 25\text{ }^{\circ}\text{C}$ unless otherwise specified)

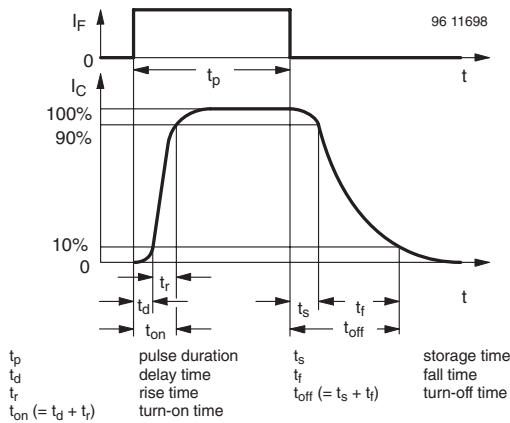

Figure 3. Switching Times

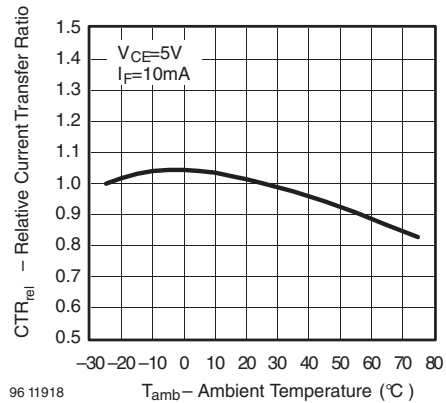

Figure 6. Relative Current Transfer Ratio vs. Ambient Temperature

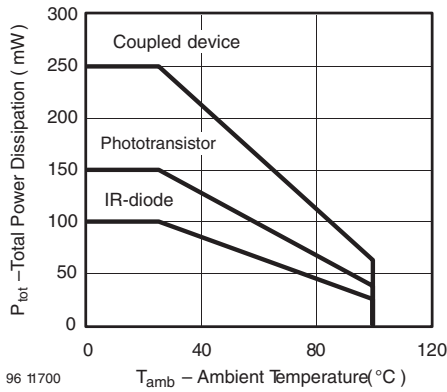

Figure 4. Total Power Dissipation vs. Ambient Temperature

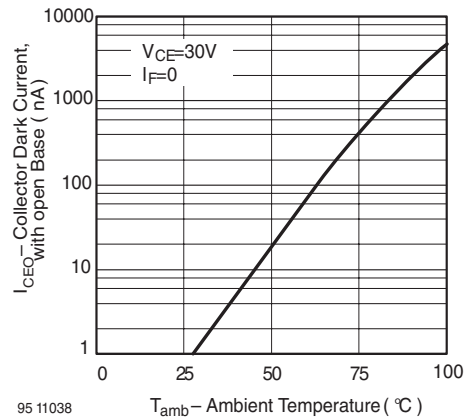

Figure 7. Collector Dark Current vs. Ambient Temperature

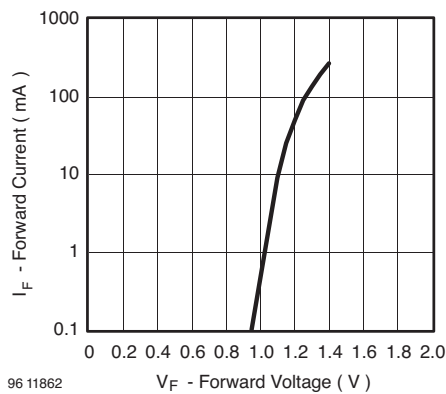

Figure 5. Forward Current vs. Forward Voltage

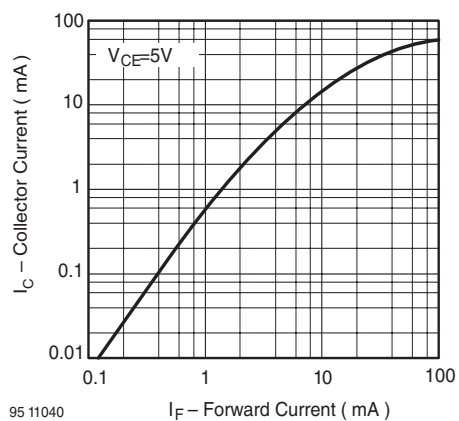
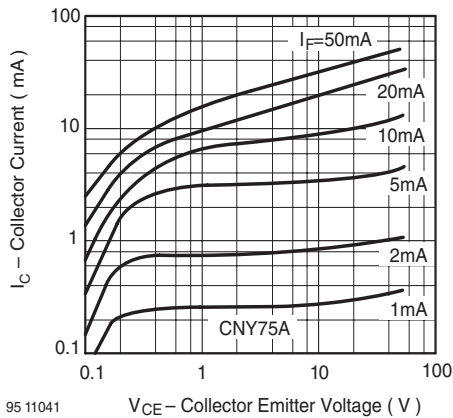
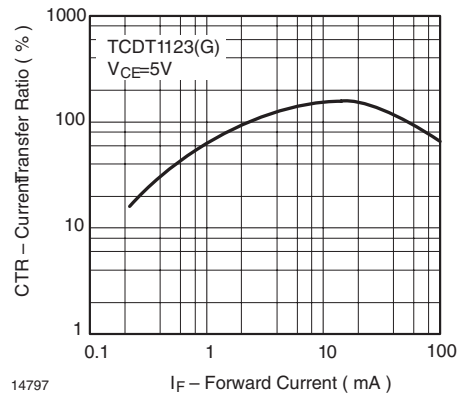

Figure 8. Collector Current vs. Forward Current



95 11041
 Figure 9. Collector Current vs. Collector Emitter Voltage



14797
 Figure 12. Current Transfer Ratio vs. Forward Current

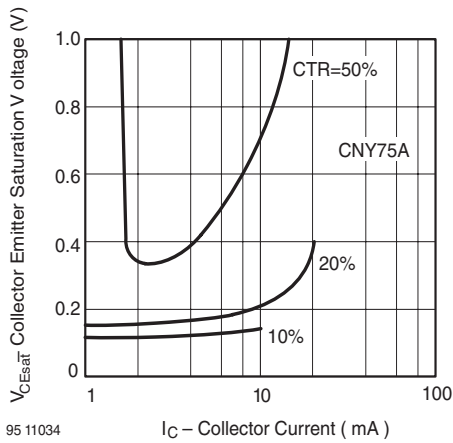

95 11034
 Figure 10. Collector Emitter Saturation Voltage vs. Collector Current

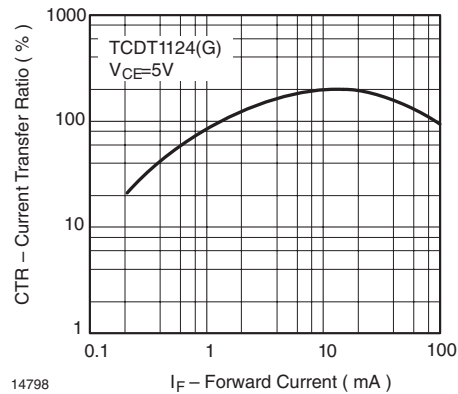

14798
 Figure 13. Current Transfer Ratio vs. Forward Current

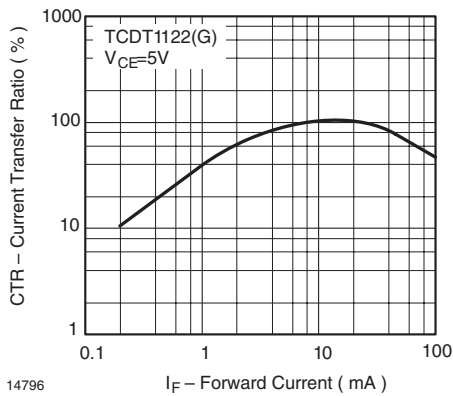

14796
 Figure 11. Current Transfer Ratio vs. Forward Current

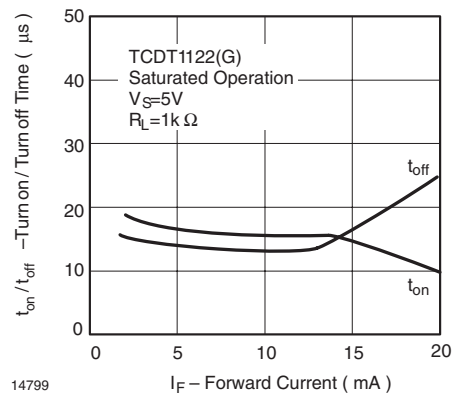

14799
 Figure 14. Turn on / off Time vs. Forward Current

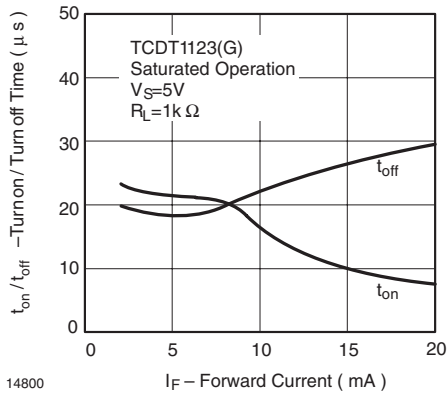

Figure 15. Turn on / off Time vs. Forward Current

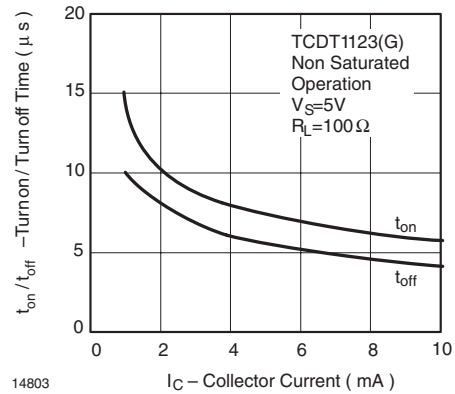

Figure 18. Turn on / off Time vs. Collector Current

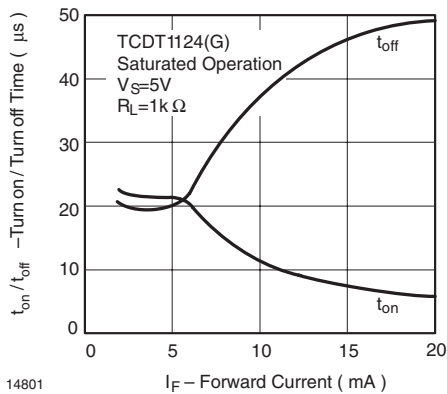

Figure 16. Turn on / off Time vs. Forward Current

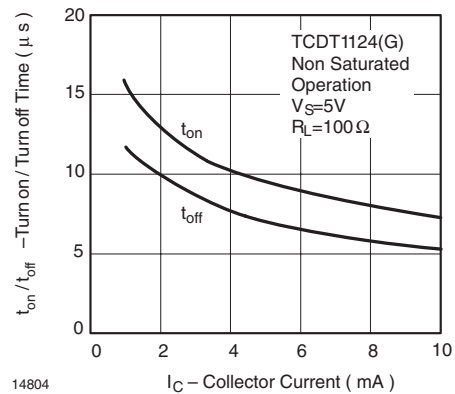

Figure 19. Turn on / off Time vs. Collector Current

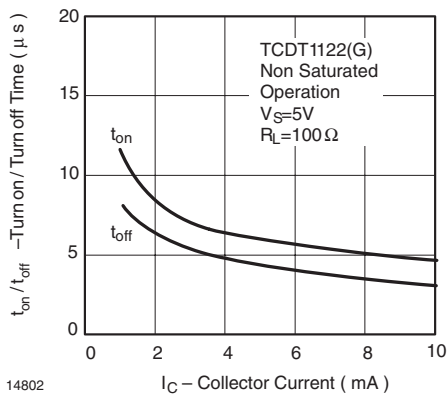

Figure 17. Turn on / off Time vs. Collector Current

TCDT1120/ TCDT1120G



Vishay Semiconductors

Package Dimensions in mm

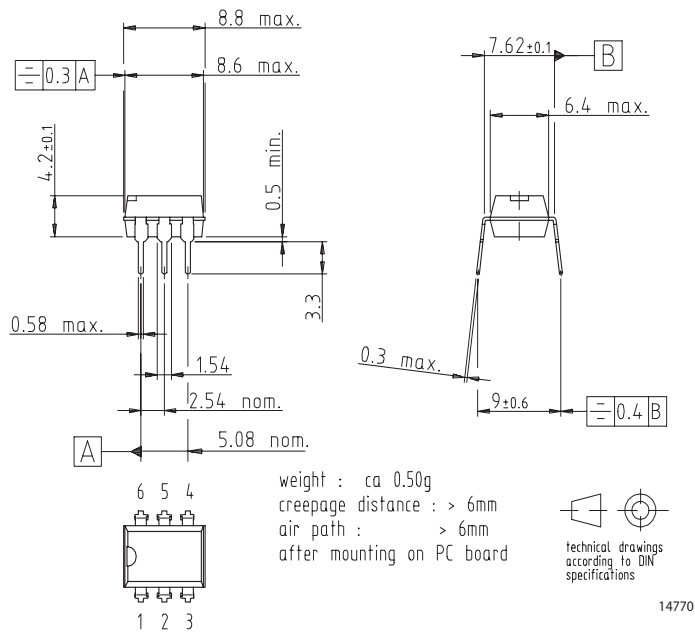

Package Dimensions in mm

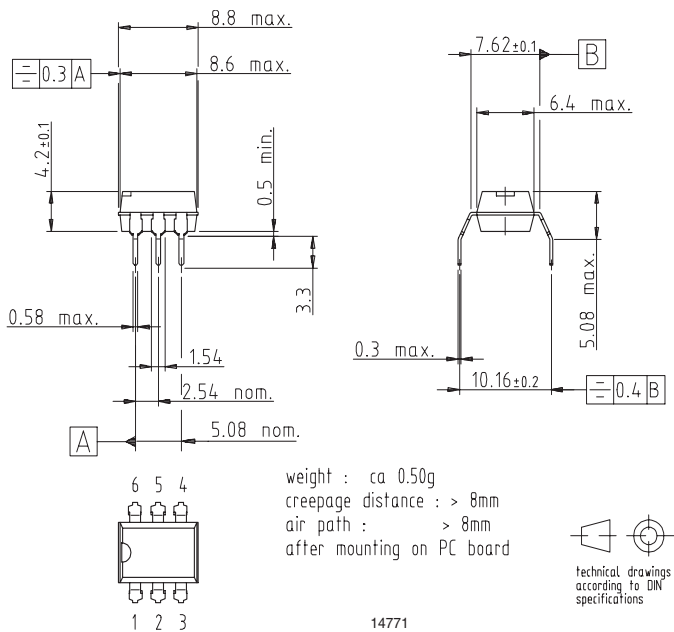



Ozone Depleting Substances Policy Statement

It is the policy of Vishay Semiconductor GmbH to

1. Meet all present and future national and international statutory requirements.
2. Regularly and continuously improve the performance of our products, processes, distribution and operating systems with respect to their impact on the health and safety of our employees and the public, as well as their impact on the environment.

It is particular concern to control or eliminate releases of those substances into the atmosphere which are known as ozone depleting substances (ODSs).

The Montreal Protocol (1987) and its London Amendments (1990) intend to severely restrict the use of ODSs and forbid their use within the next ten years. Various national and international initiatives are pressing for an earlier ban on these substances.

Vishay Semiconductor GmbH has been able to use its policy of continuous improvements to eliminate the use of ODSs listed in the following documents.

1. Annex A, B and list of transitional substances of the Montreal Protocol and the London Amendments respectively
2. Class I and II ozone depleting substances in the Clean Air Act Amendments of 1990 by the Environmental Protection Agency (EPA) in the USA
3. Council Decision 88/540/EEC and 91/690/EEC Annex A, B and C (transitional substances) respectively.

Vishay Semiconductor GmbH can certify that our semiconductors are not manufactured with ozone depleting substances and do not contain such substances.

We reserve the right to make changes to improve technical design and may do so without further notice.

Parameters can vary in different applications. All operating parameters must be validated for each customer application by the customer. Should the buyer use Vishay Semiconductors products for any unintended or unauthorized application, the buyer shall indemnify Vishay Semiconductors against all claims, costs, damages, and expenses, arising out of, directly or indirectly, any claim of personal damage, injury or death associated with such unintended or unauthorized use.

Vishay Semiconductor GmbH, P.O.B. 3535, D-74025 Heilbronn, Germany
Telephone: 49 (0)7131 67 2831, Fax number: 49 (0)7131 67 2423



Notice

Specifications of the products displayed herein are subject to change without notice. Vishay Intertechnology, Inc., or anyone on its behalf, assumes no responsibility or liability for any errors or inaccuracies.

Information contained herein is intended to provide a product description only. No license, express or implied, by estoppel or otherwise, to any intellectual property rights is granted by this document. Except as provided in Vishay's terms and conditions of sale for such products, Vishay assumes no liability whatsoever, and disclaims any express or implied warranty, relating to sale and/or use of Vishay products including liability or warranties relating to fitness for a particular purpose, merchantability, or infringement of any patent, copyright, or other intellectual property right.

The products shown herein are not designed for use in medical, life-saving, or life-sustaining applications. Customers using or selling these products for use in such applications do so at their own risk and agree to fully indemnify Vishay for any damages resulting from such improper use or sale.

Компания «Life Electronics» занимается поставками электронных компонентов импортного и отечественного производства от производителей и со складов крупных дистрибьюторов Европы, Америки и Азии.

С конца 2013 года компания активно расширяет линейку поставок компонентов по направлению коаксиальный кабель, кварцевые генераторы и конденсаторы (керамические, пленочные, электролитические), за счёт заключения дистрибьюторских договоров

Мы предлагаем:

- Конкурентоспособные цены и скидки постоянным клиентам.
- Специальные условия для постоянных клиентов.
- Подбор аналогов.
- Поставку компонентов в любых объемах, удовлетворяющих вашим потребностям.
- Приемлемые сроки поставки, возможна ускоренная поставка.
- Доставку товара в любую точку России и стран СНГ.
- Комплексную поставку.
- Работу по проектам и поставку образцов.
- Формирование склада под заказчика.
- Сертификаты соответствия на поставляемую продукцию (по желанию клиента).
- Тестирование поставляемой продукции.
- Поставку компонентов, требующих военную и космическую приемку.
- Входной контроль качества.
- Наличие сертификата ISO.

В составе нашей компании организован Конструкторский отдел, призванный помогать разработчикам, и инженерам.

Конструкторский отдел помогает осуществить:

- Регистрацию проекта у производителя компонентов.
- Техническую поддержку проекта.
- Защиту от снятия компонента с производства.
- Оценку стоимости проекта по компонентам.
- Изготовление тестовой платы монтаж и пусконаладочные работы.



Тел: +7 (812) 336 43 04 (многоканальный)

Email: org@lifeelectronics.ru