



Is Now Part of



**ON Semiconductor®**

To learn more about ON Semiconductor, please visit our website at  
[www.onsemi.com](http://www.onsemi.com)

Please note: As part of the Fairchild Semiconductor integration, some of the Fairchild orderable part numbers will need to change in order to meet ON Semiconductor's system requirements. Since the ON Semiconductor product management systems do not have the ability to manage part nomenclature that utilizes an underscore (\_), the underscore (\_) in the Fairchild part numbers will be changed to a dash (-). This document may contain device numbers with an underscore (\_). Please check the ON Semiconductor website to verify the updated device numbers. The most current and up-to-date ordering information can be found at [www.onsemi.com](http://www.onsemi.com). Please email any questions regarding the system integration to [Fairchild\\_questions@onsemi.com](mailto:Fairchild_questions@onsemi.com).

ON Semiconductor and the ON Semiconductor logo are trademarks of Semiconductor Components Industries, LLC dba ON Semiconductor or its subsidiaries in the United States and/or other countries. ON Semiconductor owns the rights to a number of patents, trademarks, copyrights, trade secrets, and other intellectual property. A listing of ON Semiconductor's product/patent coverage may be accessed at [www.onsemi.com/site/pdf/Patent-Marking.pdf](http://www.onsemi.com/site/pdf/Patent-Marking.pdf). ON Semiconductor reserves the right to make changes without further notice to any products herein. ON Semiconductor makes no warranty, representation or guarantee regarding the suitability of its products for any particular purpose, nor does ON Semiconductor assume any liability arising out of the application or use of any product or circuit, and specifically disclaims any and all liability, including without limitation special, consequential or incidental damages. Buyer is responsible for its products and applications using ON Semiconductor products, including compliance with all laws, regulations and safety requirements or standards, regardless of any support or applications information provided by ON Semiconductor. "Typical" parameters which may be provided in ON Semiconductor data sheets and/or specifications can and do vary in different applications and actual performance may vary over time. All operating parameters, including "Typicals" must be validated for each customer application by customer's technical experts. ON Semiconductor does not convey any license under its patent rights nor the rights of others. ON Semiconductor products are not designed, intended, or authorized for use as a critical component in life support systems or any FDA Class 3 medical devices or medical devices with a same or similar classification in a foreign jurisdiction or any devices intended for implantation in the human body. Should Buyer purchase or use ON Semiconductor products for any such unintended or unauthorized application, Buyer shall indemnify and hold ON Semiconductor and its officers, employees, subsidiaries, affiliates, and distributors harmless against all claims, costs, damages, and expenses, and reasonable attorney fees arising out of, directly or indirectly, any claim of personal injury or death associated with such unintended or unauthorized use, even if such claim alleges that ON Semiconductor was negligent regarding the design or manufacture of the part. ON Semiconductor is an Equal Opportunity/Affirmative Action Employer. This literature is subject to all applicable copyright laws and is not for resale in any manner.

# 74AC14, 74ACT14

## Hex Inverter with Schmitt Trigger Input

### Features

- $I_{CC}$  reduced by 50%
- Outputs source/sink 24mA
- 74ACT14 has TTL-compatible inputs

### General Description

The 74AC14 and 74ACT14 contain six inverter gates each with a Schmitt trigger input. They are capable of transforming slowly changing input signals into sharply defined, jitter-free output signals. In addition, they have a greater noise margin than conventional inverters.

The 74AC14 and 74ACT14 have hysteresis between the positive-going and negative-going input thresholds (typically 1.0V) which is determined internally by transistor ratios and is essentially insensitive to temperature and supply voltage variations.

### Ordering Information

Order Number	Package Number	Package Description
74AC14SC	M14A	14-Lead Small Outline Integrated Circuit (SOIC), JEDEC MS-012, 0.150" Narrow
74AC14SJ	M14D	14-Lead Small Outline Package (SOP), EIAJ TYPE II, 5.3mm Wide
74AC14MTC	MTC14	14-Lead Thin Shrink Small Outline Package (TSSOP), JEDEC MO-153, 4.4mm Wide
74ACT14SC	M14A	14-Lead Small Outline Integrated Circuit (SOIC), JEDEC MS-012, 0.150" Narrow
74ACT14MTC	MTC14	14-Lead Thin Shrink Small Outline Package (TSSOP), JEDEC MO-153, 4.4mm Wide

Device also available in Tape and Reel. Specify by appending suffix letter "X" to the ordering number.

### Connection Diagram



### Logic Symbol



### Pin Description

Pin Names	Description
$I_n$	Inputs
$\bar{O}_n$	Outputs

### Function Table

Input	Output
<b>A</b>	<b>O</b>
L	H
H	L

## Absolute Maximum Ratings

Stresses exceeding the absolute maximum ratings may damage the device. The device may not function or be operable above the recommended operating conditions and stressing the parts to these levels is not recommended. In addition, extended exposure to stresses above the recommended operating conditions may affect device reliability. The absolute maximum ratings are stress ratings only.

Symbol	Parameter	Rating
$V_{CC}$	Supply Voltage	-0.5V to +7.0V
$I_{IK}$	DC Input Diode Current $V_I = -0.5V$	-20mA
	$V_I = V_{CC} + 1.5$	+20mA
$V_I$	DC Input Voltage	-0.5V to $V_{CC} + 1.5V$
$I_{OK}$	DC Output Diode Current $V_O = -0.5V$	-20mA
	$V_O = V_{CC} + 0.5V$	+20mA
$V_O$	DC Output Voltage	-0.5V to $V_{CC} + 0.5V$
$I_O$	DC Output Source or Sink Current	$\pm 50mA$
$I_{CC}$ or $I_{GND}$	DC $V_{CC}$ or Ground Current per Output Pin	$\pm 50mA$
$T_{STG}$	Storage Temperature	-65°C to +150°C
$T_J$	Junction Temperature	140°C

## Recommended Operating Conditions

The Recommended Operating Conditions table defines the conditions for actual device operation. Recommended operating conditions are specified to ensure optimal performance to the datasheet specifications. Fairchild does not recommend exceeding them or designing to absolute maximum ratings.

Symbol	Parameter	Rating
$V_{CC}$	Supply Voltage AC	2.0V to 6.0V
	ACT	4.5V to 5.5V
$V_I$	Input Voltage	0V to $V_{CC}$
$V_O$	Output Voltage	0V to $V_{CC}$
$T_A$	Operating Temperature	-40°C to +85°C

## DC Electrical Characteristics for AC

Symbol	Parameter	V <sub>CC</sub> (V)	Conditions	T <sub>A</sub> = +25°C		T <sub>A</sub> = -40°C to +85°C	Units	
				Typ	Guaranteed Limits			
V <sub>OH</sub>	Minimum HIGH Level Output Voltage	3.0	I <sub>OUT</sub> = -50μA	2.99	2.9	2.9	V	
		4.5		4.49	4.4	4.4		
		5.5		5.49	5.4	5.4		
		3.0	I <sub>OH</sub> = 12mA		2.56	2.46		
		4.5		I <sub>OH</sub> = 24mA		3.86		3.76
		5.5		I <sub>OH</sub> = 24mA <sup>(1)</sup>		4.86		4.76
V <sub>OL</sub>	Maximum LOW Level Output Voltage	3.0	I <sub>OUT</sub> = 50μA	0.002	0.1	0.1	V	
		4.5		0.001	0.1	0.1		
		5.5		0.001	0.1	0.1		
		3.0	I <sub>OL</sub> = 12mA		0.36	0.44		
		4.5		I <sub>OL</sub> = 24mA		0.36		0.44
		5.5		I <sub>OL</sub> = 24mA <sup>(1)</sup>		0.36		0.44
I <sub>IN</sub> <sup>(3)</sup>	Maximum Input Leakage Current	5.5	V <sub>I</sub> = V <sub>CC</sub> , GND		±0.1	±1.0	μA	
V <sub>t+</sub>	Maximum Positive Threshold	3.0	T <sub>A</sub> = Worst Case		2.2	2.2	V	
		4.5			3.2	3.2		
		5.5			3.9	3.9		
V <sub>t-</sub>	Minimum Negative Threshold	3.0	T <sub>A</sub> = Worst Case		0.5	0.5	V	
		4.5			0.9	0.9		
		5.5			1.1	1.1		
V <sub>H(MAX)</sub>	Maximum Hysteresis	3.0	T <sub>A</sub> = Worst Case		1.2	1.2	V	
		4.5			1.4	1.4		
		5.5			1.6	1.6		
V <sub>H(MIN)</sub>	Minimum Hysteresis	3.0	T <sub>A</sub> = Worst Case		0.3	0.3	V	
		4.5			0.4	0.4		
		5.5			0.5	0.5		
I <sub>OLD</sub>	Minimum Dynamic	5.5	V <sub>OLD</sub> = 1.65V Max.			75	mA	
I <sub>OHD</sub>	Output Current <sup>(2)</sup>	5.5	V <sub>OHD</sub> = 3.85V Min.			-75	mA	
I <sub>CC</sub> <sup>(3)</sup>	Maximum Quiescent Supply Current	5.5	V <sub>IN</sub> = V <sub>CC</sub> or GND		2.0	20.0	μA	

## Notes:

1. All outputs loaded; thresholds on input associated with output under test.
2. Maximum test duration 2.0ms, one output loaded at a time.
3. I<sub>IN</sub> and I<sub>CC</sub> @ 3.0V are guaranteed to be less than or equal to the respective limit @ 5.5V V<sub>CC</sub>.

## DC Electrical Characteristics for ACT

Symbol	Parameter	V <sub>CC</sub> (V)	Conditions	T <sub>A</sub> = +25°C		T <sub>A</sub> = -40°C to +85°C		Units
				Typ.	Guaranteed Limits			
V <sub>IH</sub>	Minimum HIGH Level Input Voltage	4.5	V <sub>OUT</sub> = 0.1V or V <sub>CC</sub> - 0.1V	1.5	2.0	2.0		V
		5.5		1.5	2.0	2.0		
V <sub>IL</sub>	Maximum LOW Level Input Voltage	4.5	V <sub>OUT</sub> = 0.1V or V <sub>CC</sub> - 0.1V	1.5	0.8	0.8		V
		5.5		1.5	0.8	0.8		
V <sub>OH</sub>	Minimum HIGH Level Output Voltage	4.5	I <sub>OUT</sub> = -50μA	4.49	4.34	4.4		V
		5.5		5.49	5.4	5.4		
		4.5	V <sub>IN</sub> = V <sub>IL</sub> or V <sub>IH</sub> , I <sub>OH</sub> = -24mA		3.86	3.76		
		5.5		V <sub>IN</sub> = V <sub>IL</sub> or V <sub>IH</sub> , I <sub>OH</sub> = -24mA <sup>(4)</sup>		4.86	4.76	
V <sub>OL</sub>	Maximum LOW Level Output Voltage	4.5	I <sub>OUT</sub> = 50μA	0.001	0.1	0.1		V
		5.5		0.001	0.1	0.1		
		4.5	V <sub>IN</sub> = V <sub>IL</sub> or V <sub>IH</sub> , I <sub>OL</sub> = 24mA		0.36	0.44		
		5.5		V <sub>IN</sub> = V <sub>IL</sub> or V <sub>IH</sub> , I <sub>OL</sub> = 24mA <sup>(4)</sup>		0.36	0.44	
I <sub>IN</sub>	Maximum Input Leakage Current	5.5	V <sub>I</sub> = V <sub>CC</sub> , GND		±0.1	±1.0		μA
V <sub>H(MAX)</sub>	Maximum Hysteresis	4.5	T <sub>A</sub> = Worst Case		1.4	1.4		V
		5.5			1.6	1.6		
V <sub>H(MIN)</sub>	Minimum Hysteresis	4.5	T <sub>A</sub> = Worst Case		0.4	0.4		V
		5.5			0.5	0.5		
V <sub>t+</sub>	Maximum Positive Threshold	4.5	T <sub>A</sub> = Worst Case		2.0	2.0		V
		5.5			2.0	2.0		
V <sub>t-</sub>	Minimum Negative Threshold	4.5	T <sub>A</sub> = Worst Case		0.8	0.8		V
		5.5			0.8	0.8		
I <sub>CCT</sub>	Maximum I <sub>CC</sub> /Input	5.5	V <sub>I</sub> = V <sub>CC</sub> - 2.1V	0.6		1.5		mA
I <sub>OLD</sub>	Minimum Dynamic Output Current <sup>(5)</sup>	5.5	V <sub>OLD</sub> = 1.65V Max.			75		mA
I <sub>OHD</sub>		5.5	V <sub>OHD</sub> = 3.85V Min.			-75		mA
I <sub>CC</sub>	Maximum Quiescent Supply Current	5.5	V <sub>IN</sub> = V <sub>CC</sub> or GND		2.0	20.0		μA

**Notes:**

- All outputs loaded; thresholds on input associated with output under test.
- Maximum test duration 2.0ms, one output loaded at a time.

**AC Electrical Characteristics for AC**

Symbol	Parameter	$V_{CC}$ (V) <sup>(6)</sup>	$T_A = +25^\circ\text{C}$ , $C_L = 50\text{pF}$			$T_A = -40^\circ\text{C to } +85^\circ\text{C}$ , $C_L = 50\text{pF}$		Units
			Min.	Typ.	Max.	Min.	Max.	
$t_{PLH}$	Propagation Delay	3.3	1.5	9.5	13.5	1.5	15.0	ns
		5.0	1.5	7.0	10.0	1.5	11.0	
$t_{PHL}$	Propagation Delay	3.3	1.5	7.5	11.5	1.5	13.0	ns
		5.0	1.5	6.0	8.5	1.5	9.5	

**Note:**

6. Voltage range 3.3 is  $3.3\text{V} \pm 0.3\text{V}$ . Voltage range 5.0 is  $5.0\text{V} \pm 0.5\text{V}$ .

**AC Electrical Characteristics for ACT**

Symbol	Parameter	$V_{CC}$ (V) <sup>(7)</sup>	$T_A = +25^\circ\text{C}$ , $C_L = 50\text{pF}$			$T_A = -40^\circ\text{C to } +85^\circ\text{C}$ , $C_L = 50\text{pF}$		Units
			Min.	Typ.	Max.	Min.	Max.	
$t_{PLH}$	Propagation Delay	5.0	3.0	8.0	10.0	3.0	11.0	ns
$t_{PHL}$	Propagation Delay	5.0	3.0	8.0	10.0	3.0	11.0	ns

**Note:**

7. Voltage Range 5.0 is  $5.0\text{V} \pm 0.5\text{V}$ .

**Capacitance**

Symbol	Parameter	Conditions	Typ	Units
$C_{IN}$	Input Capacitance	$V_{CC} = \text{OPEN}$	4.5	pF
$C_{PD}$	Power Dissipation Capacitance	$V_{CC} = 5.0\text{V}$	25.0	pF
	AC			
	ACT		80	

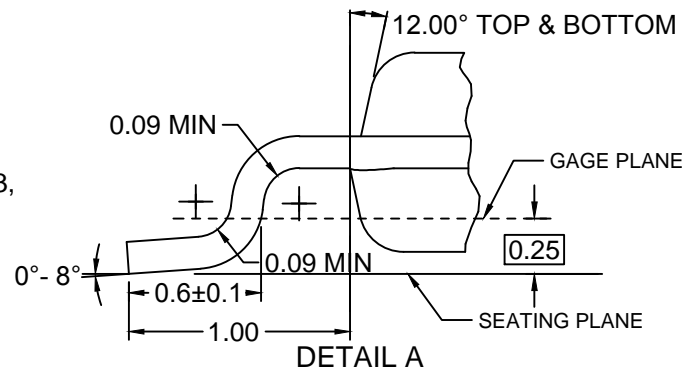
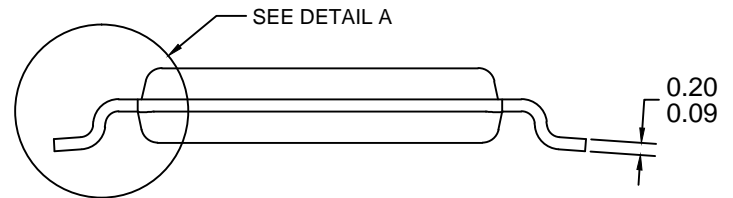
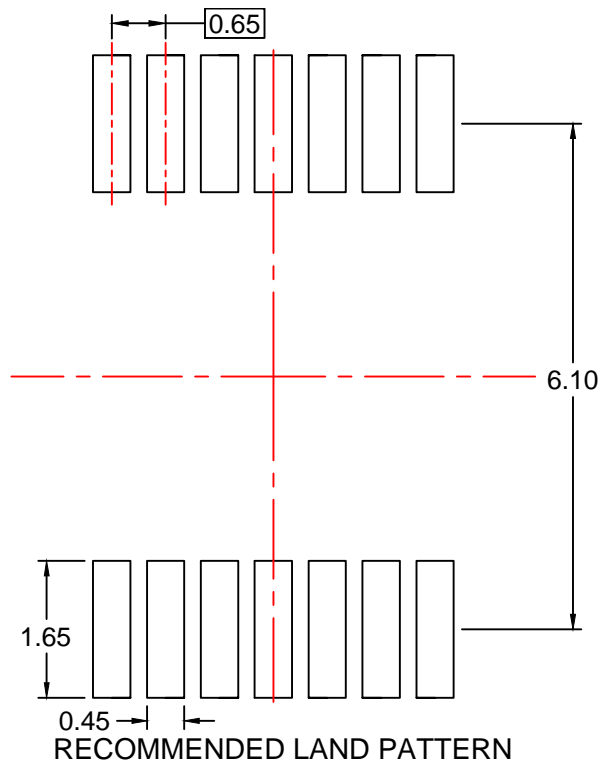

NOTES:

- A. CONFORMS TO JEDEC REGISTRATION MO-153, VARIATION AB, REF NOTE 6
- B. DIMENSIONS ARE IN MILLIMETERS.
- C. DIMENSIONS ARE EXCLUSIVE OF BURRS, MOLD FLASH, AND TIE BAR EXTRUSIONS
- D. DIMENSIONING AND TOLERANCES PER ANSI Y14.5M, 2009.
- E. LANDPATTERN STANDARD: SOP65P640X110-14M.
- F. DRAWING FILE NAME: MKT-MTC14rev7.





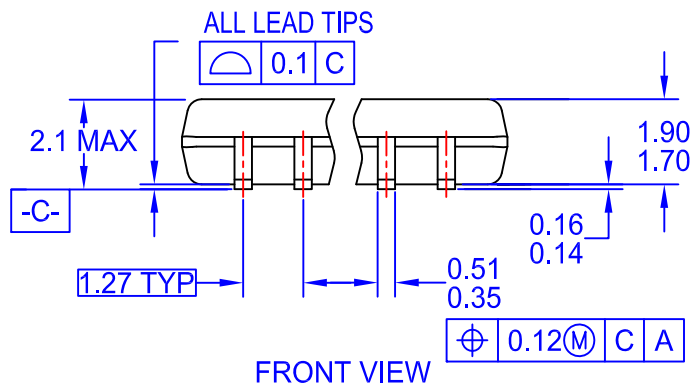

- NOTES:
- A. CONFORMS TO EIAJ EDR-7320 REGISTRATION, ESTABLISHED IN DECEMBER, 1998.
  - B. DIMENSIONS ARE IN MILLIMETERS.
  - C. DIMENSIONS ARE EXCLUSIVE OF BURRS, MOLD FLASH, AND TIE BAR EXTRUSIONS.
  - D. DRAWING FILENAME: MKT-M14Drev4.

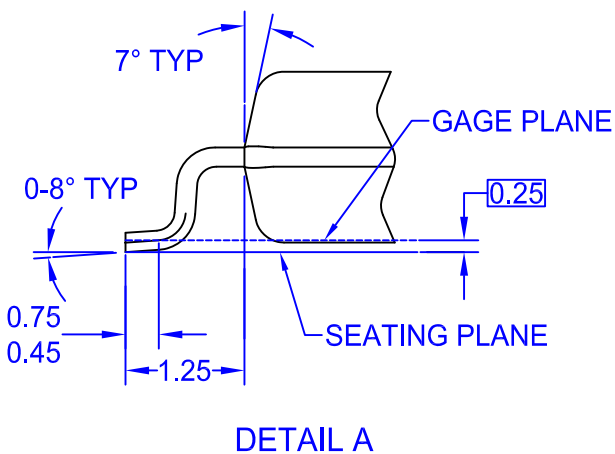

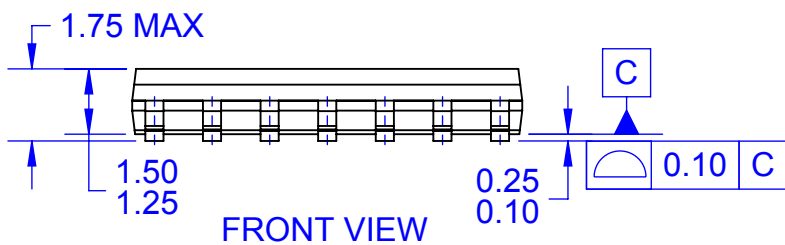
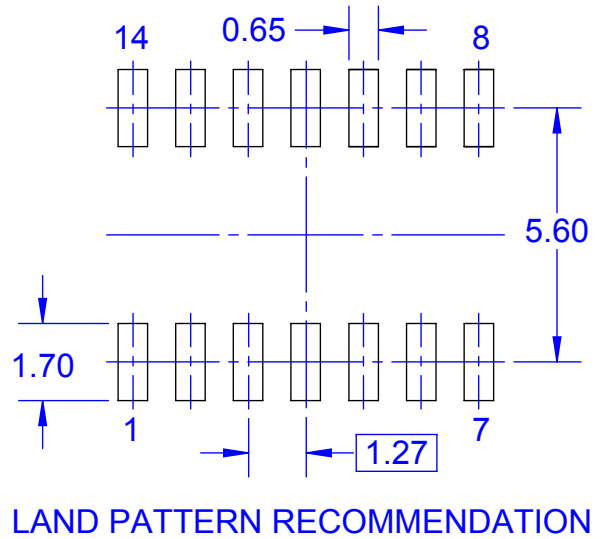
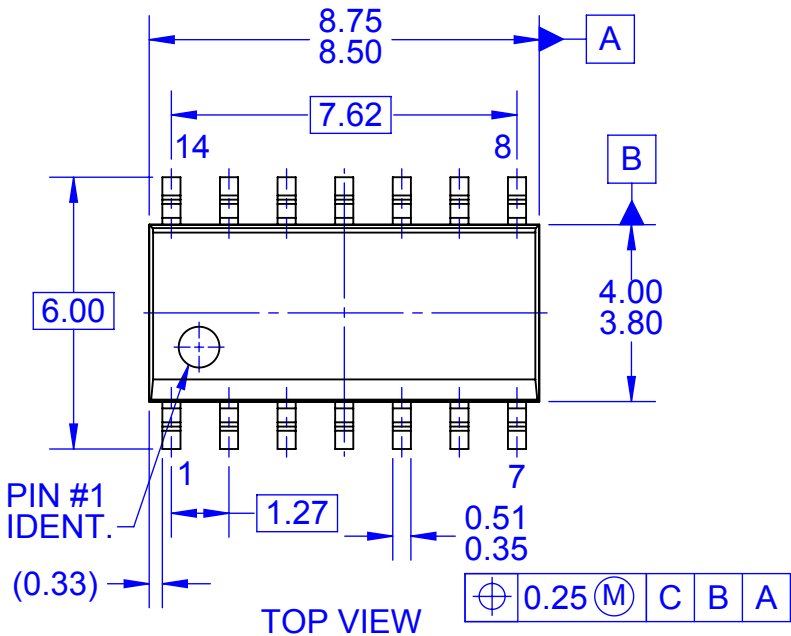

NOTES:

- A. CONFORMS TO JEDEC MS-012, VARIATION AB, ISSUE C
- B. ALL DIMENSIONS ARE IN MILLIMETERS
- C. DIMENSIONS DO NOT INCLUDE MOLD FLASH OR BURRS
- D. LAND PATTERN STANDARD: SOIC127P600X145-14M
- E. CONFORMS TO ASME Y14.5M, 2009
- D. DRAWING FILENAME: MKT-M14Arev14



ON Semiconductor and  are trademarks of Semiconductor Components Industries, LLC dba ON Semiconductor or its subsidiaries in the United States and/or other countries. ON Semiconductor owns the rights to a number of patents, trademarks, copyrights, trade secrets, and other intellectual property. A listing of ON Semiconductor's product/patent coverage may be accessed at [www.onsemi.com/site/pdf/Patent-Marking.pdf](http://www.onsemi.com/site/pdf/Patent-Marking.pdf). ON Semiconductor reserves the right to make changes without further notice to any products herein. ON Semiconductor makes no warranty, representation or guarantee regarding the suitability of its products for any particular purpose, nor does ON Semiconductor assume any liability arising out of the application or use of any product or circuit, and specifically disclaims any and all liability, including without limitation special, consequential or incidental damages. Buyer is responsible for its products and applications using ON Semiconductor products, including compliance with all laws, regulations and safety requirements or standards, regardless of any support or applications information provided by ON Semiconductor. "Typical" parameters which may be provided in ON Semiconductor data sheets and/or specifications can and do vary in different applications and actual performance may vary over time. All operating parameters, including "Typicals" must be validated for each customer application by customer's technical experts. ON Semiconductor does not convey any license under its patent rights nor the rights of others. ON Semiconductor products are not designed, intended, or authorized for use as a critical component in life support systems or any FDA Class 3 medical devices or medical devices with a same or similar classification in a foreign jurisdiction or any devices intended for implantation in the human body. Should Buyer purchase or use ON Semiconductor products for any such unintended or unauthorized application, Buyer shall indemnify and hold ON Semiconductor and its officers, employees, subsidiaries, affiliates, and distributors harmless against all claims, costs, damages, and expenses, and reasonable attorney fees arising out of, directly or indirectly, any claim of personal injury or death associated with such unintended or unauthorized use, even if such claim alleges that ON Semiconductor was negligent regarding the design or manufacture of the part. ON Semiconductor is an Equal Opportunity/Affirmative Action Employer. This literature is subject to all applicable copyright laws and is not for resale in any manner.

## PUBLICATION ORDERING INFORMATION

### LITERATURE FULFILLMENT:

Literature Distribution Center for ON Semiconductor  
19521 E. 32nd Pkwy, Aurora, Colorado 80011 USA  
**Phone:** 303-675-2175 or 800-344-3860 Toll Free USA/Canada  
**Fax:** 303-675-2176 or 800-344-3867 Toll Free USA/Canada  
**Email:** [orderlit@onsemi.com](mailto:orderlit@onsemi.com)

**N. American Technical Support:** 800-282-9855 Toll Free  
USA/Canada  
**Europe, Middle East and Africa Technical Support:**  
Phone: 421 33 790 2910  
**Japan Customer Focus Center**  
Phone: 81-3-5817-1050

**ON Semiconductor Website:** [www.onsemi.com](http://www.onsemi.com)  
**Order Literature:** <http://www.onsemi.com/orderlit>  
For additional information, please contact your local  
Sales Representative

# Mouser Electronics

Authorized Distributor

Click to View Pricing, Inventory, Delivery & Lifecycle Information:

[ON Semiconductor:](#)

[74AC14MTCX](#) [74AC14MTC](#) [74AC14SCX](#) [74AC14SJX](#) [74AC14PC](#) [74AC14SC](#) [74AC14SJ](#)

Компания «Life Electronics» занимается поставками электронных компонентов импортного и отечественного производства от производителей и со складов крупных дистрибьюторов Европы, Америки и Азии.

С конца 2013 года компания активно расширяет линейку поставок компонентов по направлению коаксиальный кабель, кварцевые генераторы и конденсаторы (керамические, пленочные, электролитические), за счёт заключения дистрибьюторских договоров

Мы предлагаем:

- Конкуренспособные цены и скидки постоянным клиентам.
- Специальные условия для постоянных клиентов.
- Подбор аналогов.
- Поставку компонентов в любых объемах, удовлетворяющих вашим потребностям.
- Приемлемые сроки поставки, возможна ускоренная поставка.
- Доставку товара в любую точку России и стран СНГ.
- Комплексную поставку.
- Работу по проектам и поставку образцов.
- Формирование склада под заказчика.
- Сертификаты соответствия на поставляемую продукцию (по желанию клиента).
- Тестирование поставляемой продукции.
- Поставку компонентов, требующих военную и космическую приемку.
- Входной контроль качества.
- Наличие сертификата ISO.

В составе нашей компании организован Конструкторский отдел, призванный помогать разработчикам, и инженерам.

Конструкторский отдел помогает осуществить:

- Регистрацию проекта у производителя компонентов.
- Техническую поддержку проекта.
- Защиту от снятия компонента с производства.
- Оценку стоимости проекта по компонентам.
- Изготовление тестовой платы монтаж и пусконаладочные работы.



Тел: +7 (812) 336 43 04 (многоканальный)

Email: [org@lifeelectronics.ru](mailto:org@lifeelectronics.ru)