



**PICkitTM Serial Analyzer
USER'S GUIDE**

Note the following details of the code protection feature on Microchip devices:

- Microchip products meet the specification contained in their particular Microchip Data Sheet.
- Microchip believes that its family of products is one of the most secure families of its kind on the market today, when used in the intended manner and under normal conditions.
- There are dishonest and possibly illegal methods used to breach the code protection feature. All of these methods, to our knowledge, require using the Microchip products in a manner outside the operating specifications contained in Microchip's Data Sheets. Most likely, the person doing so is engaged in theft of intellectual property.
- Microchip is willing to work with the customer who is concerned about the integrity of their code.
- Neither Microchip nor any other semiconductor manufacturer can guarantee the security of their code. Code protection does not mean that we are guaranteeing the product as "unbreakable."

Code protection is constantly evolving. We at Microchip are committed to continuously improving the code protection features of our products. Attempts to break Microchip's code protection feature may be a violation of the Digital Millennium Copyright Act. If such acts allow unauthorized access to your software or other copyrighted work, you may have a right to sue for relief under that Act.

Information contained in this publication regarding device applications and the like is provided only for your convenience and may be superseded by updates. It is your responsibility to ensure that your application meets with your specifications. MICROCHIP MAKES NO REPRESENTATIONS OR WARRANTIES OF ANY KIND WHETHER EXPRESS OR IMPLIED, WRITTEN OR ORAL, STATUTORY OR OTHERWISE, RELATED TO THE INFORMATION, INCLUDING BUT NOT LIMITED TO ITS CONDITION, QUALITY, PERFORMANCE, MERCHANTABILITY OR FITNESS FOR PURPOSE. Microchip disclaims all liability arising from this information and its use. Use of Microchip devices in life support and/or safety applications is entirely at the buyer's risk, and the buyer agrees to defend, indemnify and hold harmless Microchip from any and all damages, claims, suits, or expenses resulting from such use. No licenses are conveyed, implicitly or otherwise, under any Microchip intellectual property rights.

Trademarks

The Microchip name and logo, the Microchip logo, Accuron, dsPIC, KEELOQ, KEELOQ logo, microID, MPLAB, PIC, PICmicro, PICSTART, PRO MATE, PowerSmart, rfPIC, and SmartShunt are registered trademarks of Microchip Technology Incorporated in the U.S.A. and other countries.

AmpLab, FilterLab, Linear Active Thermistor, Migratable Memory, MXDEV, MXLAB, PS logo, SEEVAL, SmartSensor and The Embedded Control Solutions Company are registered trademarks of Microchip Technology Incorporated in the U.S.A.

Analog-for-the-Digital Age, Application Maestro, CodeGuard, dsPICDEM, dsPICDEM.net, dsPICworks, ECAN, ECONOMONITOR, FanSense, FlexROM, fuzzyLAB, In-Circuit Serial Programming, ICSP, ICEPIC, Mindi, MiWi, MPASM, MPLAB Certified logo, MPLIB, MPLINK, PICkit, PICDEM, PICDEM.net, PICLAB, PICtail, PowerCal, PowerInfo, PowerMate, PowerTool, REAL ICE, rLAB, rfPICDEM, Select Mode, Smart Serial, SmartTel, Total Endurance, UNI/O, WiperLock and ZENA are trademarks of Microchip Technology Incorporated in the U.S.A. and other countries.

SQTP is a service mark of Microchip Technology Incorporated in the U.S.A.

All other trademarks mentioned herein are property of their respective companies.

© 2007, Microchip Technology Incorporated, Printed in the U.S.A., All Rights Reserved.

 Printed on recycled paper.

Microchip received ISO/TS-16949:2002 certification for its worldwide headquarters, design and wafer fabrication facilities in Chandler and Tempe, Arizona, Gresham, Oregon and Mountain View, California. The Company's quality system processes and procedures are for its PIC[®] MCUs and dsPIC[®] DSCs, KEELOQ[®] code hopping devices, Serial EEPROMs, microperipherals, nonvolatile memory and analog products. In addition, Microchip's quality system for the design and manufacture of development systems is ISO 9001:2000 certified.

**QUALITY MANAGEMENT SYSTEM
CERTIFIED BY DNV
== ISO/TS 16949:2002 ==**

Table of Contents

Preface	1
Chapter 1. PICKit™ Serial Analyzer Overview	
1.1 Introduction	5
1.2 Highlights	5
1.3 PICKit™ Serial Analyzer Contents	5
1.4 PICKit™ Serial Analyzer Development System	5
1.5 PICKit™ Serial Analyzer Hardware	6
1.6 PICKit™ Serial Analyzer Software	8
Chapter 2. Getting Started	
2.1 Introduction	9
2.2 Highlights	9
2.3 Installing the PICKit™ Serial Analyzer Software	9
2.4 Connecting the PICKit™ Serial Analyzer to the PC	9
2.5 Connecting the PICKit™ Serial Analyzer to the 28-Pin Demo Board	10
2.6 Starting the PICKit™ Serial Analyzer Program	10
2.7 Running the 28-Pin Demo I ² C™ Demonstration Program	11
2.8 I ² C™ Communications – Basic Operations	14
2.9 28-Pin Demo I ² C™ Source Code and Firmware	15
Chapter 3. PICKit™ Serial Analyzer PC Program	
3.1 Introduction	17
3.2 Highlights	17
3.3 Installing the PICKit™ Serial Analyzer Software	17
3.4 Starting the Program	17
3.5 Configuration Wizard	18
3.6 Main Window	21
3.7 Serial Communications Modes	25

PICKit™ Serial Analyzer User's Guide

Chapter 4. I²C™ Master Communications

4.1	Introduction	27
4.2	Highlights	27
4.3	PICKit Serial Pin Assignments	27
4.4	Selecting Communications Mode	27
4.5	Configuring I ² C Communications Mode	28
4.6	Communications: Basic Operations	30
4.7	Script Builder	31
4.8	Script Execute	35

Chapter 5. SPI Master Communications

5.1	Introduction	37
5.2	Highlights	37
5.3	PICKit™ Serial Analyzer Pin Assignments	37
5.4	Selecting Communications Mode	37
5.5	Configuring SPI Communications Mode	38
5.6	Communications: Basic Operations	40
5.7	Script Builder	42
5.8	Script Execute	46

Chapter 6. USART Asynchronous Communications

6.1	Introduction	49
6.2	Highlights	49
6.3	PICKit Serial Pin Assignments	49
6.4	Selecting Communications Mode	50
6.5	Configuring USART Asynchronous Communications Mode	50
6.6	Communications: Basic Operations	52
6.7	Script Builder	52
6.8	Script Execute	57

Chapter 7. USART Master Synchronous Communications

7.1	Introduction	59
7.2	Highlights	59

Table of Contents

7.3	PICKit Serial Pin Assignments	59
7.4	Selecting Communications Mode	59
7.5	Configuring USART Synchronous Master Communications Mode	60
7.6	Communications: Basic Operations	62
7.7	Script Builder	62
7.8	Script Execute	67
Chapter 8. User Defined Templates		
8.1	Introduction	69
8.2	Highlights	69
8.3	Create Templates	69
8.4	My Templates	71
Chapter 9. PICKit™ Serial Analyzer Firmware		
9.1	Introduction	73
9.2	Highlights	73
9.3	Overview	73
9.4	EXEC	75
9.5	COMM	78
9.6	I ² CM Communications	82
9.7	SPI Communications	87
9.8	USART Communications	90
Chapter 10. PICKit™ Serial Analyzer DLL		
10.1	Introduction	95
10.2	Highlights	95
10.3	Summary of Functions	95
10.4	Programming Example	99

PICkit™ Serial Analyzer User's Guide

Chapter 11. Troubleshooting

11.1	Introduction	101
11.2	Frequently Asked Questions	101

Appendix A. PICkit Serial Analyzer Schematics 103

A.1	Introduction	103
-----	--------------------	-----

Appendix B. 28-Pin Demo Board I²C™ Demonstration Firmware ... 107

B.1	Introduction	107
B.2	Highlights	107
B.3	Hardware	107
B.4	Firmware	107
B.5	I ² C Communications	108
B.6	Slave Devices	109
B.7	Functions	112

Worldwide Sales and Service 114

Preface

NOTICE TO CUSTOMERS

All documentation becomes dated, and this manual is no exception. Microchip tools and documentation are constantly evolving to meet customer needs, so some actual dialogs and/or tool descriptions may differ from those in this document. Please refer to our web site (www.microchip.com) to obtain the latest documentation available.

Documents are identified with a “DS” number. This number is located on the bottom of each page, in front of the page number. The numbering convention for the DS number is “DSXXXXA”, where “XXXX” is the document number and “A” is the revision level of the document.

For the most up-to-date information on development tools, see the MPLAB® IDE on-line help. Select the Help menu, and then Topics to open a list of available on-line help files.

INTRODUCTION

This chapter contains general information that will be useful to know before using the PICKit™ Serial Analyzer User's Guide. Items discussed in this chapter include:

- Document Layout
- Conventions Used in this Guide
- Warranty Registration
- Recommended Reading
- The Microchip Web Site
- Development Systems Customer Change Notification Service
- Customer Support
- Document Revision History

DOCUMENT LAYOUT

This document describes how to use the PICKit™ Serial Analyzer as a development tool to communicate with embedded development systems via serial protocols. The manual layout is as follows:

- **Chapter 1: PICKit™ Serial Analyzer Overview**
- **Chapter 2: Getting Started**
- **Chapter 3: PICKit™ Serial Analyzer PC Program**
- **Chapter 4: I²C™ Master Communications**
- **Chapter 5: SPI Master Communications**
- **Chapter 6: USART Asynchronous Communications**
- **Chapter 7: USART Master Synchronous Communications**
- **Chapter 8: User Defined Templates**
- **Chapter 9: PICKit™ Serial Analyzer Firmware**
- **Chapter 10: PICKit™ Serial Analyzer DLL**

PICkit™ Serial Analyzer User's Guide

- Chapter 11: Troubleshooting
- Appendix A: Hardware Schematics
- Appendix B: 28-Pin Demo Board I²C™ Demo Firmware

CONVENTIONS USED IN THIS GUIDE

This manual uses the following documentation conventions:

DOCUMENTATION CONVENTIONS

Description	Represents	Examples
Arial font:		
Italic characters	Referenced books	<i>MPLAB® IDE User's Guide</i>
	Emphasized text	...is the <i>only</i> compiler...
Initial caps	A window	the Output window
	A dialog	the Settings dialog
	A menu selection	select Enable Programmer
Quotes	A field name in a window or dialog	"Save project before build"
Underlined, italic text with right angle bracket	A menu path	<u><i>File>Save</i></u>
Bold characters	A dialog button	Click OK
	A tab	Click the Power tab
N'Rnnnn	A number in verilog format, where N is the total number of digits, R is the radix and n is a digit.	4'b0010, 2'hF1
Text in angle brackets < >	A key on the keyboard	Press <Enter>, <F1>
Courier New font:		
Plain Courier New	Sample source code	#define START
	Filenames	autoexec.bat
	File paths	c:\mcc18\h
	Keywords	_asm, _endasm, static
	Command-line options	-Opa+, -Opa-
	Bit values	0, 1
	Constants	0xFF, 'A'
Italic Courier New	A variable argument	<i>file.o</i> , where <i>file</i> can be any valid filename
Square brackets []	Optional arguments	mcc18 [options] <i>file</i> [options]
Curly brackets and pipe character: { }	Choice of mutually exclusive arguments; an OR selection	errorlevel {0 1}
Ellipses...	Replaces repeated text	var_name [, var_name...]
	Represents code supplied by user	void main (void) { ... }

WARRANTY REGISTRATION

Please complete the enclosed Warranty Registration Card and mail it promptly. Sending in the Warranty Registration Card entitles users to receive new product updates. Interim software releases are available at the Microchip web site.

RECOMMENDED READING

This user's guide describes how to use the PICkit™ Serial Analyzer. Other useful documents are listed below. The following Microchip documents are available and recommended as supplemental reference resources.

Readme Files

For the latest information on using other tools, read the tool-specific Readme files in the Readmes subdirectory of the MPLAB IDE installation directory. The Readme files contain update information and known issues that may not be included in this user's guide.

THE MICROCHIP WEB SITE

Microchip provides online support via our web site at www.microchip.com. This web site is used as a means to make files and information easily available to customers. Accessible by using your favorite Internet browser, the web site contains the following information:

- **Product Support** – Data sheets and errata, application notes and sample programs, design resources, user's guides and hardware support documents, latest software releases and archived software
- **General Technical Support** – Frequently Asked Questions (FAQs), technical support requests, online discussion groups, Microchip consultant program member listing
- **Business of Microchip** – Product selector and ordering guides, latest Microchip press releases, listing of seminars and events, listings of Microchip sales offices, distributors and factory representatives

DEVELOPMENT SYSTEMS CUSTOMER CHANGE NOTIFICATION SERVICE

Microchip's customer notification service helps keep customers current on Microchip products. Subscribers will receive e-mail notification whenever there are changes, updates, revisions or errata related to a specified product family or development tool of interest.

To register, access the Microchip web site at www.microchip.com, click on Customer Change Notification and follow the registration instructions.

The Development Systems product group categories are:

- **Compilers** – The latest information on Microchip C compilers and other language tools. These include the MPLAB® C18 and MPLAB C30 C compilers; MPASM™ and MPLAB ASM30 assemblers; MPLINK™ and MPLAB LINK30 object linkers; and MPLIB™ and MPLAB LIB30 object librarians.
- **Emulators** – The latest information on Microchip in-circuit emulators. This includes the MPLAB ICE 2000 and MPLAB ICE 4000.
- **In-Circuit Debuggers** – The latest information on the Microchip in-circuit debugger, MPLAB ICD 2.
- **MPLAB® IDE** – The latest information on Microchip MPLAB IDE, the Windows® Integrated Development Environment for development systems tools. This list is focused on the MPLAB IDE, MPLAB SIM simulator, MPLAB IDE Project Manager

PICkit™ Serial Analyzer User's Guide

and general editing and debugging features.

- **Programmers** – The latest information on Microchip programmers. These include the MPLAB PM3 and PRO MATE® II device programmers and the PICSTART® Plus and PICkit™ 2 development programmers.

CUSTOMER SUPPORT

Users of Microchip products can receive assistance through several channels:

- Distributor or Representative
- Local Sales Office
- Field Application Engineer (FAE)
- Technical Support

Customers should contact their distributor, representative or field application engineer (FAE) for support. Local sales offices are also available to help customers. A listing of sales offices and locations is included in the back of this document.

Technical support is available through the web site at: <http://support.microchip.com>

DOCUMENT REVISION HISTORY

Revision A (January 2007)

- Initial release of this document.

Chapter 1. PICKit™ Serial Analyzer Overview

1.1 INTRODUCTION

The PICKit™ Serial Analyzer development system enables a personal computer (PC) to communicate with embedded development systems via serial protocols such as I²C™, SPI, asynchronous and synchronous USART. The PC program uses a graphical interface to enter data and commands to communicate to the target device. Data and commands can be entered using basic or scripting commands. The PICKit™ Serial Analyzer connects to the embedded development system using a 6-pin header.

The PICKit™ Serial Analyzer is a sophisticated and highly configurable device. Please take a few moments to familiarize yourself with the hardware interface and PC program by reading this user's guide. **Chapter 2. "Getting Started"** will guide you through installing the PC program and running a simple demonstration program on the 28-Pin Demo Board (DM164120-3) using the I²C serial protocol.

1.2 HIGHLIGHTS

This chapter discusses:

- PICKit™ Serial Analyzer Contents
- PICKit™ Serial Analyzer Development System
- PICKit™ Serial Analyzer Hardware
- PICKit™ Serial Analyzer PC Software

1.3 PICKit™ SERIAL ANALYZER CONTENTS

The PICKit™ Serial Analyzer serial communications development system contains the following items:

1. The PICKit™ Serial Analyzer
2. USB cable
3. PICKit™ Serial Analyzer CD-ROM

1.4 PICKit™ SERIAL ANALYZER DEVELOPMENT SYSTEM

The PICKit™ Serial Analyzer consists of several components that together make an embedded serial communications development system. The PC program runs on Microsoft® Windows® compatible computers with a USB port. The PICKit™ Serial Analyzer connects to the PC using a USB cable. Finally, the PICKit™ Serial Analyzer interfaces to the target device using a 6-pin header. Figure 1-1 illustrates the PICKit™ Serial Analyzer embedded serial communications development system.

PICKit™ Serial Analyzer User's Guide

FIGURE 1-1: PICKit™ SERIAL ANALYZER DEVELOPMENT SYSTEM

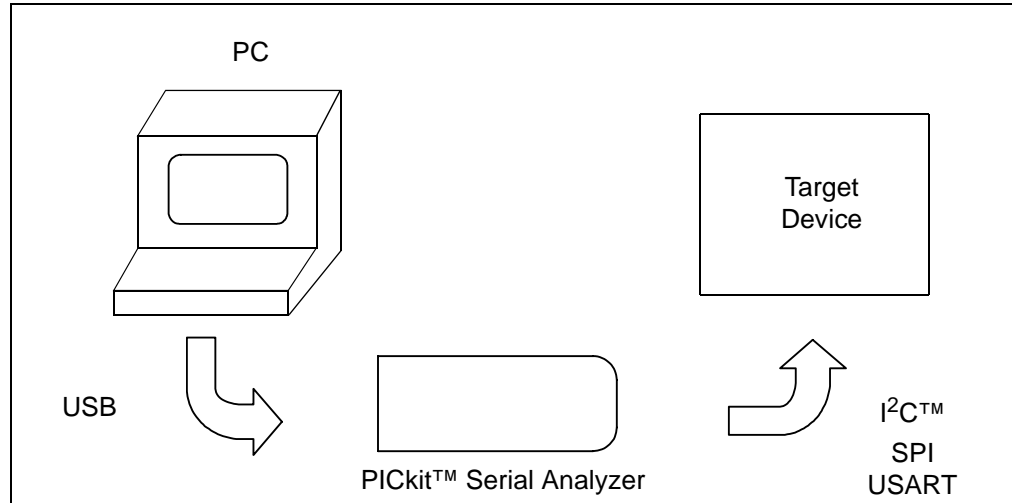

1.5 PICKit™ SERIAL ANALYZER HARDWARE

The PICKit™ Serial Analyzer connects to a Microsoft® Windows® compatible computer using a USB port. It interfaces to the target device using a 6-pin header. Figure 1-2 shows an overview of the PICKit™ Serial Analyzer.

FIGURE 1-2: PICKit™ SERIAL ANALYZER

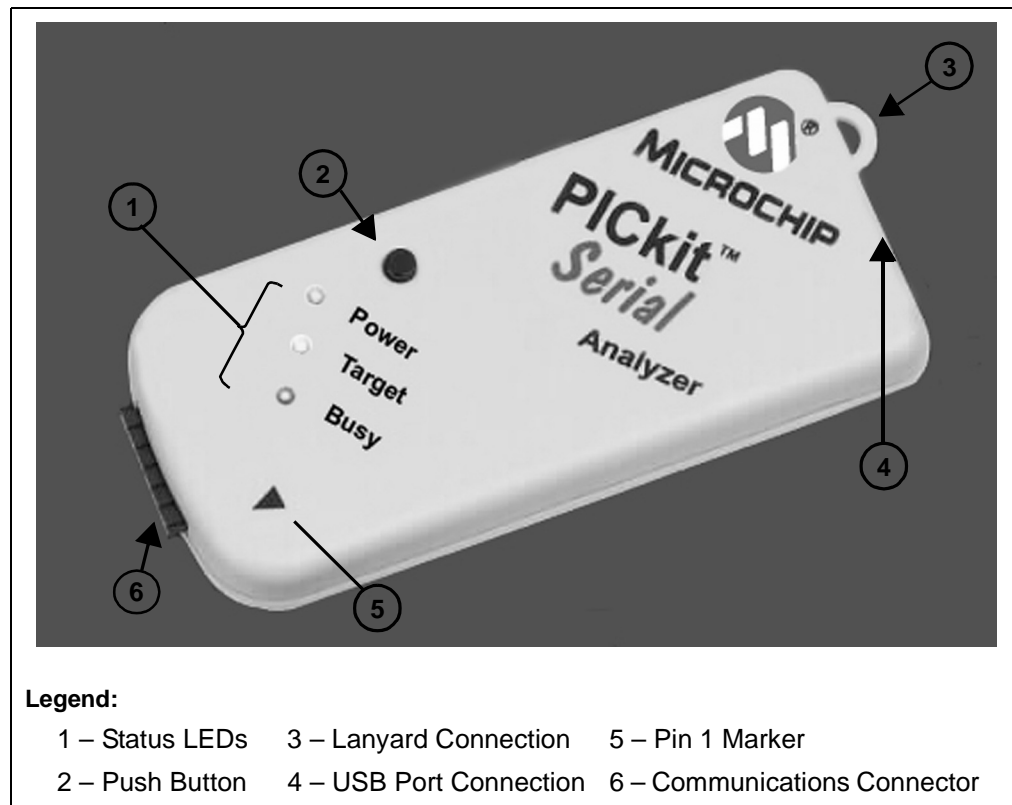

PICKit™ Serial Analyzer Overview

1.5.1 Status LEDs

The Status LEDs indicate the status of the PICKit™ Serial Analyzer.

1. Power (green) – Power is applied to the PICKit™ Serial Analyzer by the USB port.
2. Target (yellow) – The PICKit™ Serial Analyzer is communicating with the target device.
3. Busy (red) – The PICKit™ Serial Analyzer is communicating with the target device.

1.5.2 Push Button

The push button is available for future implementation.

1.5.3 Lanyard Connection

To help prevent possible loss of the PICKit™ Serial Analyzer, a convenient lanyard connection is available.

1.5.4 USB Port Connection

The USB Port Connection is a USB mini-B connector. Connect the PICKit™ Serial Analyzer to the PC using the supplied cable.

1.5.5 Pin 1 Marker

The Pin 1 marker assists in aligning the PICKit™ Serial Analyzer with the target device. Pin assignments are shown in Figure 1-3.

1.5.6 Communication Connector

The communication connector connects to the target device using an inexpensive 6-pin, 0.100" pitch spacing, 0.025" square pin header. Pin assignments are shown in Figure 1-3.

FIGURE 1-3: PICKit™ SERIAL ANALYZER PIN ASSIGNMENTS

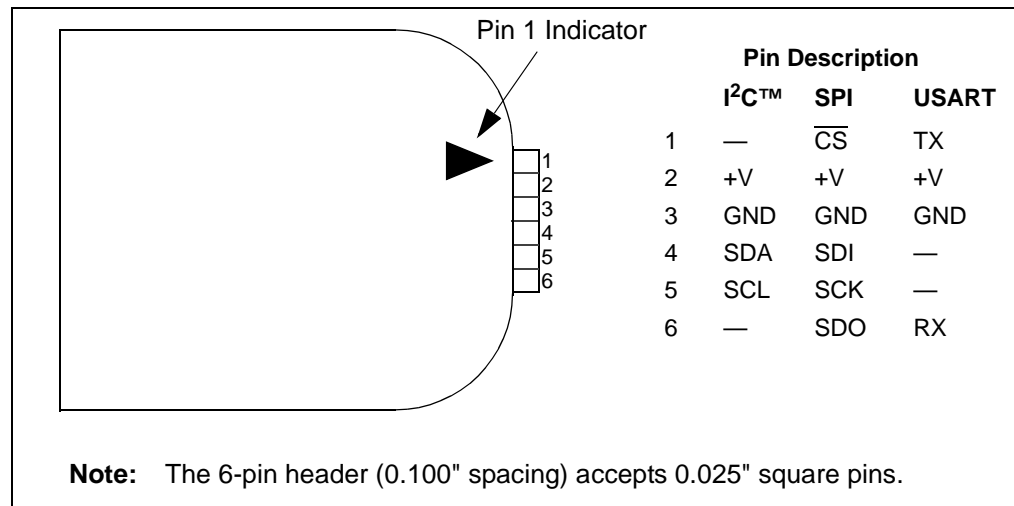

1.6 PICkit™ SERIAL ANALYZER SOFTWARE

1.6.1 PC Program

The PICkit™ Serial Analyzer PC program uses a graphical interface to enter data and commands to communicate to the target device. Data and commands can be entered using basic or scripting commands. **Chapter 3. “PICkit™ Serial Analyzer PC Program”** explains the installation and operation of the program. Following Chapter 3 there are individual chapters that explain the specific serial communications modes and their operation.

1.6.2 Dynamically Linked Library (DLL)

The PICkit™ Serial Analyzer DLL is explained in **Chapter 10. “PICkit™ Serial Analyzer DLL”**.

1.6.3 Firmware

The PICkit™ Serial Analyzer firmware is explained in **Chapter 9. “PICkit™ Serial Analyzer Firmware”**.

The latest version of the PICkit™ Serial Analyzer firmware can be downloaded from the Microchip Technology web site. The firmware is updated by selecting *PICkit Serial Analyzer > Download PICkit Serial Analyzer Firmware* from the menu bar. An open file window will open. Select the *.hex file to be uploaded to the PICkit™ Serial Analyzer and click on the **Open** button. The Firmware Download window will open as shown in Figure 1-4 to indicate the status of the firmware update.

FIGURE 1-4: FIRMWARE DOWNLOAD WINDOW

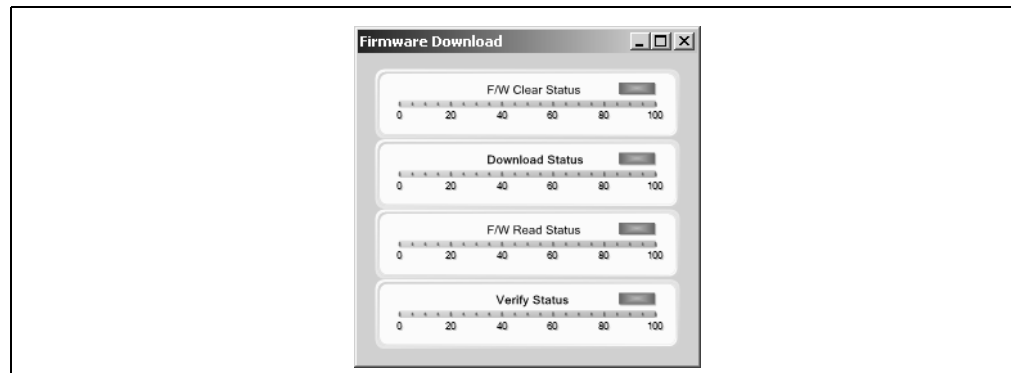

Chapter 2. Getting Started

2.1 INTRODUCTION

This chapter will get you started using the PICKit™ Serial Analyzer with the 28-Pin Demo Board. In this demo, the PICKit™ Serial Analyzer will communicate with the 28-Pin Demo Board using the I²C serial protocol. The PICKit™ Serial Analyzer will be the I²C Master and the 28-Pin Demo Board will be the I²C Slave device. The 28-Pin Demo board is programmed to emulate an I²C real-time clock and Serial EEPROM. For more information about the 28-Pin Demo Board hardware, see the **28-Pin Demo Board User's Guide** (DS41301).

For more information about the 28-Pin Demo Board I²C™ demo firmware, see **Appendix B. "28-Pin Demo Board I²C™ Demonstration Firmware"**.

The demo program source code and *.hex file can be found on the PICKit™ Serial CD-ROM at D:\28-pin Demo Board\Firmware\.

2.2 HIGHLIGHTS

This chapter discusses:

- Installing the PICKit™ Serial Analyzer Software
- Connecting the PICKit Serial Analyzer to the PC
- Connecting the PICKit Serial Analyzer to the 28-Pin Demo Board
- Starting the PICKit Serial Analyzer Program
- Running The 28-Pin Demo I²C™ Demonstration Program
- I²C Communications – Basic Operations
- 28-Pin Demo I²C™ Source Code and Firmware

2.3 INSTALLING THE PICKit™ SERIAL ANALYZER SOFTWARE

Insert the PICKit™ Serial Analyzer CD-ROM into the CD-ROM drive. In a few moments the introductory screen should be displayed. Follow the directions on the screen to install the PICKit Serial Analyzer software.

If the introductory screen does not appear, browse to the CD-ROM directory and select the AutorunPro.exe program.

Note: The PICKit™ Serial Analyzer program requires the Microsoft® .NET Framework Version 2.0. If the .NET Framework is not installed on your computer (or if in doubt), select the application plus Microsoft® .NET Framework installation.

2.4 CONNECTING THE PICKit™ SERIAL ANALYZER TO THE PC

Connect the PICKit Serial Analyzer to the PC using the supplied USB cable. There are no USB drivers to install. The green Power indicator should light indicating that the PICKit Serial Analyzer is powered.

PICKit™ Serial Analyzer User's Guide

2.5 CONNECTING THE PICKit™ SERIAL ANALYZER TO THE 28-PIN DEMO BOARD

Connect the PICKit Serial Analyzer to P3 on the 28-Pin Demo Board as shown in Figure 2-1. The PICKit Serial Analyzer will supply power to the 28-Pin Demo Board and perform a power on routine:

- LEDs will flash in sequence DS1, DS2, DS3, DS4, DS3, DS2, and DS1 twice
- All LEDs will turn off
- All LEDs will turn on
- All LEDs will turn off
- LEDs will display in hexadecimal: A, D, C
- LEDs will display the top 4 bits of the ADC value read from potentiometer RP1

FIGURE 2-1: CONNECTING PICKit™ SERIAL TO THE 28-PIN DEMO BOARD

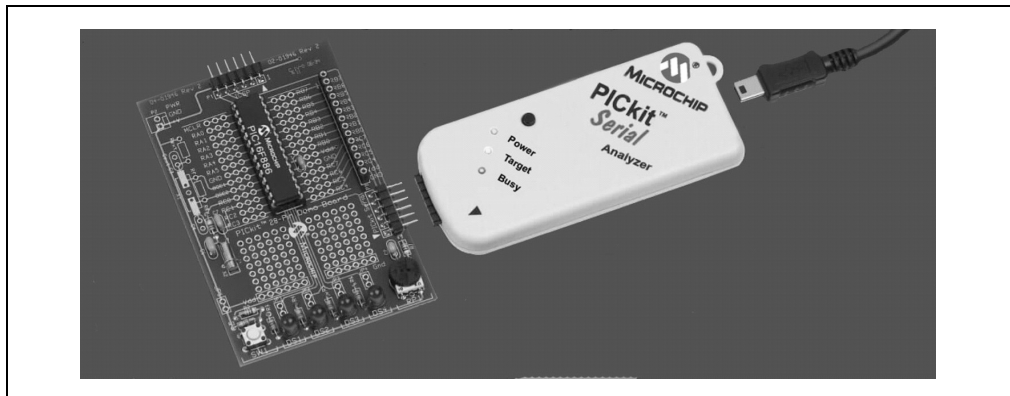

2.6 STARTING THE PICKit™ SERIAL ANALYZER PROGRAM

You can start the program by:

- Clicking on the desktop icon, or
- Navigating to *Start>All Programs>Microchip>PICKit Serial Analyzer*

After a few moments, the program will start and display the main window as shown in Figure 2-2.

If this is the first time you are running the program, the Configuration Wizard will automatically run. Click on the **Next** button and accept the default settings for I²C Master mode. For more information about using the I²C Master mode, see **Chapter 4. “I²C™ Master Communications.”**

FIGURE 2-2: PICKit™ SERIAL ANALYZER MAIN WINDOW

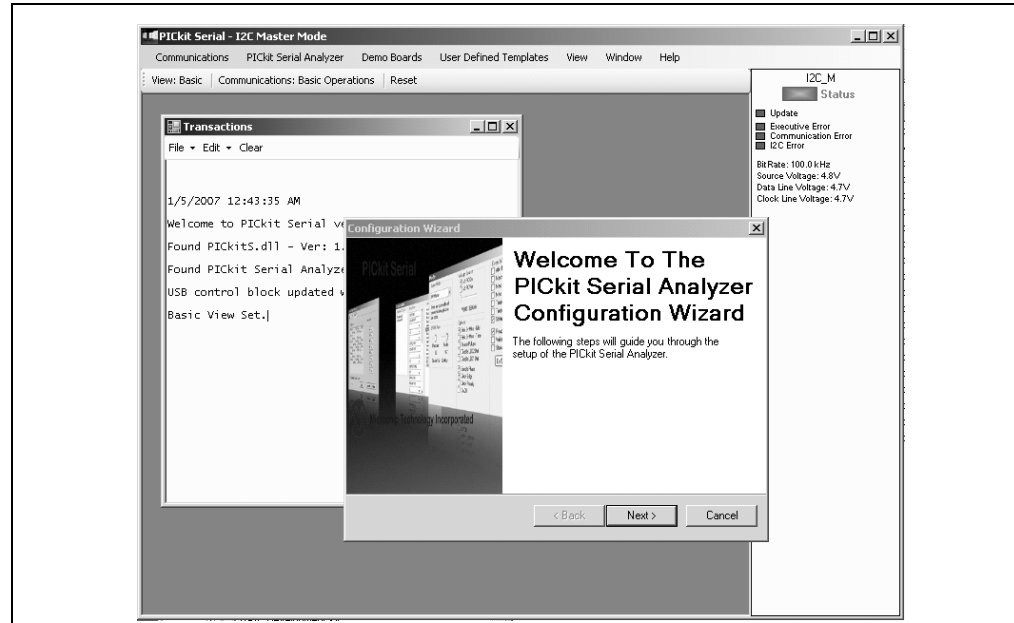

2.7 RUNNING THE 28-PIN DEMO I²C™ DEMONSTRATION PROGRAM

Select the 28-Pin Demo I²C demonstration by clicking on *Demo Boards > 28 Pin Demo I²C* from the menu bar. The 28-Pin Demo I²C demonstration window will be displayed as shown in Figure 2-3.

The Real-Time Clock (RTC) will be displayed first. Note the tabs to select between the RTC, EEPROM and ADC demonstrations. The demonstration program will constantly poll the 28-Pin Demo Board and display the contents of the real-time clock and the ADC.

2.7.1 Real-Time Clock (RTC)

Clicking on the **Real-Time Clock** tab will display calendar and clock contents of the real-time clock function running on the 28-Pin Demo Board. The 28-Pin Demo Board has been programmed to emulate a stand-alone serial I²C clock-calendar device. The I²C commands are very similar to the commands used in these devices. The demonstration program will constantly poll the 28-Pin Demo Board and display the contents of the real-time clock.

The Real-Time Clock window displays calendar and clock controls. Notice the date and time when the 28-Pin Demo Board has first been powered on. The date and time start at January 1, 2000 at midnight (12:00 AM).

The user can manually enter calendar and clock values and send the values to the real-time clock by clicking on the **Update RTC** button. Or the user can click on the **Set RTC to System Time** button to set the real-time clock to the date and time of the computer.

FIGURE 2-3: 28-PIN DEMO I²C™ – RTC

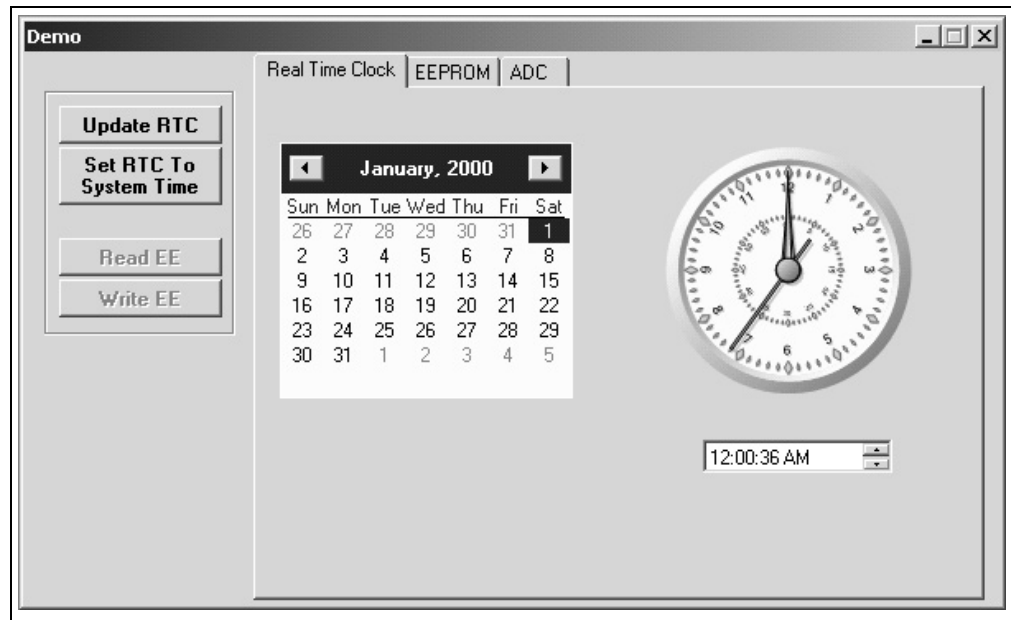

2.7.2 Serial EEPROM (EEPROM)

Clicking on the EEPROM tab will display the 256 byte array of EEPROM memory as shown in Figure 2-4. The 28-Pin Demo Board has been programmed to emulate a stand-alone serial I²C EEPROM device such as a 24LC02. The I²C commands are very similar to the commands used in these devices.

The Serial EEPROM tab displays the contents of a serial EEPROM implemented on the 28-Pin Demo Board. When this tab is first displayed, the values are grayed out. This means that the display does not match the contents of the emulated serial EEPROM. Click on **Read EE** button and the program will read and display the contents of the 28-Pin Demo Board. Notice that the displayed values are now black.

Individual memory locations can be changed by clicking on the value and typing in a new value in hexadecimal. Notice that the changed values will be displayed in red. This means the value has changed but has not been written to the emulated serial EEPROM. Click on the **Write EE** button and the values will be written. The color of the value will turn to black indicating that the value has been written and the display matches the contents of the emulated serial EEPROM.

FIGURE 2-4: 28-PIN DEMO I²C™ – EEPROM

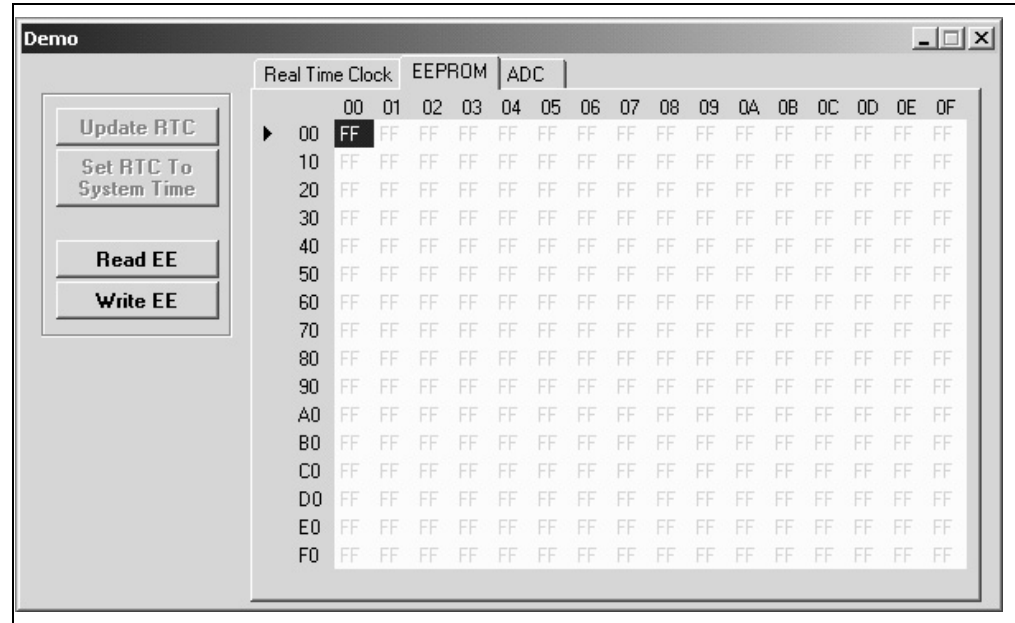

2.7.3 Analog-to-Digital Converter (ADC)

Clicking on the ADC tab will show a meter gauge displaying the value of the ADC as read from potentiometer RP1 as shown in Figure 2-5.

The meter gauge displays the Most Significant 8 bits of the 10-bit ADC internal to the PIC[®] microcontroller. Rotate potentiometer RP1 and the display changes almost instantaneously. The demonstration program will constantly poll the 28-Pin Demo Board and display the contents of the ADC.

FIGURE 2-5: 28-PIN DEMO I²C™ – ADC

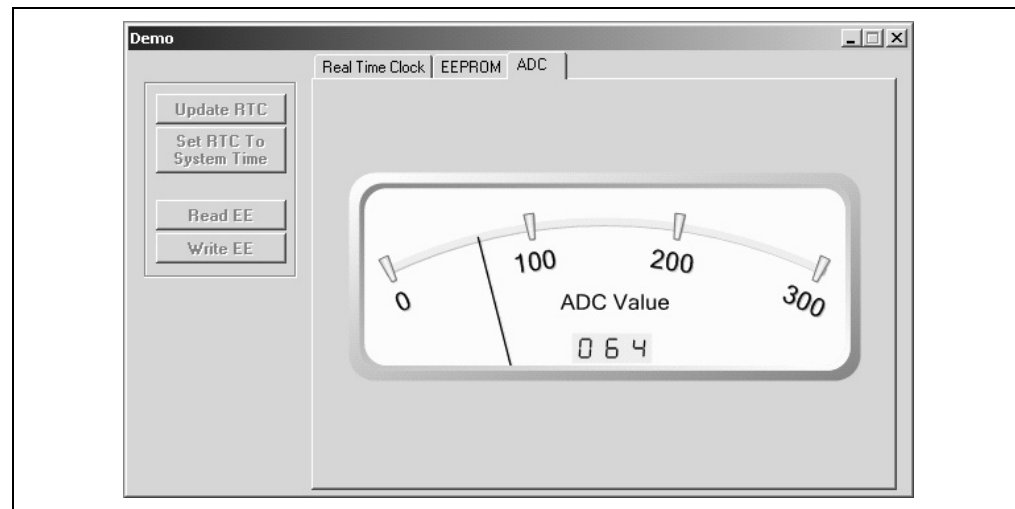

PICkit™ Serial Analyzer User's Guide

2.8 I²C™ COMMUNICATIONS – BASIC OPERATIONS

Individual I²C commands and data can be read and written to the 28-Pin Demo Board from the Basic Operations window as shown in Figure 2-6. Ensure that the PICkit Serial Analyzer program is in I²C Master mode by selecting *PICkit Serial Analyzer > Run Configuration Wizard* from the menu bar and selecting I²C Master.

Note: The 28-Pin Demo I²C window and the Basic Operations window cannot be opened at the same time. When the 28-Pin Demo I²C window is opened, the Basic Operations window will automatically close.

FIGURE 2-6: I²C™ BASIC OPERATIONS

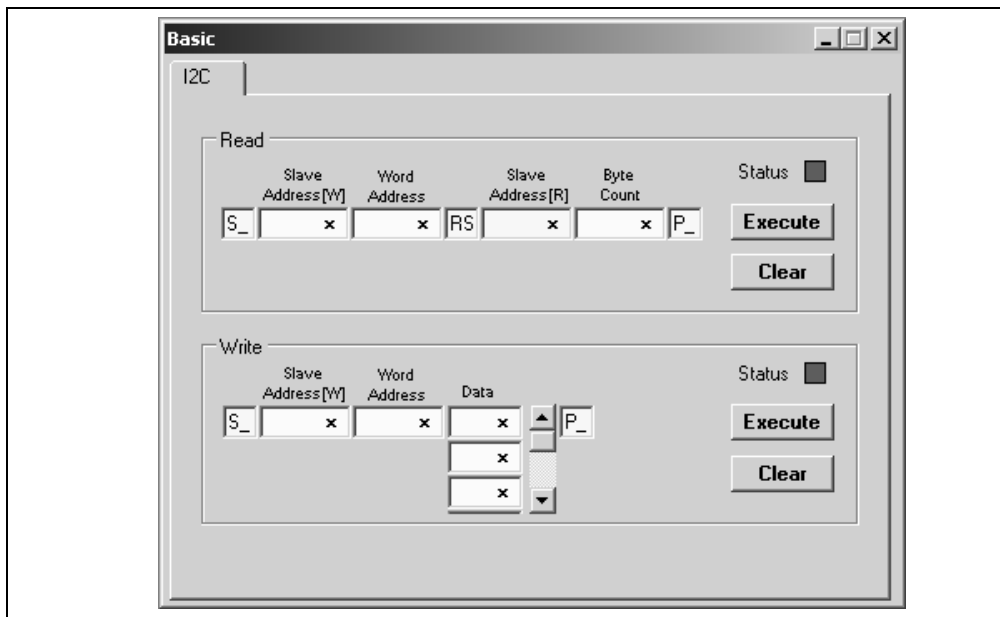

2.8.1 Real-Time Clock (RTC)

The Slave address for the emulated real-time clock on the 28-Pin Demo Board is hexadecimal A2 (0xA2). The Word Address selects the following memory locations:

TABLE 2-1: MEMORY LOCATIONS

Word Address	Contents
0x00	Configuration 1
0x01	Configuration 2
0x02	Seconds
0x03	Minutes
0x04	Hours
0x05	Days
0x06	Weekdays
0x07	Months
0x08	Years

For example, to read seconds from the real-time clock:

Step 1 – Enter 0xA2 into the Slave Address[W] block in the Read section of the Basic Operations window (top half of window)

Step 2 – Enter 0x02 into the Word Address block

Step 3 – Note that the Slave Address[R] has already been entered for you (the Read bit is set).

Step 4 – Enter 0x01 into the Byte Count block

Step 5 – Click on the **Execute** button

The I²C combination command (Write then Read) will be sent to the 28-Pin Demo Board. The command and the contents of Word Address 0x02 (seconds) will be displayed in the transaction window as shown in Figure 2-7.

FIGURE 2-7: RTC TRANSACTIONS DEMO

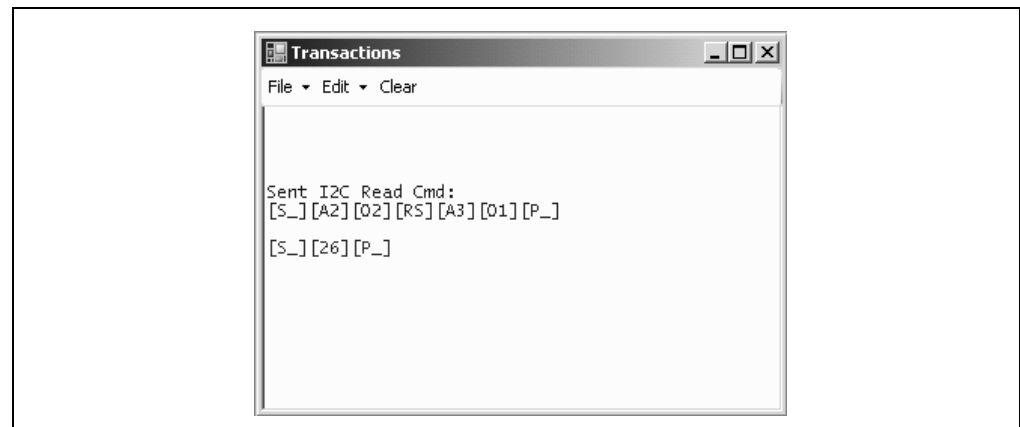

2.8.2 EEPROM

The Slave address for the emulated Serial EEPROM on the 28-Pin Demo Board is hexadecimal A8 (0xA8). The Word Address selects one of 256 8-bit memory locations:

TABLE 2-2: WORD ADDRESS CONTENTS

Word Address	Contents
0x00	Memory Contents
...	...
0xFF	Memory Contents

2.8.3 ADC

The Slave address for the ADC on the 28-Pin Demo Board is hexadecimal AA (0xAA). The Word Address 0x01 selects the memory location containing the Most Significant 8 bits of the 10-bit ADC of the PIC microcontroller.

2.9 28-PIN DEMO I²C™ SOURCE CODE AND FIRMWARE

The demo program source code and *.hex file can be found on the PICkit Serial CD-ROM at *D:\28-pin Demo Board\Firmware*.

PICkit™ Serial Analyzer User's Guide

NOTES:

Chapter 3. PICKit™ Serial Analyzer PC Program

3.1 INTRODUCTION

This chapter covers the installation, starting and high level operations of the PICKit Serial Analyzer program. Detailed information about the entering of data and commands for specific serial communications modes are given in the following chapters.

3.2 HIGHLIGHTS

This chapter discusses:

- Installing The PICKit Serial Analyzer Software
- Starting the Program
- Configuration Wizard
- Main Window
- Specific Communications Modes

3.3 INSTALLING THE PICKit™ SERIAL ANALYZER SOFTWARE

Insert the PICKit Serial Analyzer CD-ROM into the CD-ROM drive. In a few moments the introductory screen should be displayed. Follow the directions on the screen to install the PICKit Serial Analyzer software.

If the introductory screen does not appear, browse to the CD-ROM directory and select the AutorunPro.exe program.

Note: The PICKit Serial Analyzer program requires the Microsoft® .NET Framework Version 2.0.

3.4 STARTING THE PROGRAM

You can start the program by

- Clicking on the desktop icon, or
- Navigating to *Start>All Programs>Microchip>PICKit Serial Analyzer*

After a few moments, the program will start and display the main window as shown in Figure 3-1.

FIGURE 3-1: PICKit™ SERIAL ANALYZER MAIN WINDOW

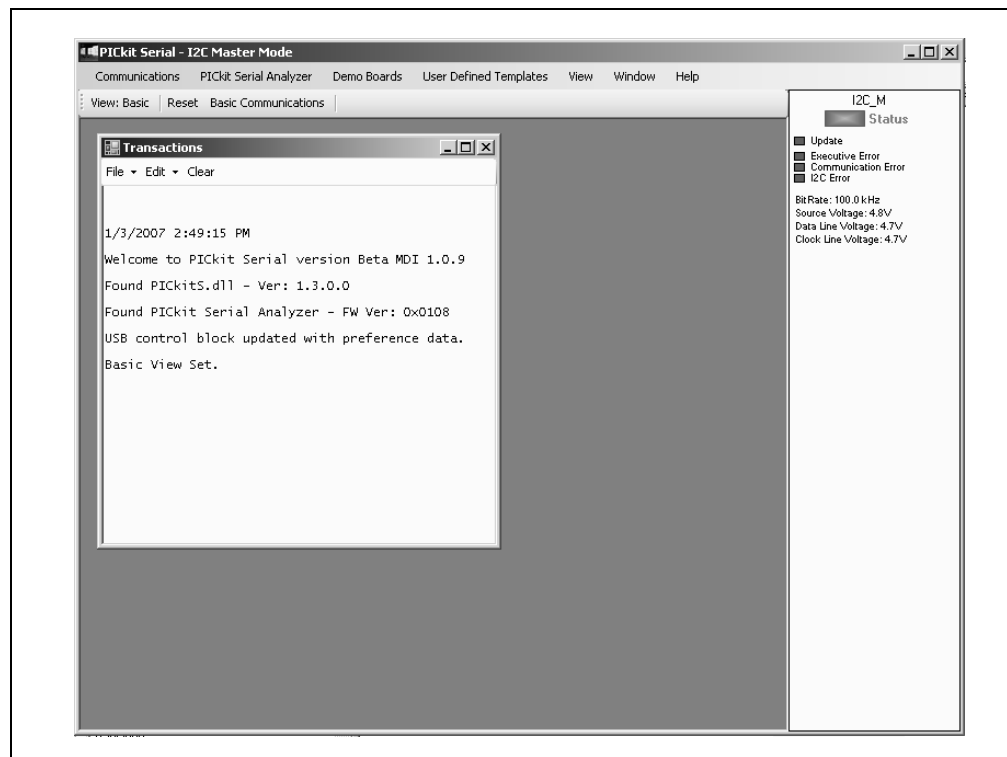

3.5 CONFIGURATION WIZARD

If it is the first time that the PICKit Serial Analyzer program is run, the Configuration Wizard will run automatically. The Configuration Wizard can be manually invoked by selecting *PICKit Serial Analyzer > Run Configuration Wizard* from the menu bar.

The Configuration Wizard will guide you through the basic steps to configure the PICKit Serial Analyzer program for a specific communications mode (I²C, SPI, USART). Advanced configuration can be done from the Configuration Window by selecting *PICKit Serial Analyzer > Configure Communications Mode* from the menu bar.

As an example, Figure 3-2 through Figure 3-7 show how to configure for I²C Master mode. Refer to the specific communications chapter for detailed information on the Configuration Wizard for that communications mode.

The Configuration Wizard Welcome window is shown in Figure 3-2. You may choose to continue by clicking on the **Next** button or canceling the wizard by clicking on the **Cancel** button.

FIGURE 3-2: CONFIGURATION WIZARD – WELCOME

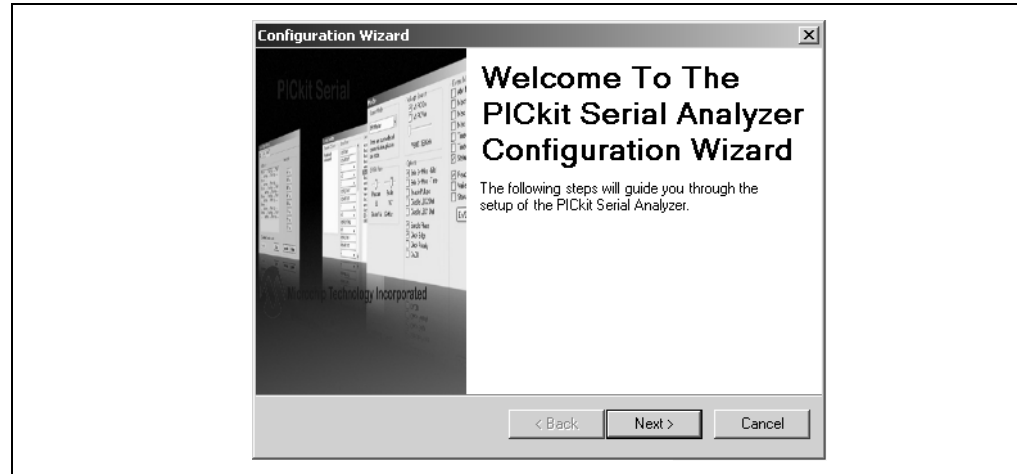

The Configuration Wizard Page 1 of 4, as shown in Figure 3-3, displays the available communications modes and allows you to choose one of the modes.

FIGURE 3-3: CONFIGURATION WIZARD – PAGE 1 OF 4

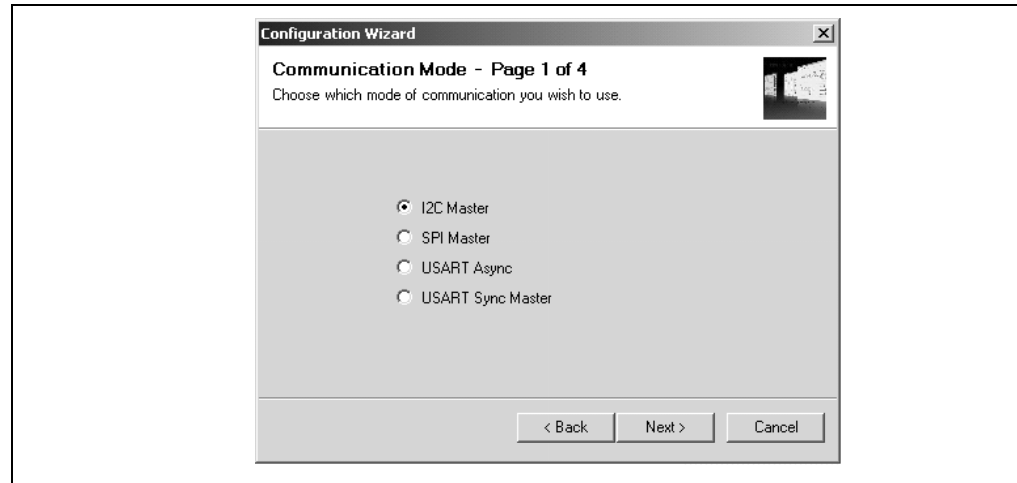

In this example, I²C Master Communication's mode is selected. The Configuration Wizard Page 2 of 4, as shown in Figure 3-4, allows you to select the bus speed. A more comprehensive list of bus speeds can be chosen from the Configuration Window by selecting *PICkit Serial Analyzer > Configure Communications Mode* from the menu bar.

FIGURE 3-4: CONFIGURATION WIZARD – PAGE 2 OF 4

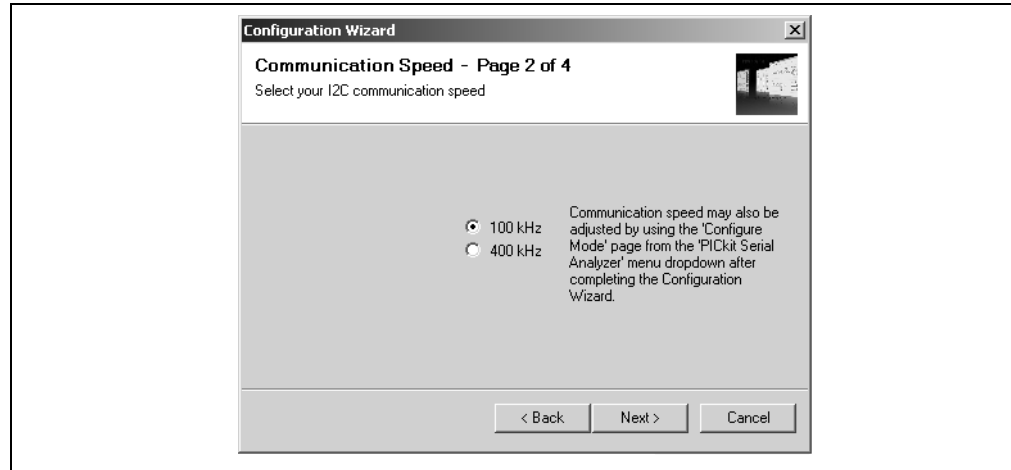

The I²C bus requires pull-up resistors. The PICkit Serial Analyzer has the ability to enable internal 2.2 k Ω pull-up resistors. If the target device does not have pull-up resistors installed, then enable pull-ups by selecting the **Yes** radio button as shown in Figure 3-5. If the target device has the pull-up resistors installed, you can disable the internal pull-ups by selecting the **No** radio button.

FIGURE 3-5: CONFIGURATION WIZARD – PAGE 3 OF 4

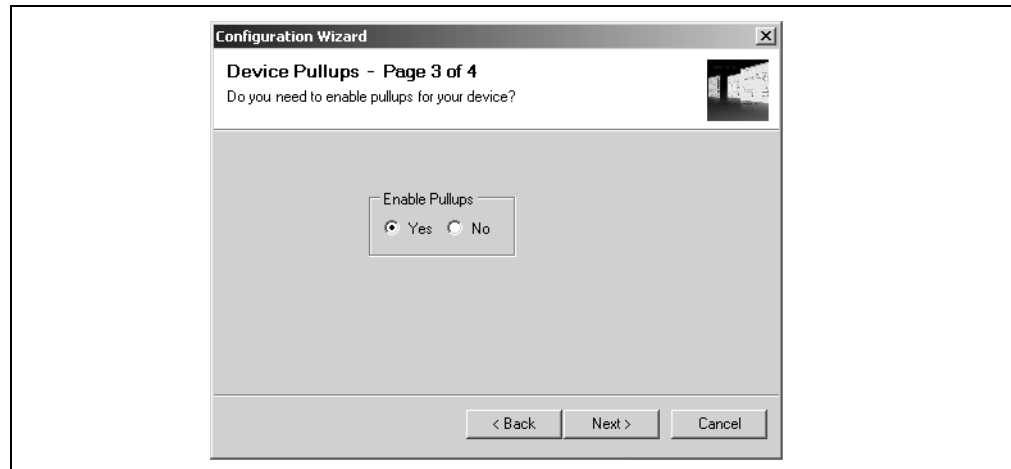

The PICkit Serial Analyzer can power the target device from 0 to 5 VDC at a combined total current limit of 100 mA (PICkit Serial Analyzer plus target device). The Configuration Wizard Page 4 of 4, as shown in Figure 3-6, allows you to choose between powering the target device and selecting the specific target voltage.

CAUTION

Even though the voltage can be set as low as 0 VDC, it is up to the user to verify the required operating voltage of the target device.

CAUTION

The USB port current limit is set to 100 mA. If the target plus PICkit Serial Analyzer exceeds this current limit, the USB port will turn off. The target may be powered externally if more power is required.

FIGURE 3-6: CONFIGURATION WIZARD – PAGE 4 OF 4

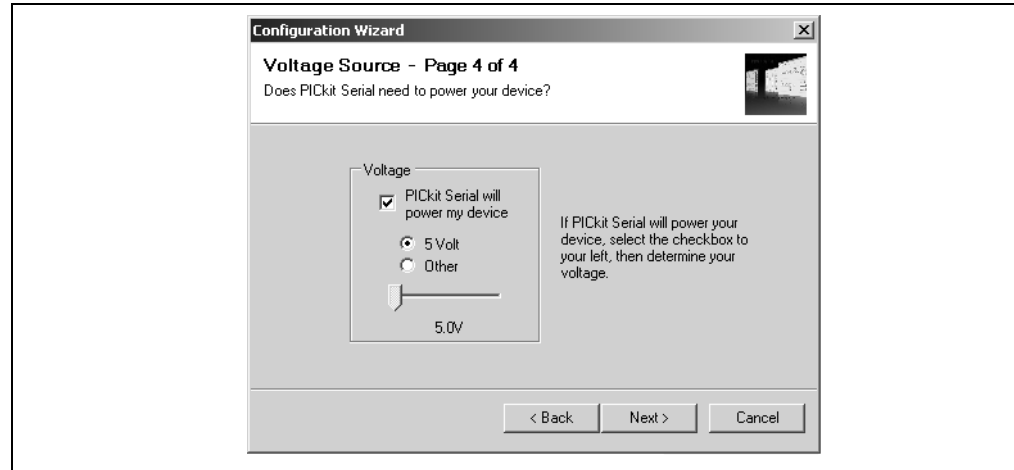

Once all pages of the Configuration Wizard are completed, you can choose to not display the wizard at start up by checking the Do not show this wizard on start-up again check box.

FIGURE 3-7: CONFIGURATION WIZARD – YOU'RE DONE!

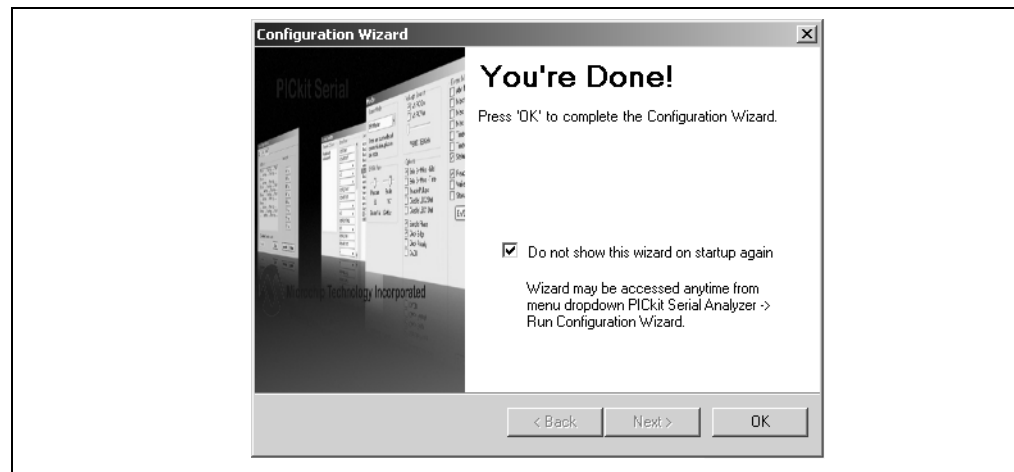

3.6 MAIN WINDOW

3.6.1 Menu Bar

The menu bar selects various functions of the PICkit Serial Analyzer program. A summary of the functions are:

FIGURE 3-8: MENU BAR

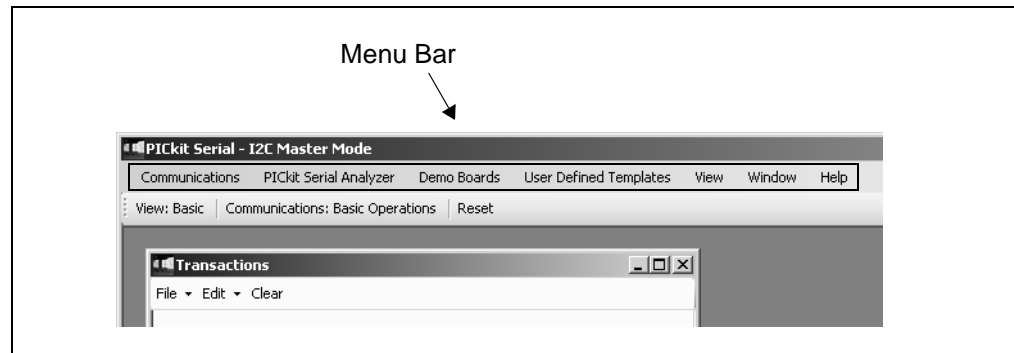

PICkit™ Serial Analyzer User's Guide

COMMUNICATIONS

The Communications menu selections display operation windows to enter data and commands to communicate with the target device.

- Basic Operations – Displays the Basic Operations window for the communications mode selected (see PICkit Serial Analyzer -> Select Communications Mode)
- Script >
 - Script Builder – Displays the Script Builder window
 - Script Execute – Displays the Script Execute window

PICkit™ SERIAL ANALYZER

The PICkit Serial Analyzer menu selection commands the PICkit Serial Analyzer hardware.

- Select Communications Mode >
 - I²C Master – Puts the PICkit Serial Analyzer in I²C Master Communications mode
 - SPI Master – Puts the PICkit Serial Analyzer in SPI Master Communications mode
 - USART Asynchronous – Puts the PICkit Serial Analyzer in USART Asynchronous Communications mode
 - USART Synchronous Master – Puts the PICkit Serial Analyzer in USART Synchronous Master Communications mode
- Configure Communications Mode – Displays the Configuration Communications Mode window for the communications mode selected (see PICkit Serial Analyzer -> Select Communications Mode)
- Download PICkit Serial Analyzer Firmware – Displays the Firmware Download window. Firmware updates are available from the Microchip Technology web site.
- Run Configuration Wizard – Displays the Configuration Wizard
- Perform System Reset – Closes and then reinitializes USB communications to the PICkit Serial Analyzer
- Reset PICkit Serial Analyzer – Resets the PICkit Serial Analyzer if an error condition is present
- PICkit Serial Analyzer No. – Up to four PICkit Serial Analyzers can be controlled from the PC software. The number is assigned to the hardware as it enumerates on the USB bus.

DEMO BOARDS

The Demo Boards menu selection displays the selected demonstration window. The PICkit Serial Analyzer program will be automatically configured for the communications mode of the selected demonstration.

- 28-Pin Demo I²C – Displays the 28-Pin Demo Board I²C demo graphical user interface. For more information see **Appendix B**. “28-Pin Demo Board I²C™ Firmware.”

USER DEFINED TEMPLATES

- Create Template – Displays the Parameter Template creation window
- My Templates – Selects and displays template windows created by the user

VIEW

- Basic – The PICkit Serial Analyzer program will display basic commands and status view

- Advanced – The PICkit Serial Analyzer program will display advanced commands and status view

WINDOW

- New Transaction Window – Opens new or additional transaction window. Multiple transaction windows can be opened as needed for logging communications.
- Close All – Closes all windows
- Cascade – Cascade windows
- Tile Horizontally – Tile windows horizontally
- Tile Vertically – Tile windows vertically

HELP

- About – Displays program version information
- Show PICkit Serial Analyzer Connections – Displays pinout for current communications mode
- Show Event Bytes – Displays Event Marker code for current communication mode

3.6.2 Tool Bar

FIGURE 3-9: TOOL BAR

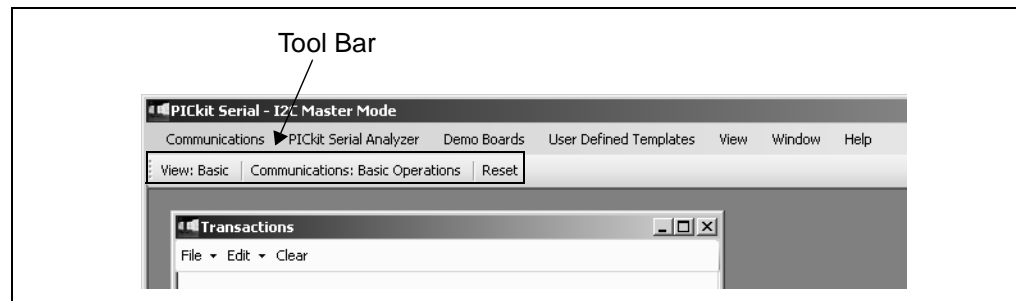

The Tool Bar gives quick access to often used commands. These commands are also available from the Menu Bar.

- View: Basic/Advanced – toggles between Basic and Advanced views
- Reset – Resets the PICkit Serial Analyzer if an error condition is present
- Basic Communications – Displays the Basic Operations window for the communications mode selected

3.6.3 Status Column

The Status Column displays status information for the selected serial communications mode. In Basic View mode, a simplified status is displayed as shown in Figure 3-10. In Advanced View mode additional status information is displayed for the communications mode selected as shown in Figure 3-11.

The status information that is displayed depends on the selected communications mode (I²C, SPI, USART). The following chapters give more detailed explanation of the status window for the particular serial communications mode.

FIGURE 3-10: STATUS COLUMN (BASIC VIEW)

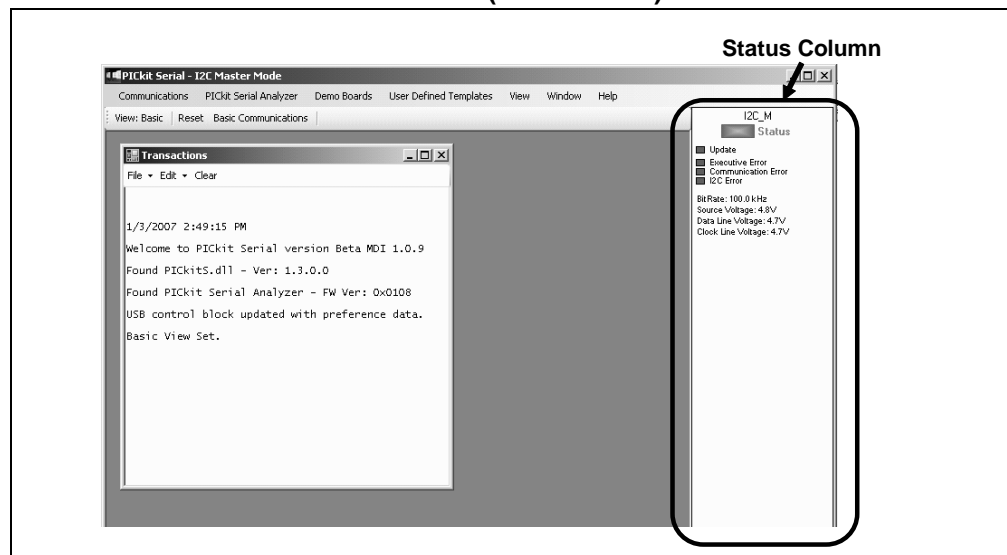
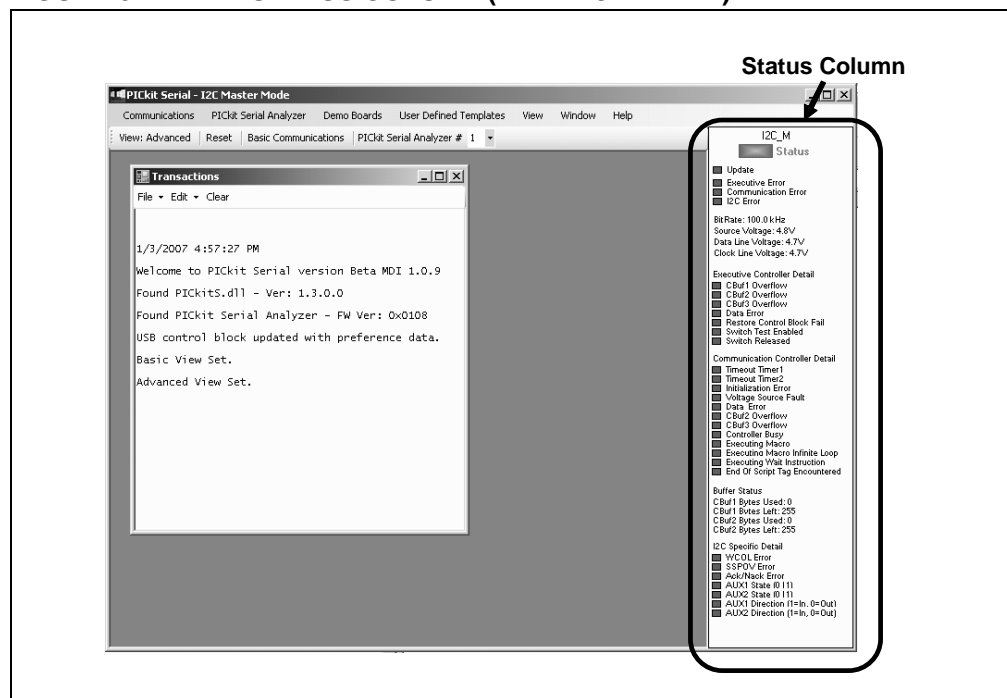

FIGURE 3-11: STATUS COLUMN (ADVANCED VIEW)



3.6.4 Transactions Window

The Transactions window, shown in Figure 3-12, keeps a running log of the commands and data that are communicated between the PICkit Serial Analyzer program and target device.

From the menu bar on the Transaction window, the contents can be saved (*File>Save*) to a *.txt or *.rtf file. The file can later be retrieved (*File>Open*) and displayed in the Transactions window.

Additional Transactions windows can be displayed. From the PICkit Serial Analyzer menu bar, select *Window > New Transaction Window*. The active Transactions window will log the current commands and data.

FIGURE 3-12: TRANSACTIONS WINDOW

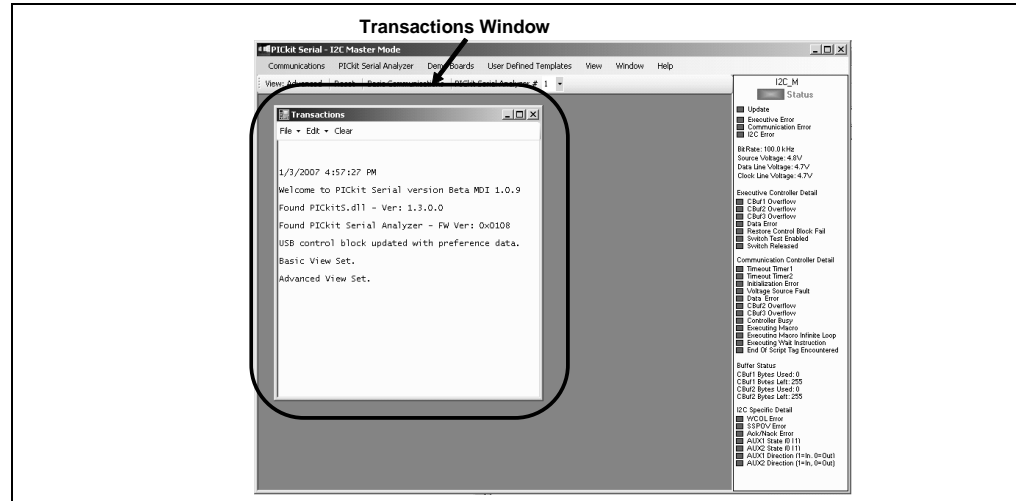

FILE

- **Open** – Opens a *.txt or *.rtf file and displays it in the Transactions window
- **Save** – Saves the contents of the Transactions window to a *.txt or *.rtf file
- **Close** – Closes the selected Transactions window

EDIT

- **Copy** – The selected contents of the Transactions window will be copied to the clipboard
- **Paste** – The contents of the clipboard will be pasted into the Transactions window
- **Select All** – contents of the Transactions window will be selected
- **Clear All** – The contents of the Transactions window will be cleared

The Transaction window also allows usage of the common keyboard shortcuts Ctrl-X, Ctrl-C, Ctrl-V to cut, copy and paste from the clipboard.

CLEAR – The contents of the Transactions window will be cleared

3.7 SERIAL COMMUNICATIONS MODES

Detailed information about the entering of data and commands for specific serial communications modes are given in the following chapters.

PICkit™ Serial Analyzer User's Guide

NOTES:

Chapter 4. I²C™ Master Communications

4.1 INTRODUCTION

This chapter describes the I²C Master Communications mode. I²C data and commands can be entered using a Basic Communications window or by creating Script Commands.

It is assumed that the user is familiar with the I²C protocol. For more information see:

- The I²C-Bus Specification Version 2.1 January 2000 is available from NXP Semiconductor (formerly Philips Semiconductor) web site at http://www.nxp.com/acrobat_download/literature/9398/39340011.pdf
- An I²C Master Communications tutorial is available on the Microchip Technology web site. Click on the links: Support -> Getting Started -> PIC MCU Tutorials -> I2C Master Mode
- Several application notes are available on the Microchip Technology web site. Click on links: Design -> App Notes -> Function: Communications -> I2C

4.2 HIGHLIGHTS

This chapter discusses:

- PICkit Serial Pin Assignments
- Selecting Communications Mode
- Configuring I²C Communications Mode
- Communications: Basic Operations
- Script Builder
- Script Execute

4.3 PICKIT SERIAL PIN ASSIGNMENTS

The PICkit Serial Analyzer pin assignments for I²C Master mode are:

TABLE 4-1: PIN ASSIGNMENTS

Pin	Label	Type	Description
1	AUX1	Input/Output	Auxiliary I/O port pin No. 1
2	+V	Power	Target Power
3	GND	Power	Ground
4	SDA	Input/Output	Serial Data
5	SCL	Power	Serial Clock
6	AUX2	Input/Output	Auxiliary I/O port pin No. 2

4.4 SELECTING COMMUNICATIONS MODE

The I²C Master Communications mode is selected from the Configuration Wizard or menu bar.

Configuration Wizard – Select *PICKit Serial Analyzer > Run Configuration Wizard* from the menu bar

PICkit™ Serial Analyzer User's Guide

Menu Bar – Select *PICkit Serial Analyzer > Select Communications Mode > I²C Master*

4.5 CONFIGURING I²C COMMUNICATIONS MODE

Once the communications mode has been selected, it is configured from the Configuration Wizard or menu bar.

Configuration Wizard – Select *PICkit Serial Analyzer > Run Configuration Wizard* from the menu bar

Menu Bar – Select *PICkit Serial Analyzer > Configure Communications Mode*

The Configure Mode window will open. Depending on the View selected, the Basic View (Figures 4-1) displays a minimum choice of configurations commands. In the Advanced View (Figures 4-2) displays an extended choice of configuration commands. Save the configuration by clicking on the **Save Changes** button.

FIGURE 4-1: I²C™ CONFIGURE COMMUNICATIONS MODE – BASIC VIEW

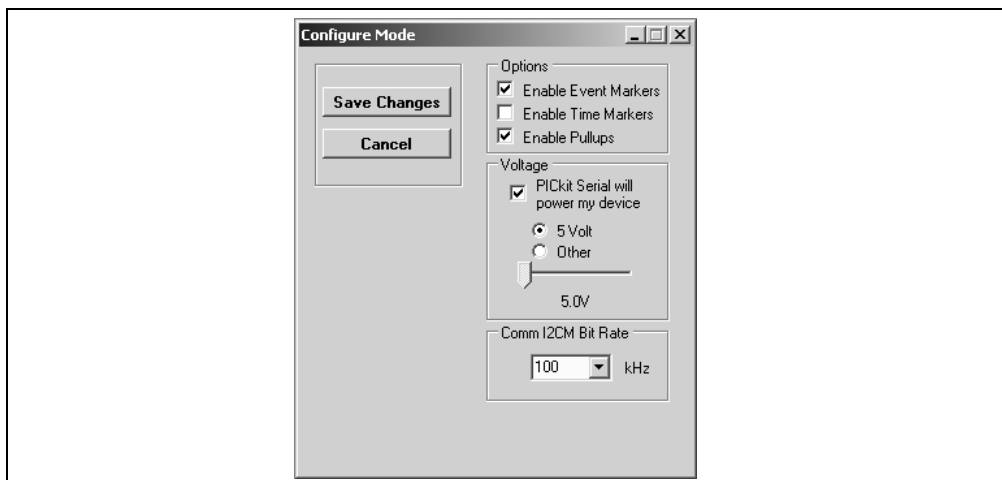

OPTIONS

- Enable Event Markers – Enable event markers
- Enable Time Markers – Enable 'time' stamp to accompany all event markers
- Enable Pull-ups – Enable internal 2.2 k Ω pull-ups on SDA and SCL communication lines

VOLTAGE

- PICkit Serial will power my device – Select the check box if the PICkit Serial will power the target device. The target can be powered at 5 VDC or a user selectable variable voltage.

CAUTION

Even though the voltage can be set as low as 0 VDC, it is up to the user to verify the required operating voltage of the target device.

CAUTION

The USB port current limit is set to 100 mA. If the target plus PICkit Serial Analyzer exceeds this current limit, the USB port will turn off. The target may be powered externally if more power is required.

COMM I²C BIT RATE

Select the desired I²C bus bit rate using the drop down box.

FIGURE 4-2: I²C™ CONFIGURE COMMUNICATIONS MODE – ADVANCED VIEW

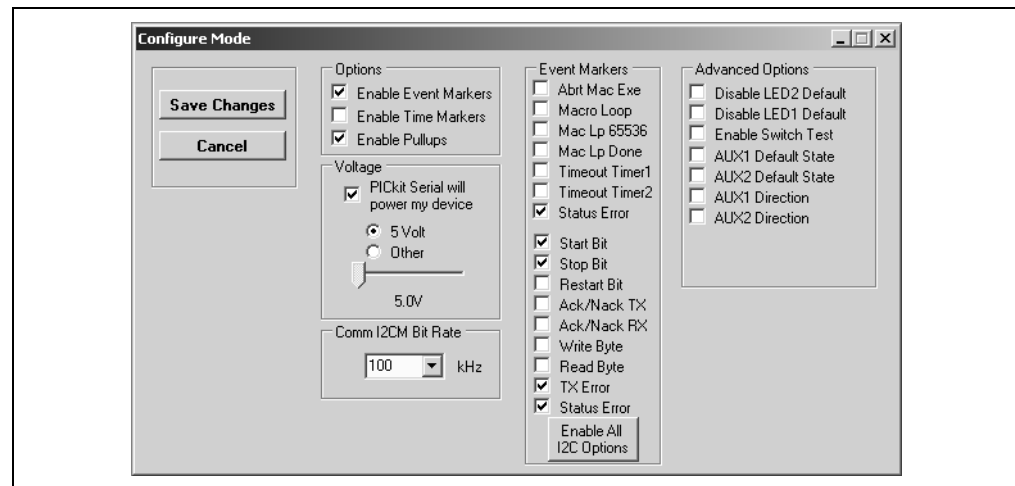

EVENT MARKERS

- Abrt Mac Exe – Enable event marker: abort ‘macro’ execution
- Macro Loop – Enable event marker: top of ‘macro’ loop
- Mac Lp 65536 – Enable event marker: ‘macro’ loop count overflow (i.e., 65536)
- Mac Lp Done – Enable event marker: ‘macro’ loop iterations complete
- Timeout Timer1 – Enable event marker: Timer1 expired
- Timeout Timer2 – Enable event marker: Timer2 expired
- Status Error – Enable event marker: change in status byte

- Start Bit – Enable event marker – Start bit
- Stop Bit – Enable event marker – Stop bit
- Restart Bit – Enable event marker – Restart bit
- Ack/Nack TX – Enable event marker – Ack or Nack byte transmit
- Ack/Nack RX – Enable event marker – Ack or Nack byte received
- Write Byte – Enable event marker – write byte
- Read Byte – Enable event marker – read byte
- TX Error – Enable event marker – TX error
- Status Error – Enable event marker – change in I²C status byte

ADVANCED OPTIONS

- Disable LED2 Default – Disable default LED2 behavior (LED2 = Yellow ‘Target’ LED)
- Disable LED1 Default – Disable default LED1 behavior (LED1 = Red ‘Busy’ LED)
- Enable Switch Test – Enable low level switch test:
 - Switch Off (not depressed) – blink LED1, LED2 off
 - Switch ON (depressed) – blink LED2, LED1 off
- AUX1 Default State – AUX1 communication line – default state (0 | 1)
- AUX2 Default State – AUX2 communication line – default state (0 | 1)
- AUX1 Direction – AUX1 communication line – direction: 1: input, 0: output

- AUX2 Direction – AUX2 communication line – direction: 1: input, 0: output

4.6 COMMUNICATIONS: BASIC OPERATIONS

The I²C Basic Operations window can be opened by selecting:

- Communications: Basic Operations from the tool bar, or
- Communications > Basic Operations from the menu bar

The I²C Basic Operations window is shown in Figures 4-3. There are two basic communications commands, Read and Write.

Read performs a combination Write then Read commands to the target device (refer to the I²C Specification reference in **Section 4.1 “Introduction”** above). The basic structure of the command is:

- Start bit (S_)
- Slave Address[W] – Enter the slave address of the device to communicate with. The write bit should be cleared to indicate a write operation
- Word Address – Enter the word address
- Restart (RS),
- Slave Address[R] – The slave address with the write bit set will be automatically entered when the Slave Address[W] has been entered
- Byte Count – Enter the number of bytes to be read
- Stop bit (P_)

Note: The “x” indicates the value is a hexadecimal number. Clicking on “x” will toggle it to a “d” indicating that the value is a decimal number.

Write performs a write operation to the target device (refer to The I²C Specification reference in **Section 4.1 “Introduction”** above). The basic structure of the command is:

- Start bit (S_)
- Slave Address[W] – Enter the slave address of the device to communicate with. The write bit should be cleared to indicate a write operation.
- Word Address – Enter the word address
- Data – Enter up to eight bytes of data
- Stop bit (P_)

The command will be logged in the Transactions window. A listing of the command abbreviations is given in Table 4-2.

FIGURE 4-3: I²C™ BASIC OPERATIONS

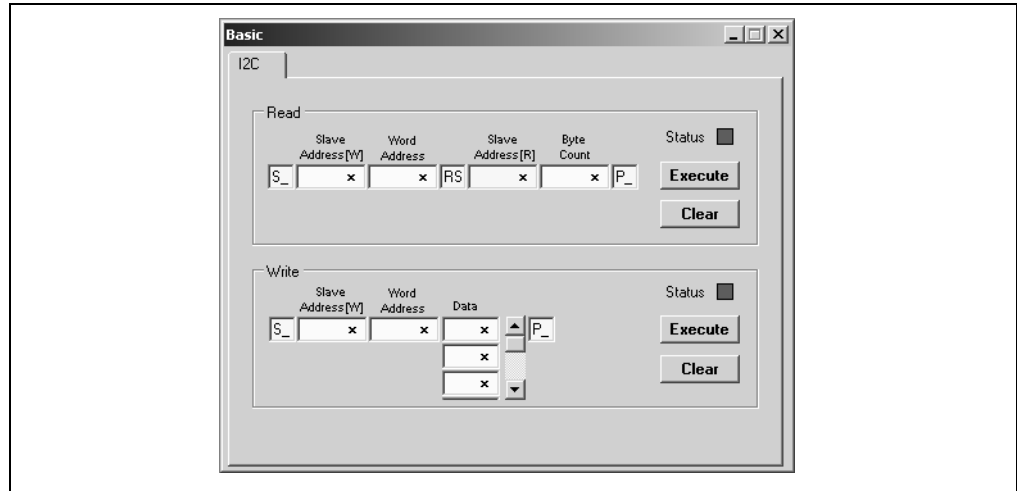

4.7 SCRIPT BUILDER

I²C commands can be combined into scripts, saved, and used over again. The Script Builder window is opened by selecting *Communications > Script > Script Builder* from the menu bar. The Script Builder is shown in Figures 4-4.

The Script Builder window is divided into four columns as shown in Figures 4-5 through 4-8.

FIGURE 4-4: I²C™ SCRIPT BUILDER

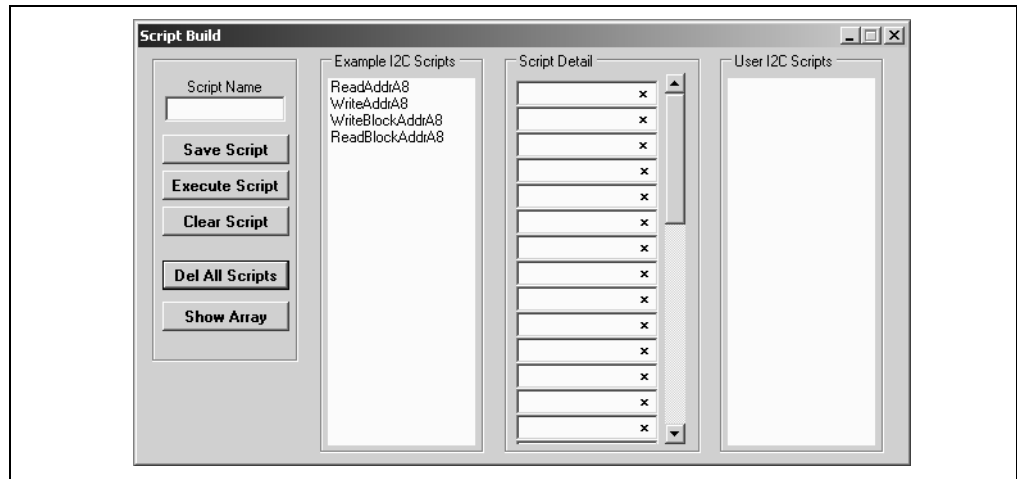

4.7.1 Script Commands

The left most column contains the Script Commands as shown in Figures 4-5.

- **Script Name** – Enter the name of the script
- **Save Script** – Saves the script
- **Execute Script** – Executes (performs) the script displayed in the Script Detail column
- **Clear Script** – Clears the Script Detail column
- **Del User Scripts** – Deletes scripts from the User Scripts column.
- **Show Array** – Displays a spreadsheet-like table in which large amounts of data may be entered. This data can be included in the script by right clicking in a Script Detail cell and choosing “Insert Array”.

FIGURE 4-5: I²C™ SCRIPT BUILDER – SCRIPT COMMANDS

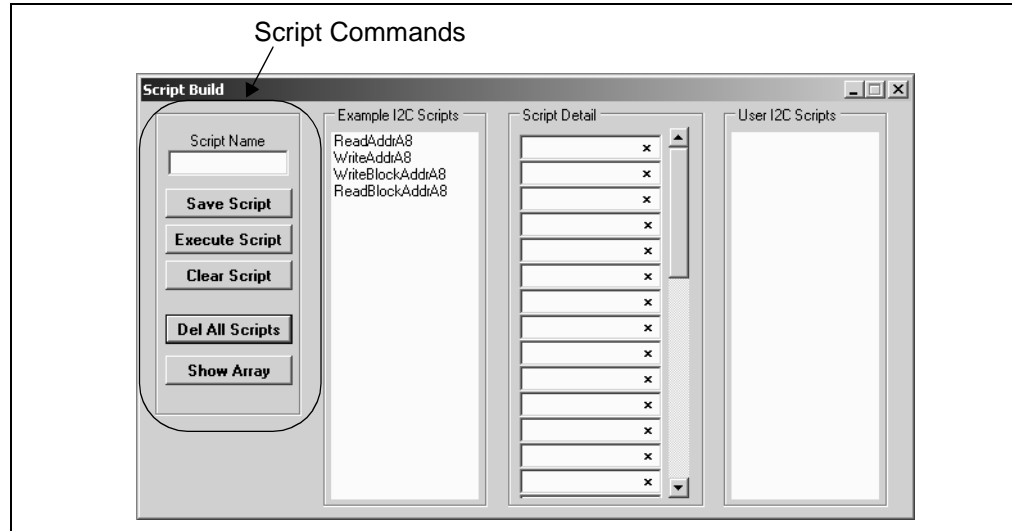

4.7.2 Example Scripts

The second column contains Example Scripts as shown in Figures 4-6. These can be studied to learn how to create or to edit custom scripts. To load the example script into the Script Detail column, either double click or right click and select from the local menu.

FIGURE 4-6: I²C™ SCRIPT BUILDER – EXAMPLE SCRIPTS

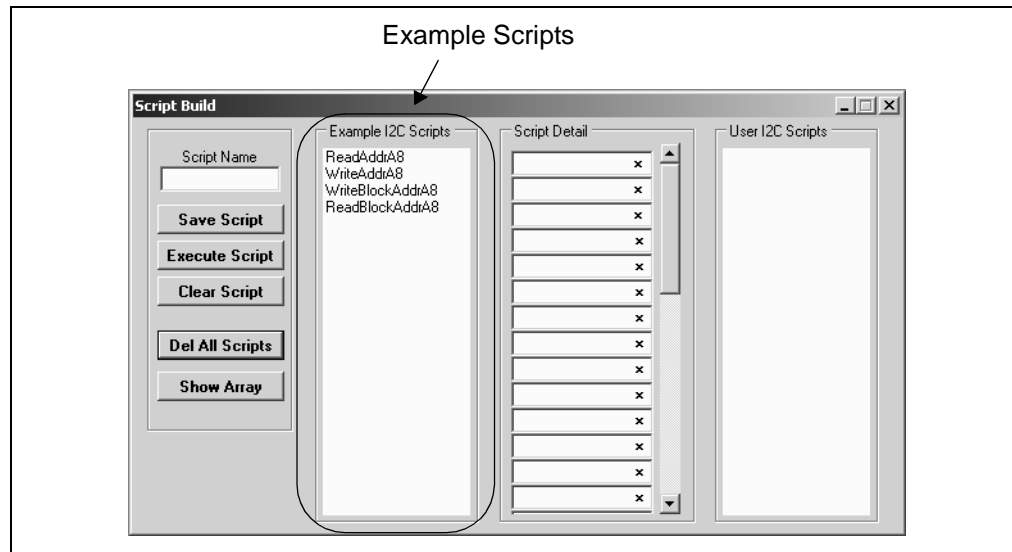

4.7.3 Script Detail

The third column contains Script Detail as shown in Figures 4-7. This column is used to create the script or view an existing script. More information about creating a custom script is discussed in **Section 4.7.5 “Creating A Script”**.

To load a user script from the User Scripts column into the Script Detail column, the user can double click or right click and select from the local menu.

Note: The “x” indicates the value is a hexadecimal number. Clicking on “x” will toggle it to a “d” indicating that the value is a decimal number.

FIGURE 4-7: I²C™ SCRIPT BUILDER – SCRIPT DETAIL

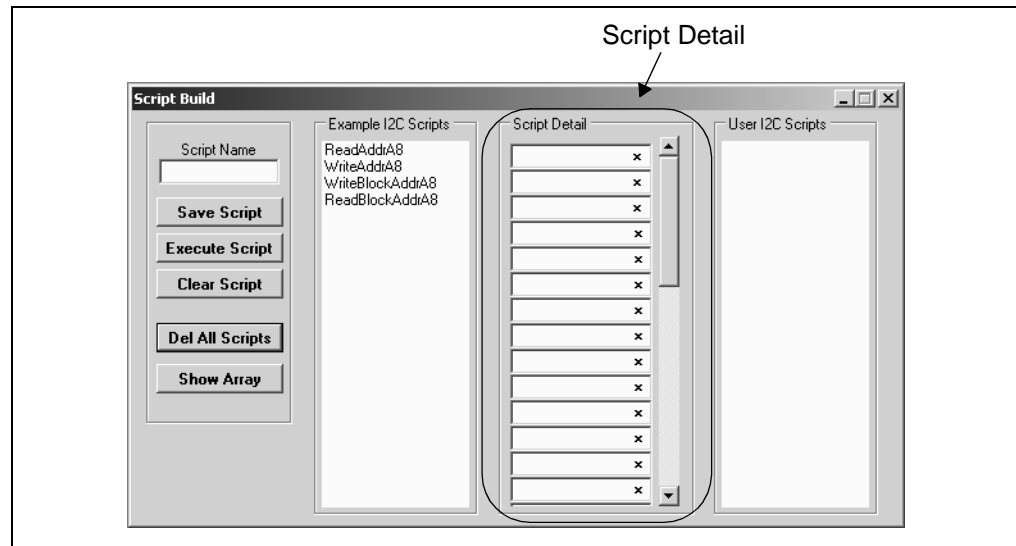

4.7.4 User Scripts

The fourth column contains User Scripts as shown in Figures 4-8. User scripts that are created, named, and saved are displayed in the User Scripts column.

To load a user script from the User Scripts column into the Script Detail column, the user can double click or right click and select from the local menu.

User Scripts can be deleted by right clicking and selecting Delete Script from the local menu.

FIGURE 4-8: I²C™ SCRIPT BUILDER – USER SCRIPTS

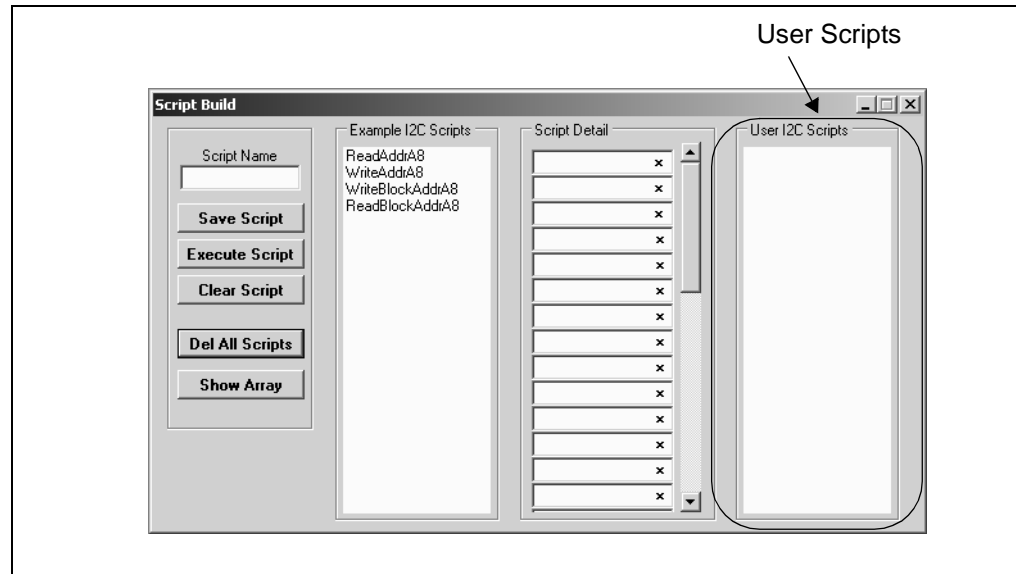

4.7.5 Creating A Script

Scripts are created by placing the cursor into the Script Detail column and right clicking. A local menu will be displayed as shown in Figures 4-9. Select from the choice of commands or script macro commands.

The sequence of macro commands are executed from top to bottom. Macro commands are entered by right clicking in the box and selecting from the local menu as shown in Figures 4-9.

PICkit™ Serial Analyzer User's Guide

Macro commands are entered according to the sequence of events as defined by the I²C bus protocol. Studying the example scripts is a good way to learn the sequence of events. The example scripts can also be modified and saved under a different name.

CAUTION

The choice of macro commands is very flexible. Therefore, the correctness of the script has to be verified by the user. The PICkit Serial Analyzer program does not verify the correctness of the script.

A complete listing of the available macro commands is given in Table 4-2. The macro command abbreviation will be displayed in the Transactions Window. The Transactions window keeps a running log of the commands and data sent to and from the target device.

FIGURE 4-9: I²C™ SCRIPT BUILDER – CREATING A SCRIPT

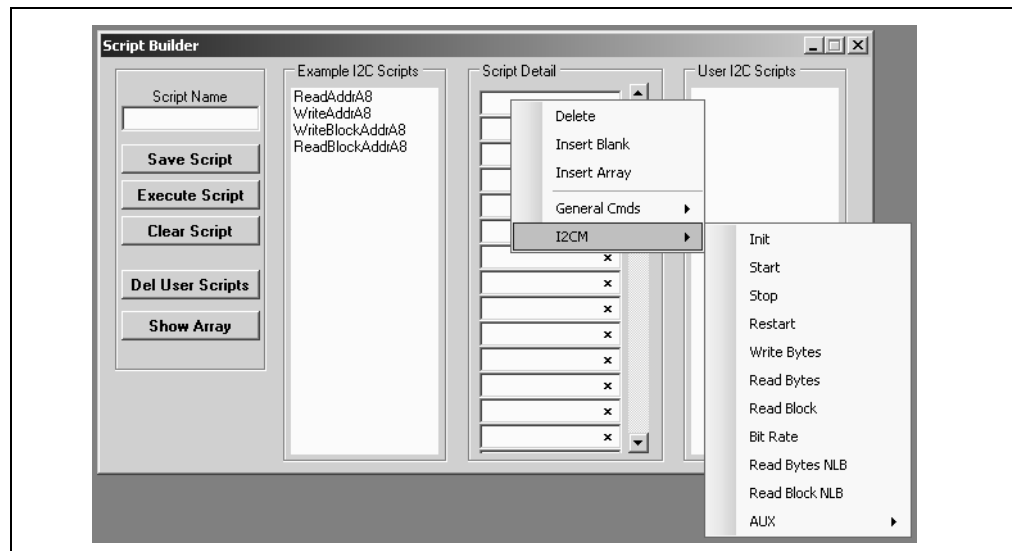

TABLE 4-2: I²C™ SCRIPT MACRO COMMAND

Macro Command	Command Abbreviation	Description
I2CINIT	[I_]	I ² C™ Initialization
I2CSTART	[S_]	I ² C™ Start
I2CSTOP	[P_]	I ² C™ Stop
I2CRESTART	[RS]	I ² C™ Restart
I2CWRTBYT	[W_]	I ² C™ Write Bytes. Next byte is the byte count, followed by the data.
I2CRDBYT	[R_]	I ² C™ Read Bytes. Next byte is the byte count.
I2CRDBLK	[RB]	I ² C™ Read Block
I2CBITRATE	[BR]	Set I ² C™ Bit Rate - min:0 = 35k, max:127 = 100k. Next byte is the bit rate.
I2CRESET	[RE]	Reset MSSP module
I2CRDBYTNLB	[RN]	Read bytes - NACK last byte. Next byte is the byte count
I2CRDBLKNLB	[RBN]	Read block - NACK last byte
I2CAUX1RST	[A1RST]	Reset AUX1

TABLE 4-2: I²C™ SCRIPT MACRO COMMAND (CONTINUED)

I2CAUX1SET	[A1RST]	Set AUX1
I2CAUX1OUT	[A1OUT]	Set AUX1 direction to Output
I2CAUX1IN	[A1IN]	Set AUX1 direction to Input
I2CAUX1W0	[A1W0]	AUX1 Wait 0
I2CAUX1W1	[A1W1]	AUX1 Wait 1
I2CAUX2RST	[A2RST]	Reset AUX2
I2CAUX2SET	[A2RST]	Set AUX2
I2CAUX2OUT	[A2OUT]	Set AUX2 direction to Output
I2CAUX2IN	[A2IN]	Set AUX2 direction to Input
I2CAUX2W0	[A2W0]	AUX2 Wait 0
I2CAUX2W1	[A2W1]	AUX2 Wait 1

4.8 SCRIPT EXECUTE

The Script Execute window is shown in Figures 4-10. Once scripts are created using the Script Builder, they can be assigned to buttons in the Script Execute window. This makes a convenient window to execute multiple scripts either individually or iteratively. Script executing will be logged in the Transactions window. The Script Execute window is opened by selecting *Communications > Script > Script Execute* from the menu bar.

FIGURE 4-10: I²C™ SCRIPT EXECUTE

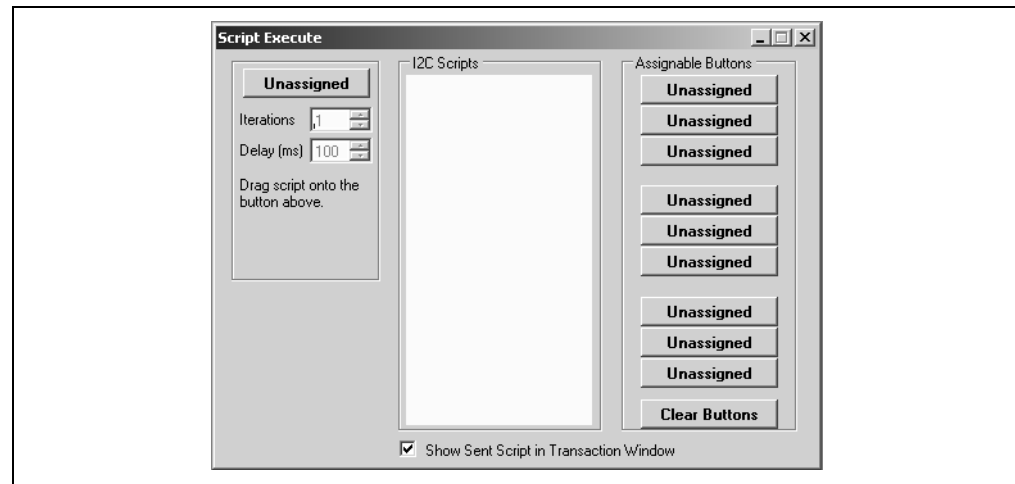

4.8.1 Assignable Buttons

User created scripts will be displayed in the central I²C Scripts column. To assign a script to a button, click on the script name and drag it to the desired Assignable Buttons in the right column. The script will be executed once each time the button is clicked. The Assignable Buttons can be cleared by clicking on the **Clear Buttons** button.

4.8.2 Iteration

Scripts can be executed a user defined number of times at a specified interval of time. Figure 4-11 shows an example. A script named Read_Memory has been assigned to the **Iteration** button in the left column. The number of iterations are entered in the Iterations box and the delay in millisecond in the Delay box. A summary of the iterations is displayed in the left column. The macro is executed when the **Iteration** button is clicked.

FIGURE 4-11: I²C™ SCRIPT EXECUTE – EXAMPLE

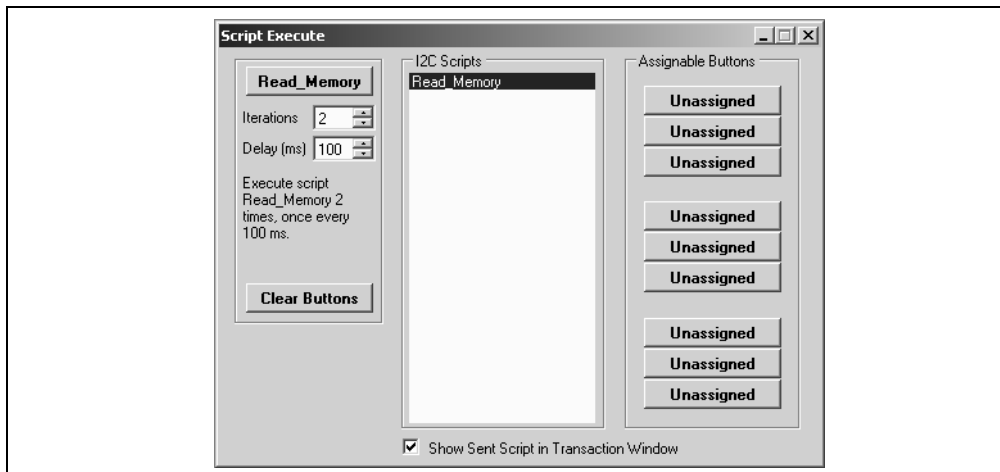

Chapter 5. SPI Master Communications

5.1 INTRODUCTION

This chapter describes the SPI Master Communications mode. SPI data and commands can be entered using a Basic Communications window or by creating Script Commands.

It is assumed that the user is familiar with the SPI protocol. For more information see: An SPI tutorial is available on the Microchip Technology web site. Click on the links: Support -> Getting Started -> PIC MCU Tutorials -> SPI - PICmicro Serial Peripheral Interface

Several application notes are available on the Microchip Technology web site. Click on links: Design -> App Notes -> Function: Communications -> SPI

5.2 HIGHLIGHTS

This chapter discusses:

- PICKit Serial Analyzer Pin Assignments
- Selecting Communications Mode
- Configuring SPI Communications Mode
- Communications: Basic Operations
- Script Builder
- Script Execute

5.3 PICKit™ SERIAL ANALYZER PIN ASSIGNMENTS

The PICKit Serial Analyzer pin assignments for SPI Master mode are:

TABLE 5-1: PIN ASSIGNMENTS

Pin	Label	Type	Description
1	\overline{CS}	Output	Chip Select (Active Low)
2	+V	Power	Target Power
3	GND	Power	Ground
4	SDI	Input	Serial Data In (with respect to the PICKit Serial Analyzer)
5	SCK	Output	Serial Clock
6	SDO	Output	Serial Data Out (with respect to the PICKit Serial Analyzer)

5.4 SELECTING COMMUNICATIONS MODE

The SPI Master Communications mode is selected from the Configuration Wizard or menu bar.

Configuration Wizard – Select *PICKit Serial Analyzer > Run Configuration Wizard* from the menu bar

PICkit™ Serial Analyzer User's Guide

Menu Bar – Select *PICkit Serial Analyzer > Select Communications Mode > SPI Master*

5.5 CONFIGURATING SPI COMMUNICATIONS MODE

Once the communications mode has been selected, it is configured from the Configuration Wizard or menu bar.

Configuration Wizard – Select *PICkit Serial Analyzer > Run Configuration Wizard* from the menu bar

Menu Bar – Select *PICkit Serial Analyzer > Configure Communications Mode*

The Configure Mode window will open. Depending on the View selected, the Basic View (Figure 5-1) displays a minimum choice of configurations commands. In the Advanced View (Figure 5-2) displays an extended choice of configuration commands. Save the configuration by clicking on the **Save Changes** button.

FIGURE 5-1: SPI CONFIGURE COMMUNICATIONS MODE – BASIC VIEW

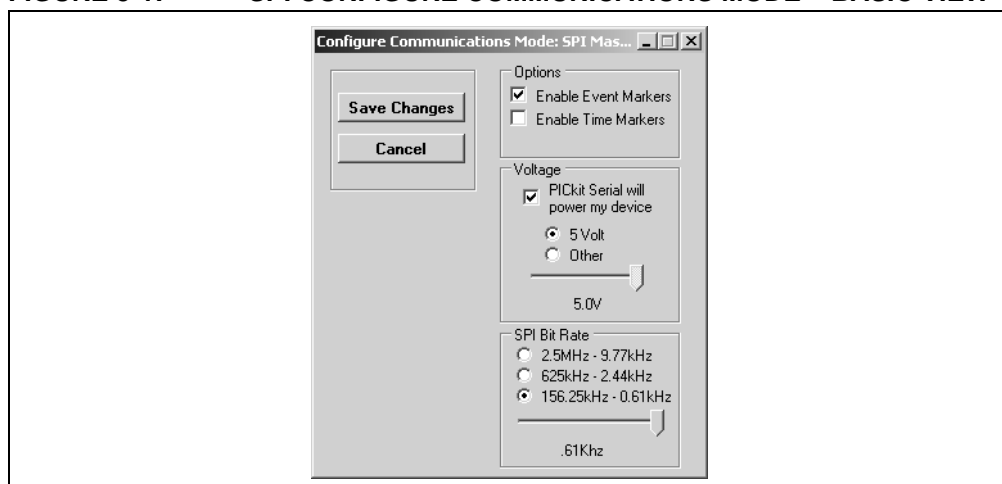

OPTIONS

- Enable Event Markers – Enable event markers
- Enable Time Markers – Enable ‘time’ stamp to accompany all event markers

VOLTAGE

- PICkit Serial will power my device – Select the check box if the PICkit Serial will power the target device. The target can be powered at 5 VDC or a user selectable variable voltage.

CAUTION

Even though the voltage can be set as low as 0 VDC, it is up to the user to verify the required operating voltage of the target device.

CAUTION

The USB port current limit is set to 100 mA. If the target plus PICkit Serial Analyzer exceeds this current limit, the USB port will turn off. The target may be powered externally if more power is required.

SPI BIT RATE

Select the desired SPI bit rate by selecting the radio button for the desired range and then selecting the bit rate using the slider.

FIGURE 5-2: SPI CONFIGURE COMMUNICATIONS MODE – ADVANCED VIEW

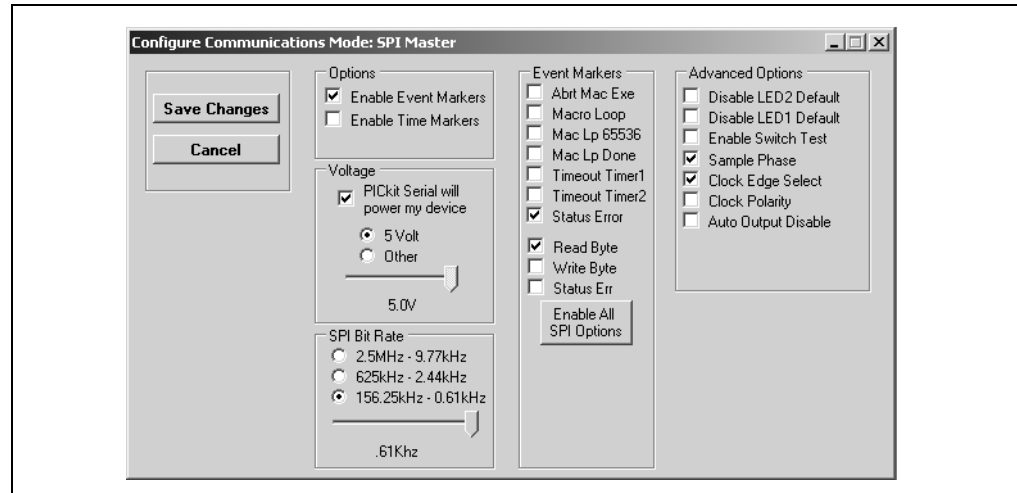

EVENT MARKERS

- Abt Mac Exe – Enable event marker: abort ‘macro’ execution
- Macro Loop – Enable event marker: top of ‘macro’ loop
- Mac Lp 65536 – Enable event marker: ‘macro’ loop count overflow (i.e., 65536)
- Mac Lp Done – Enable event marker: ‘macro’ loop iterations complete
- Timeout Timer1 – Enable event marker: Timer1 expired
- Timeout Timer2 – Enable event marker: Timer2 expired
- Status Error – Enable event marker: change in status byte
- Write Byte – Enable event marker – write byte
- Read Byte – Enable event marker – read byte
- Status Err – Enable event marker – change in SPI status byte

ADVANCED OPTIONS

- Disable LED2 Default – Disable default LED2 behavior (LED2 = Yellow ‘Target’ LED)
- Disable LED1 Default – Disable default LED1 behavior (LED1 = Red ‘Busy’ LED)
- Enable Switch Test – Enable low level switch test:
 - Switch Off (not depressed) – blink LED1, LED2 off
 - Switch ON (depressed) – blink LED2, LED1 off
- Sample Phase – SPI transaction configuration: Sample phase
- Clock Edge Select – SPI transaction configuration: Clock Edge
- Clock Polarity – SPI transaction configuration: Clock Polarity
- Auto Output Disable – Disables output during input. Allows the SDI lines and the SDO lines to be shorted for 3-wire communication.

5.6 COMMUNICATIONS: BASIC OPERATIONS

The SPI Basic Operations window can be opened by selecting:

- *Communications: Basic Operations* from the tool bar, or
- *Communications > Basic Operations* from the menu bar

The SPI Basic Operations window is shown in Figure 5-3. The Basic Operations window is organized into five columns. Individual columns are enabled by clicking on the Enable check box.

The **Send** button indicates that the column boxes are used to enter data bytes that will be transmitted to the target device. Clicking on the **Send** button toggles the column mode to Rcv (Receive) and the number of received bytes is entered as shown in Figure 5-4.

Clicking on the **Execute** button will execute the enabled columns in order from left to right.

The **Clear** button clears all boxes.

Note: The “x” indicates the value is a hexadecimal number. Clicking on “x” will toggle it to a “d” indicating that the value is a decimal number.

The commands will be logged in the Transactions window. A listing of the command abbreviations is given in Table 5-2.

FIGURE 5-3: SPI BASIC OPERATIONS

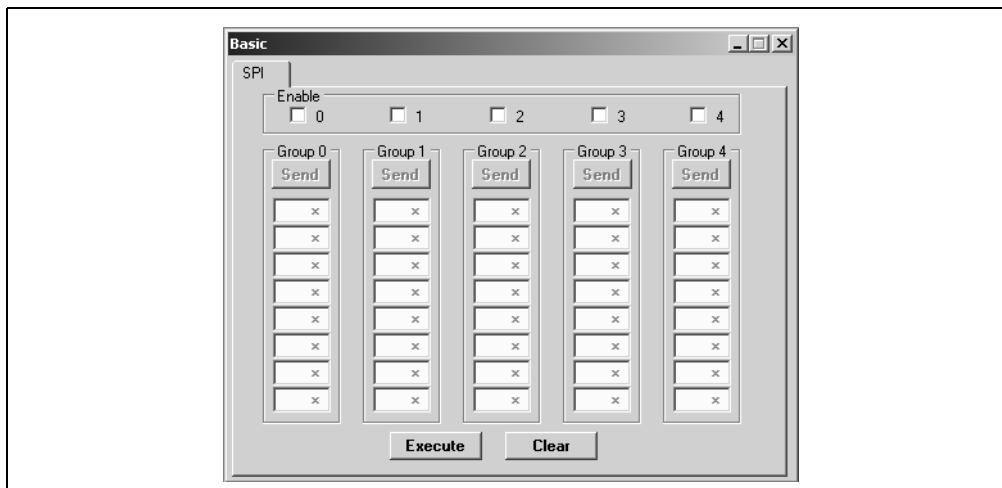
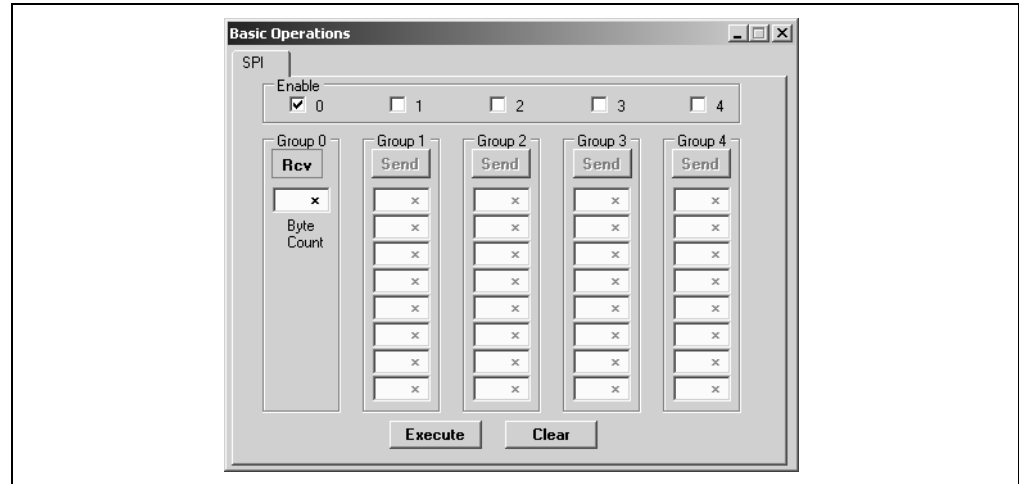

FIGURE 5-4: SPI BASIC OPERATIONS



5.6.1 Basic Communications – Serial EEPROM Example

Figures 5-5 through 5-7 demonstrates how to communicate with a 25LC020A SPI serial EEPROM. Refer to the 25LC020A Data Sheet (DS21833) for a detailed explanation of its SPI communications.

Before data can be written to the 25LC020A, the write enable (WREN) latch must be set. This requires that \overline{CS} be enabled, command 0x06 transmitted, and \overline{CS} disabled. Figure 5-5 shows only Group 0 enabled. All other groups are disabled. Clicking on the **Execute** button will transmit only the WREN command. The command will be logged in the Transactions window.

FIGURE 5-5: SEEPROM EXAMPLE – WREN COMMAND

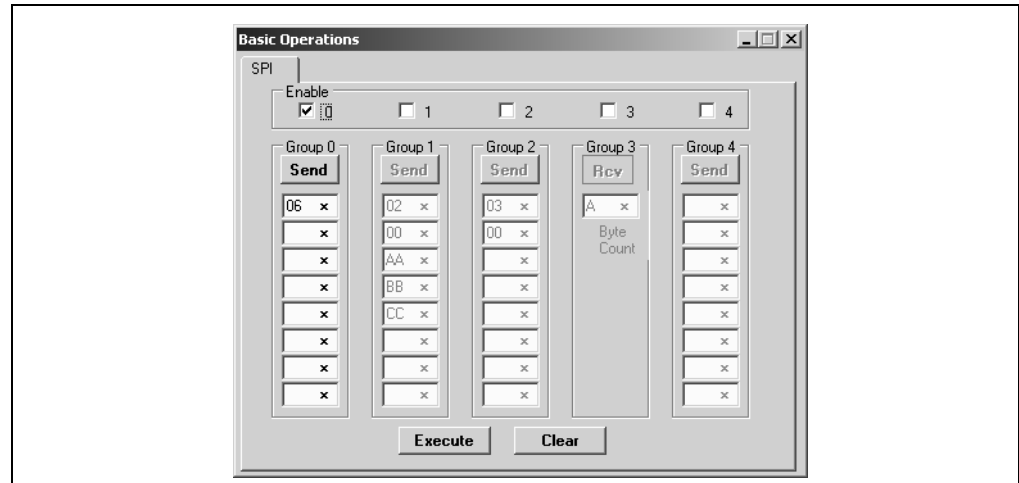

Once the WREN latch has been enabled, data can be written to the 25LC020A. Figure 5-6 shows that Group 0 has been disabled, and Group 1 enabled. Clicking on the **Execute** button will send the Write command (0x02), the memory address (0x00), followed by three bytes of data: 0xAA, 0xBB, and 0xCC. The command will be logged in the Transactions window.

FIGURE 5-6: SEEPROM EXAMPLE – WRITE BYTES

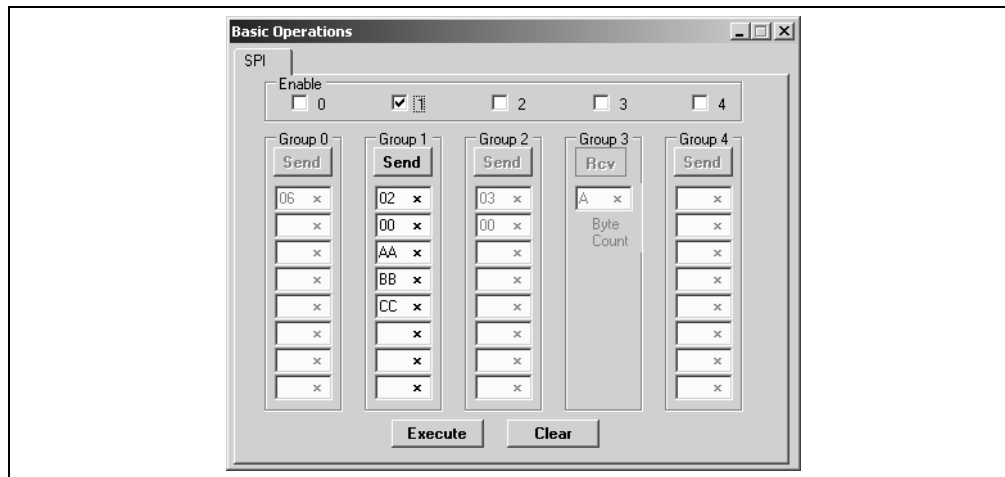
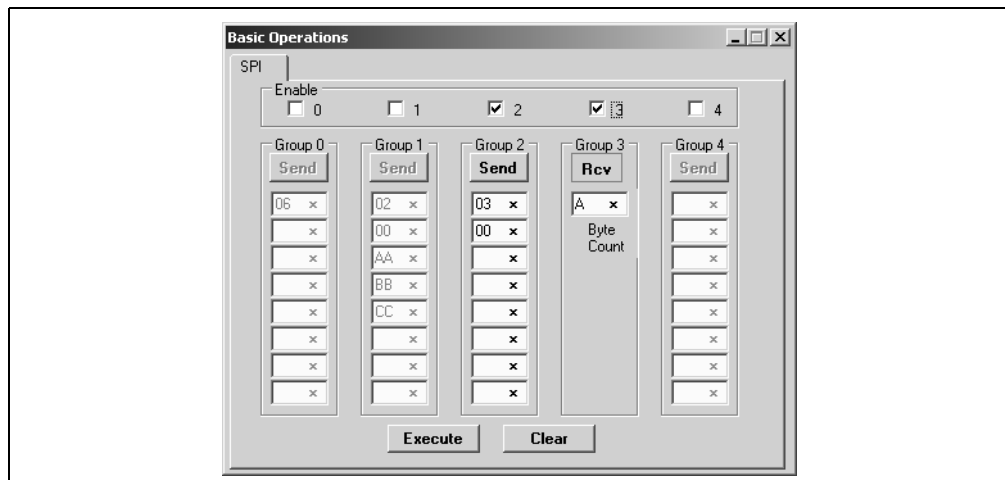

Figure 5-7 shows how to read data from the 25LC020A. Groups 0 and 1 are disabled, and Groups 2 and 3 are enabled. This example shows how data is transmitted and received in one transaction (Chip Select, CS, active) between Groups. Clicking on the **Execute** button will send the Read command (0x03) and memory address (0x00) of Group 2 followed by a Read Ten Bytes command in Group 3. The commands and received data are displayed in the transactions window.

FIGURE 5-7: SEEPROM EXAMPLE – READ BYTES



5.7 SCRIPT BUILDER

SPI commands can be combined into scripts, saved, and used over again. The Script Builder window is opened by selecting *Communications > Script > Script Builder* from the menu bar. The Script Builder is shown in Figure 5-8.

The Script Builder window is divided into four columns as shown in Figures 5-9 through 5-12.

FIGURE 5-8: SPI SCRIPT BUILDER

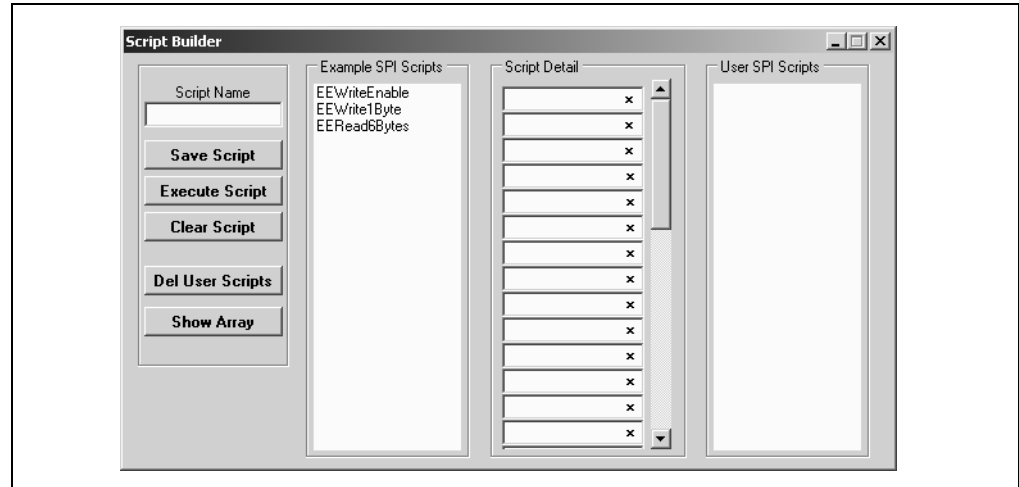

5.7.1 Script Commands

The left most column contains the Script Commands as shown in Figure 5-9.

- Script Name – Enter the name of the script
- Save Script – Saves the script
- Execute Script – Executes (performs) the script displayed in the Script Detail column
- Clear Script – Clears the Script Detail column
- Del User Scripts – Deletes scripts from the User Scripts column.
- Show Array – Displays a spreadsheet-like table in which large amounts of data may be entered. This data can be included in the script by right clicking in a Script Detail cell and choosing “Insert Array”.

FIGURE 5-9: SPI SCRIPT BUILDER – SCRIPT COMMANDS

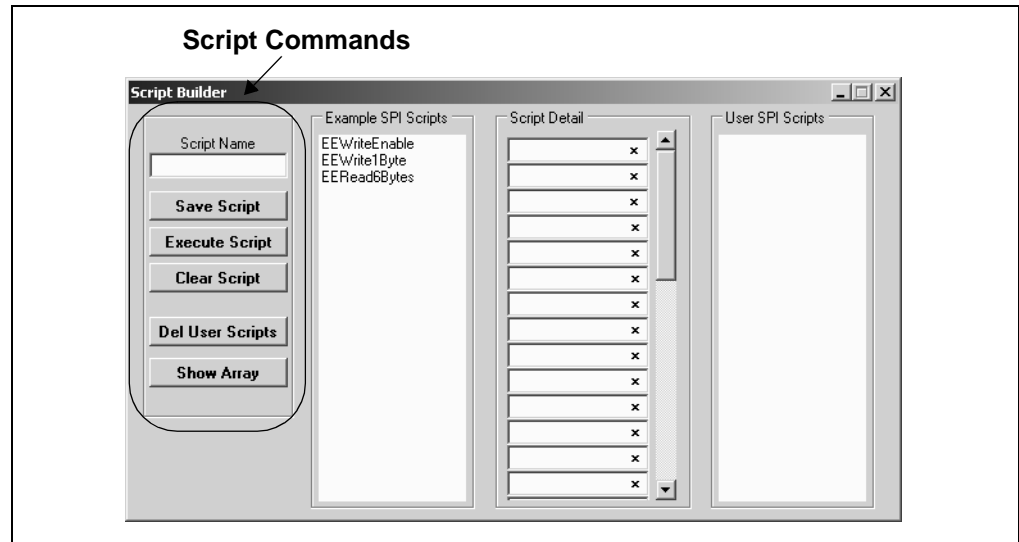

5.7.2 Example Scripts

The second column contains Example Scripts as shown in Figure 5-10. These can be studied to learn how to create or to edit custom scripts. To load the example script into the Script Detail column, either double click or right click and select from the local menu.

FIGURE 5-10: SPI SCRIPT BUILDER – EXAMPLE SCRIPTS

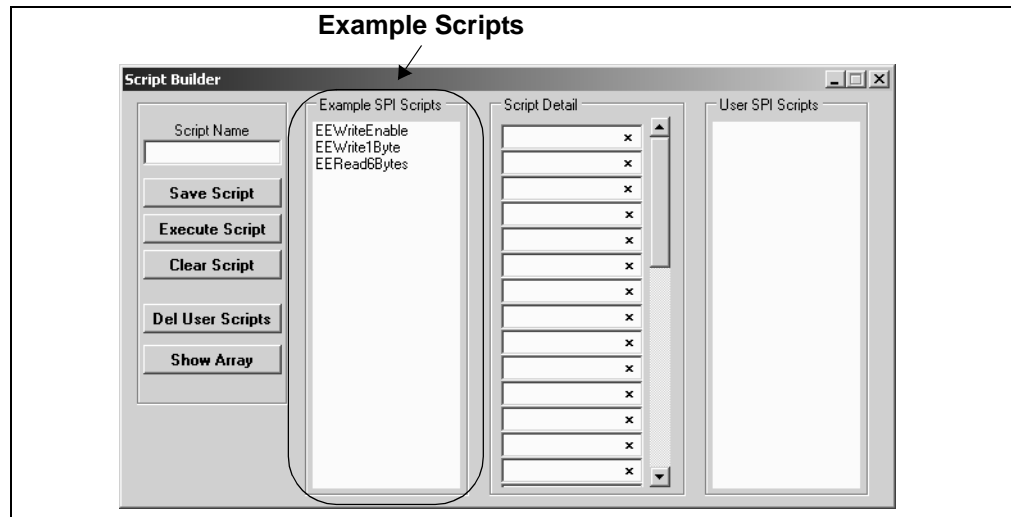

5.7.3 Script Detail

The third column contains Script Detail as shown in Figure 5-11. This column is used to create the script or view an existing script. More information about creating a customer script is discussed in **Section 5.7.5 “Creating A Script”**.

To load a user script from the User Scripts column into the Script Detail column, the user can double click or right click and select from the local menu.

Note: The “x” indicates the value is a hexadecimal number. Clicking on “x” will toggle it to a “d” indicating that the value is a decimal number.

FIGURE 5-11: I²C™ SCRIPT BUILDER – SCRIPT DETAIL

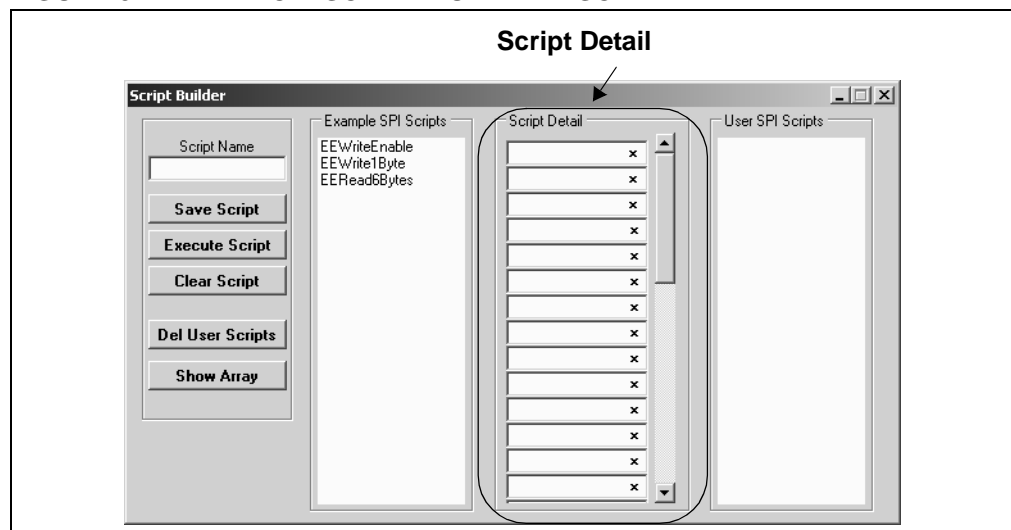

5.7.4 User Scripts

The fourth column contains User Scripts as shown in Figure 5-12. User scripts that are created, named, and saved are displayed in the User Scripts column.

To load a user script from the User Scripts column into the Script Detail column, the user can double click or right click and select from the local menu.

User Scripts can be deleted by right clicking and selecting Delete Script from the local menu.

FIGURE 5-12: SPI SCRIPT BUILDER – USER SCRIPTS

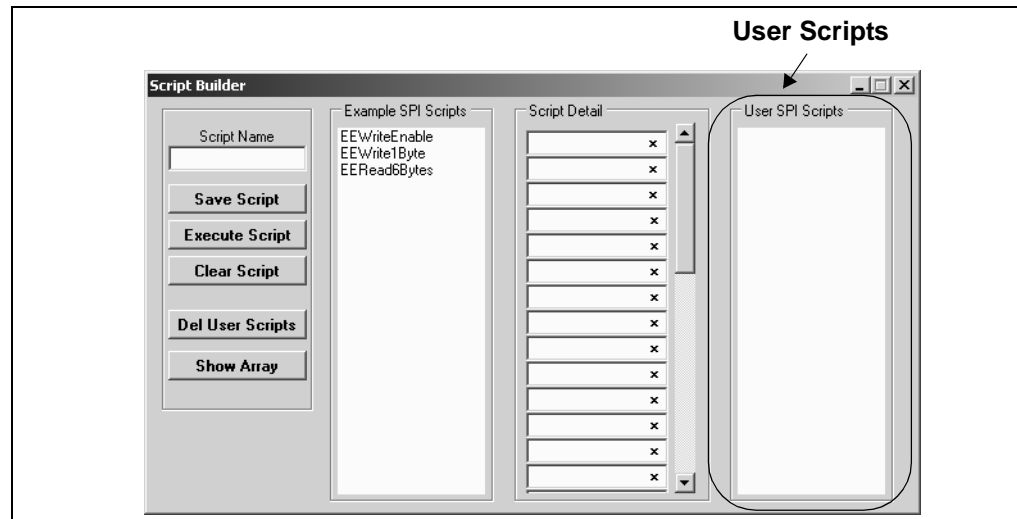

5.7.5 Creating A Script

Scripts are created by placing the cursor into the Script Detail column and right clicking. A local menu will be displayed as shown in Figure 5-13. Select from the choice of commands or script macro commands.

The sequence of macro commands are executed from top to bottom. Macro commands are entered by right clicking in the box and selecting from the local menu as shown in Figure 5-13.

Macro commands are entered according to the sequence of events as defined by the SPI bus protocol. Studying the example scripts is a good way to learn the sequence of events. The example scripts can also be modified and saved under a different name.

CAUTION

The choice of macro commands is very flexible. Therefore, the correctness of the script has to be verified by the user. The PICKit Serial Analyzer program does not verify the correctness of the script.

A complete listing of the available macro commands is given in Table 5-2. The macro command abbreviation will be displayed in the Transactions Window. The Transactions window keeps a running log of the commands and data sent to and from the target device.

FIGURE 5-13: SPI SCRIPT BUILDER – CREATING A SCRIPT

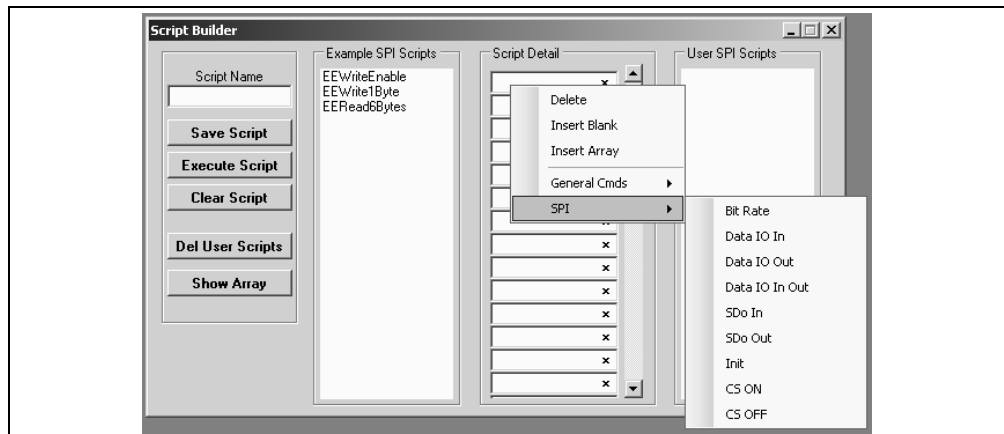

TABLE 5-2: SPI SCRIPT MACRO COMMAND

Macro Command	Command Abbreviation	Description
SPIBITRATE	[BR]	Set Bit Rate. Next byte is the scaler, followed by the pre-scaler.
SPIDATIN	[DI]	Input data. Next byte is the byte count.
SPIDATOUT	[DO]	Output data. Next byte is the byte count, followed by the data.
SPIDATIO	[DIO]	Output data
SPISDOIN	[SI]	Set SDO pin to Input (tri-state)
SPISDOOUT	[SO]	Set SDO pin to Output
SPIINIT	[I_]	Initialize SPI controller
SPICSON	[CSON]	Assert \overline{CS} (active-low)
SPICSOFF	[CSOF]	De-assert \overline{CS} (active-low)

5.8 SCRIPT EXECUTE

The Script Execute window is shown in Figure 5-14. Once scripts are created using the Script Builder, they can be assigned to buttons in the Script Execute window. This makes a convenient window to execute multiple scripts either individually or iteratively. Script executing will be logged in the Transactions window.

FIGURE 5-14: SPI SCRIPT EXECUTE

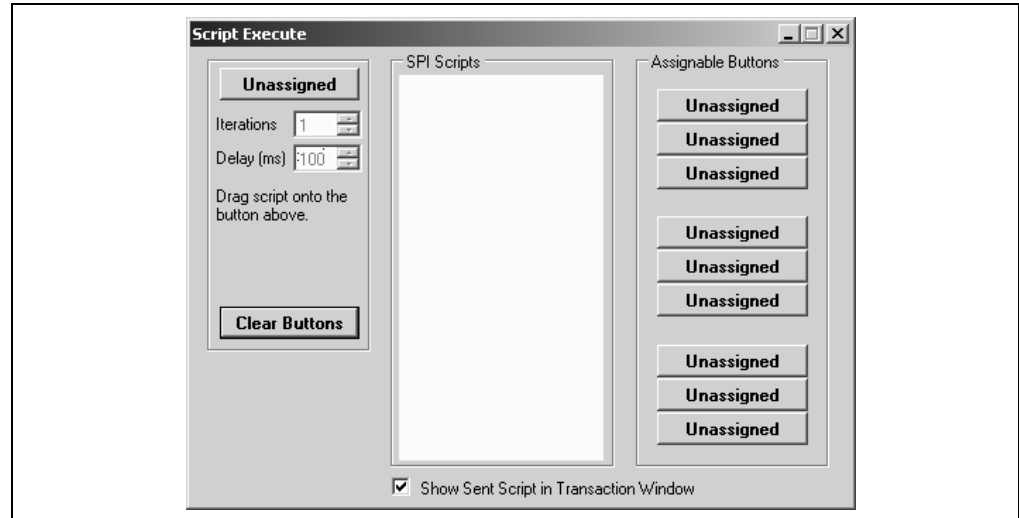

5.8.1 Assignable Buttons

User created scripts will be displayed in the central SPI Scripts column. To assign a script to a button, click on the script name and drag it to the desired Assignable Buttons in the right column. The script will be executed once each time the button is clicked. The Assignable Buttons can be cleared by clicking on the **Clear Buttons** button.

5.8.2 Iteration

Scripts can be executed a user defined number of times at a specified interval of time. Figure 5-15 shows an example. A script named **Read_Memory** has been assigned to the **Iteration** button in the left column. The number of iterations are entered in the Iterations box and the delay in millisecond in the Delay box. A summary of the iterations is displayed in the left column. The macro is executed when the **Iteration** button is clicked.

FIGURE 5-15: SPI SCRIPT EXECUTE – EXAMPLE

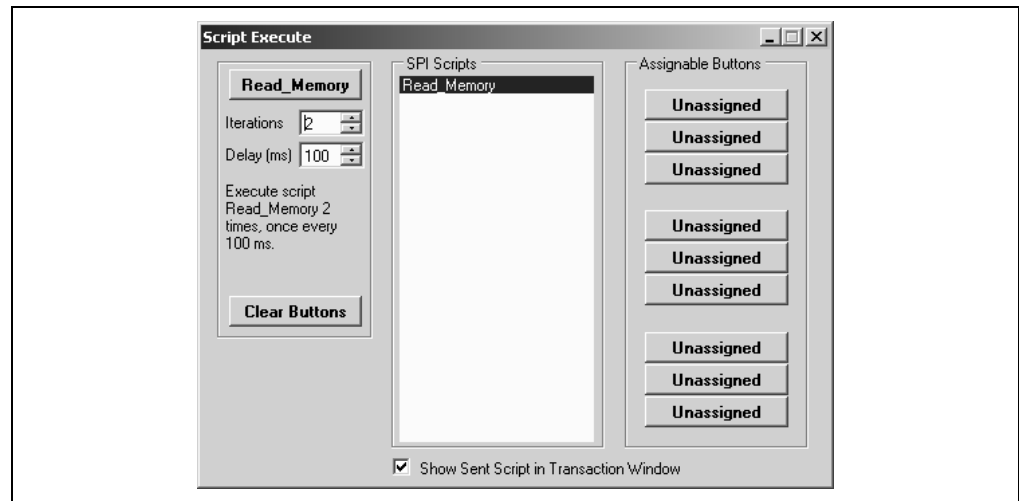

PICkit™ Serial Analyzer User's Guide

NOTES:

Chapter 6. USART Asynchronous Communications

6.1 INTRODUCTION

This chapter describes the USART Asynchronous Communications mode. USART Asynchronous data and commands can be entered using a Basic Communications window or by creating Script Commands.

It is assumed that the user is familiar with the USART Asynchronous protocol. For more information see:

- USART, AUSART, or EUSART chapter of the PIC microcontroller data sheet of interest
- A USART Asynchronous Communications tutorial is available on the Microchip Technology web site. Click on the links: Support -> Getting Started -> PIC MCU Tutorials -> USART - Using in Asynchronous Mode
- Several application notes are available on the Microchip Technology web site. Click on links: Design -> App Notes -> Function: Communication -> USART

6.2 HIGHLIGHTS

This chapter discusses:

- PICKit Serial Pin Assignments
- Selecting Communications Mode
- Configuring USART Asynchronous Communications Mode
- Communications: Basic Operations
- Script Builder
- Script Execute

6.3 PICKit SERIAL PIN ASSIGNMENTS

The PICKit Serial Analyzer pin assignments for USART Asynchronous Communications mode are:

TABLE 6-1: USART ASYNCHRONOUS PIN ASSIGNMENTS

Pin	Label	Type	Description
1	TX	Output	Transmit Data (with respect to the PICKit™ Serial Analyzer)
2	+V	Power	Target Power
3	GND	Power	Ground
4	AUX1	Input/Output	Auxiliary I/O port pin No. 1
5	AUX2	Input/Output	Auxiliary I/O port pin No. 2
6	RX	Input	Receive Data (with respect to the PICKit™ Serial Analyzer)

PICkit™ Serial Analyzer User's Guide

6.4 SELECTING COMMUNICATIONS MODE

The USART Asynchronous Communications mode is selected from the Configuration Wizard or menu bar.

Configuration Wizard – Select *PICkit Serial Analyzer > Run Configuration Wizard* from the menu bar

Menu Bar – Select *PICkit Serial Analyzer > Select Communications Mode > USART Asynchronous*

6.5 CONFIGURING USART ASYNCHRONOUS COMMUNICATIONS MODE

Once the communications mode has been selected, it is configured from the Configuration Wizard or menu bar.

Configuration Wizard – Select *PICkit Serial Analyzer > Run Configuration Wizard* from the menu bar

Menu Bar – Select *PICkit Serial Analyzer > Configure Communications Mode*

The Configure Mode window will open. Depending on the view selected, the Basic View (Figure 6-1) displays a minimum choice of configurations commands. In the Advanced View (Figure 6-2) displays an extended choice of configuration commands.

Save the configuration by clicking on the **Save Changes** button.

FIGURE 6-1: USART ASYNCHRONOUS CONFIGURE COMMUNICATIONS MODE – BASIC VIEW

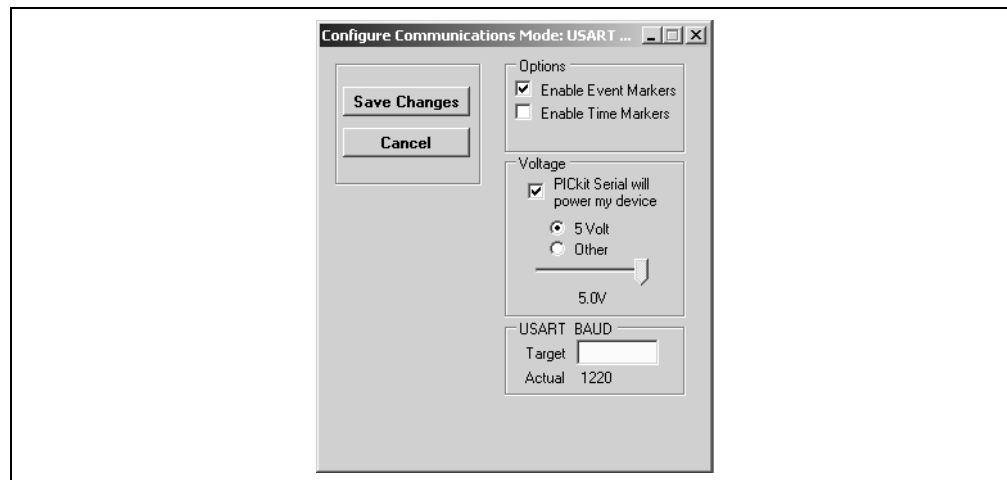

OPTIONS

- Enable Event Markers – Enable event markers
- Enable Time Markers – Enable 'time' stamp to accompany all event markers

VOLTAGE

- PICkit Serial will power my device – Select the check box if the PICkit Serial will power the target device. The target can be powered at 5 VDC or a user selectable variable voltage.

CAUTION

Even though the voltage can be set as low as 0 VDC, it is up to the user to verify the required operating voltage of the target device.

USART Asynchronous Communications

CAUTION

The USB port current limit is set to 100 mA. If the target plus PICKit Serial Analyzer exceeds this current limit, the USB port will turn off. The target may be powered externally if more power is required.

USART BAUD

Enter the desired USART symbol rate (Baud) in the text box.

FIGURE 6-2: USART ASYNCHRONOUS CONFIGURE COMMUNICATIONS MODE – ADVANCED VIEW

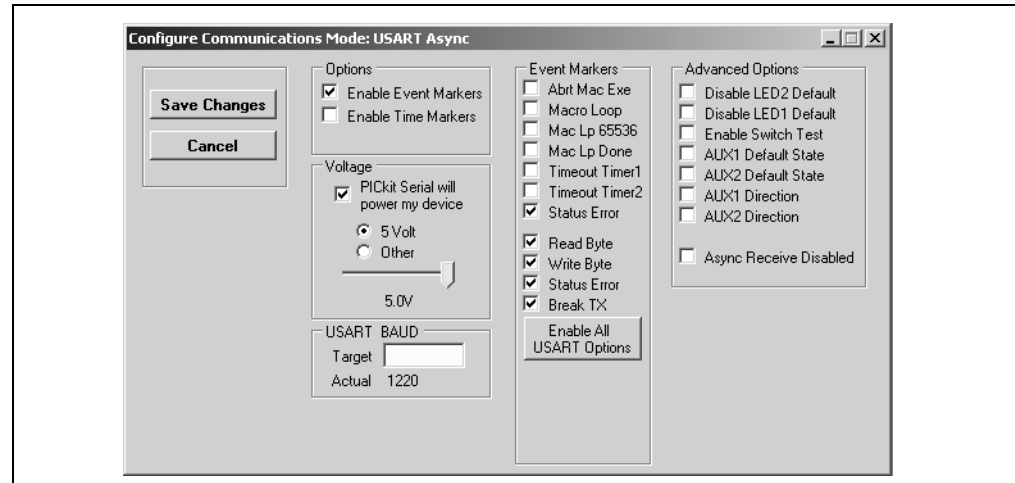

EVENT MARKERS

- Abt Mac Exe – Enable event marker: abort ‘macro’ execution
- Macro Loop – Enable event marker: top of ‘macro’ loop
- Mac Lp 65536 – Enable event marker: ‘macro’ loop count overflow (i.e., 65536)
- Mac Lp Done – Enable event marker: ‘macro’ loop iterations complete
- Timeout Timer1 – Enable event marker: Timer1 expired
- Timeout Timer2 – Enable event marker: Timer2 expired
- Status Error – Enable event marker: change in status byte
- Read Byte – Enable event marker – read byte
- Write Byte – Enable event marker – write byte
- Status Error – Enable event marker – change in USART status byte
- Break TX – Enable event marker – A “Break” has been transmitted

ADVANCED OPTIONS

- Disable LED2 Default – Disable default LED2 behavior (LED2 = Yellow ‘Target’ LED)
- Disable LED1 Default – Disable default LED1 behavior (LED1 = Red ‘Busy’ LED)
- Enable Switch Test – Enable low level switch test:
- AUX1 Default State – AUX1 communication line – default state (0 | 1)
- AUX2 Default State – AUX2 communication line – default state (0 | 1)
- AUX1 Direction – AUX1 communication line – direction: 1: input, 0: output
- AUX2 Direction – AUX2 communication line – direction: 1: input, 0: output
- Async Receive Disabled – Received Data is disabled

6.6 COMMUNICATIONS: BASIC OPERATIONS

The USART Asynchronous Operations window can be opened by selecting:

- *Communications: Basic Operations* from the tool bar, or
- *Communications > Basic Operations* from the menu bar

The USART Asynchronous Basic Operations window is shown in Figure 6-3. There are two basic communications commands, Read and Write.

Data can be transmitted to the target device as 7-bit ASCII or 8-bit byte. 7-bit ASCII data is entered in the left hand window. 8-bit byte is entered in the right hand column.

Both transmitted and received data is displayed in the Transaction window.

Note: The “x” indicates the value is a hexadecimal number. Clicking on “x” will toggle it to a “d” indicating that the value is a decimal number.

The command will be logged in the Transactions window. A listing of the command abbreviations is given in Table 6-2.

FIGURE 6-3: USART ASYNCHRONOUS BASIC OPERATIONS

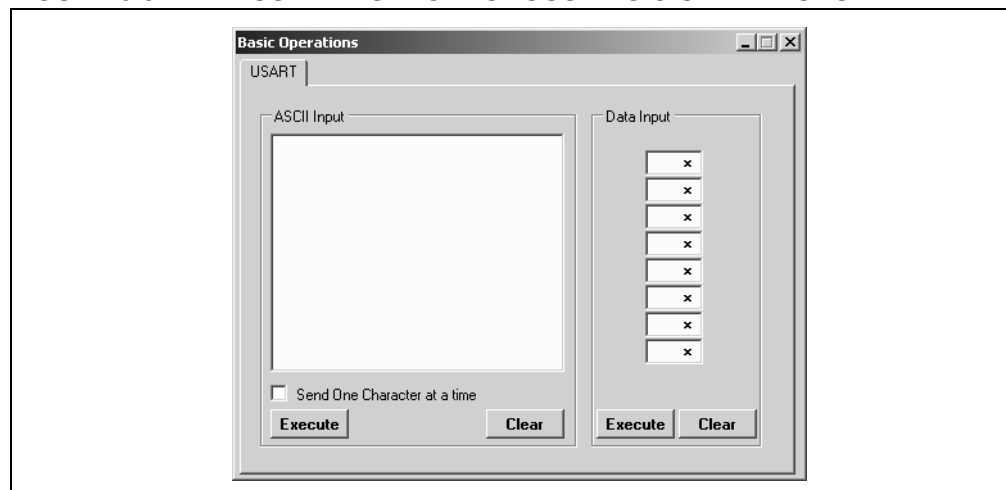

6.7 SCRIPT BUILDER

USART Asynchronous commands can be combined into scripts, saved, and used over again. The Script Builder window is opened by selecting *Communications > Script > Script Builder* from the menu bar. The Script Builder is shown in Figure 6-4.

The Script Builder window is divided into four columns as shown in Figures 6-5 through 6-8.

USART Asynchronous Communications

FIGURE 6-4: USART ASYNCHRONOUS SCRIPT BUILDER

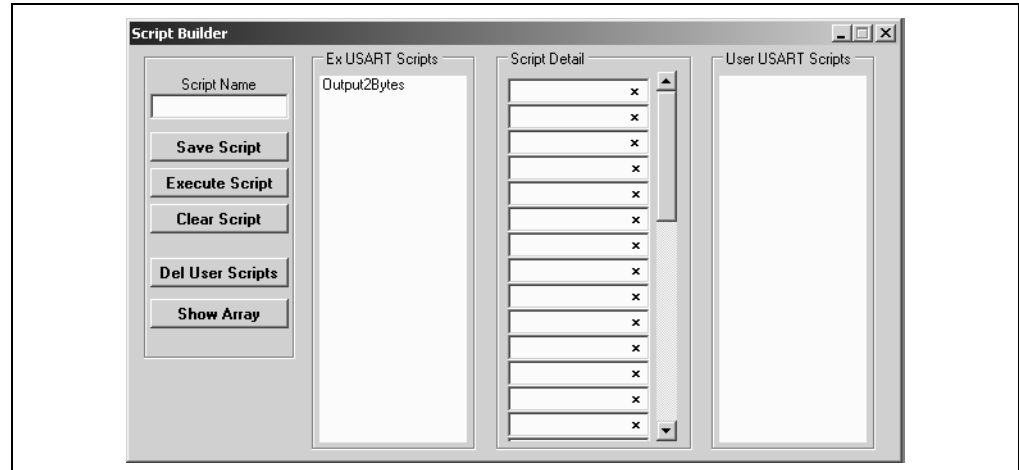

6.7.1 Script Commands

The left most column contains the Script Commands as shown in Figure 6-5.

- Script Name – Enter the name of the script
- Save Script – Saves the script
- Execute Script – Executes (performs) the script displayed in the Script Detail column
- Clear Script – Clears the Script Detail column
- Del User Scripts – Deletes scripts from the User Scripts column.
- Show Array – Displays a spreadsheet-like table in which large amounts of data may be entered. This data can be included in the script by right clicking in a Script Detail cell and choosing “Insert Array”.

FIGURE 6-5: USART ASYNCHRONOUS SCRIPT BUILDER – SCRIPT COMMANDS

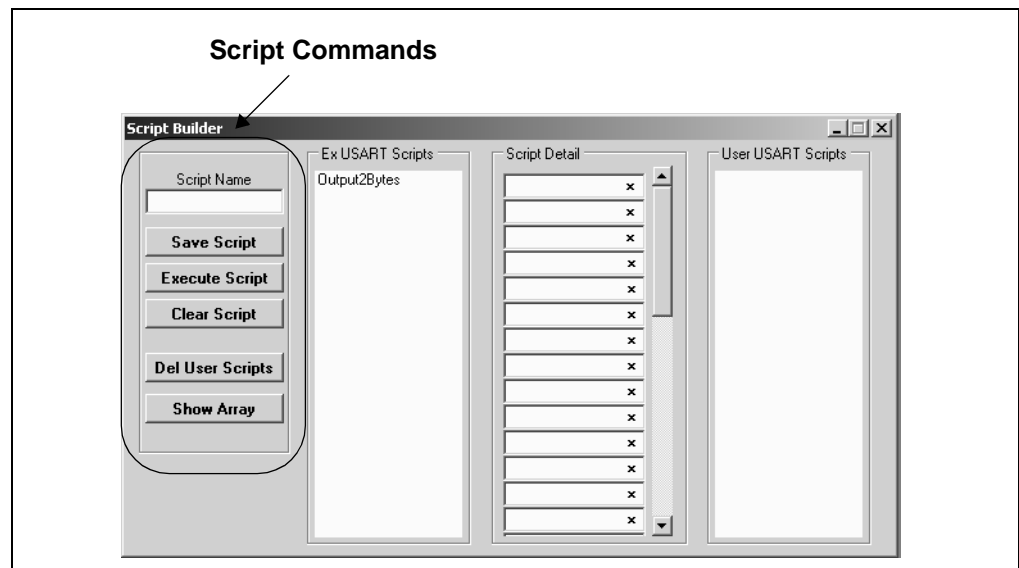

6.7.2 Example Scripts

The second column contains Example Scripts as shown in Figure 6-6. These can be studied to learn how to create or to edit custom scripts. To load the example script into the Script Detail column, either double click or right click and select from the local menu.

FIGURE 6-6: USART ASYNCHRONOUS SCRIPT BUILDER – EXAMPLE SCRIPTS

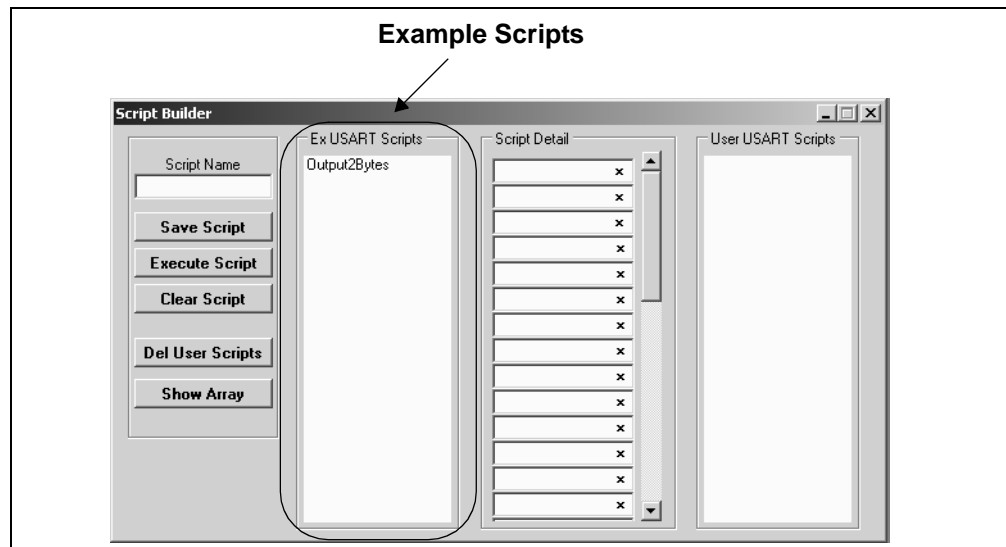

6.7.3 Script Detail

The third column contains Script Detail as shown in Figure 6-7. This column is used to create the script or view an existing script. More information about creating a customer script is discussed in **Section 6.7.5 “Creating A Script”**.

To load a user script from the User Scripts column into the Script Detail column, the user can double click or right click and select from the local menu.

Note: The “x” indicates the value is a hexadecimal number. Clicking on “x” will toggle it to a “d” indicating that the value is a decimal number.

USART Asynchronous Communications

FIGURE 6-7: USART ASYNCHRONOUS SCRIPT BUILDER – SCRIPT DETAIL

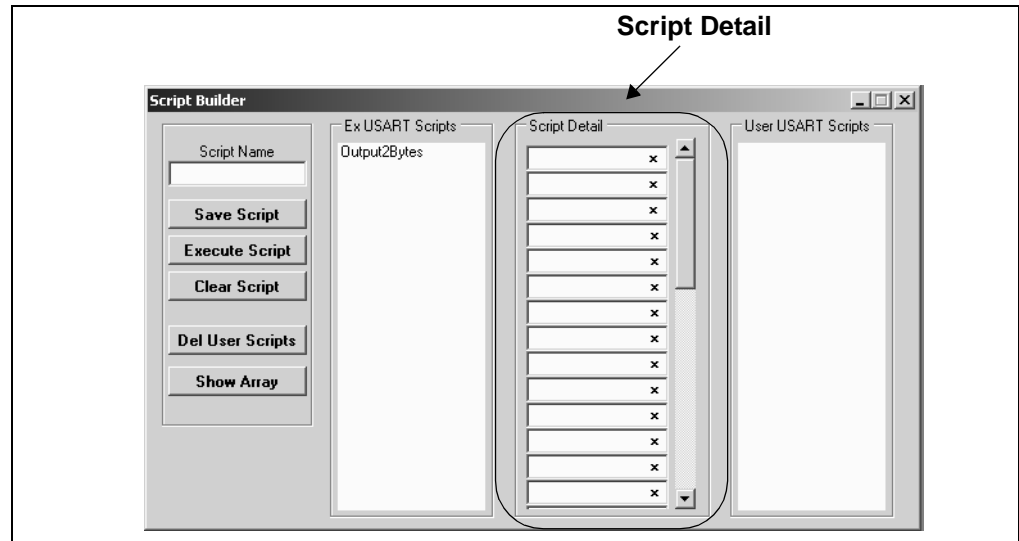

6.7.4 User Scripts

The fourth column contains User Scripts as shown in Figure 6-8. User scripts that are created, named, and saved are displayed in the User Scripts column.

To load a user script from the User Scripts column into the Script Detail column, the user can double click or right click and select from the local menu.

User Scripts can be deleted by right clicking and selecting Delete Script from the local menu.

FIGURE 6-8: USART ASYNCHRONOUS SCRIPT BUILDER – USER SCRIPTS

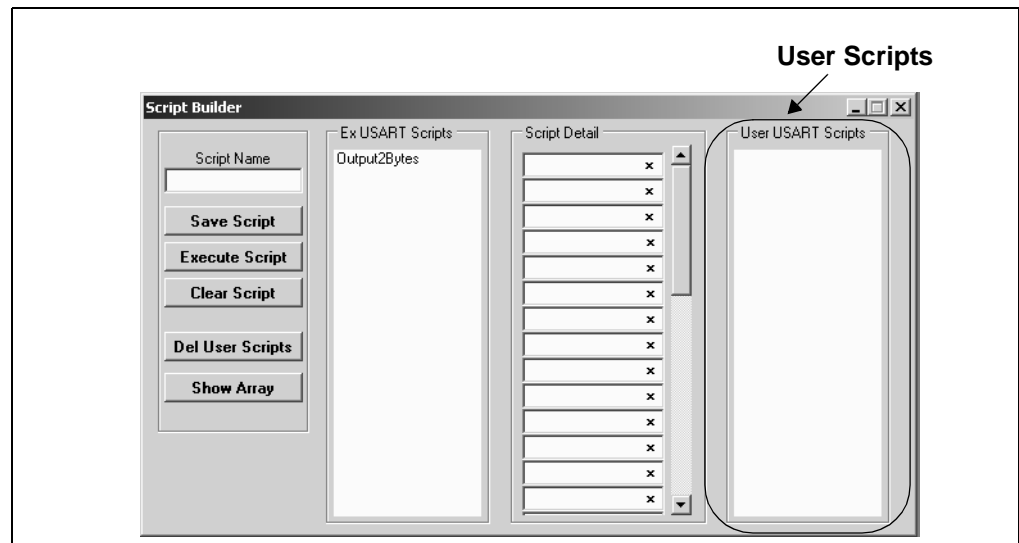

6.7.5 Creating A Script

Scripts are created by placing the cursor into the Script Detail column and right clicking. A local menu will be displayed as shown in Figure 6-9. Select from the choice of commands or script macro commands.

PICkit™ Serial Analyzer User's Guide

The sequence of macro commands are executed from top to bottom. Macro commands are entered by right clicking in the box and selecting from the local menu as shown in Figure 6-9.

Macro commands are entered according to the sequence of events as defined by the USART Asynchronous protocol. Studying the example scripts is a good way to learn the sequence of events. The example scripts can also be modified and saved under a different name.

CAUTION

The choice of macro commands is very flexible. Therefore, the correctness of the script has to be verified by the user. The PICkit Serial Analyzer program does not verify the correctness of the script.

A complete listing of the available macro commands is given in Table 6-2. The macro command abbreviation will be displayed in the Transactions Window. The Transactions window keeps a running log of the commands and data sent to and from the target device.

FIGURE 6-9: USART ASYNCHRONOUS SCRIPT BUILDER – CREATING A SCRIPT

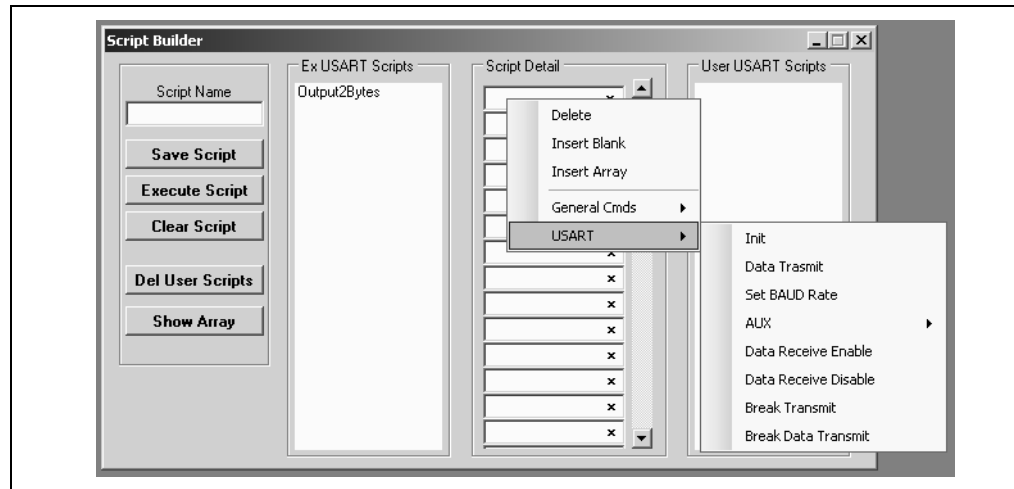

TABLE 6-2: USART SCRIPT MACRO COMMANDS

Macro Command	Command Abbreviation	Description
USDATATX	[TX]	Transmit data. Next byte is the byte count, followed by the data.
USDATARX	[RX]	Receive data. Next byte is the byte count.
USDATARXEN	[ER]	Enable Receive data monitor
USDATARXDS	[DR]	Disable Receive data monitor
USBREAKTX	[BK]	Send Break
USBRKDATTX	[BKD]	Send Break, then data byte. Next byte is the data byte.
USBAUD	[BD]	Set BAUD Rate. Next byte is BAUD (LSB) followed by BAUD (MSB).
US9BITSET	[9S]	Set 9-bit Data mode
US9BITRST	[9R]	Reset 9-bit Data mode (sets 8-bit)
USCLKPOLSET	[CS]	Set CLOCK POLARITY bit

USART Asynchronous Communications

TABLE 6-2: USART SCRIPT MACRO COMMANDS (CONTINUED)

USCLKPOLRST	[CR]	Reset CLOCK POLARITY bit
USINIT	[L_]	Initialize USART controller
USRESET	[RE]	Reset USART controller.
USAUX1RST	[A1RST]	Reset Aux1
USAUX1SET	[A1RST]	Set Aux1
USAUX1OUT	[A1OUT]	Set Aux1 direction to Output
USAUX1IN	[A1IN]	Set Aux1 direction to Input
USAUX1W0	[A1W0]	Aux1 Wait 0
USAUX1W1	[A1W1]	Aux1 Wait 1
USAUX2RST	[A2RST]	Reset Aux2
USAUX2SET	[A2RST]	Set Aux2
USAUX2OUT	[A2OUT]	Set Aux2 direction to Output
USAUX2IN	[A2IN]	Set Aux2 direction to Input
USAUX2W0	[A2W0]	Aux2 Wait 0
USAUX2W1	[A2W1]	Aux2 Wait 1

6.8 SCRIPT EXECUTE

The Script Execute window is shown in Figure 6-10. Once scripts are created using the Script Builder, they can be assigned to buttons in the Script Execute window. This makes a convenient window to execute multiple scripts either individually or iteratively. Script executing will be logged in the Transactions window.

FIGURE 6-10: USART ASYNCHRONOUS SCRIPT EXECUTE

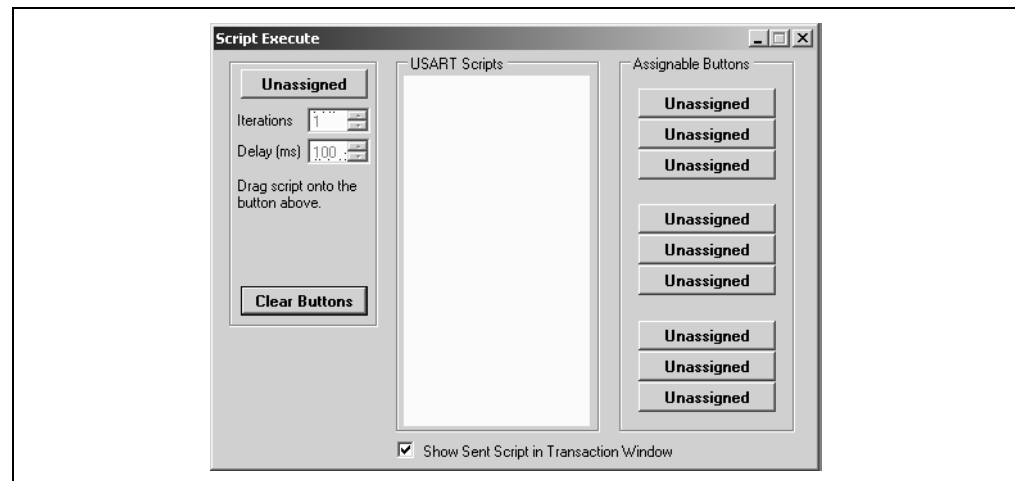

6.8.1 Assignable Buttons

User created scripts will be displayed in the central USART Scripts column. To assign a script to a button, click on the script name and drag it to the desired Assignable Buttons in the right column. The script will be executed once each time the button is clicked.

The Assignable Buttons can be cleared by clicking on the **Clear Buttons** button.

6.8.2 Iteration

Scripts can be executed a user defined number of times at a specified interval of time. Figure 6-11 shows an example. A script named TX_Data has been assigned to the **Iteration** button in the left column. The number of iterations is entered in the Iterations box and the delay in milliseconds in the Delay box. A summary of the iterations is displayed in the left column. The macro is executed when the **Iteration** button is clicked.

FIGURE 6-11: USART ASYNCHRONOUS SCRIPT EXECUTE – EXAMPLE

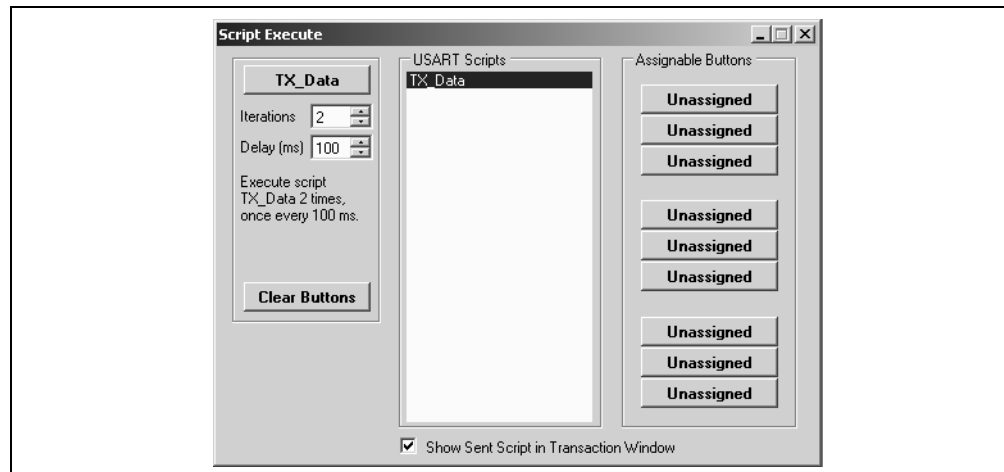

Chapter 7. USART Master Synchronous Communications

7.1 INTRODUCTION

This chapter describes the USART Synchronous Master Communications mode. USART Synchronous Master data and commands can be entered using a Basic Communications window or by creating Script Commands.

It is assumed that the user is familiar with the USART Synchronous protocol. For more information see:

- USART, AUSART, or EUSART chapter of the PIC microcontroller data sheet of interest

7.2 HIGHLIGHTS

This chapter discusses:

- PICKit Serial Pin Assignments
- Selecting Communications Mode
- Configuring USART Synchronous Master Communications Mode
- Communications: Basic Operations
- Script Builder
- Script Execute

7.3 PICKit SERIAL PIN ASSIGNMENTS

The PICKit Serial Analyzer pin assignments for USART Synchronous Master Communications mode are:

TABLE 7-1: USART SYNCHRONOUS MASTER PIN ASSIGNMENTS

Pin	Label	Type	Description
1	CK	Output	Clock
2	+V	Power	Target Power
3	GND	Power	Ground
4	AUX1	Input/Output	Auxiliary I/O port pin No. 1
5	AUX2	Input/Output	Auxiliary I/O port pin No. 2
6	DT	Input/Output	Data

7.4 SELECTING COMMUNICATIONS MODE

The USART Synchronous Master Communications mode is selected from the Configuration Wizard or menu bar.

Configuration Wizard – Select *PICKit Serial Analyzer > Run Configuration Wizard* from the menu bar

Menu Bar – Select *PICKit Serial Analyzer > Select Communications Mode > USART Synchronous Master*

7.5 CONFIGURING USART SYNCHRONOUS MASTER COMMUNICATIONS MODE

Once the communications mode has been selected, it is configured from the Configuration Wizard or menu bar.

Configuration Wizard – Select *PICKit Serial Analyzer > Run Configuration Wizard* from the menu bar

Menu Bar – Select *PICKit Serial Analyzer > Configure Communications Mode*

The Configure Mode window will open. Depending on the view selected, the Basic View (Figure 7-1) displays a minimum choice of configurations commands. In the Advanced View (Figure 7-2) displays an extended choice of configuration commands.

Save the configuration by clicking on the **Save Changes** button.

FIGURE 7-1: USART SYNCHRONOUS MASTER CONFIGURE COMMUNICATIONS MODE – BASIC VIEW

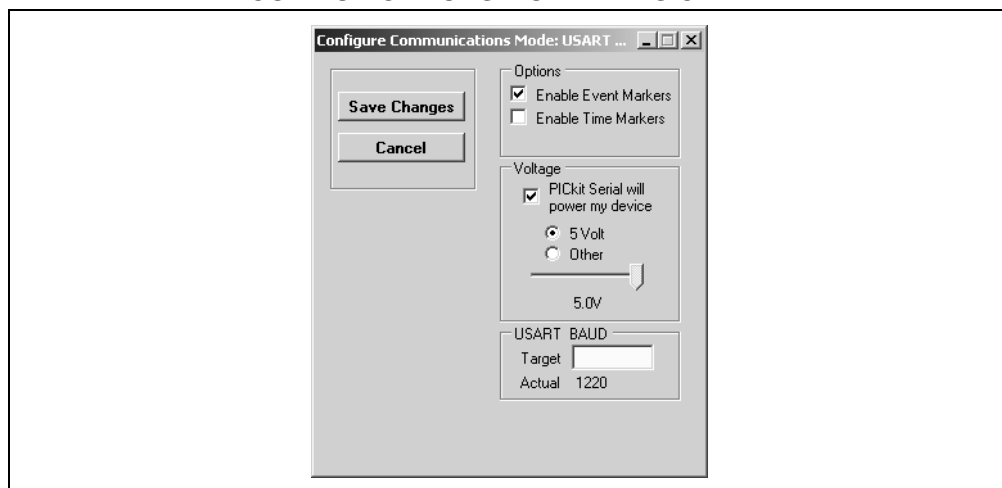

OPTIONS

- Enable Event Markers – Enable event markers
- Enable Time Markers – Enable 'time' stamp to accompany all event markers

VOLTAGE

- PICKit Serial will power my device – Select the check box if the PICKit Serial will power the target device. The target can be powered at 5 VDC or a user selectable variable voltage.

CAUTION

Even though the voltage can be set as low as 0 VDC, it is up to the user to verify the required operating voltage of the target device.

CAUTION

The USB port current limit is set to 100 mA. If the target plus PICKit Serial Analyzer exceeds this current limit, the USB port will turn off. The target may be powered externally if more power is required.

USART Master Synchronous Communications

USART BAUD

Enter the desired USART symbol rate (Baud) in the text box.

FIGURE 7-2: USART SYNCHRONOUS MASTER CONFIGURE COMMUNICATIONS MODE – ADVANCED VIEW

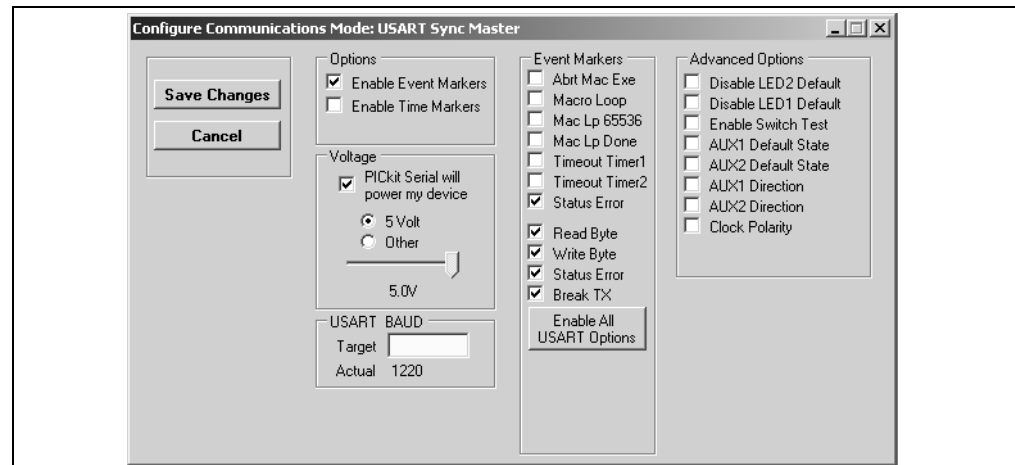

EVENT MARKERS

- Abt Mac Exe – Enable event marker: abort ‘macro’ execution
- Macro Loop – Enable event marker: top of ‘macro’ loop
- Mac Lp 65536 – Enable event marker: ‘macro’ loop count overflow (i.e., 65536)
- Mac Lp Done – Enable event marker: ‘macro’ loop iterations complete
- Timeout Timer1 – Enable event marker: Timer1 expired
- Timeout Timer2 – Enable event marker: Timer2 expired
- Status Error – Enable event marker: change in status byte
- Read Byte – Enable event marker – read byte
- Write Byte – Enable event marker – write byte
- Status Error – Enable event marker – change in USART status byte
- Break TX – Enable event marker – A “Break” has been transmitted

ADVANCED OPTIONS

- Disable LED2 Default – Disable default LED2 behavior (LED2 = Yellow ‘Target’ LED)
- Disable LED1 Default – Disable default LED1 behavior (LED1 = Red ‘Busy’ LED)
- Enable Switch Test – Enable low level switch test:
 - Switch Off (not depressed) – blink LED1, LED2 off
 - Switch ON (depressed) – blink LED2, LED1 off
- AUX1 Default State – AUX1 communication line – default state (0 | 1)
- AUX2 Default State – AUX2 communication line – default state (0 | 1)
- AUX1 Direction – AUX1 communication line – direction: 1: input, 0: output
- AUX2 Direction – AUX2 communication line – direction: 1: input, 0: output
- Clock Polarity – Checked means the polarity is inverted, unchecked means it is not

7.6 COMMUNICATIONS: BASIC OPERATIONS

The USART Asynchronous Operations window can be opened by selecting:

- *Communications: Basic Operations* from the tool bar, or
- *Communications > Basic Operations* from the menu bar

The USART Synchronous Master Basic Operations window is shown in Figure 7-3. There are two basic communications commands, Read and Write.

Data can be transmitted to the target device as 7-bit ASCII or 8-bit byte. 7-bit ASCII data is entered in the left hand window. 8-bit byte is entered in the right hand column.

Both transmitted and received data is displayed in the transaction window.

Note: The “x” indicates the value is a hexadecimal number. Clicking on “x” will toggle it to a “d” indicating that the value is a decimal number.

The command will be logged in the Transactions window. A listing of the command abbreviations is given in Table 7-2.

FIGURE 7-3: USART SYNCHRONOUS MASTER BASIC OPERATIONS

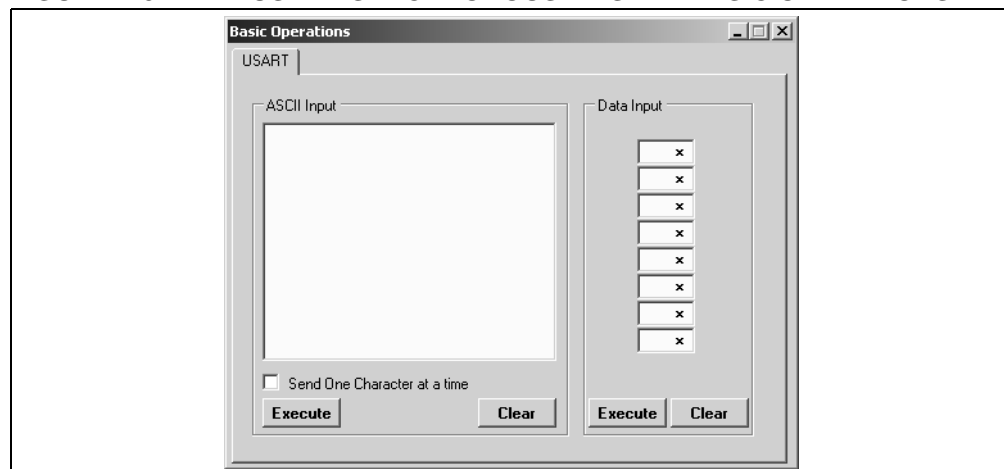

7.7 SCRIPT BUILDER

USART Asynchronous commands can be combined into scripts, saved, and used over again. The Script Builder window is opened by selecting *Communications > Script > Script Builder* from the menu bar. The Script Builder is shown in Figure 7-4.

The Script Builder window is divided into four columns as shown in Figures 7-5 through 7-8.

USART Master Synchronous Communications

FIGURE 7-4: USART SYNCHRONOUS MASTER SCRIPT BUILDER

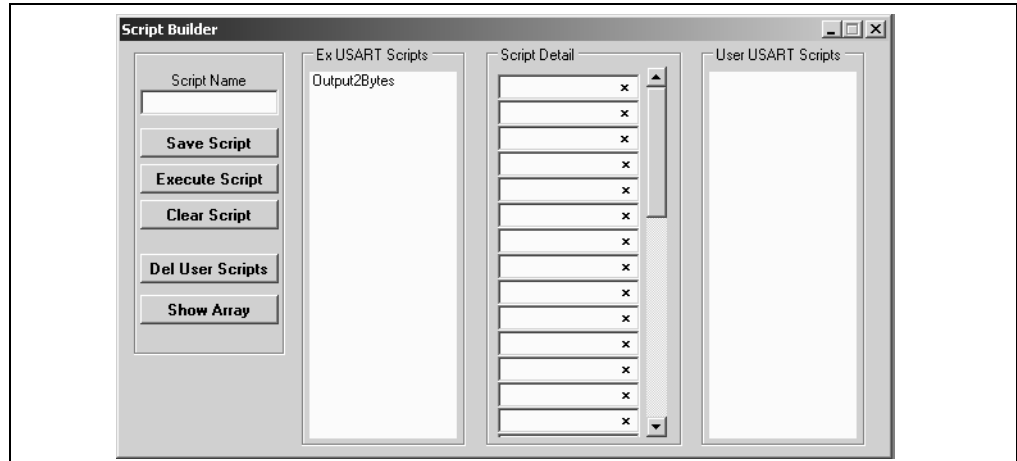

7.7.1 Script Commands

The left most column contains the Script Commands as shown in Figure 7-5.

- **Script Name** – Enter the name of the script
- **Save Script** – Saves the script
- **Execute Script** – Executes (performs) the script displayed in the Script Detail column
- **Clear Script** – Clears the Script Detail column
- **Del User Scripts** – Deletes scripts from the User Scripts column
- **Show Array** – Displays a spreadsheet-like table in which large amounts of data may be entered. This data can be included in the script by right clicking in a Script Detail cell and choosing “Insert Array”.

FIGURE 7-5: USART SYNCHRONOUS MASTER SCRIPT BUILDER – SCRIPT COMMANDS

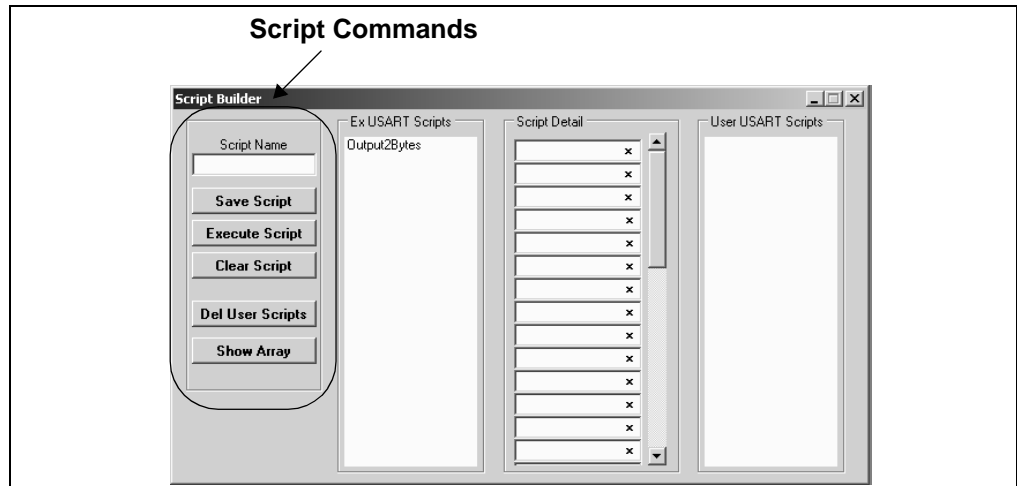

7.7.2 Example Scripts

The second column contains Example Scripts as shown in Figure 7-6. These can be studied to learn how to create or to edit custom scripts. To load the example script into the Script Detail column, either double click or right click and select from the local menu.

FIGURE 7-6: USART SYNCHRONOUS MASTER SCRIPT BUILDER – EXAMPLE SCRIPTS

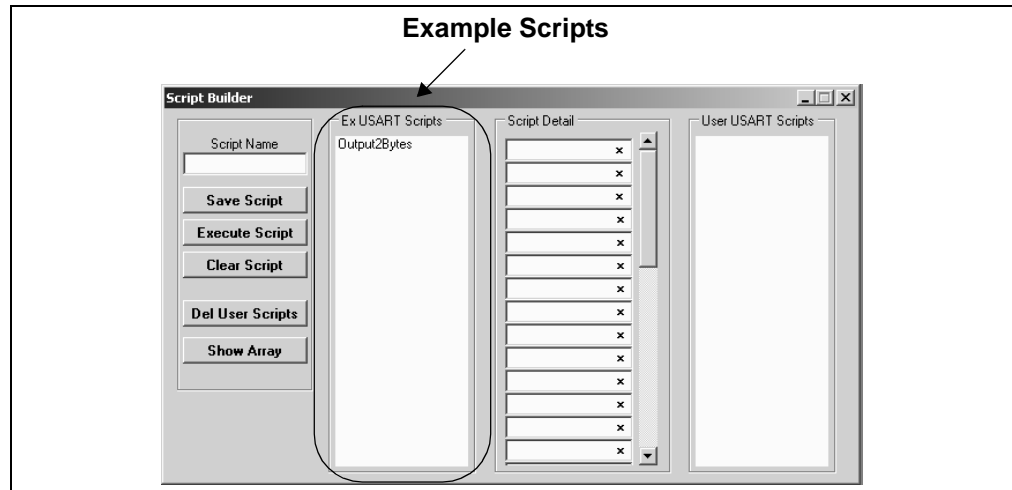

7.7.3 Script Detail

The third column contains Script Detail as shown in Figure 7-7. This column is used to create the script or view an existing script. More information about creating a customer script is discussed in **Section 7.7.5 “Creating a Script”**.

To load a user script from the User Scripts column into the Script Detail column, the user can double click or right click and select from the local menu.

Note: The “x” indicates the value is a hexadecimal number. Clicking on “x” will toggle it to a “d” indicating that the value is a decimal number.

FIGURE 7-7: USART SYNCHRONOUS MASTER SCRIPT BUILDER – SCRIPT DETAIL

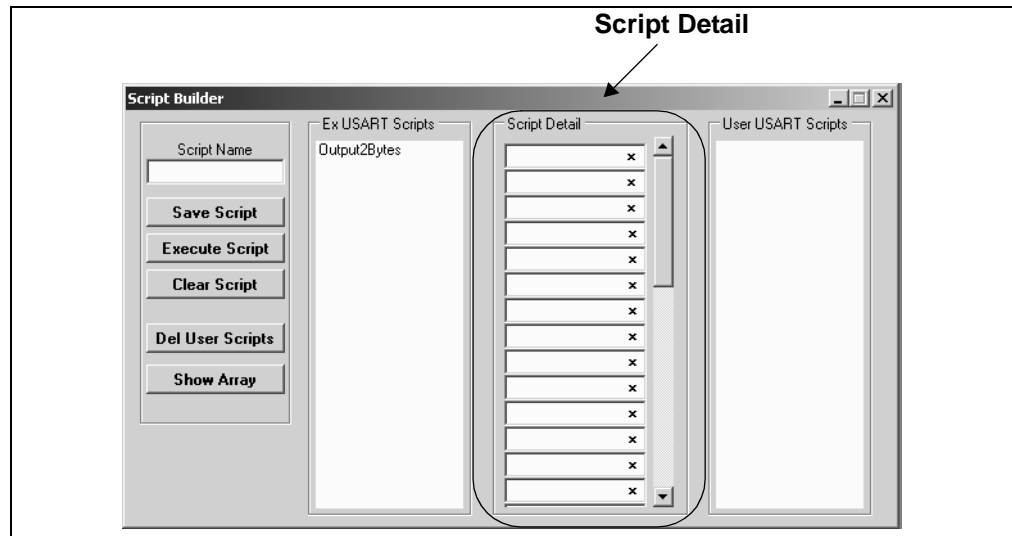

7.7.4 User Scripts

The fourth column contains User Scripts Detail as shown in Figure 7-8. User scripts that are created, named, and saved are displayed in the User Scripts column.

To load a user script from the User Scripts column into the Script Detail column, the user can double click or right click and select from the local menu.

USART Master Synchronous Communications

User Scripts can be deleted by right clicking and selecting Delete Script from the local menu.

FIGURE 7-8: USART SYNCHRONOUS MASTER SCRIPT BUILDER – USER SCRIPTS

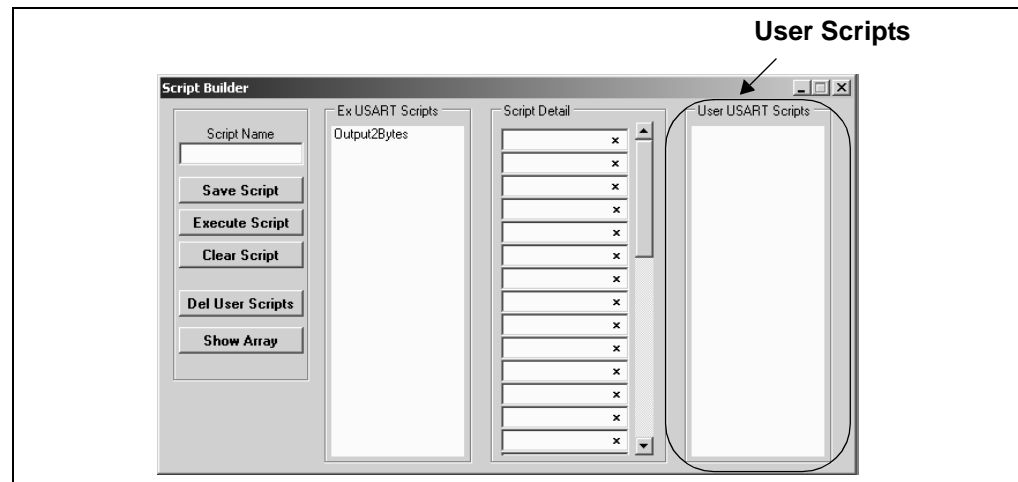

7.7.5 Creating a Script

Scripts are created by placing the cursor into the Script Detail column and right clicking. A local menu will be displayed as shown in Figure 7-9. Select from the choice of commands or script macro commands.

The sequence of macro commands are executed from top to bottom. Macro commands are entered by right clicking in the box and selecting from the local menu as shown in Figure 7-9.

Macro commands are entered according to the sequence of events as defined by the USART Synchronous Master protocol. Studying the example scripts is a good way to learn the sequence of events. The example scripts can also be modified and saved under a different name.

CAUTION

The choice of macro commands is very flexible. Therefore, the correctness of the script has to be verified by the user. The PICKit Serial Analyzer program does not verify the correctness of the script.

A complete listing of the available macro commands is given in Table 7-2. The macro command abbreviation will be displayed in the Transactions Window. The Transactions window keeps a running log of the commands and data sent to and from the target device.

PICkit™ Serial Analyzer User's Guide

FIGURE 7-9: USART SYNCHRONOUS MASTER SCRIPT BUILDER – CREATING A SCRIPT

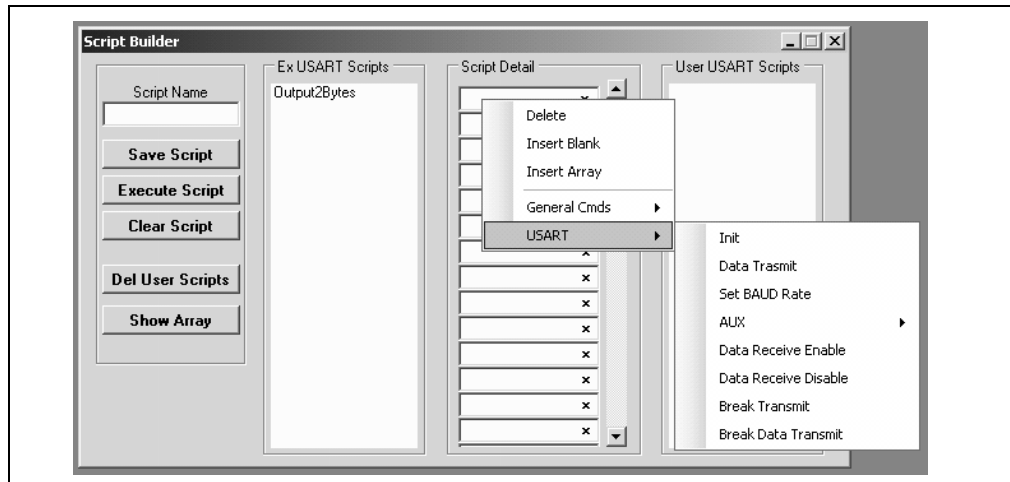

TABLE 7-2: USART SCRIPT MACRO COMMANDS

Macro Command	Command Abbreviation	Description
USDATATX	[TX]	Transmit data. Next byte is the byte count, followed by the data.
USDATARX	[RX]	Receive data. Next byte is the byte count.
USDATARXEN	[ER]	Enable Receive data monitor
USDATARXDS	[DR]	Disable Receive data monitor
USBREAKTX	[BK]	Send Break
USBRKDATTX	[BKD]	Send Break, then data byte. Next byte is the data byte.
USBAUD	[BD]	Set BAUD Rate. Next byte is BAUD (LSB) followed by BAUD (MSB).
US9BITSET	[9S]	Set 9-bit Data mode
US9BITRST	[9R]	Reset 9-bit Data mode (sets 8-bit)
USCLKPOLSET	[CS]	Set CLOCK POLARITY bit
USCLKPOLRST	[CR]	Reset CLOCK POLARITY bit
USINIT	[I_]	Initialize USART controller
USRESET	[RE]	Reset USART controller.
USAUX1RST	[A1RST]	Reset Aux1
USAUX1SET	[A1RST]	Set Aux1
USAUX1OUT	[A1OUT]	Set Aux1 direction to Output
USAUX1IN	[A1IN]	Set Aux1 direction to Input
USAUX1W0	[A1W0]	Aux1 Wait 0
USAUX1W1	[A1W1]	Aux1 Wait 1
USAUX2RST	[A2RST]	Reset Aux2
USAUX2SET	[A2RST]	Set Aux2
USAUX2OUT	[A2OUT]	Set Aux2 direction to Output
USAUX2IN	[A2IN]	Set Aux2 direction to Input
USAUX2W0	[A2W0]	Aux2 Wait 0
USAUX2W1	[A2W1]	Aux2 Wait 1

USART Master Synchronous Communications

7.8 SCRIPT EXECUTE

The Script Execute window is shown in Figure 7-10. Once scripts are created using the Script Builder, they can be assigned to buttons in the Script Execute window. This makes a convenient window to execute multiple scripts either individually or iteratively. Script executing will be logged in the Transactions window.

FIGURE 7-10: USART ASYNCHRONOUS SCRIPT EXECUTE

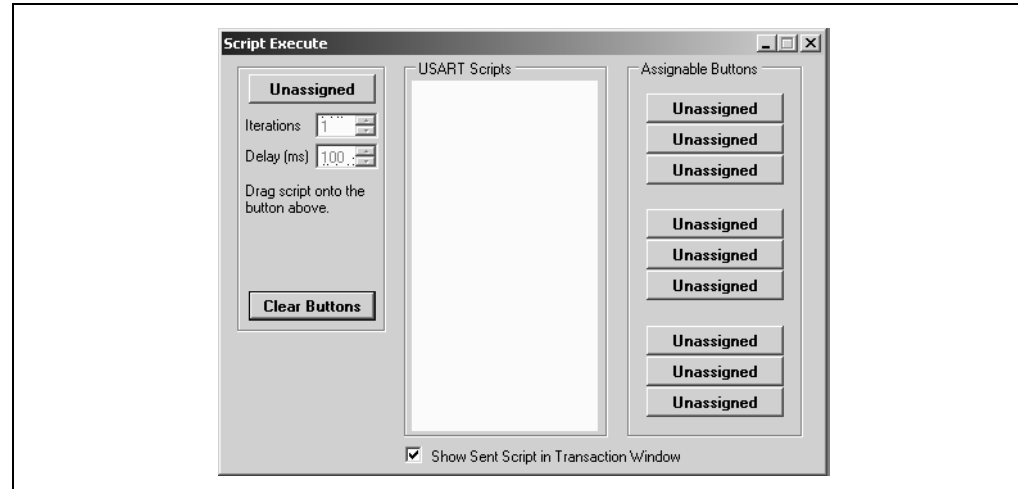

7.8.1 Assignable Buttons

User created scripts will be displayed in the central USART Scripts column. To assign a script to a button, click on the script name and drag it to the desired Assignable Buttons in the right column. The script will be executed once each time the button is clicked.

The Assignable Buttons can be cleared by clicking on the **Clear Buttons** button.

7.8.2 Iteration

Scripts can be executed a user defined number of times at a specified interval of time. Figure 7-11 shows an example. A script named TX_Data has been assigned to the **Iteration** button in the left column. The number of iterations is entered in the Iterations box and the delay in millisecond in the Delay box. A summary of the iterations is displayed in the left column. The macro is executed when the **Iteration** button is clicked.

FIGURE 7-11: USART ASYNCHRONOUS SCRIPT EXECUTE – EXAMPLE

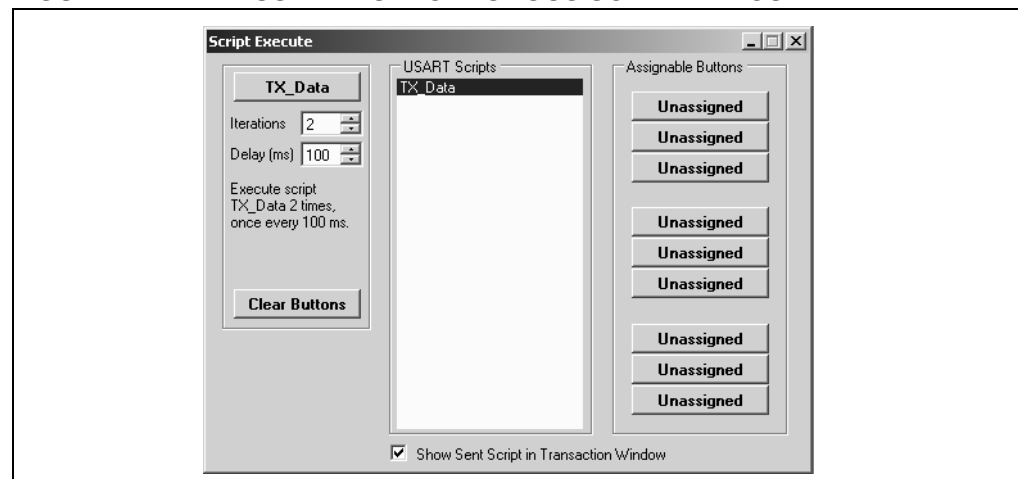

PICkit™ Serial Analyzer User's Guide

NOTES:

Chapter 8. User Defined Templates

8.1 INTRODUCTION

User Defined Templates extend User Scripts by interpreting the data read from the target device and displaying it in a human readable form. The conversion formula is:

EQUATION 8-1: CONVERSION FORMULA

$$\text{Read Value} * \text{Slope} + \text{Offset} = \text{Display Value}$$

For example, an 8-bit ADC value is read, and we desire a displayed value in voltage, 0 to 5 Volts. The 8-bit ADC value (read value) can be 0 to 256 decimal. The ADC reference voltage is 5 VDC. The slope is the constant value used to convert between the ADC read value and the desired display value. In this example:

EQUATION 8-2: SLOPE EXAMPLE

$$\text{Slope} = \text{ADC Reference Voltage} / \text{8-bit ADC} = 5 / 256 = 0.01953125$$

Using a User Defined Template, the interpretation of the ADC value can be displayed in volts DC.

8.2 HIGHLIGHTS

This chapter discusses:

- Create Templates
- My Templates

8.3 CREATE TEMPLATES

Create a User Define Template by selecting User Define Templates > Create Templates from the menu bar. The Create Template window is displayed as shown in Figure 8-1.

Note: First, a user define script(s) must be created using the Script Builder window for the selected serial communications mode. Refer to the respective serial communications chapter under the Script Builder section.

FIGURE 8-1: PARAMETER TEMPLATE

Parameter	Script	Return Data	Start Byte	# of Bytes	Byte Order	Slope	Offset	Units	Format

Create the Parameter Template by filling in the boxes. Each line is a single parameter, a value read converted to value displayed. Each line will be displayed as a button that will execute the individual parameter in the My Templates window.

- Parameter – Enter a parameter name. This name will be displayed next to the button that will execute this parameter in the My Templates window.
- Script – Select a user defined script from the drop down box. This name will be displayed in the button that will execute this parameter in the My Templates window. This script must first be created using the Script Builder for the respective communications mode.
- Return Data – Indicate if data is received (Yes) or not (No)
- Start Byte – Select which byte (of a possible series of bytes) that will be used for the display
- # of Bytes – The number of bytes read
- Byte Order – Select Not Applicable (NA), Least Significant to Most Significant or Most Significant to Least Significant
- Slope – Conversion value (read value * slope + offset = displayed value)
- Offset – Offset of read value (read value * slope + offset = displayed value)
- Units – Units of measure
- Format – Binary, Decimal, Hexadecimal, or BCD (Binary Coded Decimal)
- Signed/Unsigned – Select between Signed or Unsigned read value
- # of Dec. pts – Select number of decimal points in the displayed value

Once the parameter(s) are entered, they can be saved as a User Defined Parameter file (*.udp).

- Open File – Open an existing User Defined Parameter file (*.udp)
- Save/Replace – Save a User Defined Parameter file (*.udp)
- Reset Array – Resets (clears) all parameter boxes

8.4 MY TEMPLATES

When the User Defined Parameter file has been saved, it will be displayed under the *User Defined Templates > My Templates* on the menu bar, as shown in Figure 8-2.

Note: The User Defined Parameter file (*.udp) must be stored in the same directory as the PICKit Serial Analyzer executable (by default C:\Program Files\Microchip\PICKit Serial Analyzer). Otherwise it will not be displayed under the My Templates menu selection.

FIGURE 8-2: SELECTING MY TEMPLATES

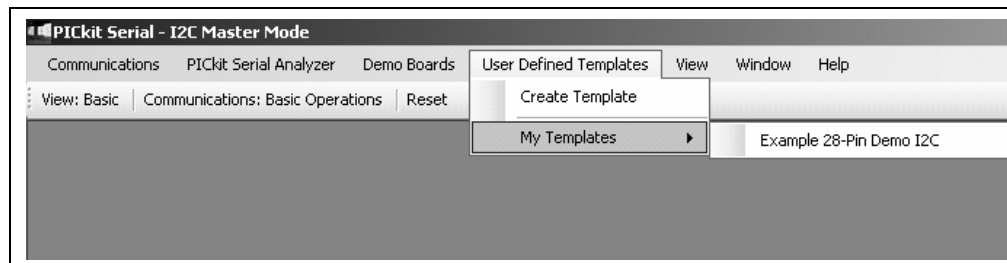

Selecting the User Defined template from the menu bar displays My Template window as shown in Figure 8-3.

FIGURE 8-3: MY TEMPLATES – EXAMPLE

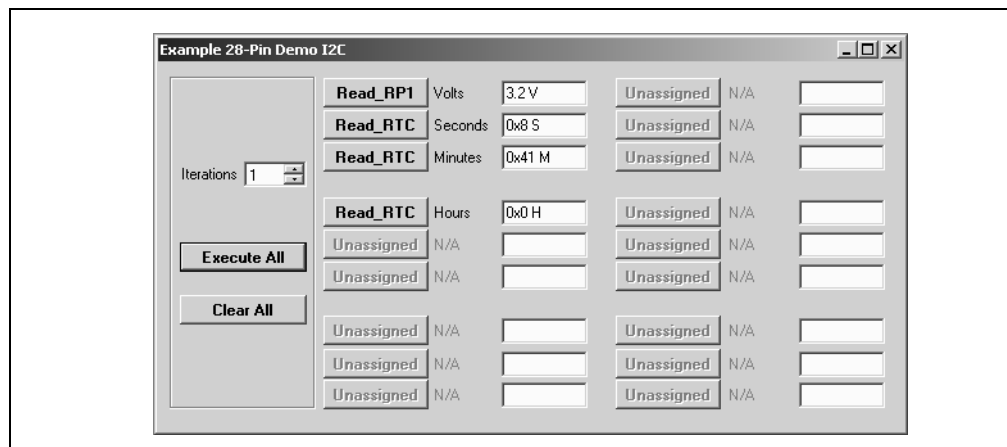

The My Templates window displays the name of the *.udp file in the title bar. For each line entered in the Create Templates window, the Script is displayed in a button, and the Parameter is displayed to the right of the button.

Clicking on an individual button will execute the individual Script/Parameter. The converted value will be displayed in the box to the right of the button. The executed script will be logged in the Transactions window.

Clicking on the **Execute All** button will execute each of the individual buttons in order from top to bottom. The executed scripts will be logged in the Transactions window.

Clicking on the **Clear All** button will clear the values in the boxes.

PICkit™ Serial Analyzer User's Guide

NOTES:

Chapter 9. PICKit™ Serial Analyzer Firmware

9.1 INTRODUCTION

This chapter explains the internal operations of the PICKit™ Serial Analyzer firmware. The source code is available on the PICKit Serial Analyzer CD-ROM at D:\PICKit Serial Analyzer\Firmware.

9.2 HIGHLIGHTS

This chapter discusses:

- EXEC
- COMM
- I²C™ Communications
- SPI Communications
- USART Communications

9.3 OVERVIEW

Internally, the PICKit™ Serial Analyzer operates two firmware state controllers running in parallel – EXEC (executive) and COMM (communication). The EXEC controller is responsible for overall PICKit™ Serial Analyzer configuration, moving data to/from the host (via USB) and moving data to/from the COMM controller (via RAM buffers). The COMM controller supervises serial communication with the target device. This includes both configuring the necessary communication hardware and executing a sequential 'script' defining a serial 'transaction'.

FIGURE 9-1: ARCHITECTURE

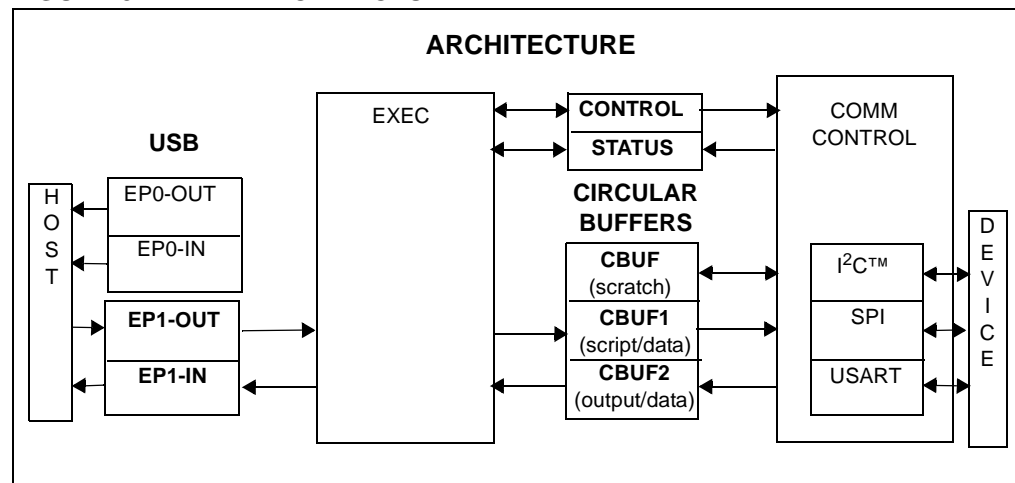

Data streams associated with PICKit™ Serial Analyzer are formatted with markers called "TAG" bytes. A TAG may be stand-alone or accompanied by data. As seen in Table 9-1, the data stream for each state controller has a set of associated TAG bytes defined in detail later in the document.

PICKit™ Serial Analyzer User's Guide

EXEC manages the interface with the host. The data stream sent to PICKit™ Serial Analyzer from the host is encoded with ECMD TAGs and the data stream returned to the host from PICKit™ Serial Analyzer uses EDATA TAGs. Likewise, the COMM controller utilizes another set of predefined TAG(s) - CCMD TAGs (outgoing scripts) and CDATA TAGs (returning data). EXEC has no knowledge of COMM TAG(s) but simply transports data blindly between the host and COMM using EXEC TAG(s). RAM buffers are used as conduits to exchange data with COMM. Data destined for COMM is queued in RAM buffer 1 (CBUF1). Data returning from COMM is funneled through RAM buffer 2 (CBUF2).

The PICKit™ Serial Analyzer is designed to facilitate continuous 'spooling' of data to/from the external serial device. Separate 255-byte circular buffers are maintained for both outgoing data (scripts/data) and returning data. The USB interface is not permitted to be a bottleneck in the PICKit™ Serial Analyzer operation. EXEC processes each USB packet immediately. If data is destined for a RAM buffer, the host is responsible to insure adequate room is available in the buffer before the data is sent to avoid a fatal 'overrun' error. Returning data is queued in the appropriate circular buffer until retrieved by EXEC, tagged and sent to the host. It is possible to overrun the return buffer under some circumstances but should be rare. EXEC can interleave EXEC data with COMM data as necessary.

The PICKit™ Serial Analyzer maintains fixed-length blocks of data for CONTROL and STATUS. The CONTROL_BLOCK provides 'static' configuration information. The STATUS_BLOCK is a snapshot of the PICKit™ Serial Analyzer operation. Each block is divided into three sections corresponding to EXEC, COMM (common to all protocols) and COMM (specific to the active serial protocol).

TABLE 9-1: TAG BYTE TYPES

TAG types	Definition
ECMD	EXEC command TAG(s) – interpreted by EXEC
EDATA	EXEC data TAG(s) – generated by EXEC
CCMD	COMM command TAG(s) – interpreted by COMM
CDATA	COMM data TAG(s) – generated by COMM

The other major blocks are the control memory block and the status memory block. The control block is used to configure the PICKit™ Serial Analyzer. The control block is divided into the following three sections:

- EXEC module configuration
- Generic COMM module configuration
- Protocol specific communication configuration

This third section will change depending on the protocol. The Status block keeps the status of various flags and is similarly divided into three sections.

TABLE 9-2: CONTROL BLOCK

TAG Bytes	Definition
0-7	EXEC section
8-15	Generic COMM section
16-23	Protocol specific communication section

TABLE 9-3: STATUS BLOCK

TAG Bytes	Definition
0-3	EXEC section
4-11	Generic COMM section
12-19	Protocol specific communication section

9.4 EXEC

The EXEC module will directly decode the data stream from the host. The list of different commands is shown in Table 9-4. Every data stream from the software to the PICKit™ Serial Analyzer begins with one of the following EXEC command TAG bytes.

TABLE 9-4: EXEC COMMAND (ECMD) TAG BYTES

TAG/ECMD	LEN	Name	Description
0x00	1	END OF DATA	Marks the end of valid data
			0 TAG
0x01	1	COMMAND	Executive command
			0 TAG
			1 Command byte (see Table 9-5)
0x02	25	CONTROL_BLOCK_WRITE	Write control block to PIC® MCU
			0 TAG
			1:24 Control block
0x03	N+2	CBUF1_WRITE	Write data to circular buffer 1
			0 TAG
			1 Byte count (N)
			2 : N+1 Data
0x04	N+2	CBUF2_WRITE	Write data to circular buffer 2
			0 TAG
			1 Byte count (N)
			2 : N+1 Data
0x05	N+2	CBUF3_WRITE	Write data to circular buffer 3
			0 TAG
			1 Byte count (N)
			2 : N+1 Data
0x06	2	LED1_CONFIG	Configure LED 1
			0 TAG
			1 Configuration Byte
0x07	2	LED2_CONFIG	Configure LED 2
			0 TAG
			1 Configuration byte

TAG byte 0x01 signifies that the following byte is one of the commands listed in Table 9-5.

PICkit™ Serial Analyzer User's Guide

TABLE 9-5: TAG BYTE 0x01 COMMAND CODES

CMD	Description
0x00	Master Reset: EXEC Reset, COMM Reset (idled)
0x01	COMM initialization: COMM is initialized as defined by CONTROL_BLOCK
0x02	Request EXEC_STATUS_PACKET (Ref. Table 9-6)
0x03	Save CONTROL_BLOCK to EEPROM
0x04	Restore CONTROL_BLOCK from EEPROM
0x05	Flush CBUF2
0x06	COMM Reset: rest buffers, clear status block (COMM hardware is not re-initialized)

TABLE 9-6: EXEC STATUS PACKET

Byte	LEN	Type	Description
0	1	0x88	PACKET ID = 0x01
2	4	0x81	FIRMWARE VERSION
5	29	0x82	CONTROL BLOCK
30	50	0x83	STATUS BLOCK
51	57	0x84	CBUF STATUS

TAG byte 0x02 writes the 24-byte CONTROL_BLOCK (the EXEC portion of the control block appears in Table 9-7).

TABLE 9-7: EXEC CONTROL BLOCK

Byte	Bit	Description
0	7:0	EXEC control bits
	0	
	1	
	2	
	3	
	4	1 = Disable default behavior – LED2
	5	1 = Disable default behavior – LED1
	6	1 = Flush CBUF2 on count [e.g. CBUF2 >= N bytes then flush]
7	1 = Flush CBUF2 on time intervals	
1	7:0	
	0	1 = Enable switch test
	1	n/a
	2	n/a
	3	n/a
	4	n/a
	5	n/a
	6	n/a
7	n/a	
2	7:0	
3	7:0	CBUF2 flush count threshold [e.g., CBUF2 > N bytes then flush]
4	7:0	CBUF2 flush interval [res: 409 μs, min: 409 μs, max: 104 μs] a value of '0' defaults to '1', (i.e., the minimum)
5	7:0	
6	7:0	
7	7:0	

TAG bytes 0x03, 0x04 and 0x05 write data bytes to their respective script buffers. In the current architecture, Script Buffer 1 (CBUF1) is used to store communication commands that will be fetched and executed by the COMM block. So, TAG byte 0x03 is used to delineate data that is to be sent to the script buffer including communication protocols to be sent to the unit under test. TAG bytes 0x04 and 0x05 are typically not used. TAG bytes 0x06 and 0x07 configure the LEDs as follows:

TABLE 9-8: LED CONFIGURATION

Description	Mode M = CFG[7:6]	State S = CFG[5]	Time T = CFG[4:0]
Set immediate	00	1 = On, 0 = Off	N/A
Blink once – On or Off	10	1 = On, 0 = Off	T + 1 units
Blink continuous	11	initial state: 1 = On, 0 = Off	T + 1 units
Reserved	01		

Legend: Time "unit" = 50 ms

Note: Set LED to blink continuously, on/off time = 100 ms.
CFG = 0xC1 (M = b'11', S = 0, T = 1)

EXEC data TAG bytes identify data streams sent from the EXEC block back to the host software.

TABLE 9-9: EXEC TAG (EDATA) BYTES

TAG/EDATA	LEN	Name	Description
0x80	1	END OF DATA	Marks the end of valid data
			0 TAG
0x81	1	FIRMWARE_VERSION	Firmware version
			0 TAG
			1 Data: 20-byte STATUS_BLOCK
0x82	25	CONTROL_BLOCK_DATA	Control block contents
			0 TAG
			1:24 Data: CONTROL_BLOCK
0x83	21	STATUS_BLOCK_DATA	Status block contents
			0 TAG
			1:20 Data: minor version
0x84	7	CBUF_STATUS	Status block contents
			0 TAG
			1 Data: CBUF1: # bytes used
			2 Data: CBUF1: # bytes unused
			3 Data: CBUF2: # bytes used
			4 Data: CBUF2: # bytes unused
			5 Data: CBUF3: # bytes used
6 Data: CBUF3: # bytes unused			
0x85	N+2	CBUF1_DATA	Data from CBUF1
			0 TAG
			1 Byte count
0x86	N+2	CBUF2_DATA	Data from CBUF2
			0 TAG
			1 Byte count
			2 : N+1 Data: from CBUF2

PICkit™ Serial Analyzer User's Guide

TABLE 9-9: EXEC TAG (EDATA) BYTES (CONTINUED)

TAG/EDATA	LEN	Name	Description	
0x87	N+2	CBUF3_DATA	Data from CBUF3	
			0	TAG
			1	Configuration byte
			2 : N+1	Data: from CBUF3
0x88	2	PACKET_ID	Packet number	
			0	TAG
			1	Data: arbitrary packet ID#

TAG byte 0x80 means the transaction is over. TAG byte 0x81 signifies that the following data is the firmware version. 0x82 signifies that the data following is the control block (CONTROL_BLOCK). 0x83 signifies that the data following data is the status block (STATUS_BLOCK). The EXEC portion of STATUS_BLOCK is shown in Table 9-10.

TABLE 9-10: EXEC STATUS BLOCK

Byte	Bit	Description
EXEC		
0	7:0	EXEC status
	0	
	1	CBUF1 overflow
	2	CBUF2 overflow
	3	CBUF3 overflow
	4	Data error (e.g. illegal TAG, missing TAG-dependent data, etc.)
	5	Restore control block failed – defaults used
	6	
7	Composite error	
1	7:0	
2	7:0	
3	7:0	

TAG byte 0x84 is the script buffer status which shows availability of memory in each buffer. TAG bytes 0x85, 0x86 and 0x87 identify data streams coming from RAM buffers CBUF1, CBUF2 and CBUF3, respectively. RAM buffer 2 (CBUF2) is used in this architecture to queue the data stream from the COMM module to be sent to the host software, thus TAG byte 0x86 identifies this stream.

TAG bytes 0x85 and 0x87 are typically unused.

9.5 COMM

The COMM module will decode TAG bytes from the data stream in the script buffer. The TAG bytes may represent commands to internally configure the PICkit™ Serial Analyzer and report status, or the TAG bytes may be protocol specific identification that needs to be translated into the device under test's protocol and communicated to the device. The COMM module performs both of these functions. This section will describe the COMM TAGs common to all supported serial protocols. Table 9-11 describes the TAGs (CCMD) used in the data stream to the COMM controller. Table 9-12 describes TAGs (CDATA) used in the data stream from the COMM controller

TABLE 9-11: COMM SCRIPT COMMAND TAG BYTES

TAG/CCMD	LEN	Name	Description
0x00 – 0x0F	16	RESERVED	Reserved
0x10	3	Wait-1	Wait for time interval
			0 TAG
			1 Time (LSB)
			2 Time (MSB) [res: 409.6 ms, max: 26.843 sec]
0x12	2	LED1	Configure LED1
			0 TAG
			1 LED Configuration byte
0x13	2	LED2	Configure LED2
			0 TAG
			1 LED Configuration byte
0x15	3	TIMEOUT_AB0_SET	Set time-out AB0
			0 TAG
			1 Time-out value (LSB)
			2 Time-out value (MSB) [res: 409.5 ms, max: 26.843 sec]
0x16	1	TIMEOUT_AB0_KILL	Kill/disable time-out AB0
			0 TAG
0x17	3	TIMEOUT_AB1_SET	Set time-out AB1
			0 TAG
			1 Time-out value (LSB)
			2 Time-out value (MSB) [res: 409.6 ms, max: 26.843 sec]
0x18	1	TIMEOUT_AB1_KILL	Kill/disable timeout AB1
			0 TAG
0x19	1	MACRO_CLEAR	Start macro definition
			0 TAG
0x1A	N+2	MACRO_DATA_ADD	Add bytes to macro
			0 TAG
			1 Byte count (N)
			2 Data
			N+1 Data
0x1B	3	MACRO_RUN	Run macro
			0 TAG
			1 Loop count [0 = indefinitely]
			2 Loop count [0 = indefinitely]
0x1C	1	END_OF_SCRIPT	Mark end of script
			0 TAG
0x1D	1	MACRO_DATA_START	Mark start of "macro" data block
			0 TAG
0x1E	1	MACRO_DATA_END	Mark end of "macro" data block
			0 TAG
0x1F	2	MARKER	Script "marker"
			0 TAG
			1 Marker
0x20	1	EVENT_TIMER_RESET	Event timer Reset
			0 TAG

PICkit™ Serial Analyzer User's Guide

TABLE 9-12: COMM SCRIPT DATA TAG BYTES

TAG/CDATA	LEN	Name	Description
0x00 – 0x0F	16	RESERVED	RESERVED
0x10	2	DATA_BYTE	Data byte follows
			0 TAG
			1 data
0x11	N+2	DATA_BYTES	Data bytes follow
			0 TAG
			1 Byte count (N)
			2 Data
			N+1 Data
0x12	2	EVENT_MACRO_LOOP	Macro loop count milestone message
			0 TAG
			1 Loop number
0x13	3	EVENT_TIME	Time marker for previous event
			0 TAG
			1 Time LSB
			2 Time MSB [res: 409 usec, max: 26.8 sec]
0x14	1	EVENT_TIME_ROLLOVER	Event timer rollover
			0 TAG
0x15	3	EVENT_MACRO_DONE	Macro loop complete
			0 TAG
			1 Loop count (LSB)
			2 Loop count (MSB)
0x16	1	EVENT_MACRO_ROLLOVER	Macro loop count rollover (65536) (useful with infinite loop count)
			0 TAG
0x17	1	EVENT_MACRO_ABORT	Macro execution was aborted by bit in command block
			0 TAG
0x18	1	EVENT_TIMEOUT_AB0	Timer AB0 timeout
			0 TAG
0x19	1	EVENT_TIMEOUT_AB1	Timer AB1 timeout
			0 TAG
0x1A	2	EVENT_STATUS_ERR	Status error
			0 TAG
			1 STATUS_BLOCK[04]
0x1B	1	EVENT_END_OF_SCRIPT	“End-of-Script” TAG encountered
			0 TAG
0x1C	2	MARKER	“Marker” tag encountered
			0 TAG
			1 MARKER

TABLE 9-13: COMM SCRIPT CONTROL BLOCK

Byte	Bit	Description
COMM: GENERAL		
8	7:0	COMM mode: 00: IDLE 01: I ² CM 02: SPI-M 04: USART-A 05: USART-SM
9	7:0	COMM control bits
	0	1 = Enable event markers – global
	1	1 = Enable event markers – time stamp
	2	n/a
	3	n/a
	4	1 = Enable PULLUPS
	5	1 = VSRC: On
	6	1 = VSRC: variable
7	1 = Abort macro execution	
10	7:0	Bit flags
	0	1 = Event marker enable: macro loop
	1	1 = Event marker enable: macro loop 65536
	2	1 = Event marker enable: macro loop done
	3	1 = Event marker enable: time-out AB0
	4	1 = Event marker enable: time-out AB1
	5	1 = Event marker enable: status error (STATUS_BLOCK[04] != 0)
	6	1 = (Unassigned)
7	1 = (Unassigned)	
11	7:0	N/A
12	7:0	VSRC 8-bit setting
13	7:0	VSRC Fault Threshold
14	7:0	N/A
15	7:0	N/A

TABLE 9-14: COMM SCRIPT STATUS BLOCK

Byte	Bit	Description
COMM: GENERAL		
4	7:0	COMM status: error
	0	Time-out AB0
	1	Time-out AB1
	2	COMM initialization error
	3	VSRC fault
	4	Data error (e.g., unrecognized TAG, missing data, etc.)
	5	Output buffer overrun (CBUF2)
	6	Output buffer overrun (CBUF3)
5	7:0	COMM status: informational
	0	Controller busy
	1	Executing MACRO
	2	Executing MACRO – infinite loop
	3	Executing WAIT instruction
	4	
	5	
	6	
7	“End-of-Script” TAG encountered	
6	7:0	COMM mode
7	7:0	VSRC Measurement (0-255)
8	7:0	
9	7:0	
10	7:0	
11	7:0	

9.6 I²C COMMUNICATIONS

I²C refers to the Master mode of the I²C protocol. See the I²C specification for protocol details. In this mode, the PICkit™ Serial Analyzer will master the I²C bus only. It will not respond as a slave. The control block of memory dedicated to communication allows for setting of the bit rate and displaying event markers in the software windows.

TABLE 9-15: CONNECTOR PINOUT IN I²C MODE

Pin	Description
1	—
2	+V
3	GND
4	SDA
5	SCL
6	—

TABLE 9-16: I²CM CONTROL BLOCK

Byte	Bit	Description
COMM: I²CM		
16	7:0	Bit flags
	0	1 = event marker enable: Start bit
	1	1 = event marker enable: Stop bit
	2	1 = event marker enable: Restart bit
	3	1 = event marker enable: ack tx
	4	1 = event marker enable: nack tx
	5	1 = event marker enable: ack rx
	6	1 = event marker enable: nack rx
	7	1 = event marker enable: write byte
17	7:0	Bit flags
	0	1 = event marker enable: read byte
	1	1 = event marker enable: transaction error
	2	1 = event marker enable: status error (STATUS_BLOCK[12] != 0)
	3	
	4	
	5	
	6	
7		
18	7:0	
19	7:0	
20	7:0	
21	7:0	
22	7:0	
23	7:0	BIT RATE = (FOSC / (4 * (X + 1))) min: 0, max: 127 49 => 100k bps 127 => 39k bps

TABLE 9-17: I²C STATUS BLOCK

Byte	Bit	Description
COMM: I²C		
12	7:0	Bit flags: error status
	0	WCOL error
	1	SSPOV error
	2	
	3	
	4	
	5	
	6	
	7	Composite error
13	7:0	Bit flags: info status
	0	
	1	
	2	
	3	
	4	
	5	
	6	
	7	
14	7:0	
15	7:0	
16	7:0	
17	7:0	
18	7:0	
19	7:0	BIT RATE CODE currently in use

The I²C TAG/CCMND bytes are used by the host (software) to describe an I²C transaction in 'script' form. The script is sent via USB to the script buffer (CBUF1) and interpreted by the COMM controller to execute the transaction on the I²C bus. The return data stream contains I²C read data as well as 'event marker' TAGs that mark the occurrence of each entity of the I²C transaction (e.g., TAG: 0x81 indicates a "Start" bit).

TABLE 9-18: I²C ‘CMD’ TAG BYTES

TAG/CCMD	LEN	Name	Description
0x80	1	I ² C_CMD_INIT	Initialize master
			0 TAG
0x81	1	I ² C_CMD_START	Issue I ² C™ Start
			0 TAG
0x82	1	I ² C_CMD_STOP	Issue I ² C™ Stop
			0 TAG
0x83	1	I ² C_CMD_RESTART	Issue I ² C™ Restart
			0 TAG
0x84	N+2	I ² C_CMD_WRITE_BYTES	Write bytes
			0 TAG
			1 byte count (N)
			2 data byte
0x85	2	I ² C_CMD_READ_BYTES	Read bytes – ACK all bytes
			0 TAG
			1 byte count (N)
			2 data byte
0x86	1	I ² C_CMD_READ_BLOCK	Read block – ACK all bytes
			0 TAG
0x87	2	I ² C_CMD_BIT_RATE	Set I ² C™ bit rate
			0 TAG
			1 bit rate
0x88	1	I ² C_CMD_RESET	Reset MSSP module
			0 TAG
0x89	2	I ² C_CMD_READ_BYTES_NLB	Read bytes – NACK last byte
			0 TAG
			1 byte count (N)
0x8A	1	I ² C_CMD_READ_BLOCK_NLB	Read block – NACK last byte
			0 TAG

An example of a data stream in the script buffer that would direct the COMM back to communicate in I²C to the unit.

Under test is as follows:

0x81	I ² C_CMD_START
0x84	I ² C_CMD_WRITE_BYTES
0x02	Number of bytes
0xA8	I ² C™ address for writing
0x01	I ² C™ command code
0x83	I ² C_CMD_RESTART
0x84	I ² C_CMD_WRITE_BYTES
0x01	Number of bytes
0xA9	I ² C™ address for reading
0x89	I ² C_CMD_READ_BYTES_NLB
0x01	Number of bytes
0x82	I ² C_CMD_STOP

PICkit™ Serial Analyzer User's Guide

The script (above) is interpreted as follows. TAG 0x81 instructs the COMM module to generate an I²C 'Start' bit on the I²C bus. TAG 0x84 indicates 2 bytes will be transmitted following the start – 0xA8 and 0x01. The first byte is the I²C slave address (with write/read bit Reset) and a data/command byte of 0x01. The COMM module does not place any significance on the value of the data bytes but merely transmits them 'blindly' – as instructed. The next TAG 0x83 instructs the COMM module to issue a Restart bit on the I²C bus. TAG and data bytes - 0x84, 0x01, 0xA9 – will cause 1 byte (0xA9) to be transmitted. Here again, the COMM module does not interpret the data – the I²C slave will interpret 0xA9 as an address with write/read bit set. TAG 0x89 followed by data byte 0x01 instructs the COMM module to attempt to read 1 byte from the slave then issue a NACK on the bus. Finally, an I²C 'Stop' bit is issued according to tag 0x82. The resulting I²C transaction looks like this on the bus:

[START][A8][01][RESTART][A9][data byte received][STOP]

As the script is executed, a data stream will be developed using TAGs/CDATA (described in Table 9-19) and returned to the host software via CBUF2.

TABLE 9-19: I²CM 'DATA' TAG BYTES

TAG/ CDATA	LEN	Name	Description
0x80	1	I ² CM_EVENT_START_TX	Start bit event
			0 CDATA-TAG
0x81	1	I ² CM_EVENT_STOP_TX	Stop bit event
			0 CDATA-TAG
0x82	1	I ² CM_EVENT_RESTART_TX	Restart bit event
			0 CDATA-TAG
0x83	1	I ² CM_EVENT_ACK_TX	ACK bit event
			0 CDATA-TAG
0x84	1	I ² CM_EVENT_NACK_TX	NACK bit event
			0 CDATA-TAG
0x85	1	I ² CM_EVENT_ACK_RX	ACK bit event
			0 CDATA-TAG
0x86	1	I ² CM_EVENT_NACK_RX	NACK bit event
			0 CDATA-TAG
0x87	2	I ² CM_EVENT_BYTE_TX	BYTE transmit
			0 CDATA-TAG
			1 data
0x88	2	I ² CM_EVENT_BYTE_RX	BYTE transmit
			0 CDATA-TAG
			1 data
0x89	2	I ² CM_EVENT_XACT_ERR	transaction error
			0 CDATA-TAG
			1 error byte
0x8A	2	I ² CM_EVENT_STATUS_ERR	status error
			0 CDATA-TAG
			1 error byte

9.7 SPI COMMUNICATIONS

SPI is a 4-wire serial protocol that uses data in, data out, clock and Chip Select pins. It is a very basic protocol using a clock edge to capture data. The CONTROL_BLOCK is used to enable SPI event markers, set the bit rate and configure transaction/protocol options.

TABLE 9-20: CONNECTOR PINOUT IN SPI MODE

Pin	Description
1	$\overline{\text{CS}}$
2	+V
3	GND
4	SDI
5	SCK
6	SDO

TABLE 9-21: SPI CONTROL BLOCK

Byte	Bit	Description
COMM: SPI		
16	7:0	Bit flags
	0	1 = Event marker enable: read byte
	1	1 = Event marker enable: write byte
	2	1 = Event marker enable: status error
	3	1 =
	4	1 =
	5	1 =
	6	1 =
17	7:0	SPI Configuration bits
	0	1 = SMP (sample phase)
	1	1 = CKE (clock edge select)
	2	1 = CKP (clock polarity)
	3	1 = DAOD (disable auto output disable on data input)
	4	1 = SS
	5	1 =
	6	1 = SLAVE
7	1 = MASTER	
18	7:0	
19	7:0	
20	7:0	
21	7:0	
22	7:0	BIT RATE: Pre-scale code
23	7:0	BIT RATE: Scale code

PICkit™ Serial Analyzer User's Guide

TABLE 9-22: BIT RATE CODES

Fosc	Pre-Scale Code	Pre-Scale Value	Scale Code	Scale Value	Total Scale Value	Bit Rate
20 MHz	0x00	8	0x00	1	8	2.500 MHz
20 MHz	0x00	8	0xFF	256	2048	9.766 kHz
20 MHz	0x01	32	0x00	1	32	0.625 MHz
20 MHz	0x01	32	0xFF	256	8192	2.441 kHz
20 MHz	0x02	128	0x00	1	128	0.156 MHz
20 MHz	0x02	128	0xFF	256	32768	0.610 kHz

TABLE 9-23: SPI STATUS BLOCK

Byte	Bit	Description
COMM: SPI		
12	7:0	Bit flags: error status
	0	WCOL error
	1	SSPOV error
	2	
	3	
	4	
	5	
	6	
13	7:0	SPI Configuration bits
	0	1 = SMP (sample phase)
	1	1 = CKE (clock edge select)
	2	1 = CKP (clock polarity)
	3	1 = AOD (auto output disable on data input)
	4	1 = SS
	5	1 =
	6	1 = SLAVE
7	1 = MASTER	
14	7:0	
15	7:0	
16	7:0	
17	7:0	
18	7:0	BIT RATE: Pre-scale (ref: section: x.x.x)
19	7:0	BIT RATE: Scaling (ref: section: x.x.x)

TABLE 9-24: SPI 'CMD' TAG BYTES

TAG/CCMD	LEN	Name	Description
0x80	1	SPI_MODE_IDLE	Set to IDLE
			0 TAG
0x81	2	SPI_INIT_MODE	Initialize SPS controller as per DATA
			0 TAG
			1 Configuration bits (ref section x.x.x)
0x83	3	SPI_BITRATE	Set bit rate
			0 TAG
			1 scaler
			2 pre-scaler (ref section x.x.x)
0x84	2	SPI_DATAIO_IN	Input data
			0 TAG
			1 byte count (N)
0x85	N+2	SPI_DATAIO_OUT	Output data
			0 TAG
			1 byte count (N)
			2 data
			N+1 data
0x86	N+2	SPI_DATAIO_INOUT	Output data
			0 TAG
			1 byte count (N)
			2 data
			N+1 data
0x87	1	SPI_SDO_IN	Set SDO pin to INPUT (tri-state)
			0 TAG
0x88	1	SPI_SDO_OUT	Set SDO pin to OUTPUT
			0 TAG
0x89	1	SPI_RESET	Reset SPI controller to IDLE
			0 TAG
0x8A	1	SPI_INIT	Initialize SPI controller per CONTROL BLOCK
			0 TAG
0x8B	1	SPI_CS_ON	Assert CS* (low true)
			0 TAG
0x8C	1	SPI_CS_OFF	De-assert CS*
			0 TAG

TABLE 9-25: SPI 'DATA' TAG BYTES

TAG/CDATA	LEN	Name	Description
0x80	2	SPI_EVENT_BYTE_TX	BYTE transmit
			0 TAG
			1 data
0x81	2	SPI_EVENT_BYTE_RX	BYTE transmit
			0 TAG
			1 data
0x82	2	SPI_EVENT_STATUS_ERR	Status error
			0 TAG
			1 error byte

9.8 USART COMMUNICATIONS

Universal Synchronous Asynchronous Receive Transmit (USART) protocol is a standard 2-wire serial communication. In Asynchronous mode, there is a transmit line and a receive line. In Synchronous mode, the transmit line becomes the clock line and the receive line becomes the bidirectional data line. In Asynchronous mode, 8 bits are framed by a Start and Stop bit. A ninth bit can be included to use as a parity bit.

To configure the protocol, set the clock polarity to rising edge or falling edge if using Synchronous mode. Enable or disable 9-bit words and enable or disable the asynchronous receiving ability of the PICkit™ Serial Analyzer. Select the baud rate according to the BRG table.

TABLE 9-26: CONNECTOR PINOUT IN USART ASYNCHRONOUS MODE

Pin	Description
1	TX
2	+V
3	GND
4	—
5	—
6	RX

TABLE 9-27: CONNECTOR PINOUT IN USART SYNCHRONOUS MODE

Pin	Description
1	Clock
2	+V
3	GND
4	—
5	—
6	Data

TABLE 9-28: USART CONTROL BLOCK

Byte	Bit	Description
COMM: USART		
16	7:0	
17	7:0	
	0	Clock polarity (default) 1 = high-low at beginning of bit cell, 0 = low-high
	1	1 = 9-bit word length (default)
	2	1 = Async receive enable
	3	1 =
	4	1 =
	5	1 =
	6	1 =
18	7:0	
	0	1 = Event marker enable: read byte
	1	1 = Event marker enable: write byte
	2	1 = Event marker enable: status error
	3	1 = Event marker enable: break tx
	4	1 =
	5	1 =
	6	1 =
19	7:0	
20	7:0	
21	7:0	
22	7:0	BRG (BAUD) default (LSB)
23	7:0	BRG (BAUD) default (MSB)

TABLE 9-29: BRG BAUD RATE TABLE

BAUD = Fosc/(4*(BRG + 1))			
BAUD	BRG	ACTUAL	ERR
300	16666	300.0	0.00%
1200	4166	1199.9	-0.01%
4800	1041	4798.5	-0.03%
9600	520	9596.9	-0.03%
19200	259	19230.8	0.16%
28800	173	28735.6	-0.22%
57600	86	57471.3	-0.22%
115200	42	116279.1	0.94%

PICkit™ Serial Analyzer User's Guide

TABLE 9-30: USART STATUS BLOCK

Byte	Bit	Description
COMM: USART		
12	7:0	Bit flags: error status
	0	FERR – framing error
	1	OERR – overrun error
	2	INIT error (bad “mode”)
	3	
	4	
	5	
	6	
	7	Composite error
13	7:0	
14	7:0	
	0	Clock polarity (default) 1 = high-low at beginning of bit cell, 0 = low-high
	1	1 = 9-bit word length (default)
	2	1 = Async receive enable
	3	1 =
	4	1 =
	5	1 =
	6	1 =
	7	1 =
7	1 =	
15	7:0	
16	7:0	
17	7:0	
18	7:0	BRG (BAUD) default (LSB)
19	7:0	BRG (BAUD) default (MSB)

TABLE 9-31: USART 'CMD' TAG BYTES

TAG/ CCMD	LEN	Name	Description
0x80	1	USART_INIT	Initialize USART controller
			0 TAG
0x81	1	USART_RESET	Reset USART controller
			0 TAG
0x82	N+2	USART_DATA_XMT	Transmit data
			0 TAG
			1 Byte count (N)
			2 Data
			N+1 Data
0x83	2	USART_DATA_ARCV	Receive data
			0 TAG
			1 Byte count (N)
0x84	1	USART_DATA_SRCV_ENABLE	Enable receive data monitor
			0 TAG
0x85	1	USART_DATA_SRCV_DISABLE	Disable receive data monitor
			0 TAG
0x86	1	USART_BREAK_XMT	send BREAK
			0 TAG
0x87	2	USART_BREAK_DATA_XMT	send BREAK then DATA byte
			0 TAG
			1 DATA byte (TYP: 0x55)
0x88	3	USART_BAUD	set BAUD rate
			0 TAG
			1 BAUD value (LSB)
			2 BAUD value (MSB) (Reference Table 9-29)
0x89	1	USART_SCKP_SET	set "CLOCK POLARITY" bit
			0 TAG
0x8A	1	USART_SCKP_RST	reset "CLOCK POLARITY" bit
			0 TAG
0x8B	1	USART_9BIT_SET	set 9-bit Data mode
			0 TAG
0x8C	1	USART_9BIT_RST	reset 9-bit Data mode (sets 8-bit)
			0 TAG

TABLE 9-32: USART 'DATA' TAG BYTES

TAG/ CDATA	LEN	Name	Description
0x80	2	USART_EVENT_BYTE_TX	BYTE transmit
			0 TAG
			1 data
0x81	2	USART_EVENT_BYTE_RX	BYTE received
			0 TAG
			1 data
0x82	2	USART_EVENT_STATUS_ERR	Status error
			0 TAG
			1 error byte
0x83	1	USART_EVENT_BREAK_TX	BREAK transmitted
			0 TAG

Chapter 10. PICKit™ Serial Analyzer DLL

10.1 INTRODUCTION

Custom software programs can be created by accessing the Dynamically Linked Library (DLL), PICKitS.dll, with the software language of your choice. All of the functionality to create tag byte scripts that will be converted to protocol scripts is built into the DLL and is very easy to use. Any programming language that can access functions from a DLL can be used. All that is needed is a list of the built-in functions and the arguments they require.

The name of the DLL is PickitS.dll. The functions used to create custom GUI apps are in a subsection of the dll called "basic". The function calls are listed in the Summary of Functions section below.

10.2 HIGHLIGHTS

This chapter discusses:

- Summary of Functions
- Programming Example

10.3 SUMMARY OF FUNCTIONS

PickitS.Basic.*function(argument1, argument2,...)*

A table of the functions and their definitions is below:

TABLE 10-1: FUNCTIONS

PICKitS.Basic.Cleanup
PICKitS.Basic.Configure_PICKitSerial
PICKitS.Basic.There_Is_A_Status_Error
PICKitS.Basic.Configure_PICKitSerial_For_I2C
PICKitS.Basic.Get_Status_Packet
PICKitS.Basic.Initialize_PICKitSerial
PICKitS.Basic.Reset_Control_Block
PICKitS.Basic.Retrieve_USART_Data
PICKitS.Basic.Send_I2CRead_Cmd
PICKitS.Basic.Send_I2CWrite_Cmd
PICKitS.Basic.Send_SPI_Receive_Cmd
PICKitS.Basic.Send_SPI_Send_Cmd
PICKitS.Basic.Send_USART_Cmd

10.3.1 PICKitS.Basic.Cleanup()

Returns: Void
Inputs: None
Description: Shuts down communication threads and closes file handles. Must be performed prior to closing host application.

10.3.2 PICkitS.Basic.Configure_PICkitSerial(int p_mode, bool p_reset)

Returns: True if successful, False if not

Inputs: p_mode: the communications mode where:

- 0 = IDLE
- 1 = I²CM
- 2 = SPI-M
- 3 = SPI-S
- 4 = USART-A
- 5 = USART-SM
- 6 = USART-SS
- 7 = I²CS
- 8 = I²CBBM
- 9 = I²CSBBM

p_reset: whether or not to perform a Reset of the PICkit™ Serial after changing modes

<p>Note: Unless performing certain test routines on the PICkit™ Serial Analyzer, p_reset should always be TRUE</p>

10.3.3 PICkitS.Basic.There_Is_A_Status_Error(ref uint p_error)

Returns: True if any status error bit is set, False if not

Inputs: Reference to an unsigned int (32-bit)

Description: Looks at the latest Status_Packet data stored in the class library and copies the Exec status into byte 0, Comm status into byte 1, and comm-mode specific status (I²C, SPI, etc.) into byte 2. Byte 3 is left blank for future use. If any bit in any of the bytes is set, this indicates an error and a True value is returned.

10.3.4 PICkitS.Basic.Configure_PICkitSerial_For_I2C()

Returns: True if successful, False if not

Inputs: None

Description: Configures PICkit™ Serial control block for I2C_M (I²C Master) communication

10.3.5 PICkitS.Basic.Get_Status_Packet(ref byte[] p_status_packet)

Returns: True if the status packet is successfully updated, False if there is an error updating the status packet.

Inputs: p_status_packet - Reference to an array of bytes. The array must be at least 65 bytes long to hold the status packet data.

Description: Issues a command to update the Status Packet stored in the class library and copy it to p_status_packet. Call this function to get detailed information regarding the status block and control block of the PICkit™ Serial. Refer to Chapter 9 to see the format of the Status Packet.

10.3.6 PICkitS.Basic.Initialize_PICkitSerial()

Returns: True if successful, False if not

Inputs: None

Description: Attempts to establish communication with PICkit™ Serial Analyzer and initialize communication threads used by class library. If multiple PICkit™ Serial Analyzers are attached to host PC, function will only initialize first one it finds.

10.3.7 PICkitS.Basic.Reset_Control_Block()

Returns: True if successful, False if not
Inputs: None
Description: Attempts to clear status flags set during a read or write error by issuing cold then warm Resets while preserving control block contents. Issue this function call after a read or write failure.

10.3.8 PICkitS.Basic.Retrieve_USART_Data(uint p_byte_count, ref byte[] p_data_array)

Returns: Data from USART bus
Inputs: p_byte_count: number of bytes to read
p_data_array: Reference to an array of bytes
Description: reads a number of bytes from the USART bus and stores them in p_data_array array. p_data_array must be at least p_byte_count in size.

10.3.9 PICkitS.Basic.Send_I2CRead_Cmd(byte p_slave_addr, byte p_start_data_addr, byte p_num_bytes_to_read, ref byte[] p_data_array, ref string p_script_view)

Returns: True if successful, False if not
Inputs: byte p_slave_addr - I²C slave address of UUT
byte p_start_data_addr - I²C command code or address of memory to begin reading
byte p_num_bytes_to_read - number of bytes to be returned
byte[] p_data_array - reference to byte array that will store retrieved data
-must be at least as large as p_num_bytes_to_read
string p_script_view - reference to a string to which will be copied a formatted view of the command
Description: Attempts to perform I²C read command using above parameters. If successful, p_num_bytes_to_read is copied into p_data_array. It is the user's responsibility to ensure p_data_array has enough room. Regardless of success or failure, the PICkit™ status packet is updated after the read attempt and stored for retrieval by the function Get_Status_Packet.

Note: This function issues the I²C Read Bytes Nack Last Byte command, not the I²C Read Bytes command.

10.3.10 PICkitS.Basic.Send_I2CWrite_Cmd(byte p_slave_addr, byte p_start_data_addr, byte p_num_bytes_to_write, ref byte[] p_data_array, ref string p_script_view)

Returns: True if successful, False if not
Inputs: byte p_slave_addr - I²C slave address of UUT
byte p_start_data_addr - I²C command code or address of memory to begin writing to
byte p_num_bytes_to_write - number of bytes to be written
byte[] p_data_array - reference to byte array that holds data to be written
string p_script_view - reference to a string to which will be copied a formatted view of the command

Description: Attempts to perform I²C Write command using above parameters. If successful, p_num_bytes_to_write bytes are written to the UUT beginning at p_start_data_addr. Regardless of success or failure, the PICkit™ status packet is updated after the write attempt and stored for retrieval by the function Get_Status_Packet.

10.3.11 PICkitS.Basic.Send_SPI_Receive_Cmd(byte p_num_bytes_to_read, ref byte[] p_data_array, bool p_first_cmd, bool p_last_cmd, ref string p_script_view)

Returns: True if successful, False if not

Inputs: byte p_num_bytes_to_read - number of bytes to read
byte[] p_data_array - reference to byte array that will store retrieved data

bool p_first_cmd - flag for first command, set to true if this is the first (or only) command in a group of commands. This will prepend the assert Chip Select byte (0x8B) to the command

bool p_last_cmd - flag for last command, set to true if this is the last (or only) command in a group of commands. This will append the de-assert Chip Select byte (0x8C) to the command

string p_script_view - reference to a string to which will be copied a formatted view of the command

Description: Attempts to perform SPI read command using above parameters. If successful, p_num_bytes_to_read is copied into p_data_array. It is the users responsibility to ensure p_data_array has enough room. Regardless of success or failure, the PICkit™ status packet is updated after the read attempt and stored for retrieval by the function Get_Status_Packet.

10.3.12 PICkitS.Basic.Send_SPI_Send_Cmd(byte p_byte_count, ref byte[] p_data, bool p_first_cmd, bool p_last_cmd, ref string p_script_view)

Returns: True if successful, False if not

Inputs: byte p_byte_count - number of bytes to write

byte[] p_data_array - reference to byte array that holds data to be written

bool p_first_cmd - flag for first command, set to true if this is the first (or only) command in a group of commands. This will prepend the assert Chip Select byte (0x8B) to the command

bool p_last_cmd - flag for last command, set to true if this is the last (or only) command in a group of commands. This will append the de-assert Chip Select byte (0x8C) to the command

string p_script_view - reference to a string to which will be copied a formatted view of the command

Description: Attempts to perform SPI write command using above parameters. If successful, p_num_bytes_to_write bytes are written to the UUT. Regardless of success or failure, the PICkit™ status packet is updated after the write attempt and stored for retrieval by the function Get_Status_Packet.

10.3.13 PICkitS.Basic.Send_USART_Cmd(byte p_byte_count, ref byte[] p_data, ref string p_script_view)

Returns: True if successful, False if not

Inputs: byte p_bytes_count - number of bytes to send

byte[] p_data- data to send to USART bus

string p_script_view - reference to a string to which will be copied a formatted view of the command

Description: sends data from p_data array to USART bus.

10.4 PROGRAMMING EXAMPLE

The following is an example of creating a Visual Basic® .NET program using the dll to read an I²C device.

1. In Solution Explorer, if References is not shown, press the **Show All Files** button.
2. Right click on references in solution explorer, browse to the PICkitS.dll and add it.
3. Double click the form to create Sub Form1_Load.

4. Add following to form1_load:

```
PICkitS.Basic.Initialize_PICkitSerial()  
PICkitS.Basic.Configure_PICkitSerial_For_I2C()
```

5. On the Form1.vb [Design] view, click on the **Events** button in the Properties Window.

6. Double click the **FormClosed Event** to create Sub Form1_FormClosed

7. Add the following line in Form1_FormClosed:

```
PICkitS.Basic.Cleanup()
```

8. On the form, add three text boxes and three labels as shown in the Figure 10-1 below.

FIGURE 10-1: TEXT BOXES AND LABELS



9. Name the text boxes as follows:

```
TextBox_Slave_Addr  
TextBox_Word_Addr  
TextBox_Result
```

10. Add a button, change the text to "Read One Byte" and double click it creating the sub Button1_Click.

11. Add the following code to Button1_Click:

```
Dim Return_String AsString = vbNullString  
Dim Return_Data(1) AsByte  
Dim Slave_Addr AsByte = Convert.ToByte(TextBox_Slave_Addr.Text)  
Dim Word_addr AsByte = Convert.ToByte(TextBox_Word_Addr.Text)
```

PICkit™ Serial Analyzer User's Guide

```
PICkitS.Basic.Send_I2CRead_Cmd(Slave_Addr, Word_addr, 1,  
                               Return_Data, Return_String)
```

```
TextBox_Result.Text = Return_Data(0).ToString()
```

12. Build the project by pressing **F6**.
13. Fix any typos and rebuild if necessary.
14. Press the **Run** button to execute the program.
15. Enter the slave address and the word address to read one byte of data.

Chapter 11. Troubleshooting

11.1 INTRODUCTION

This chapter describes questions and answers to common problems associated with using the PICKit™ Serial Analyzer and how to resolve them.

11.2 FREQUENTLY ASKED QUESTIONS

PICKit™ Serial Analyzer could not be found

Question

I am receiving the error message, "PICKit™ Serial Analyzer could not be found" in the Transactions window, but the PICKit™ Serial Analyzer is plugged in. What is wrong?

Answer

Open the Windows® operating system Device Manger by clicking on *Control Panel > System*, selecting the Hardware tab and clicking on **Device Manger** button. Check if there is an error displayed under Human Interface Devices as shown in Figure 11-1.

If an error is displayed, try unplugging and the re-plugging the USB cable until the error goes away (this may take 3 or 4 tries).

If the error persists, try another USB port or hub. Try plugging the PICKit™ Serial Analyzer into another computer to verify that the USB port is working.

FIGURE 11-1: WINDOWS® DEVICE MANGER

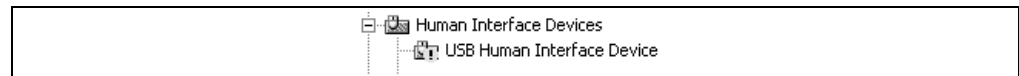

Current Limit Exceeded

Question

I received the error message "USB Hub Current Limit Exceeded" from the Windows® operating system. What is wrong?

Answer

The USB port current limit is set to 100 mA. If the target device plus PICKit™ Serial Analyzer exceeds this current limit, the USB port will shut down. Check for shorts. The target device can be externally powered if more power is needed.

Microsoft® Windows® 98 SE

Question

After plugging the PICKit™ Serial Analyzer into the USB port, Windows® 98 SE asks for a driver. Where is the driver?

Answer

PICKit™ Serial Analyzer uses the Human Interface Device (HID) driver included with the Windows® Operating System. When Windows® 98 SE prompts for a driver, select "Search for the best driver for your device." Then select the check box next to "Microsoft Windows Update" and click Next. Windows will automatically install the appropriate driver. Do not use Microchip's MPLAB® ICD 2 USB driver.

Microsoft® Windows® 95/98/NT

Question

Can I run on Windows® 95/98/NT?

Answer

No. These operating systems either do not support USB or have drivers that are not compatible.

Appendix A. PICKit Serial Analyzer Schematics

A.1 INTRODUCTION

This appendix contains the PICKit Serial Management hardware diagrams.

FIGURE A-1: PICKit™ SERIAL ANALYZER SCHEMATIC (SHEET 1 OF 2)

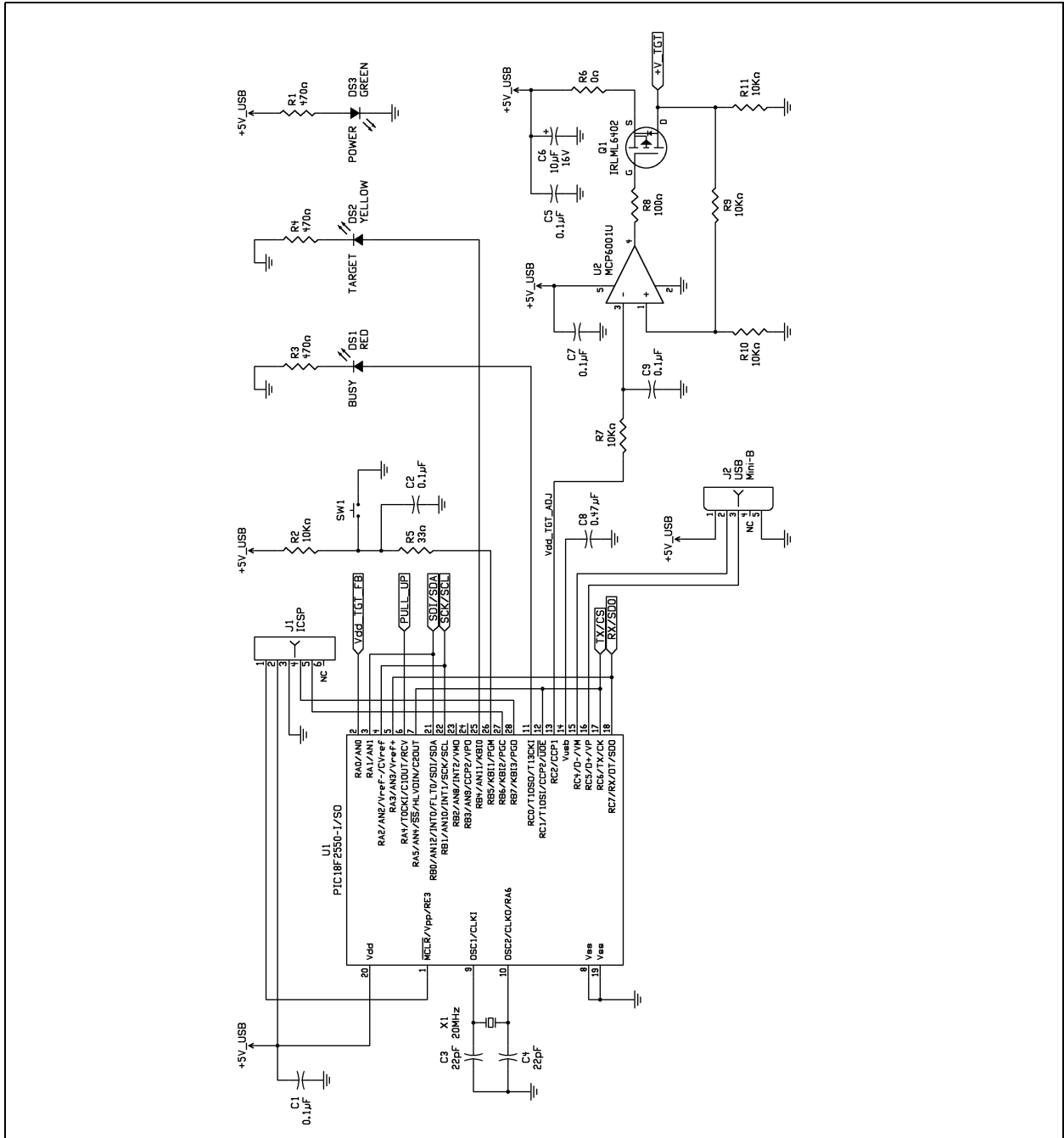

PICKit™ Serial Analyzer User's Guide

FIGURE A-2: PICKit™ SERIAL ANALYZER SCHEMATIC (SHEET 2 OF 2)

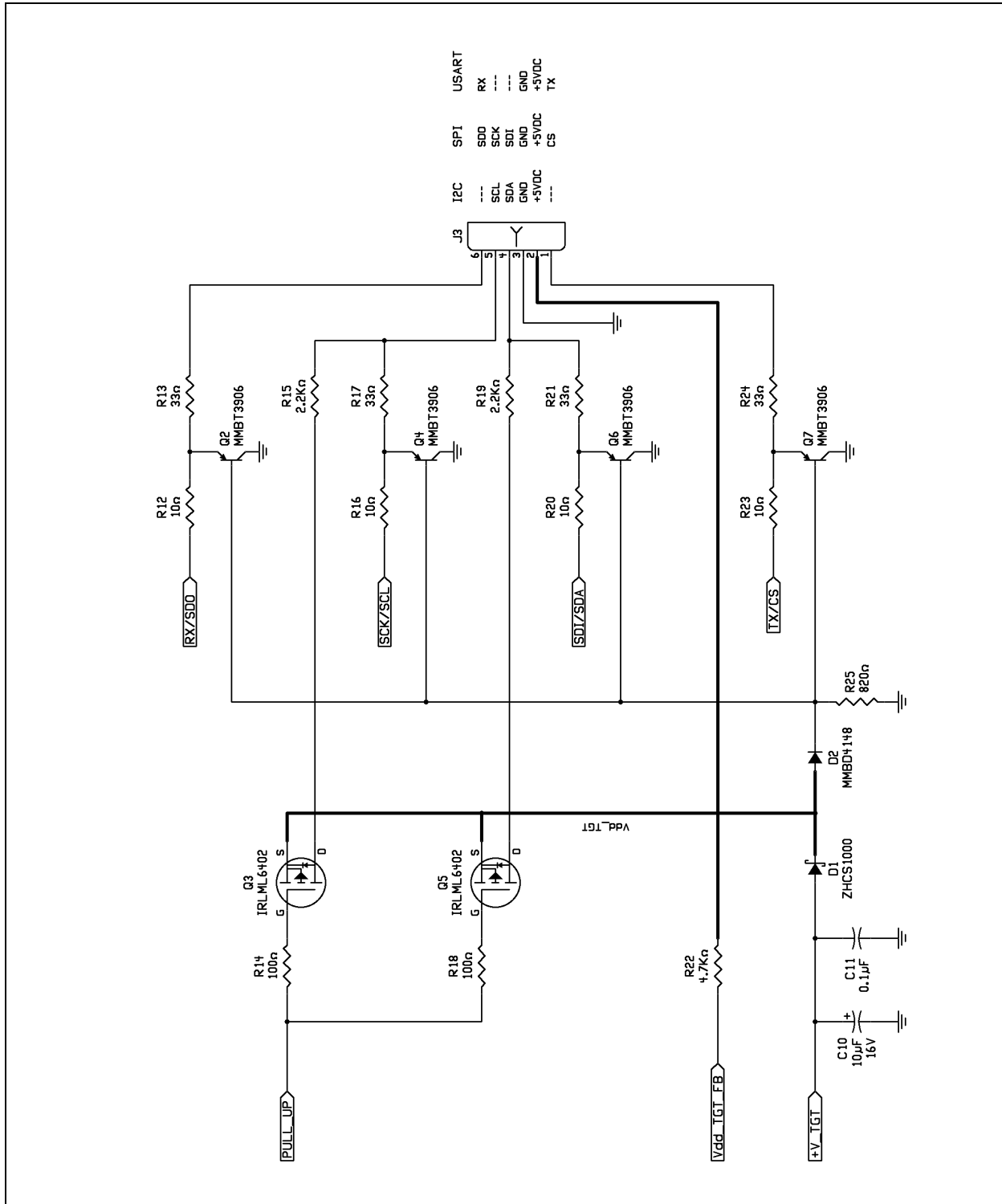

PICKit Serial Analyzer Schematics

FIGURE A-3: SILKSCREEN

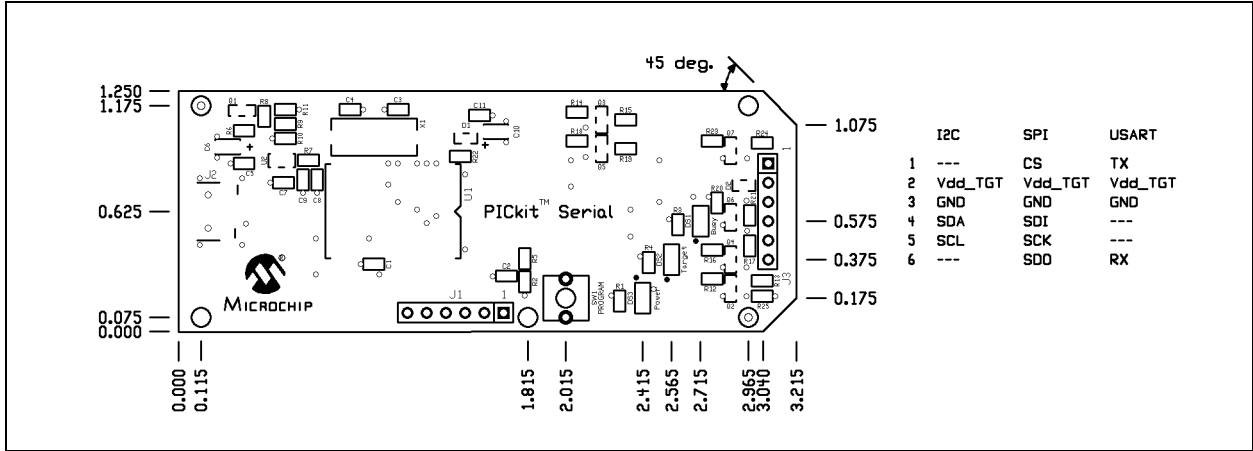

FIGURE A-4: TOP COPPER

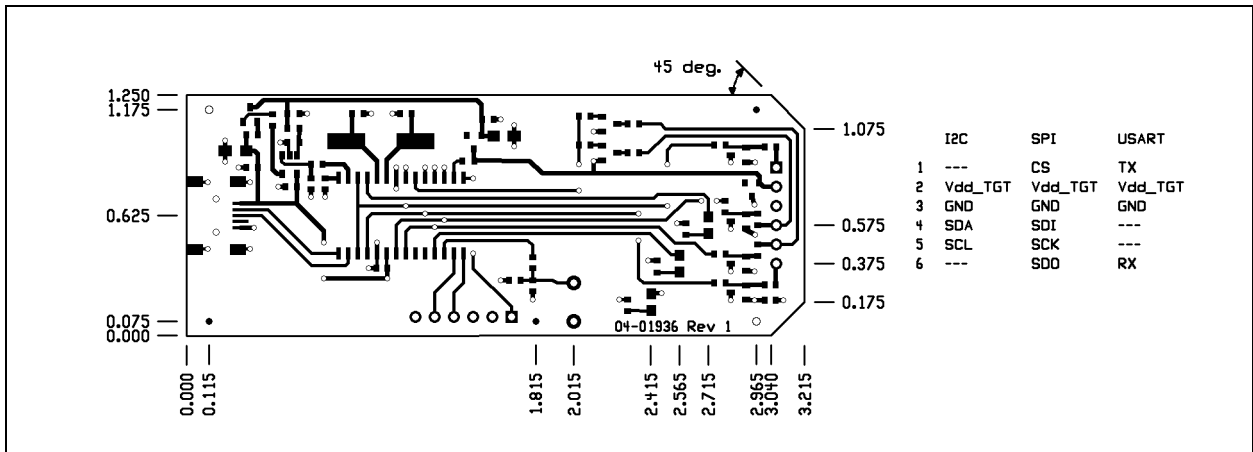
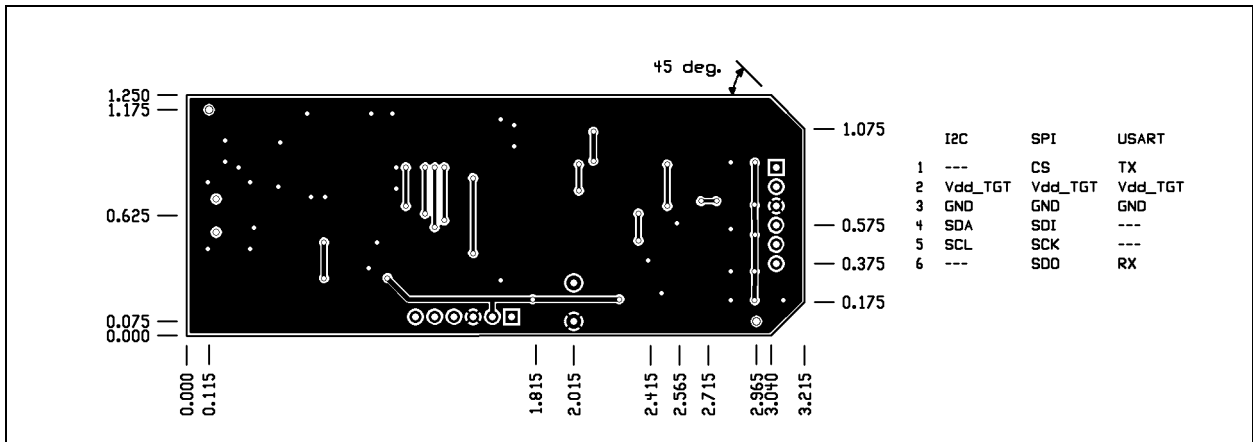

FIGURE A-5: BOTTOM COPPER



PICKit™ Serial Analyzer User's Guide

NOTES:

Appendix B. 28-Pin Demo Board I²C™ Demonstration Firmware

B.1 INTRODUCTION

The 28-Pin Demo Board I²C™ demonstration firmware communicates with the PICKit™ Serial Analyzer using the I²C serial protocol. The PICKit Serial Analyzer will be the I²C Master and the 28-Pin Demo Board will be the I²C Slave device. The 28-Pin Demo board is programmed to emulate an I²C Real-Time Clock (RTC) and Serial EEPROM.

B.2 HIGHLIGHTS

This chapter discusses:

- Hardware
- Firmware
- I²C Communications
- Slave Devices
- Functions

B.3 HARDWARE

The 28-Pin Demo Board (DM164120-3) is populated with and configured for:

- PIC16F886 configured using the 8 MHz internal clock
- 32 kHz Tuning Fork Crystal connected to Timer1 Low-power Oscillator
- Four LEDs (DS1 through DS4) connected to RB0 through RB3
- Potentiometer (RP1) connected to RA0/AN0
- Push button (SW1) connected to RE3/MCLR

For more information about the 28-Pin Demo Board hardware, see the 28-Pin Demo Board User's Guide (DS41301).

B.4 FIRMWARE

The demo program source code and *.hex file can be found on the PICKit Serial CD-ROM at D:\28-pin Demo Board\Firmware\.

The firmware is structured as multiple 'modules' representing functional components. Each module contains, at minimum, an "initialization" routine (MODULE_INIT) and a "service" routine (MODULE_SVC). Each initialization routine is called from MAIN once on Reset. Each Interrupt Service Routine is called sequentially and continuously from the MAIN Idle loop. Interrupt Service Routine is provided for the I²C module only. All other modules are serviced in turn from the MAIN 'Idle loop'.

PICKit™ Serial Analyzer User's Guide

TABLE B-1: FIRMWARE MODULES

MODULE	DESCRIPTION
adc.asm	ADC service – measuring channel AN0, connected to potentiometer RP1, and post results to register in shared memory
device.asm	Basic device (microcontroller) configuration
ee_util.asm	EEPROM Read/Write routines
exec.asm	“Executive” feature set – provides functionality for test and demonstration of PICKit™ Serial Analyzer and 28-Pin Demo Board
i2c_slave_pkasd.asm	I ² C™ service for three slave devices: 0xA2: Real-Time Clock (RTC) 0xA8: EEPROM 0xAA: Executive (EXEC)
led.asm	LED management, set/reset LEDs per state register
main.asm	Initialization, Idle loop and Interrupt Service Routine context management
pski.asm	Monitor PICKit Serial Analyzer interface I/O pins – post results to state register
rtc.asm	I ² C™ device: real-time clock emulation maintains 16 locations for register-based I/O
timer0.asm	Utilizes TMR0 as a source for multiple “soft” timers
timer1.asm	Utilizes TMR1 with external 32 kHz crystal for RTC 1-second ‘ticks’

B.5 I²C COMMUNICATIONS

B.5.1 Overview

The 28-Pin Demo Board I²C™ Demo responds to three I²C slave addresses:

TABLE B-2: DEVICE SLAVE ADDRESSES

ADDR	NAME	DESCRIPTION
0xA2	RTC	Device emulation: Real-Time Clock
0xA8	EEPROM	Device emulation: EEPROM
0xAA	EXEC	Supervisory features

All devices (slave addresses) respond to the I²C protocols described below. Each slave device supports a fixed number of word addresses (see section **B.6 Slave Devices** below). The word address is automatically incremented during a transaction for sequential access of the device registers. If the word address is incremented beyond the end of the supported address range, the address will “wrap”.

B.5.2 Protocols

Figure B-1 shows the Master and Slave legend used for Figures B-2 through B-4.

FIGURE B-1: MASTER/SLAVE DEVICE LEGEND

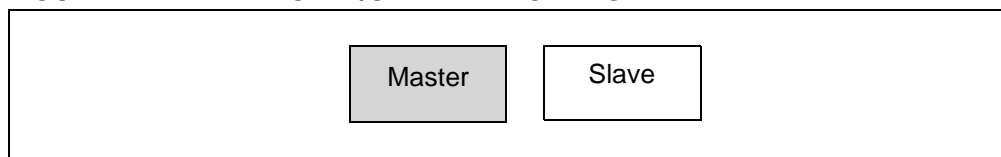

Write Byte(s) – This transaction is used to write one or more bytes. The maximum number of bytes is slave-dependant.

28-Pin Demo Board I²C™ Demonstration Firmware

FIGURE B-2: I²C™ WRITE BYTE(S)

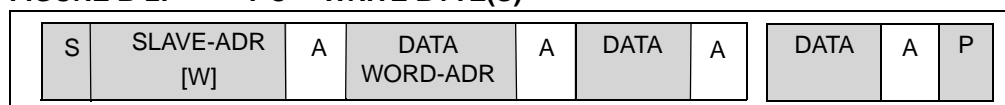

Read Byte(s) with Word Address – The word address is set to begin at a given value and incremented sequentially during the transaction.

FIGURE B-3: I²C™ READ BYTE(S) WITH WORD ADDRESS

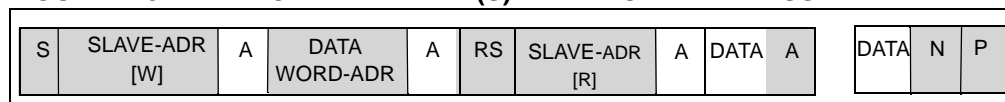

Read Byte(s) without Word Address – The word address will continue in sequence from the previous transaction to the I²C slave. On Reset the device address for all three slave devices are reset to zero.

FIGURE B-4: I²C™ READ BYTE(S) WITHOUT WORD ADDRESS

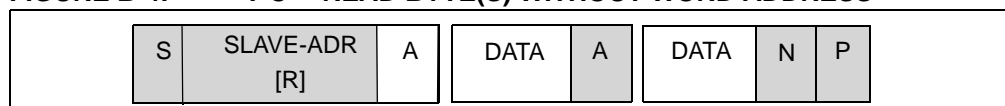

B.6 SLAVE DEVICES

The 28-Pin Demo Board I²C™ Demonstration firmware responds to three I²C slave devices: RTC, Serial EEPROM, and Executive.

B.6.1 Slave Address: 0xA2 – Real-Time Clock Emulation

The 28-Pin Demo Board I²C™ Demonstration emulates an I²C Real-Time Clock (RTC). Table B-3 list the word addresses.

TABLE B-3: REAL-TIME CLOCK (RTC) WORD ADDRESSES

REG	NAME	DESCRIPTION
0x00	RTC_CONFIG_1	7: 0 6: 0 5: STOP – stop time function (0: RUN, 1: STOP) 4: 0 3: 0 2: 0 1: 0 0: 0
0x01	RTC_CONFIG_2	7: 0 6: 0 5: 0 4: 0 3: AF – Alarm flag 2: 0 1: AE – Alarm enable 0: 0
0x02	RTC_SECONDS	00-59 seconds, coding: BCD, bit 7: VL?
0x03	RTC_MINUTES	00-59 minutes, coding: BCD
0x04	RTC_HOURS	00-23 hours, coding: BCD
0x05	RTC_WEEKDAY	00-06 weekday
0x06	RTC_DAYS	01-31 day of the month
0x07	RTC_MONTHS	01-12 month of the year, coding: BCD

TABLE B-3: REAL-TIME CLOCK (RTC) WORD ADDRESSES (CONTINUED)

0x08	RTC_YEARS	00-99 year, coding: BCD
0x09	RTC_ALARM_MIN	00-59 minute of alarm, coding: BCD bit 7: enable
0x0A	RTC_ALARM_HOUR	00-23 hour of alarm, coding: BCD bit 7: enable
0x0B	RTC_ALARM_DAY	01-31 day of alarm, coding BCD bit 7: enable
0x0C	RTC_ALARM_WEEK	00-06 weekday of alarm bit 7: enable
0x0D	(not assigned)	
0x0E	(not assigned)	
0x0F	(not assigned)	

B.6.2 Slave Address: 0xA8 – EEPROM Emulation

The 28-Pin Demo Board I²C™ Demonstration emulates a serial EEPROM. Device emulation provides for 256 bytes. A newly-programmed 28-Pin Demo Board defaults the first 8 bytes to 0x00 to 0x07 sequentially. The value of the remaining bytes is undefined / unknown.

A Read operation is executed during the transaction.

The Write operation begins after the Stop bit is received. The firmware will not respond to I²C communications during the Write.

FIGURE B-5: SERIAL EEPROM OPERATION

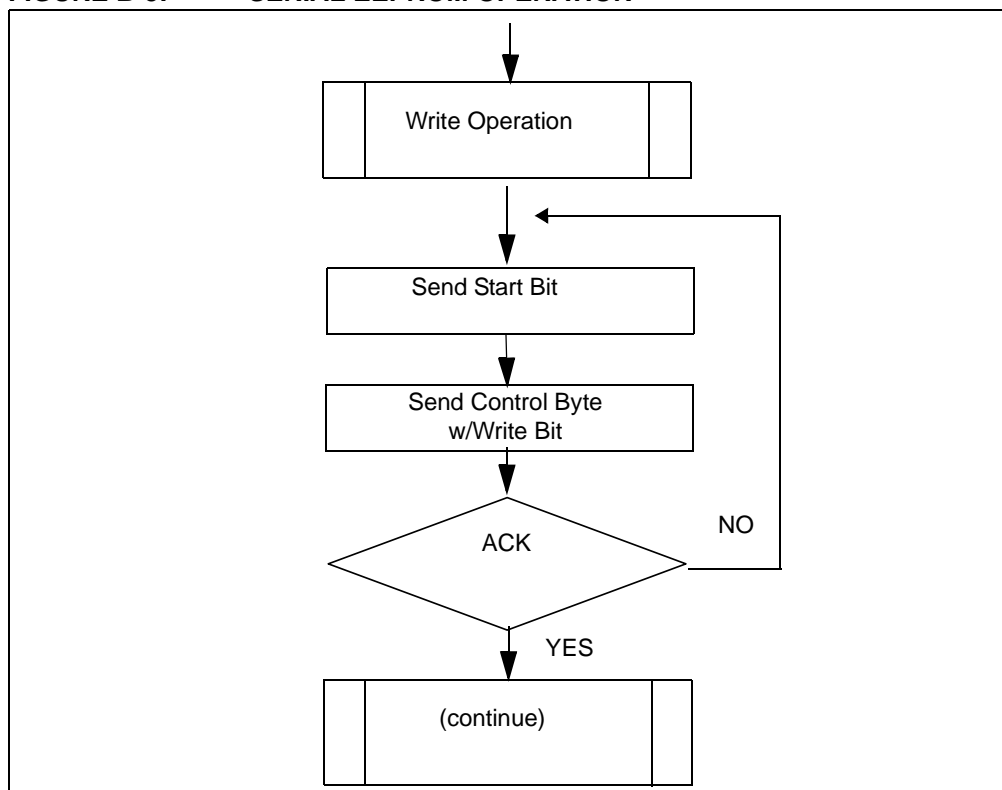

B.6.3 Slave Address: 0xAA – Executive (EXEC)

The “Executive” I²C pseudo device provides features convenient for testing and demonstrating the PICkit™ Serial Analyzer and the 28-Pin Demo Board I²C™ firmware. The I²C word addresses are listed in Table B-4.

28-Pin Demo Board I²C™ Demonstration Firmware

TABLE B-4: TABLE B-4 EXECUTIVE (EXEC) WORD ADDRESSES

REG	NAME	DESCRIPTION
0x00	EXEC_STATE	State of executive state controller bit 7 == 1: force state controller to one of eight "entry points" specified by bits[2:0]
0x01	EXEC_ADC_CH0	ADC results of CHANNEL AN0 (potentiometer RP1)
0x02	EXEC_RTC_SECS	binary value representation of RTC "SECONDS"
0x03	EXEC_STATUS	state of communications connector pins: bit 0: PIN 1 (AUX1) bit 1: PIN 4 (SDA) bit 2: PIN 5 (SCL) bit 3: PIN 6 (AUX2) bits[5:4]: undefined bit 6: operation error bit 7: operation busy
0x04	EXEC_04	undefined (can be read/written with no operational effect)
0x05	EXEC_05	undefined (can be read/written with no operational effect)
0x06	EXEC_06	undefined (can be read/written with no operational effect)
0x07	EXEC_VERSION	Firmware version number

State Controller – The Executive state controller manages background functions. The HOST enacts a function by writing to EXEC_STATE with a valid "state entry value" (i.e., 0x80-0x87). Writing values outside this range will cause unknown results.

TABLE B-5: EXEC STATE ENTRY VALUES

VALUE	NAME	DESCRIPTION
0x80	EXEC_DISPLAY_PING_PONG	display PING-PONG LED pattern: DS1,2,3,4,3,2,1,2 ...
0x81	EXEC_TIMER1_TEST	operation: timer1 test
0x82	EXEC_DISPLAY_ADC	display of Most Significant 4 bits of ADC results measuring variable resistor
0x83	EXEC_DISPLAY_RTC	display of RTC SECONDS (binary) – 0-15
0x84	EXEC_DISPLAY_PKSI	display of state of communications connector pins: LED1: PIN 1 (AUX1) LED2: PIN 4 (SDA) LED3: PIN 5 (SCA) LED4: PIN 6 (AUX2)
0x85	EXEC_DISPLAY_RESET	display 'RESET' sequence
0x86	EXEC_DISPLAY_1SEC	display – blink all LEDs – 1 sec ON, 1 sec OFF, ...
0x87	EXEC_0x87	undefined

B.7 FUNCTIONS

B.7.1 Ping-Pong Display

The PING-PONG display is useful in testing the four LEDs which are illuminated individually and in sequence as seen below. The following pattern is executed at a 100-millisecond step interval.

FIGURE B-6: PING-PONG LED PATTERN

DS1	DS2	DS3	DS3
On	Off	Off	Off
Off	On	Off	Off
Off	Off	On	Off
Off	Off	Off	On
Off	Off	On	Off
Off	On	Off	Off
On	Off	Off	Off

B.7.2 Timer1 Test

Timer1 Test provides a basic test of the auxiliary clock used for the RTC. The 28-Pin Demo Board employs a 32 kHz crystal on TIMER1 LP Oscillator to provide a 1-second interval for the RTC emulated device. The test begins by clearing the one-second flag, then waits a maximum of 1.1 seconds to see if the flag is reset. Alternatively, the HOST can test the RTC clock by examining EXEC REGISTER 0x02 at logically timed intervals.

FIGURE B-7: TIMER1 TEST

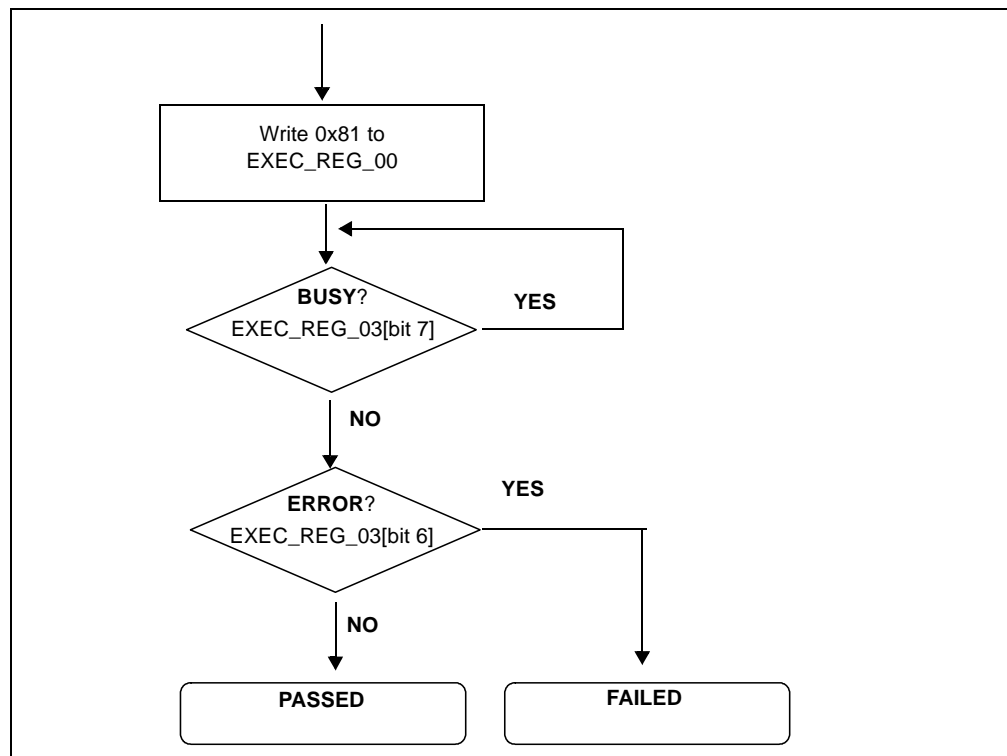

B.7.3 ADC Display

The ADC Display begins by displaying hex values 0x0A, 0x0D and 0x0C in sequence to signify “ADC” test.

After the opening display sequence, the LEDs displays the Most Significant 4 bits of the ADC result measuring channel AN0 (potentiometer RP1). As RP1 is manually turned from one extreme to the other, the LED display should range from binary 0000 to 1111. The firmware must be forced from this mode by command or Reset.

B.7.4 RTC Display

The RTC Display displays the Least Significant 4 bits of EXEC_REG_02 (RTC SECONDS). The LEDs should be seen to increment once per second in a binary progression (0x0-0xF) three times, then (0x0-0xB) once as the RTC SECONDS value increments from 0x00 to 0x3B (59 decimal). The firmware must be forced from this mode by command or Reset.

B.7.5 Communications Connector Display

This feature displays the state of the 4 signal pins on the communications connector.

LED1: PIN 1 (AUX1)

LED2: PIN 4 (SDA)

LED3: PIN 5 (SCL)

LED4: PIN 6 (AUX2)

Normally, LED2 and LED3 should be illuminated if the I²C bus has active pull-ups and the SCK is not held low. The firmware must be forced from this mode by command or Reset.

B.7.6 RESET Display

The RESET Display is executed on Reset/power-up or by command. The sequence is a series of individual displays as follows:

1. PING-PONG display: cycles: 2 (i.e., LED1,2,3,4,3,2,1,2,3,4,3,2,1)
2. Blink all LEDs in unison: cycles: 1 (i.e., 1 sec OFF, 1 sec ON, 1 sec OFF)
3. ADC display (described above): cycles: perpetual

B.7.7 1 Second Blink

Blink all LEDs in unison at 1-second intervals (i.e., 1 sec OFF, 1 sec ON, 1 sec OFF),...This feature uses time based on the Timer1 low-power oscillator and external 32 kHz tuning fork crystal.



WORLDWIDE SALES AND SERVICE

AMERICAS

Corporate Office
2355 West Chandler Blvd.
Chandler, AZ 85224-6199
Tel: 480-792-7200
Fax: 480-792-7277
Technical Support:
<http://support.microchip.com>
Web Address:
www.microchip.com

Atlanta
Duluth, GA
Tel: 678-957-9614
Fax: 678-957-1455

Boston
Westborough, MA
Tel: 774-760-0087
Fax: 774-760-0088

Chicago
Itasca, IL
Tel: 630-285-0071
Fax: 630-285-0075

Dallas
Addison, TX
Tel: 972-818-7423
Fax: 972-818-2924

Detroit
Farmington Hills, MI
Tel: 248-538-2250
Fax: 248-538-2260

Kokomo
Kokomo, IN
Tel: 765-864-8360
Fax: 765-864-8387

Los Angeles
Mission Viejo, CA
Tel: 949-462-9523
Fax: 949-462-9608

Santa Clara
Santa Clara, CA
Tel: 408-961-6444
Fax: 408-961-6445

Toronto
Mississauga, Ontario,
Canada
Tel: 905-673-0699
Fax: 905-673-6509

ASIA/PACIFIC

Asia Pacific Office
Suites 3707-14, 37th Floor
Tower 6, The Gateway
Harbour City, Kowloon
Hong Kong
Tel: 852-2401-1200
Fax: 852-2401-3431

Australia - Sydney
Tel: 61-2-9868-6733
Fax: 61-2-9868-6755

China - Beijing
Tel: 86-10-8528-2100
Fax: 86-10-8528-2104

China - Chengdu
Tel: 86-28-8665-5511
Fax: 86-28-8665-7889

China - Fuzhou
Tel: 86-591-8750-3506
Fax: 86-591-8750-3521

China - Hong Kong SAR
Tel: 852-2401-1200
Fax: 852-2401-3431

China - Qingdao
Tel: 86-532-8502-7355
Fax: 86-532-8502-7205

China - Shanghai
Tel: 86-21-5407-5533
Fax: 86-21-5407-5066

China - Shenyang
Tel: 86-24-2334-2829
Fax: 86-24-2334-2393

China - Shenzhen
Tel: 86-755-8203-2660
Fax: 86-755-8203-1760

China - Shunde
Tel: 86-757-2839-5507
Fax: 86-757-2839-5571

China - Wuhan
Tel: 86-27-5980-5300
Fax: 86-27-5980-5118

China - Xian
Tel: 86-29-8833-7250
Fax: 86-29-8833-7256

ASIA/PACIFIC

India - Bangalore
Tel: 91-80-4182-8400
Fax: 91-80-4182-8422

India - New Delhi
Tel: 91-11-4160-8631
Fax: 91-11-4160-8632

India - Pune
Tel: 91-20-2566-1512
Fax: 91-20-2566-1513

Japan - Yokohama
Tel: 81-45-471-6166
Fax: 81-45-471-6122

Korea - Gumi
Tel: 82-54-473-4301
Fax: 82-54-473-4302

Korea - Seoul
Tel: 82-2-554-7200
Fax: 82-2-558-5932 or
82-2-558-5934

Malaysia - Penang
Tel: 60-4-646-8870
Fax: 60-4-646-5086

Philippines - Manila
Tel: 63-2-634-9065
Fax: 63-2-634-9069

Singapore
Tel: 65-6334-8870
Fax: 65-6334-8850

Taiwan - Hsin Chu
Tel: 886-3-572-9526
Fax: 886-3-572-6459

Taiwan - Kaohsiung
Tel: 886-7-536-4818
Fax: 886-7-536-4803

Taiwan - Taipei
Tel: 886-2-2500-6610
Fax: 886-2-2508-0102

Thailand - Bangkok
Tel: 66-2-694-1351
Fax: 66-2-694-1350

EUROPE

Austria - Wels
Tel: 43-7242-2244-39
Fax: 43-7242-2244-393

Denmark - Copenhagen
Tel: 45-4450-2828
Fax: 45-4485-2829

France - Paris
Tel: 33-1-69-53-63-20
Fax: 33-1-69-30-90-79

Germany - Munich
Tel: 49-89-627-144-0
Fax: 49-89-627-144-44

Italy - Milan
Tel: 39-0331-742611
Fax: 39-0331-466781

Netherlands - Drunen
Tel: 31-416-690399
Fax: 31-416-690340

Spain - Madrid
Tel: 34-91-708-08-90
Fax: 34-91-708-08-91

UK - Wokingham
Tel: 44-118-921-5869
Fax: 44-118-921-5820

Компания «Life Electronics» занимается поставками электронных компонентов импортного и отечественного производства от производителей и со складов крупных дистрибьюторов Европы, Америки и Азии.

С конца 2013 года компания активно расширяет линейку поставок компонентов по направлению коаксиальный кабель, кварцевые генераторы и конденсаторы (керамические, пленочные, электролитические), за счёт заключения дистрибьюторских договоров

Мы предлагаем:

- Конкурентоспособные цены и скидки постоянным клиентам.
- Специальные условия для постоянных клиентов.
- Подбор аналогов.
- Поставку компонентов в любых объемах, удовлетворяющих вашим потребностям.
- Приемлемые сроки поставки, возможна ускоренная поставка.
- Доставку товара в любую точку России и стран СНГ.
- Комплексную поставку.
- Работу по проектам и поставку образцов.
- Формирование склада под заказчика.
- Сертификаты соответствия на поставляемую продукцию (по желанию клиента).
- Тестирование поставляемой продукции.
- Поставку компонентов, требующих военную и космическую приемку.
- Входной контроль качества.
- Наличие сертификата ISO.

В составе нашей компании организован Конструкторский отдел, призванный помогать разработчикам, и инженерам.

Конструкторский отдел помогает осуществить:

- Регистрацию проекта у производителя компонентов.
- Техническую поддержку проекта.
- Защиту от снятия компонента с производства.
- Оценку стоимости проекта по компонентам.
- Изготовление тестовой платы монтаж и пусконаладочные работы.



Тел: +7 (812) 336 43 04 (многоканальный)
Email: org@lifeelectronics.ru