

# Plastic Infrared Emitting Diode

## OP290 Series



### Features:

- Choice of narrow or wide irradiance pattern
- Choice of power ranges
- Choice of T-1 $\frac{3}{4}$ , TO-18 or T-46 package
- Higher power output than GaAs at equivalent LEDs

### Description:

Each device in this series, is a gallium aluminum arsenide infrared Light Emitting Diode (LED) that is molded in an IR-transmissive package with a wavelength centered at 890 nm, which closely matches the spectral response of silicon phototransistors, except for OP298 (AA, AB, AC, AD), which has either an 850 nm or 875 nm center wavelength. For identification purposes, each LED anode lead is longer than the cathode lead. **Package T-1 $\frac{3}{4}$**  devices include: **OP290, OP291, OP292, OP294, OP295, OP296, OP297, OP299 (A, B, C) and OP297FAB**, **Plastic Package TO-18 or TO-46** devices include: **OP293 and OP298 (A, B, C, AA, AD)**.

Each **OP290, OP291** and **OP292** series come in three electrical parameters options A, B and C. The **OP290** series forward current is specified under pulse conditions up to 1.5 amps, the **OP291** series forward current is specified under pulse conditions up to 100 milliamps and the **OP292** series forward current is specified under pulse conditions up to 1 amp. The Cathode Lead length is 0.06" (1.52 mm) shorter than the Anode Lead. The silver-copper lead frame offers excellent thermal characteristics.

Each **OP293** and **OP298** series come in three electrical parameter options A, B and C. The **OP293** series has an included emission angle of 60° while the **OP298** series has an included emission angle of 25°. The Cathode Lead length is 0.06" (1.52 mm) shorter than the Anode Lead. These devices, which come in a variety of power ranges offering a low cost replacement for TO-18 or TO-46 hermetic packages.

Each **OP298** series come with a high irradiance output versions with four electrical parameter options AA, AB, AC and AD. These power options are in the range of **5X** greater than the A, B or C options. The **OP298** series has an included emission angle of 25°. The Cathode Lead length is 0.06" (1.52 mm) shorter than the Anode Lead. These devices, which come in a variety of power ranges offering a low cost replacement for TO-18 or TO-46 hermetic packages.

**OP294** and **OP299** are designed for low-current or power-limited applications, such as battery supplies. They are similar to the **OP290** and **OP295**, but use a smaller chip that increases output efficiency at low current levels by increasing current density. Light output can be maximized with continuous (D.C.) forward current up to 100 mA or with pulsed forward current up to 750 mA. The Cathode Lead length is 0.06" (1.52 mm) shorter than the Anode Lead.

Each **OP295, OP296** and **OP297** series come in three electrical parameters options A, B and C. The **OP295** series forward current is specified under pulse conditions up to 5 amps, the **OP296** series forward current is specified under pulse conditions up to 2 amps and the **OP297** series forward current is specified under pulse conditions up to 1 amp. The Cathode Lead length is 0.06" (1.52 mm) shorter than the Anode Lead. The **OP297FAB** has a reversed polarity from the **OP297A, B**. The silver-copper lead frame offers excellent thermal characteristics.

*All of these devices are spectrally and mechanically matched to the OP593 and OP598 series phototransistors.*

Please refer to Application Bulletins 208 and 210 for additional design information and reliability (degradation) data.

### Applications:



RoHS

- Non-contact reflective object sensor
- Machine automation
- Door sensor
- Assembly line automation
- Machine safety
- Battery-operated applications
- End of travel sensor

### General Note

TT Electronics reserves the right to make changes in product specification without notice or liability. All information is subject to TT Electronics' own data and is considered accurate at time of going to print.

OPTEK Technology, Inc.  
1645 Wallace Drive, Carrollton, TX 75006 | Ph: +1 972 323 2200  
www.optekinc.com | www.ttelectronics.com

# Plastic Infrared Emitting Diode

## OP290 Series



### Part Number Guide — OP290 - OP299 Series

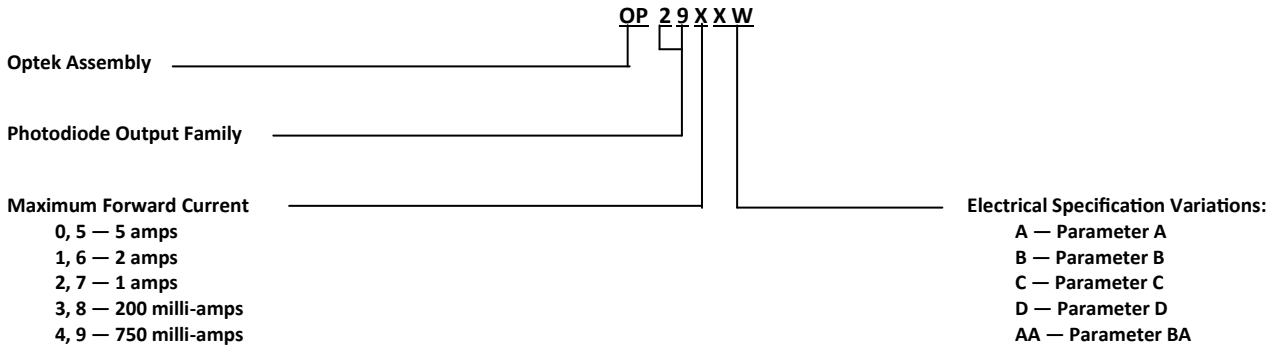

### T-1 1/4 Package OP290, OP291, OP292, OP294, OP295, OP296, OP297, OP299

#### Electrical Connection A, B, C, D

Pin #	LED X=0.060" (1.52 mm)
1	Anode
2	Cathode

#### Electrical Connection OP297AB

Pin #	LED X=0.060" (1.52 mm)
1	Cathode
2	Anode

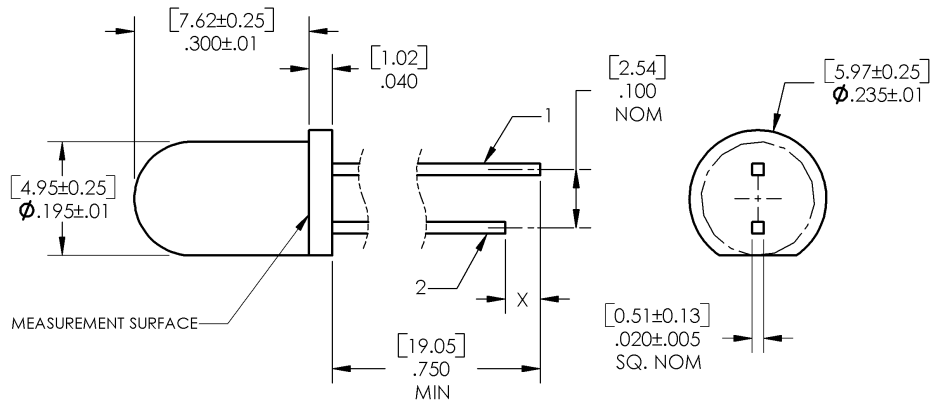

### TO-18, TO-46 Package OP293 & OP298



#### Electrical Connection A, B, C, AA, AB, AC, AD

Pin #	LED X=0.060" (1.52 mm)
1	Anode
2	Cathode

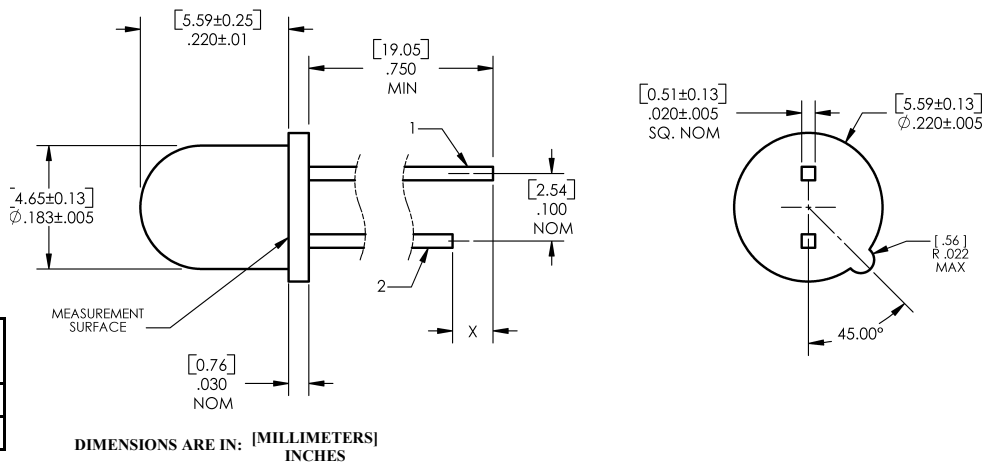

#### General Note

TT Electronics reserves the right to make changes in product specification without notice or liability. All information is subject to TT Electronics' own data and is considered accurate at time of going to print.

OPTEK Technology, Inc.  
 1645 Wallace Drive, Carrollton, TX 75006 | Ph: +1 972 323 2200  
 www.optekinc.com | www.ttelectronics.com

# Plastic Infrared Emitting Diode

## OP290 Series



### Electrical Specifications

Absolute Maximum Ratings ( $T_A = 25^\circ\text{C}$ unless otherwise noted)	
Storage and Operating Temperature Range	$-40^\circ\text{C}$ to $+100^\circ\text{C}$
Reverse Voltage OP290, OP292, OP294, OP295, OP297, OP299 OP291, OP293, OP296, OP298	5.0 V 2.0 V
Continuous Forward Current OP290, OP291, OP292 OP294, OP295, OP299 OP295, OP296, OP297	150 mA <sup>(1)</sup> 100 mA <sup>(1)</sup> 150 mA <sup>(1)</sup>
Continuous Forward Current, OP293, OP298 Free Air Board Mounted Full Heat Sink	100 mA 133 mA 200 mA
Peak Forward Current OP290, OP295 (25 $\mu\text{s}$ pulse width) OP291, OP296 (100 $\mu\text{s}$ pulse width) OP292, OP297 (100 $\mu\text{s}$ pulse width) OP293, OP298 (25 $\mu\text{s}$ pulse width) OP294, OP299	5.0 A 2.0 A 1.00 A 2.0 A 750 mA

Notes:

1. For OP290, OP291, OP292, OP295, OP296 and OP297, derate linearly 1.67 mA/ $^\circ\text{C}$  above 25 $^\circ\text{C}$  (free-air). When used with heat sink (see note 5), derate linearly 2.07 mA/ $^\circ\text{C}$  above 65 $^\circ\text{C}$  (normal use). For OP293 and OP298, when measured in free-air, derate power dissipation linearly 1.43 mW/ $^\circ\text{C}$  above 25 $^\circ\text{C}$ . For OP294 and OP299, derate linearly 1.80 mW/ $^\circ\text{C}$  above 25 $^\circ\text{C}$ .

General Note

TT Electronics reserves the right to make changes in product specification without notice or liability. All information is subject to TT Electronics' own data and is considered accurate at time of going to print.

OPTEK Technology, Inc.  
1645 Wallace Drive, Carrollton, TX 75006 | Ph: +1 972 323 2200  
www.optekinc.com | www.ttelectronics.com

### Electrical Specifications

<b>Absolute Maximum Ratings</b> ( $T_A = 25^\circ\text{C}$ unless otherwise noted)	
Maximum Duty Cycle OP290 (25 $\mu\text{s}$ pulse width @ 5 A)	1.25% <sup>(1)</sup>
Lead Soldering Temperature [1/16 inch (1.6 mm) from case for 5 seconds with soldering iron]	260° C <sup>(2)</sup>
Power Dissipation, Free Air OP290, OP291, OP292, OP295, OP296, OP297 OP293, OP298	333 mW <sup>(3)</sup> 142 mW <sup>(3)</sup>
Power Dissipation, Board Mounted OP290, OP291, OP292, op295, OP296, OP297 OP293, OP298	533 mW <sup>(4)</sup> 200 mW <sup>(4)</sup>
Power Dissipation, Full Heat Sink OP290, OP291, OP292, OP295, OP296, OP297 OP293, OP298	1.11 W <sup>(5)</sup> 400 mW <sup>(5)</sup>
Power Dissipation OP294, OP299	180 mW

**Notes:**

- For OP290, OP291, OP292, OP295, OP296 and OP297, refer to graph of Maximum Peak Pulse Current vs Pulse Width.
- For all OPs in this series, RMA flux is recommended. Duration can be extended to 10 second maximum when soldering. A maximum of 20 grams force may be applied to the leads when flow soldering.
- For OP290, OP291, OP292, OP295, OP296 and OP297, measured in free-air. Derate linearly 3.33 mW/°C above 25° C.
- For OP290, OP291 and OP292, mounted on 1/16" (1.6 mm) thick PCBoard with each lead soldered through 80 mil square lands 0.250" (6.35 mm) below flange of device. Derate linearly 5.33 mW/°C above 62.5°. For OP293 and OP298, mounted on 1/16" (1.60 mm) thick PCBoard with each lead soldered through 80 mil square lands 0.250" (6.35 mm) below flange of device. Derate power dissipation linearly 2.00 mW/°C above 25° C (normal use). For OP295, OP296 and OP297, mounted on 1/16" (1.6 mm) thick PCBoard with each lead soldered through 80 mil square lands 0.250" (6.35 mm) below flange of device. Derate linearly 5.33 mW/°C above 25° C.
- Immersed in silicone fluid to simulate infinite heat sink. For OP290, OP291 and OP292, derate linearly 11.1 mW/°C above 95°C. For OP293 and OP298, derate power dissipation linearly 2.50 mW/°C above 25° C. For OP295, OP296 and OP297, derate linearly 11.1 mW/°C above 25° C.

**General Note**

TT Electronics reserves the right to make changes in product specification without notice or liability. All information is subject to TT Electronics' own data and is considered accurate at time of going to print.

OPTEK Technology, Inc.  
1645 Wallace Drive, Carrollton, TX 75006 | Ph: +1 972 323 2200  
www.optekinc.com | www.ttelectronics.com

# Plastic Infrared Emitting Diode

## OP290 Series



### Electrical Specifications

Electrical Characteristics ( $T_A = 25^\circ \text{C}$ unless otherwise noted)							
SYMBOL	PARAMETER	MIN	TYP	MAX	UNITS	TEST CONDITIONS	
<b>Input Diode</b>							
$E_{E(APT)}^{(2)}$	Apertured Radiant Incidence						
	OP290A	210	-	-	mW/cm <sup>2</sup>	$I_F = 1.50 \text{ A}^{(1)(2)}$ Measured into a 0.250" [6.35mm] aperture 0.2" (5.08 mm) from the tip of the lens.	
	OP290B	180	-	300			
	OP290C	150	-	-			
	OP291A	16	-	-			$I_F = 100 \text{ mA}^{(1)(2)}$ Measured into a 0.250" [6.35mm] aperture 0.2" (5.08 mm) from the tip of the lens.
	OP291C	10	-	-			
	OP292A	2.7	-	-			$I_F = 20 \text{ mA}^{(1)(2)}$ Measured into a 0.250" [6.35mm] aperture 0.2" (5.08 mm) from the tip of the lens.
	OP293A	16	-	-			$I_F = 100 \text{ mA}^{(1)(2)}$ Measured into a 0.250" [6.35mm] aperture 0.2" (5.08 mm) from the tip of the lens.
	OP293B	13	22	26			
	OP293C	10	-	-			
	OP294	0.50	-	1.50			$I_F = 5 \text{ mA}^{(1)(2)}$ Measured into a 0.250" [6.35mm] aperture 0.200" (5.08mm) from the tip of the lens.
	OP295A	44	-	-			$I_F = 1.50 \text{ A}^{(1)(2)}$ Measured into a 0.250" [6.35mm] aperture 1.129" (28.7 mm) from the tip of the lens.
	OP295B	33	-	77			
OP296A	3.6	-	-	$I_F = 100 \text{ mA}^{(1)(2)}$ Measured into a 0.250" [6.35mm] aperture 1.129" (28.7 mm) from the tip of the lens.			
OP296B	2.6	-	6.6				
OP297FAB	2.4	-	-	$I_F = 20 \text{ mA}^{(1)(2)}$ Measured into a 0.250" [6.35mm] aperture 1.129" (28.7 mm) from the tip of the lens.			
OP297A	0.7	-	-				
OP297B	0.5	1.0	1.3				
OP298A	3.0	-	-	$I_F = 100 \text{ mA}^{(1)(2)}$ Measured into a 0.250" [6.35mm] aperture 0.2" (5.08 mm) from the tip of the lens.			
OP298B	2.4	-	4.8				
OP298C	1.8	-	-				
OP298AA	3.5	-	-	$I_F = 100 \text{ mA}^{(1)(2)}$ Measured into a 0.250" [6.35mm] aperture 1.129" (28.7 mm) from the tip of the lens.			
OP298AD	8.5	-	-				
OP299	0.15	-	0.45	$I_F = 100 \text{ mA}^{(1)(2)}$ Measured into a 0.250" [6.35mm] aperture 1.129" (28.7 mm) from the tip of the lens.			

Notes:

1. Measurement is taken at the end of a single 100  $\mu\text{s}$  pulse. Heating due to increased pulse rate or pulse width will cause a decrease in reading.
2. Measurement of the average apertured radiant energy incident upon a sensing area 0.250" (6.35 mm) in diameter perpendicular to and centered on the mechanical axis of the lens and the specified distance from the end of the device. On all models in this series,  $E_{E(APT)}$  is not necessarily uniform within the measured area.
3. Measurement is taken at the end of a single 10 ms pulse. Heating due to increased pulse rate or pulse width will cause a decrease in reading.

General Note

TT Electronics reserves the right to make changes in product specification without notice or liability. All information is subject to TT Electronics' own data and is considered accurate at time of going to print.

OPTEK Technology, Inc.  
1645 Wallace Drive, Carrollton, TX 75006 | Ph: +1 972 323 2200  
www.optekinc.com | www.ttelectronics.com

# Plastic Infrared Emitting Diode

OP290 Series



## Electrical Specifications

Electrical Characteristics (T <sub>A</sub> = 25° C unless otherwise noted)						
SYMBOL	PARAMETER	MIN	TYP	MAX	UNITS	TEST CONDITIONS
<b>Input Diode</b>						
V <sub>F</sub>	Forward Voltage <sup>(3)</sup> OP290, OP295 OP291, OP296 OP292, OP297, OP297FAB OP293, OP298 (A, B, C) OP298 (AA, AD) OP294, OP299	-	-	4.00 2.00 1.75 2.00 2.00 1.50	V	I <sub>F</sub> = 1.50 A I <sub>F</sub> = 100 mA I <sub>F</sub> = 20 mA I <sub>F</sub> = 1.50 A I <sub>F</sub> = 100 mA I <sub>F</sub> = 5 mA
I <sub>R</sub>	Reverse Current <sup>(3)</sup> OP290, OP292 OP291, OP293, OP298 (A, B, C), OP296 OP298 (AA, AD) OP294, OP299 OP295, OP297 OP297FAB	-	-	10 100 100 10 10 15	μA	V <sub>R</sub> = 5 V V <sub>R</sub> = 2 V V <sub>R</sub> = 2 V V <sub>R</sub> = 2 V V <sub>R</sub> = 5 V V <sub>R</sub> = 5 V
λ <sub>P</sub>	Wavelength at Peak Emission OP290, OP291, OP292, OP293, OP294, OP295, OP296, OP297, OP298 (A, B, C), OP299 OP297FAB, OP298 (AA, AD)	-	890 875	-	nm	I <sub>F</sub> = 10 mA
B	Spectral Bandwidth between Half Power Points	-	80	-	nm	I <sub>F</sub> = 10 mA
Δλ <sub>P</sub> /ΔT	Spectral Shift with Temperature	-	+0.18	-	nm/°C	I <sub>F</sub> = Constant
θ <sub>HP</sub>	Emission Angle at Half Power Points OP290, OP291, OP292, OP294 OP293 OP295, OP296, OP297, OP299 OP298	-	50 60 20 25	-	Degree	I <sub>F</sub> = 20 mA
t <sub>r</sub>	Output Rise Time	-	500	-	ns	I <sub>F(PK)</sub> =100 mA, PW=10 μs, and D.C.=10.0%
t <sub>f</sub>	Output Fall Time	-	250	-	ns	

**General Note**

TT Electronics reserves the right to make changes in product specification without notice or liability. All information is subject to TT Electronics' own data and is considered accurate at time of going to print.

OPTEK Technology, Inc.  
1645 Wallace Drive, Carrollton, TX 75006 | Ph: +1 972 323 2200  
www.optekinc.com | www.ttelectronics.com

# Plastic Infrared Emitting Diode

OP290 Series



## Performance OP290, OP291, OP292, OP293, OP294, (A, C)

Forward Voltage vs Forward Current vs Temp.

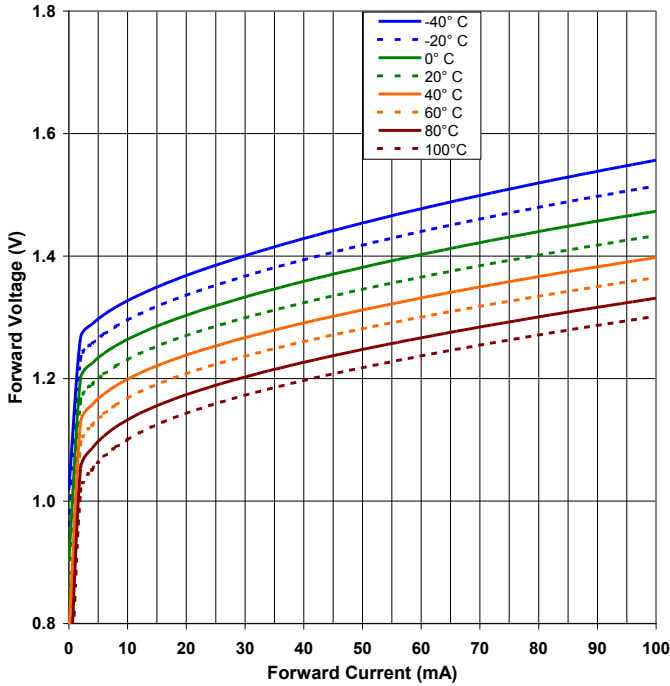

Optical Power vs Forward Current vs Temperature

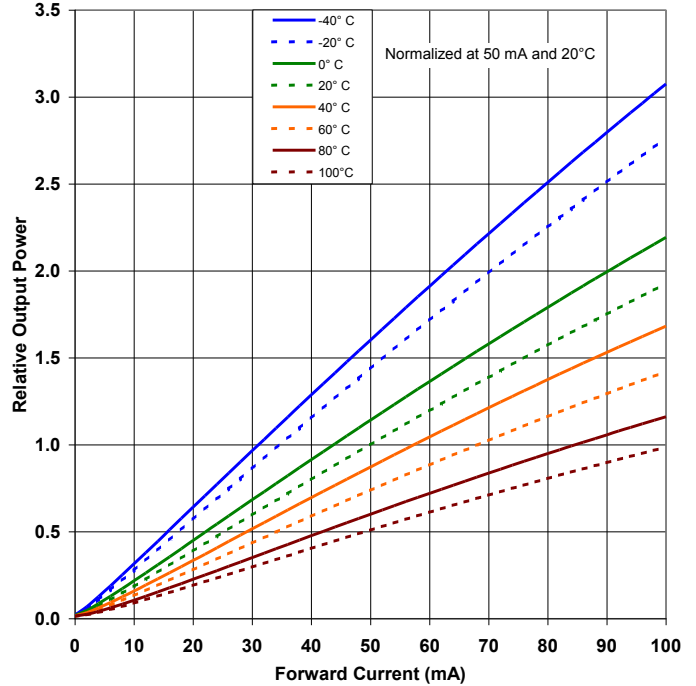

Distance vs Output Power vs Forward Current

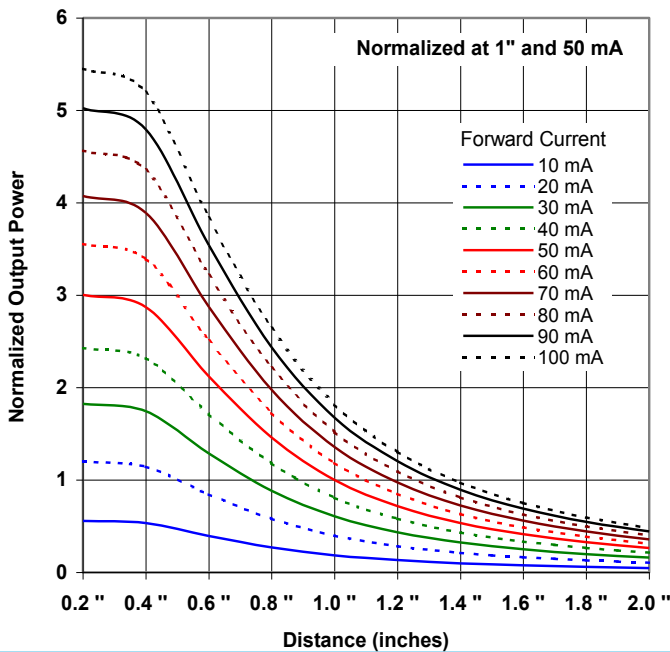

Relative Radiant Intensity vs. Angular Displacement

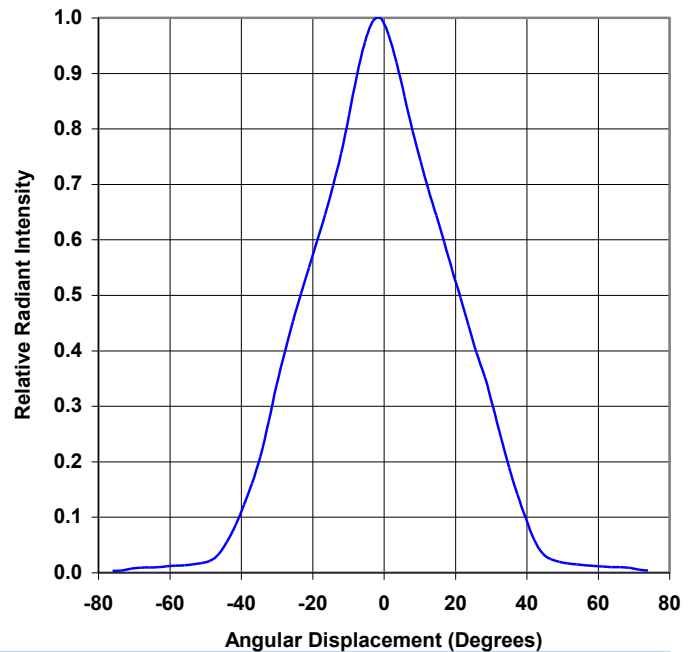

General Note  
TT Electronics reserves the right to make changes in product specification without notice or liability. All information is subject to TT Electronics' own data and is considered accurate at time of going to print.

OPTEK Technology, Inc.  
1645 Wallace Drive, Carrollton, TX 75006 | Ph: +1 972 323 2200  
www.optekinc.com | www.ttelectronics.com

# Plastic Infrared Emitting Diode

OP290 Series



## Performance

OP295, OP296, OP297, OP298, OP299

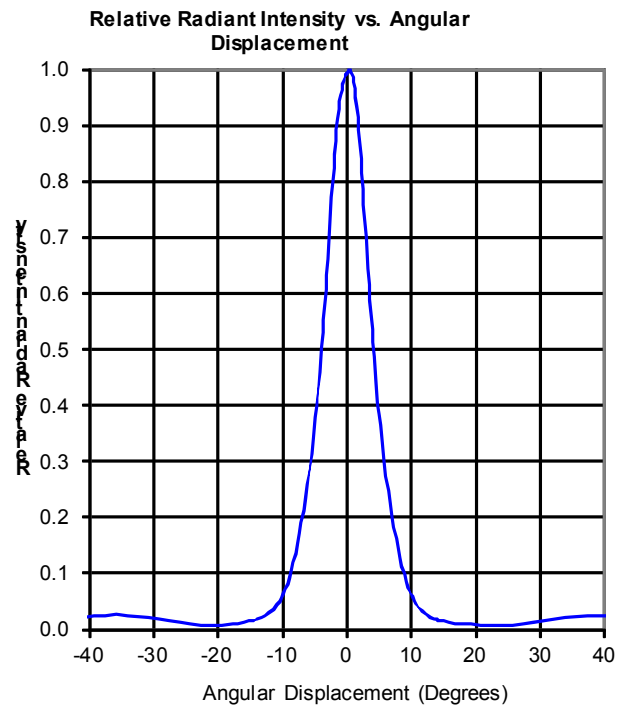
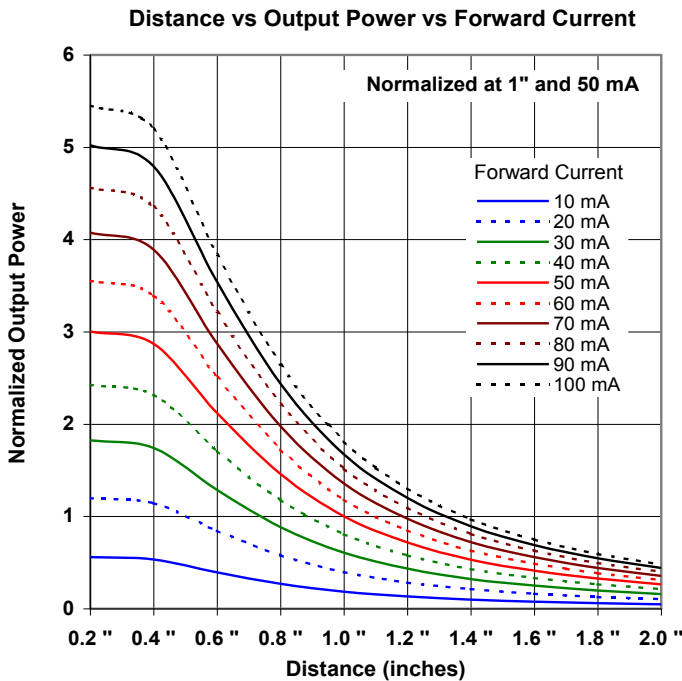
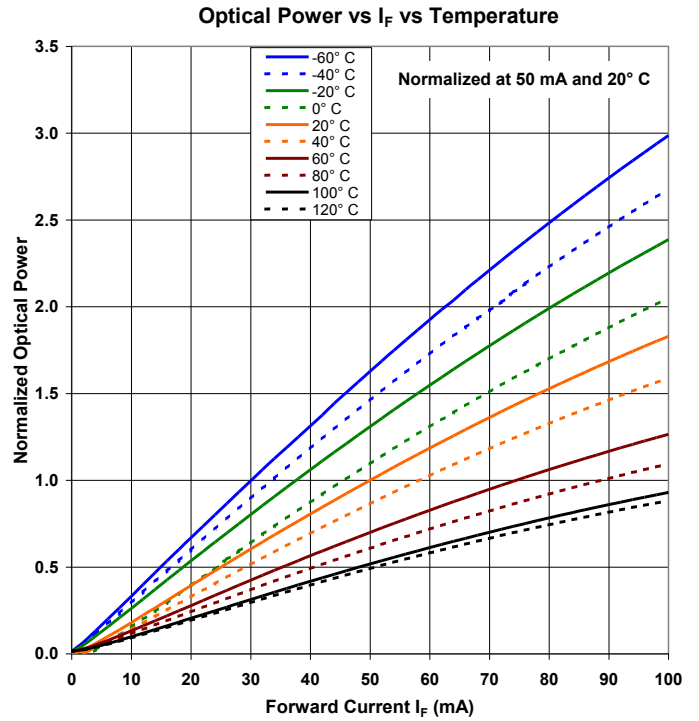
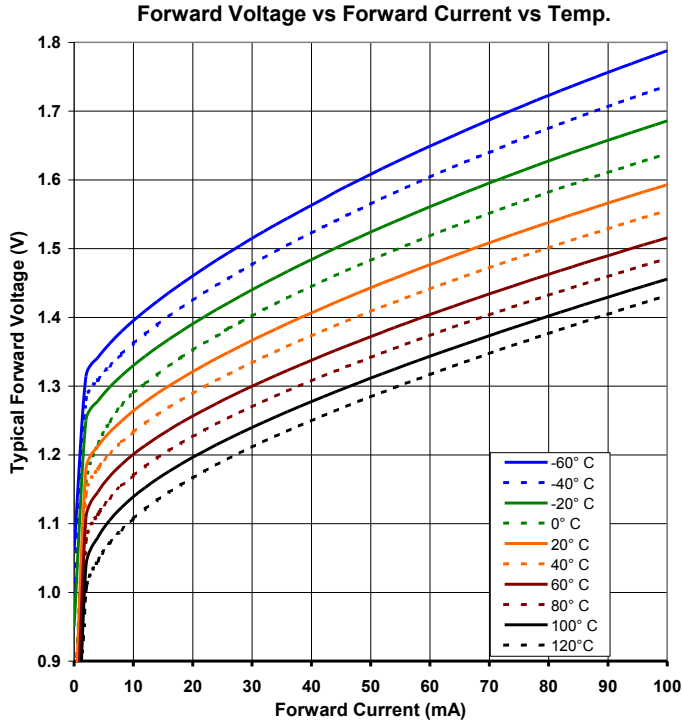

**General Note**

TT Electronics reserves the right to make changes in product specification without notice or liability. All information is subject to TT Electronics' own data and is considered accurate at time of going to print.



### Performance

#### OP290A/OP593 and OP295/OP598 - Coupling Characteristics

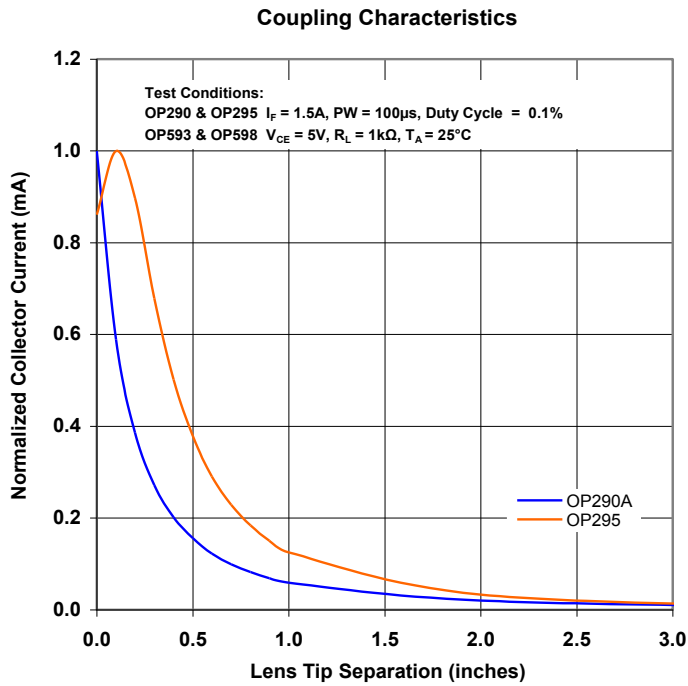

**General Note**

TT Electronics reserves the right to make changes in product specification without notice or liability. All information is subject to TT Electronics' own data and is considered accurate at time of going to print.

OPTEK Technology, Inc.  
1645 Wallace Drive, Carrollton, TX 75006 | Ph: +1 972 323 2200  
www.optekinc.com | www.ttelectronics.com

Компания «Life Electronics» занимается поставками электронных компонентов импортного и отечественного производства от производителей и со складов крупных дистрибьюторов Европы, Америки и Азии.

С конца 2013 года компания активно расширяет линейку поставок компонентов по направлению коаксиальный кабель, кварцевые генераторы и конденсаторы (керамические, пленочные, электролитические), за счёт заключения дистрибьюторских договоров

Мы предлагаем:

- Конкурентоспособные цены и скидки постоянным клиентам.
- Специальные условия для постоянных клиентов.
- Подбор аналогов.
- Поставку компонентов в любых объемах, удовлетворяющих вашим потребностям.
- Приемлемые сроки поставки, возможна ускоренная поставка.
- Доставку товара в любую точку России и стран СНГ.
- Комплексную поставку.
- Работу по проектам и поставку образцов.
- Формирование склада под заказчика.
- Сертификаты соответствия на поставляемую продукцию (по желанию клиента).
- Тестирование поставляемой продукции.
- Поставку компонентов, требующих военную и космическую приемку.
- Входной контроль качества.
- Наличие сертификата ISO.

В составе нашей компании организован Конструкторский отдел, призванный помогать разработчикам, и инженерам.

Конструкторский отдел помогает осуществить:

- Регистрацию проекта у производителя компонентов.
- Техническую поддержку проекта.
- Защиту от снятия компонента с производства.
- Оценку стоимости проекта по компонентам.
- Изготовление тестовой платы монтаж и пусконаладочные работы.



Тел: +7 (812) 336 43 04 (многоканальный)

Email: [org@lifeelectronics.ru](mailto:org@lifeelectronics.ru)