

Trench gate field-stop IGBT, HB series 650 V, 40 A high speed

Datasheet - production data

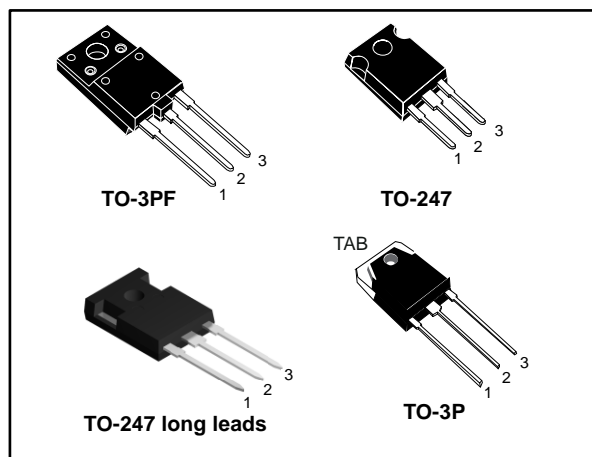

Figure 1: Internal schematic diagram

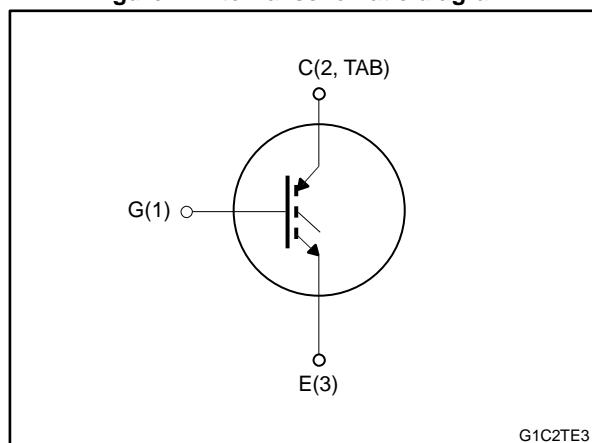

Table 1: Device summary

Order code	Marking	Package	Packing
STGFW40H65FB	GFW40H65FB	TO-3PF	Tube
STGW40H65FB	GW40H65FB	TO-247	Tube
STGWA40H65FB	GWA40H65FB	TO-247 long leads	Tube
STGWT40H65FB	GWT40H65FB	TO-3P	Tube

Features

- Maximum junction temperature: $T_J = 175\text{ }^\circ\text{C}$
- High speed switching series
- Minimized tail current
- Very low saturation voltage: $V_{CE(sat)} = 1.6\text{ V}$ (typ) @ $I_C = 40\text{ A}$
- Safe paralleling
- Tight parameter distribution
- Low thermal resistance

Applications

- Photovoltaic inverters
- High frequency converters

Description

These devices are IGBTs developed using an advanced proprietary trench gate field-stop structure. These devices are part of the new HB series of IGBTs, which represent an optimum compromise between conduction and switching loss to maximize the efficiency of any frequency converter. Furthermore, the slightly positive $V_{CE(sat)}$ temperature coefficient and very tight parameter distribution result in safer paralleling operation.

Contents

1	Electrical ratings	3
2	Electrical characteristics	4
	2.1 Electrical characteristics (curves)	6
3	Test circuits	11
4	Package information	12
	4.1 TO-3PF package information	12
	4.2 TO-247 package information	14
	4.3 TO-247 long leads package information	16
	4.4 TO-3P package information	18
5	Revision history	20

1 Electrical ratings

Table 2: Absolute maximum ratings

Symbol	Parameter	Value		Unit
		TO-247, TO-247 long leads, TO-3P	TO-3PF	
V _{CEs}	Collector-emitter voltage (V _{GE} = 0 V)	650		V
I _C	Continuous collector current at T _C = 25 °C	80		A
	Continuous collector current at T _C = 100 °C	40		
I _{CP} ⁽¹⁾	Pulsed collector current	160		A
V _{GE}	Gate-emitter voltage	±20		V
P _{TOT}	Total dissipation at T _C = 25 °C	283	62.5	W
V _{ISO}	Insulation withstand voltage (RMS) from all three leads to external heat sink (t = 1 s; T _C = 25 °C)		3.5	kV
T _{STG}	Storage temperature range	-55 to 150		°C
T _J	Operating junction temperature range	-55 to 175		°C

Notes:

⁽¹⁾Pulse width is limited by maximum junction temperature.

Table 3: Thermal data

Symbol	Parameter	Value		Unit
		TO-247, TO-247 long leads, TO-3P	TO-3PF	
R _{thJC}	Thermal resistance junction-case	0.53	2.4	°C/W
R _{thJA}	Thermal resistance junction-ambient	50		°C/W

2 Electrical characteristics

$T_C = 25\text{ °C}$ unless otherwise specified

Table 4: Static characteristics

Symbol	Parameter	Test conditions	Min.	Typ.	Max.	Unit
$V_{(BR)CES}$	Collector-emitter breakdown voltage	$V_{GE} = 0\text{ V}$, $I_C = 2\text{ mA}$	650			V
$V_{CE(sat)}$	Collector-emitter saturation voltage	$V_{GE} = 15\text{ V}$, $I_C = 40\text{ A}$		1.6	2	V
		$V_{GE} = 15\text{ V}$, $I_C = 40\text{ A}$, $T_J = 125\text{ °C}$		1.7		
		$V_{GE} = 15\text{ V}$, $I_C = 40\text{ A}$, $T_J = 175\text{ °C}$		1.8		
$V_{GE(th)}$	Gate threshold voltage	$V_{CE} = V_{GE}$, $I_C = 1\text{ mA}$	5	6	7	V
I_{CES}	Collector cut-off current	$V_{GE} = 0\text{ V}$, $V_{CE} = 650\text{ V}$			25	μA
I_{GES}	Gate-emitter leakage current	$V_{CE} = 0\text{ V}$, $V_{GE} = \pm 20\text{ V}$			± 250	nA

Table 5: Dynamic characteristics

Symbol	Parameter	Test conditions	Min.	Typ.	Max.	Unit
C_{ies}	Input capacitance	$V_{CE} = 25\text{ V}$, $f = 1\text{ MHz}$, $V_{GE} = 0\text{ V}$	-	5412	-	pF
C_{oes}	Output capacitance		-	198	-	
C_{res}	Reverse transfer capacitance		-	107	-	
Q_g	Total gate charge	$V_{CC} = 520\text{ V}$, $I_C = 40\text{ A}$, $V_{GE} = 0\text{ to }15\text{ V}$ (see Figure 28: "Gate charge test circuit")	-	210	-	nC
Q_{ge}	Gate-emitter charge		-	39	-	
Q_{gc}	Gate-collector charge		-	82	-	

Table 6: Switching characteristics (inductive load)

Symbol	Parameter	Test conditions	Min.	Typ.	Max.	Unit
$t_{d(on)}$	Turn-on delay time	$V_{CE} = 400\text{ V}$, $I_C = 40\text{ A}$, $V_{GE} = 15\text{ V}$, $R_G = 5\ \Omega$ (see Figure 27: "Test circuit for inductive load switching")	-	40	-	ns
t_r	Current rise time		-	13	-	
$(di/dt)_{on}$	Turn-on current slope		-	2413	-	A/ μ s
$t_{d(off)}$	Turn-off delay time		-	142	-	ns
t_f	Current fall time		-	27	-	
$E_{on}^{(1)}$	Turn-on switching energy		-	498	-	μ J
$E_{off}^{(2)}$	Turn-off switching energy		-	363	-	
E_{ts}	Total switching energy	-	861	-		
$t_{d(on)}$	Turn-on delay time	$V_{CE} = 400\text{ V}$, $I_C = 40\text{ A}$, $V_{GE} = 15\text{ V}$, $R_G = 5\ \Omega$, $T_J = 175\text{ }^\circ\text{C}$ (see Figure 27: "Test circuit for inductive load switching")	-	38	-	ns
t_r	Current rise time		-	14	-	
$(di/dt)_{on}$	Turn-on current slope		-	2186	-	A/ μ s
$t_{d(off)}$	Turn-off delay time		-	141	-	ns
t_f	Current fall time		-	61	-	
$E_{on}^{(1)}$	Turn-on switching energy		-	1417	-	μ J
$E_{off}^{(2)}$	Turn-off switching energy		-	764	-	
E_{ts}	Total switching energy	-	2181	-		

Notes:

⁽¹⁾Including the reverse recovery of the external diode. The diode is the same of the co-packed STGW40H65DFB.

⁽²⁾Including the tail of the collector current.

2.1 Electrical characteristics (curves)

Figure 2: Power dissipation vs. case temperature for TO-247, TO-247 long leads and TO-3P

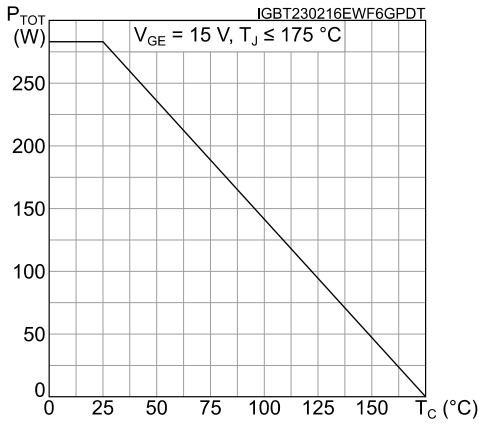

Figure 3: Collector current vs. case temperature for TO-247, TO-247 long leads and TO-3P

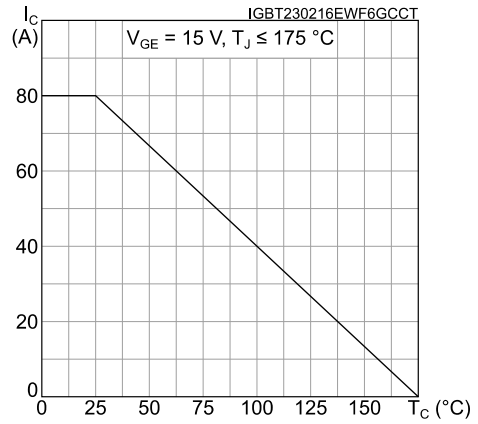

Figure 4: Power dissipation vs. case temperature for TO-3PF

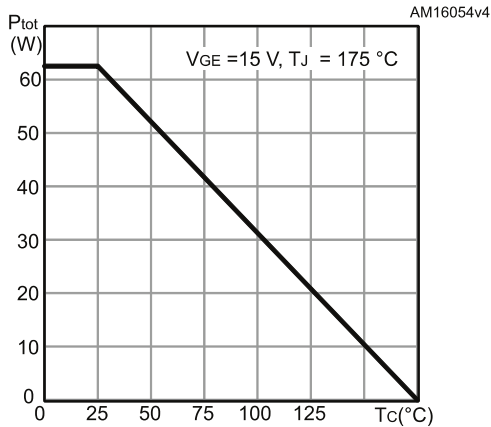

Figure 5: Collector current vs. case temperature for TO-3PF

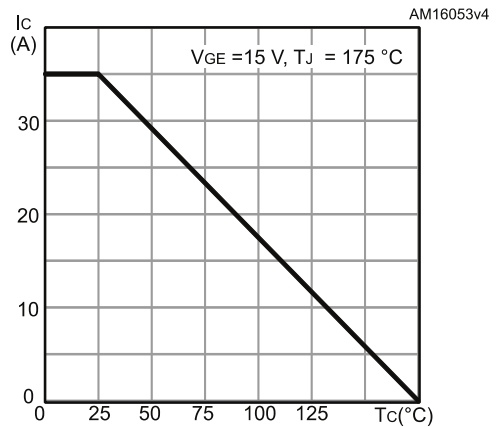

Figure 6: Output characteristics (T_J = 25 °C)

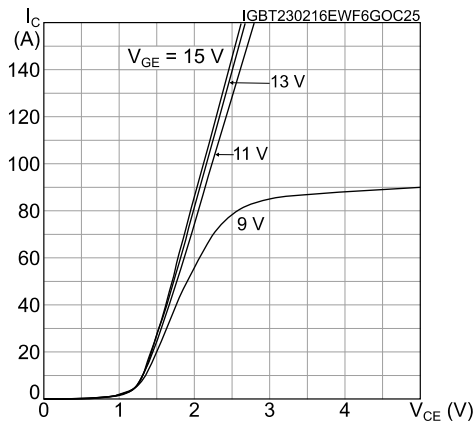
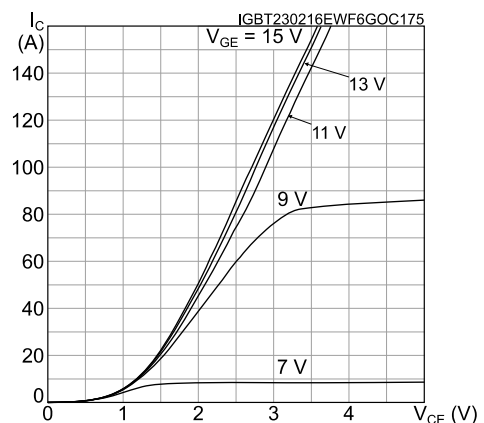
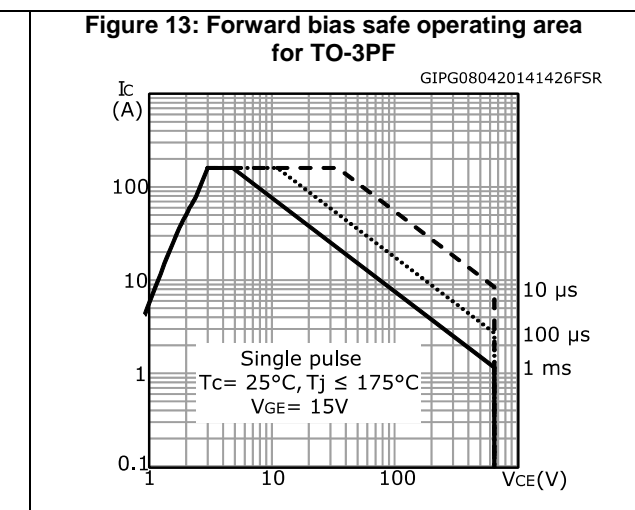
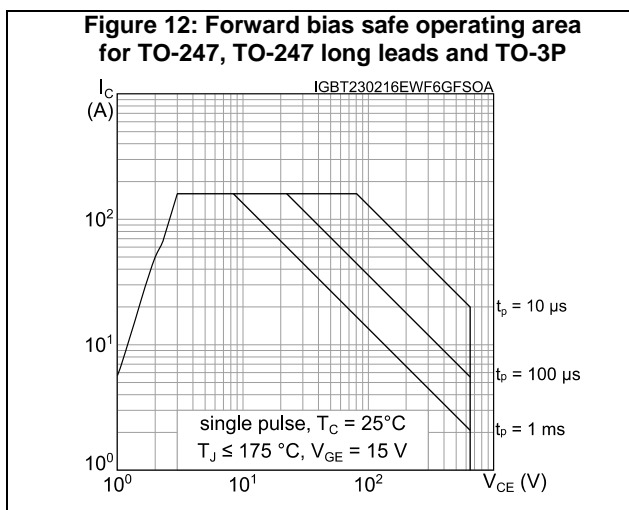
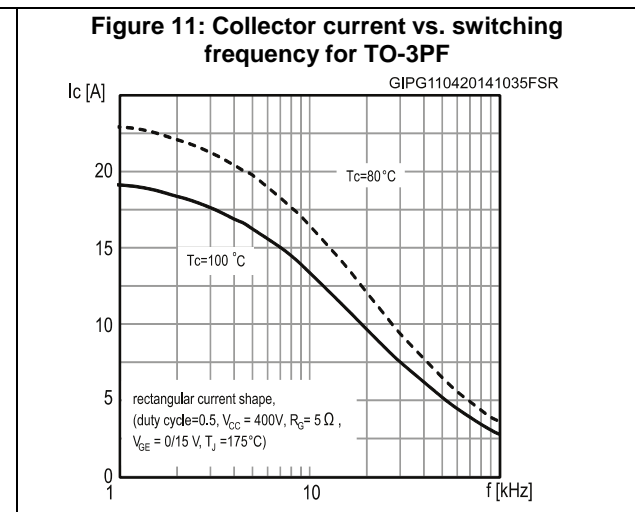
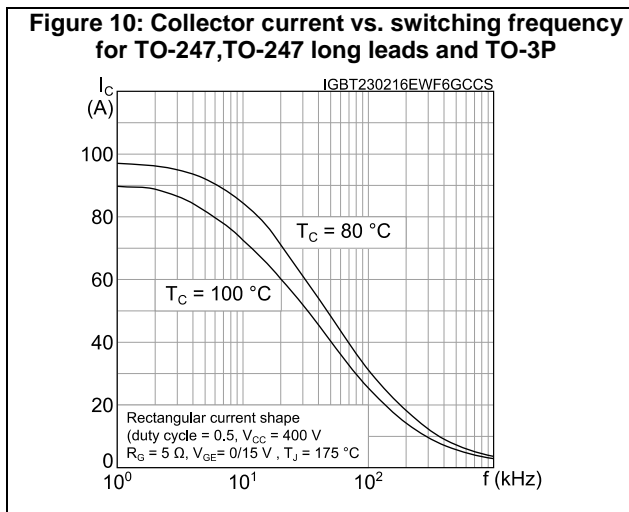
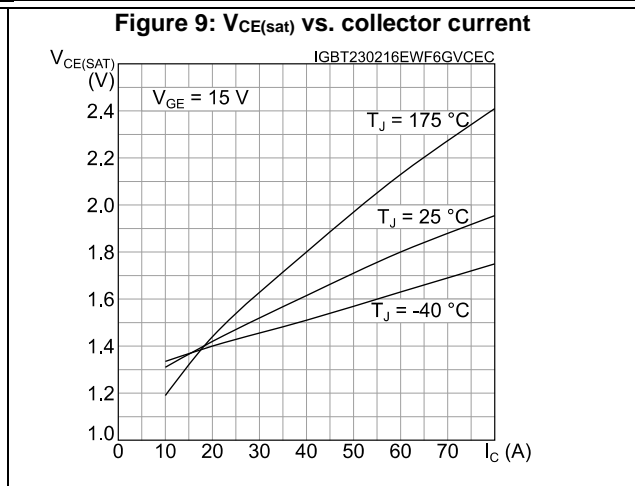
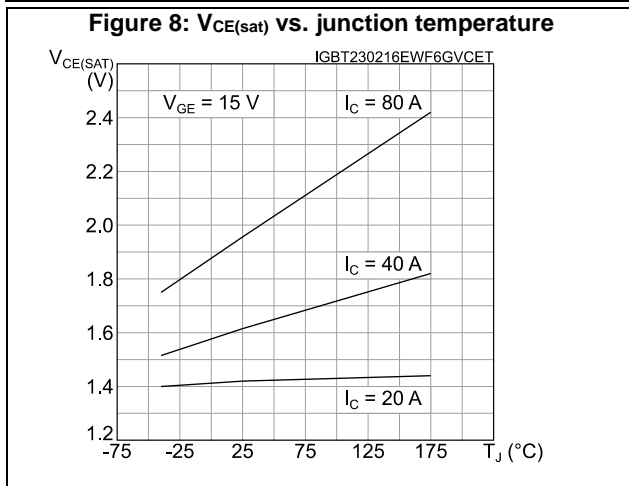
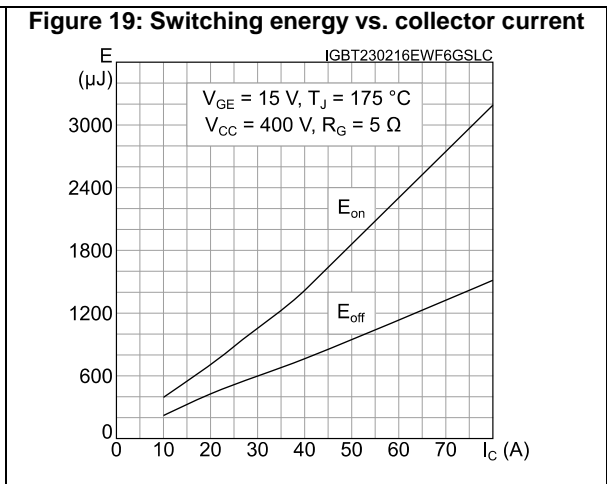
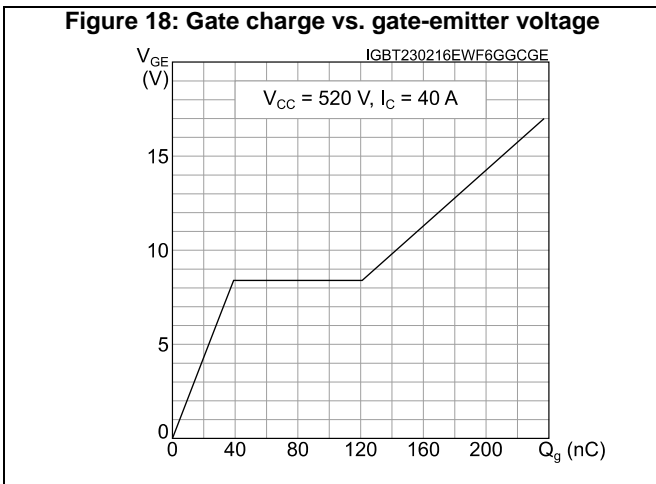
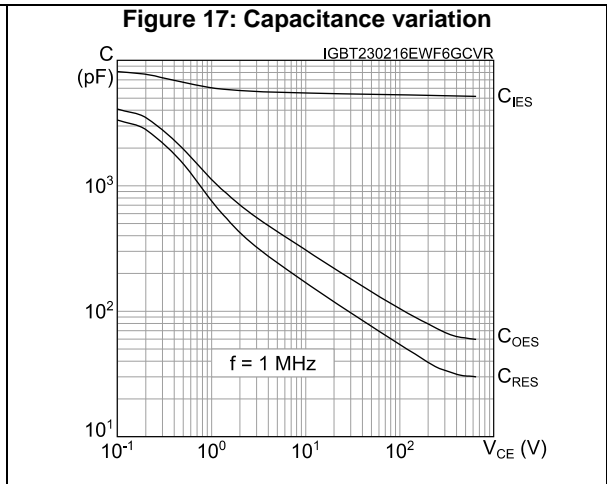
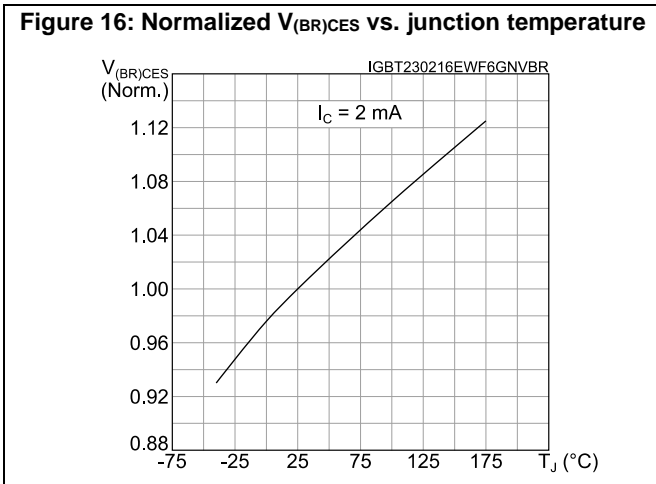
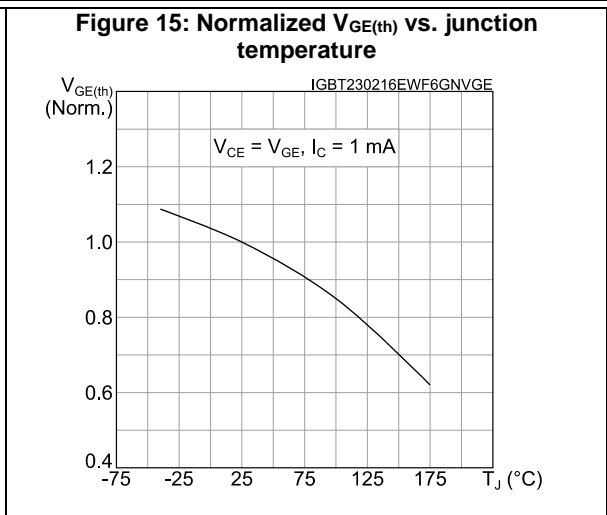
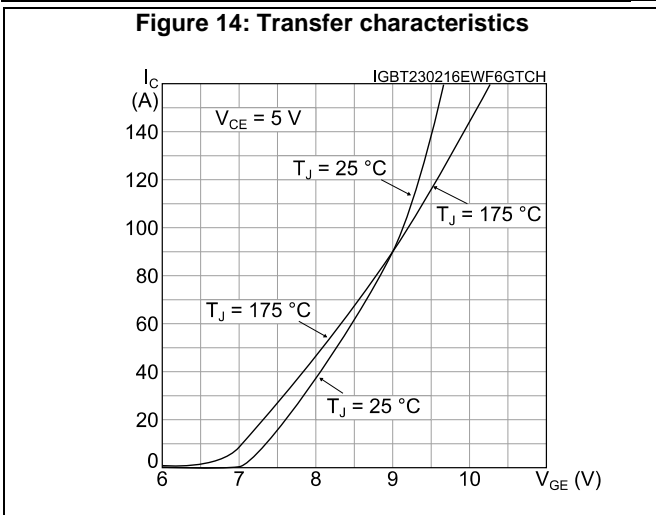

Figure 7: Output characteristics (T_J = 175 °C)







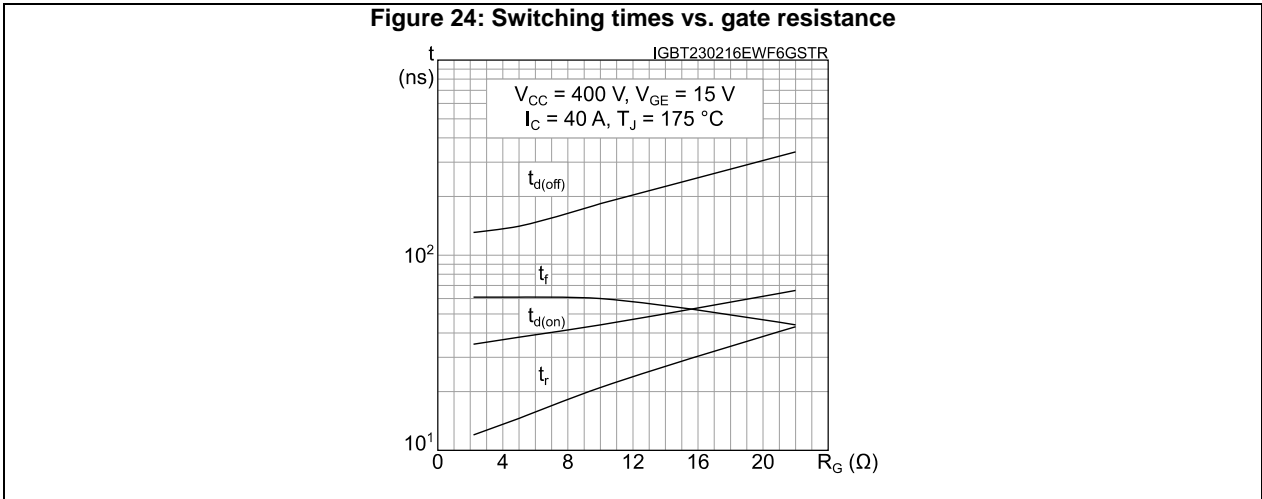
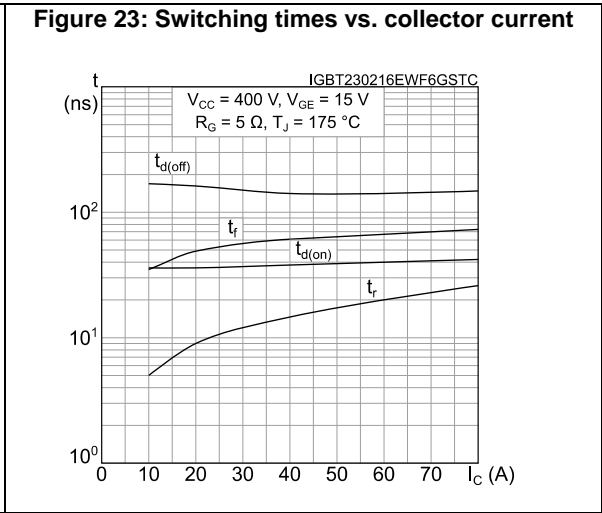
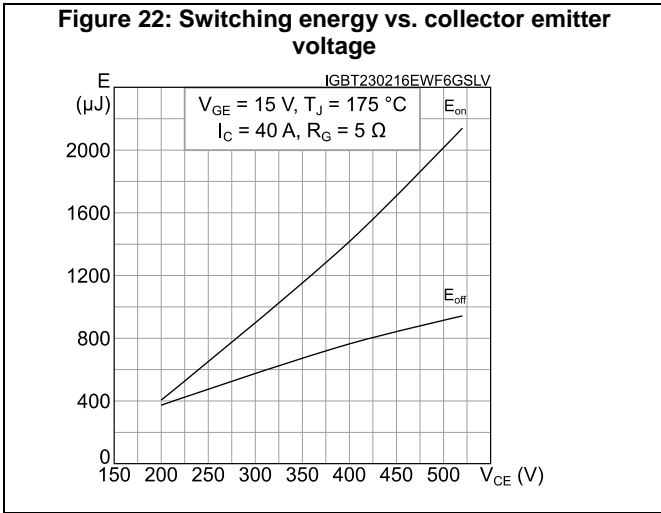
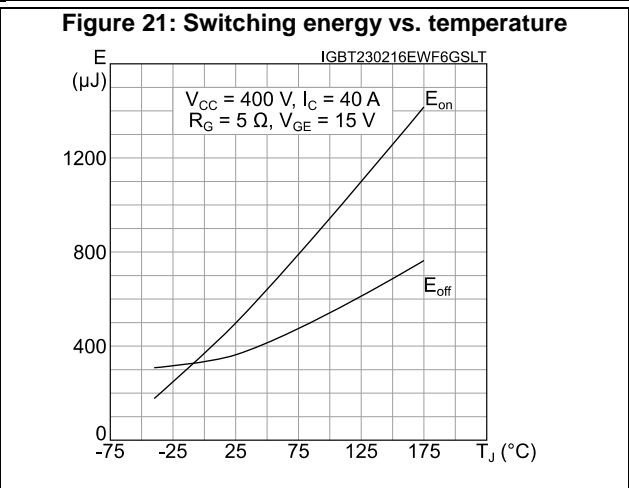
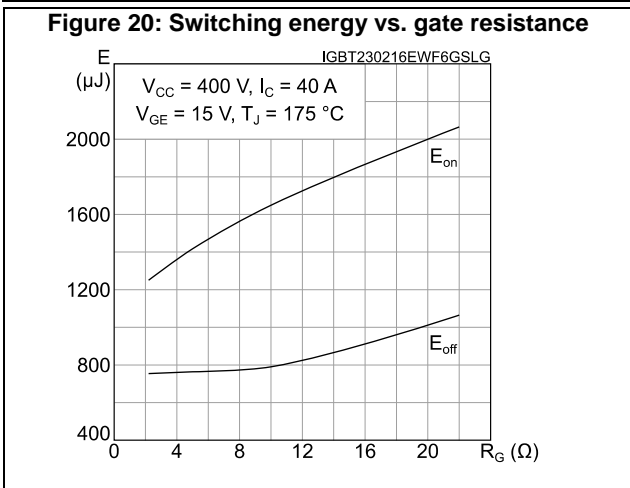

Figure 25: Thermal impedance for TO-247, TO-247 long leads and TO-3P

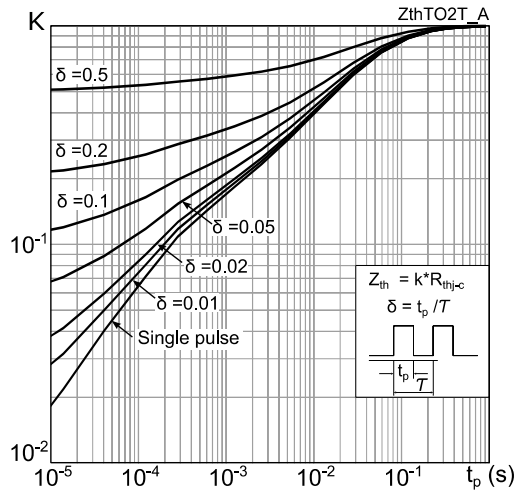
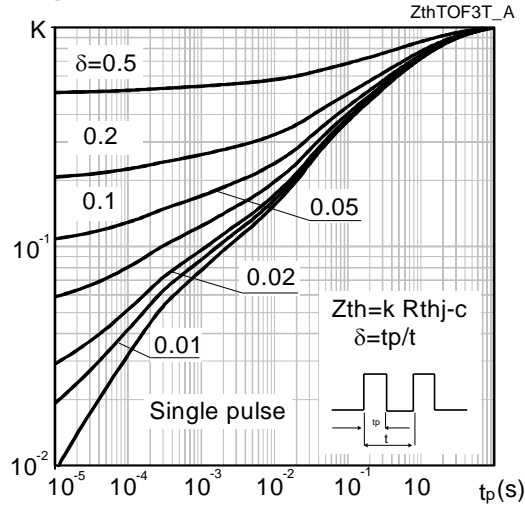
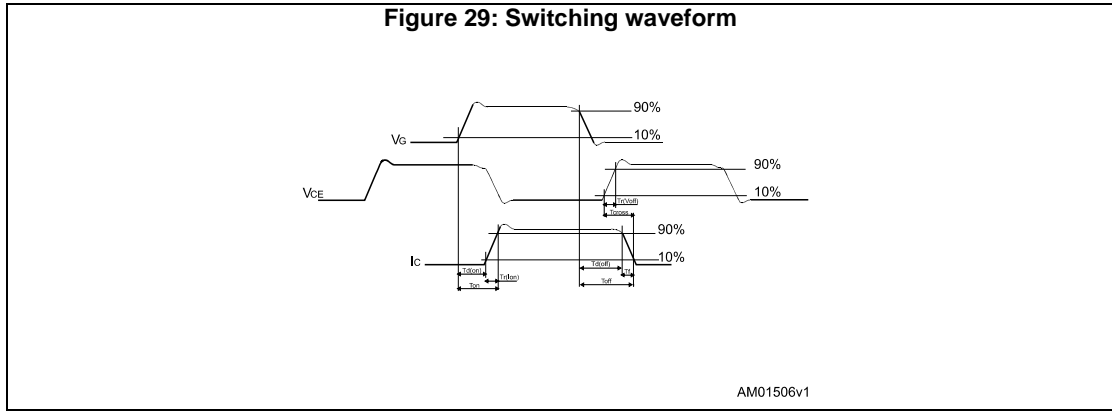
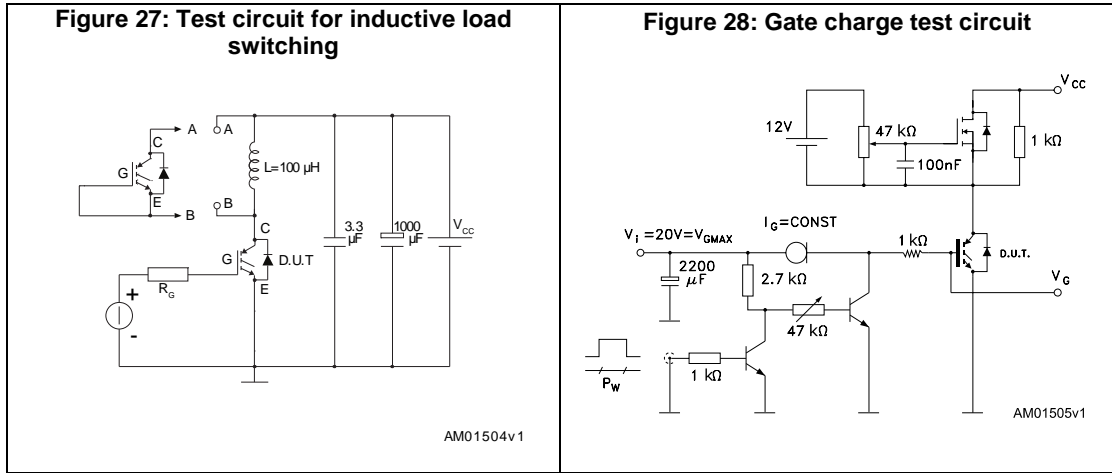

Figure 26: Thermal impedance for TO-3PF



3 Test circuits



4 Package information

In order to meet environmental requirements, ST offers these devices in different grades of ECOPACK® packages, depending on their level of environmental compliance. ECOPACK® specifications, grade definitions and product status are available at: www.st.com. ECOPACK® is an ST trademark.

4.1 TO-3PF package information

Figure 30: TO-3PF package outline

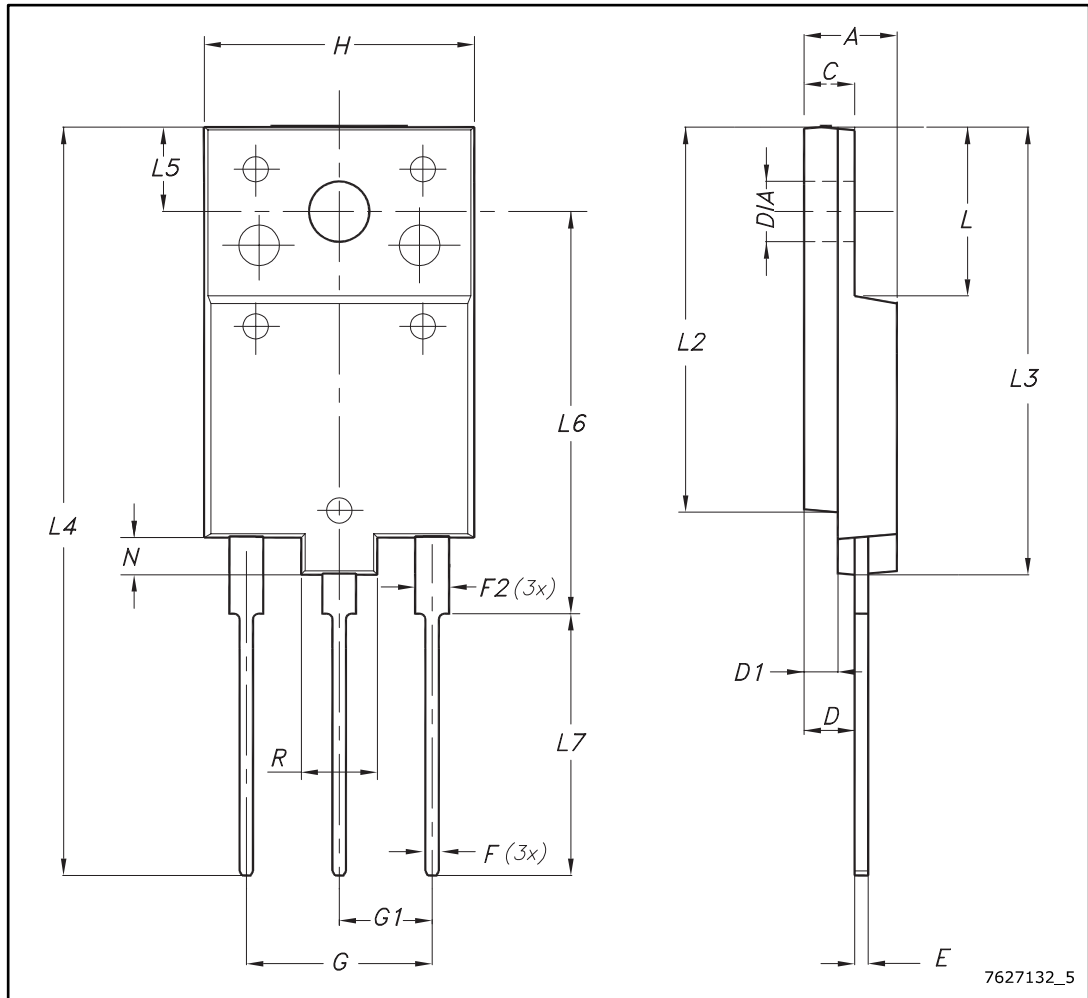

Table 7: TO-3PF mechanical data

Dim.	mm		
	Min.	Typ.	Max.
A	5.30		5.70
C	2.80		3.20
D	3.10		3.50
D1	1.80		2.20
E	0.80		1.10
F	0.65		0.95
F2	1.80		2.20
G	10.30		11.50
G1		5.45	
H	15.30		15.70
L	9.80	10	10.20
L2	22.80		23.20
L3	26.30		26.70
L4	43.20		44.40
L5	4.30		4.70
L6	24.30		24.70
L7	14.60		15
N	1.80		2.20
R	3.80		4.20
Dia	3.40		3.80

4.2 TO-247 package information

Figure 31: TO-247 package outline

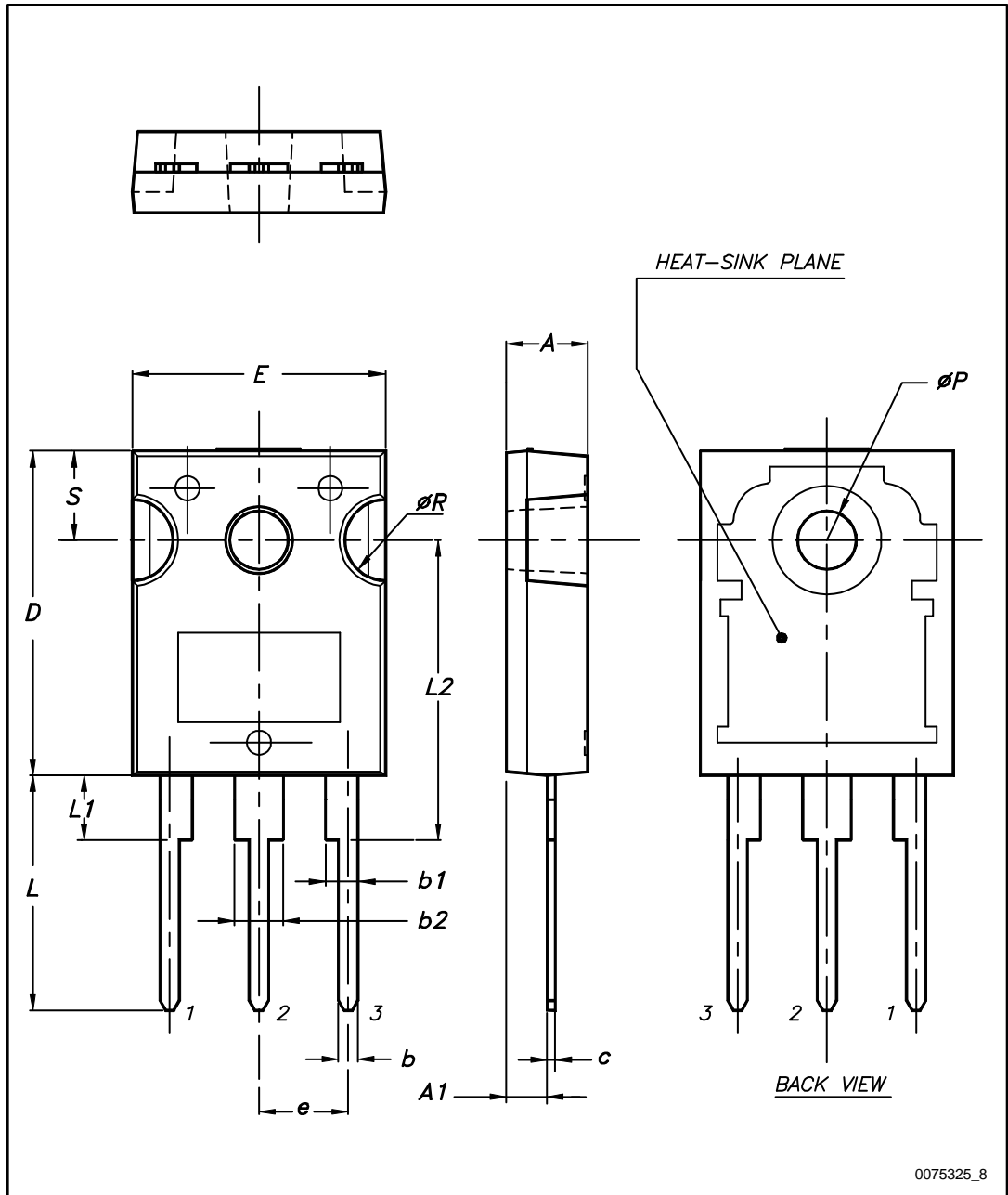
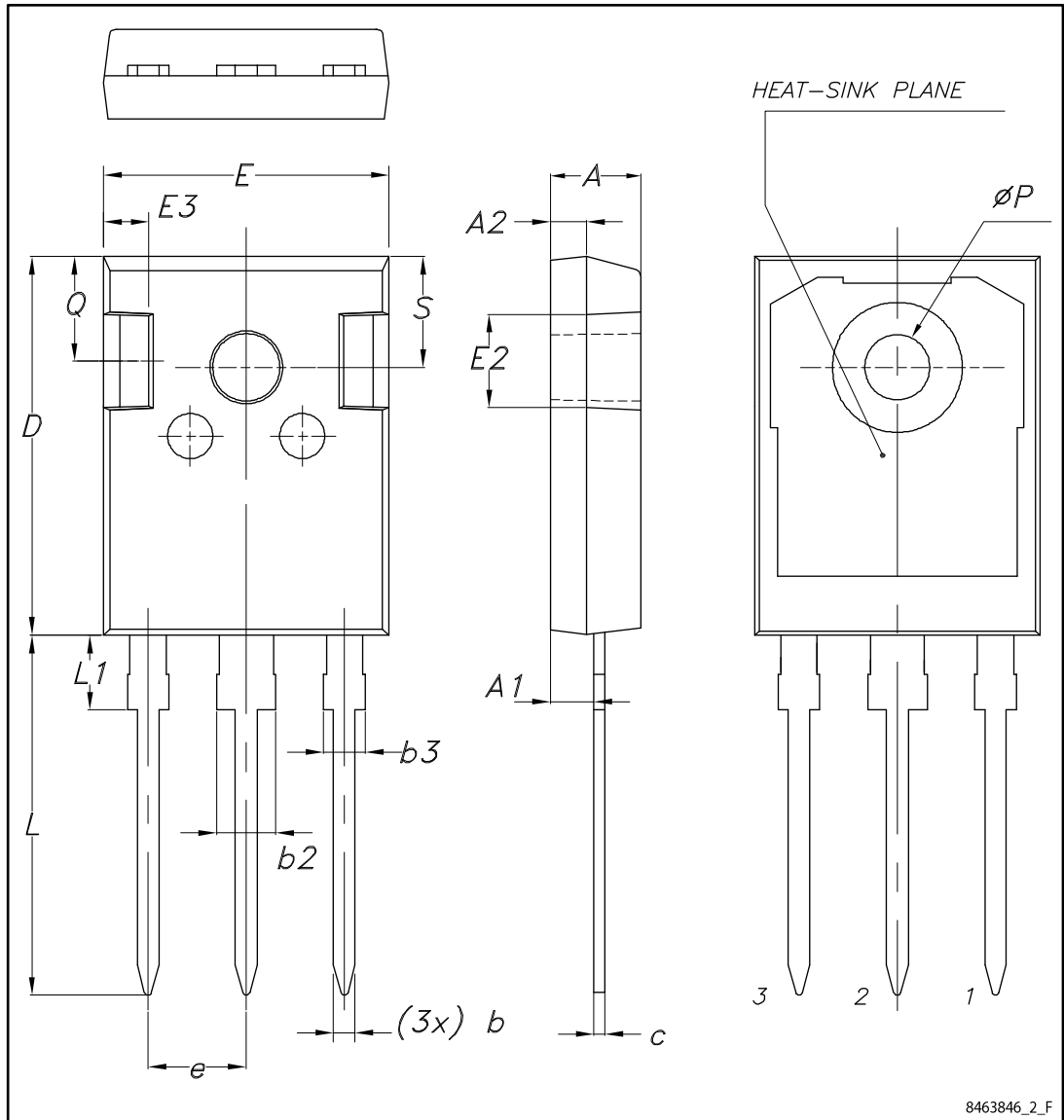

Table 8: TO-247 package mechanical data

Dim.	mm		
	Min.	Typ.	Max.
A	4.85		5.15
A1	2.20		2.60
b	1.0		1.40
b1	2.0		2.40
b2	3.0		3.40
c	0.40		0.80
D	19.85		20.15
E	15.45		15.75
e	5.30	5.45	5.60
L	14.20		14.80
L1	3.70		4.30
L2		18.50	
ØP	3.55		3.65
ØR	4.50		5.50
S	5.30	5.50	5.70

4.3 TO-247 long leads package information

Figure 32: TO-247 long leads package outline



8463846_2_F

Table 9: TO-247 long leads package mechanical data

Dim.	mm		
	Min.	Typ.	Max.
A	4.90	5.00	5.10
A1	2.31	2.41	2.51
A2	1.90	2.00	2.10
b	1.16		1.26
b2			3.25
b3			2.25
c	0.59		0.66
D	20.90	21.00	21.10
E	15.70	15.80	15.90
E2	4.90	5.00	5.10
E3	2.40	2.50	2.60
e	5.34	5.44	5.54
L	19.80	19.92	20.10
L1			4.30
P	3.50	3.60	3.70
Q	5.60		6.00
S	6.05	6.15	6.25

4.4 TO-3P package information

Figure 33: TO-3P package outline



Table 10: TO-3P package mechanical data

Dim.	mm		
	Min.	Typ.	Max.
A	4.60	4.80	5.00
A1	1.45	1.50	1.65
A2	1.20	1.40	1.60
b	0.80	1.00	1.20
b1	1.80	2.00	2.20
b2	2.80	3.00	3.20
c	0.55	0.60	0.75
D	19.70	19.90	20.10
D1	13.70	13.90	14.10
E	15.40	15.60	15.80
E1	13.40	13.60	13.80
E2	9.40	9.60	9.90
e	5.15	5.45	5.75
L	19.80	20.00	20.20
L1	3.30	3.50	3.70
L2	18.20	18.40	18.60
ØP	3.30	3.40	3.50
ØP1	3.10	3.20	3.30
Q	4.80	5.00	5.20
Q1	3.60	3.80	4

5 Revision history

Table 11: Document revision history

Date	Revision	Changes
30-Aug-2013	1	Initial release
11-Sep-2013	2	Document status changed from preliminary to production data. Inserted <i>Section 2.1: Electrical characteristics (curves)</i> .
28-Feb-2014	3	Updated title and description in cover page.
05-Mar-2014	4	Updated units in <i>Table 6: Switching characteristics (inductive load)</i> .
11-Apr-2014	5	Added part number and references for the device in a TO-3PF package.
03-Nov-2016	6	Added device in TO-247 long leads and updated the document accordingly. Updated <i>Section 2.1: Electrical characteristics (curves)</i> and <i>Section 4.3: TO-247 long leads, package information</i> . Minor text changes.
21-Mar-2017	7	Updated <i>Table 1: "Device summary"</i> . Added <i>Figure 26: "Thermal impedance for TO-3PF"</i> . Minor text changes

IMPORTANT NOTICE – PLEASE READ CAREFULLY

STMicroelectronics NV and its subsidiaries (“ST”) reserve the right to make changes, corrections, enhancements, modifications, and improvements to ST products and/or to this document at any time without notice. Purchasers should obtain the latest relevant information on ST products before placing orders. ST products are sold pursuant to ST’s terms and conditions of sale in place at the time of order acknowledgement.

Purchasers are solely responsible for the choice, selection, and use of ST products and ST assumes no liability for application assistance or the design of Purchasers’ products.

No license, express or implied, to any intellectual property right is granted by ST herein.

Resale of ST products with provisions different from the information set forth herein shall void any warranty granted by ST for such product.

ST and the ST logo are trademarks of ST. All other product or service names are the property of their respective owners.

Information in this document supersedes and replaces information previously supplied in any prior versions of this document.

© 2017 STMicroelectronics – All rights reserved

Компания «Life Electronics» занимается поставками электронных компонентов импортного и отечественного производства от производителей и со складов крупных дистрибьюторов Европы, Америки и Азии.

С конца 2013 года компания активно расширяет линейку поставок компонентов по направлению коаксиальный кабель, кварцевые генераторы и конденсаторы (керамические, пленочные, электролитические), за счёт заключения дистрибьюторских договоров

Мы предлагаем:

- Конкурентоспособные цены и скидки постоянным клиентам.
- Специальные условия для постоянных клиентов.
- Подбор аналогов.
- Поставку компонентов в любых объемах, удовлетворяющих вашим потребностям.
- Приемлемые сроки поставки, возможна ускоренная поставка.
- Доставку товара в любую точку России и стран СНГ.
- Комплексную поставку.
- Работу по проектам и поставку образцов.
- Формирование склада под заказчика.
- Сертификаты соответствия на поставляемую продукцию (по желанию клиента).
- Тестирование поставляемой продукции.
- Поставку компонентов, требующих военную и космическую приемку.
- Входной контроль качества.
- Наличие сертификата ISO.

В составе нашей компании организован Конструкторский отдел, призванный помогать разработчикам, и инженерам.

Конструкторский отдел помогает осуществить:

- Регистрацию проекта у производителя компонентов.
- Техническую поддержку проекта.
- Защиту от снятия компонента с производства.
- Оценку стоимости проекта по компонентам.
- Изготовление тестовой платы монтаж и пусконаладочные работы.



Тел: +7 (812) 336 43 04 (многоканальный)

Email: org@lifeelectronics.ru