



**Photocoupler**  
**Product Data Sheet**  
LTV-2X7 series

Spec No. :DS70-2009-0016  
Effective Date: 07/25/2018  
Revision: E

**LITE-ON DCC**

**RELEASE**

**BNS-OD-FC001/A4**

## Photocoupler LTV-2X7 series

### 1. DESCRIPTION

#### 1.1 Features

- Current transfer ratio (CTR) : MIN. 50% at  $I_F = 5\text{mA}$ ,  $V_{CE} = 5\text{V}$
- High input-output isolation voltage. (Viso=3,750Vrms)
- Employs double transfer mold technology
- Safety approval:
  - UL 1577
  - VDE DIN EN60747-5-5 (VDE 0884-5)
  - CSA CA5A
  - FIMKO
- RoHS Compliance: All materials be used in device are followed EU RoHS directive (No.2002/95/EC, 2011/65/EU, and 2015/863).
- ESD pass HBM 8000V/MM2000V
- MSL class1
- Halogen Free

#### 1.2 Applications

- Hybrid substrates that require high density mounting.
- Programmable controllers
- System appliances, measuring instruments

## Photocoupler LTV-2X7 series

### 2. PACKAGE DIMENSIONS

#### 2.1 LTV-217

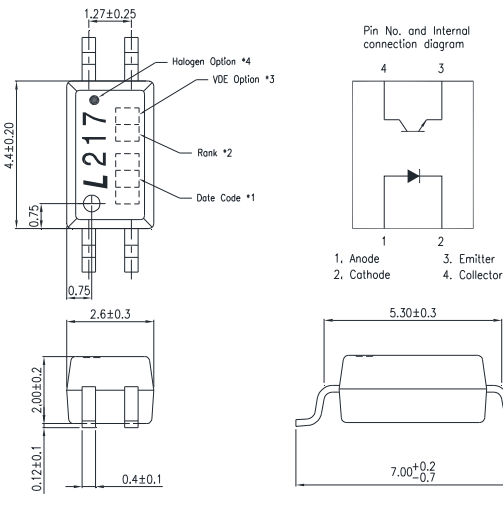

#### 2.2 LTV-227

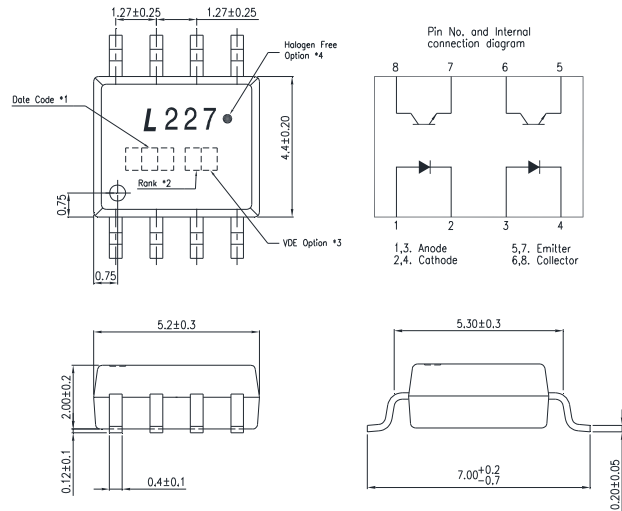

#### 2.3 LTV-247

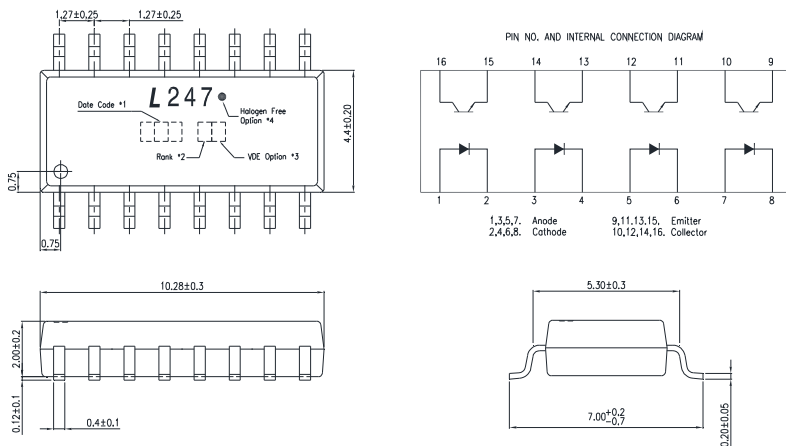

#### Notes :

- 1-digit year code, Example : 2010 = A  
2-digit work week ranging from '01' to '53'
- Rank shall be or shall not be marked
- VDE mark only appears on devices or ordered "V" option.
- "●" indicates Halogen free option.

\*All dimensions in millimeters.

## Photocoupler LTV-2X7 series

### 3. TAPING DIMENSIONS

#### 3.1 LTV-217

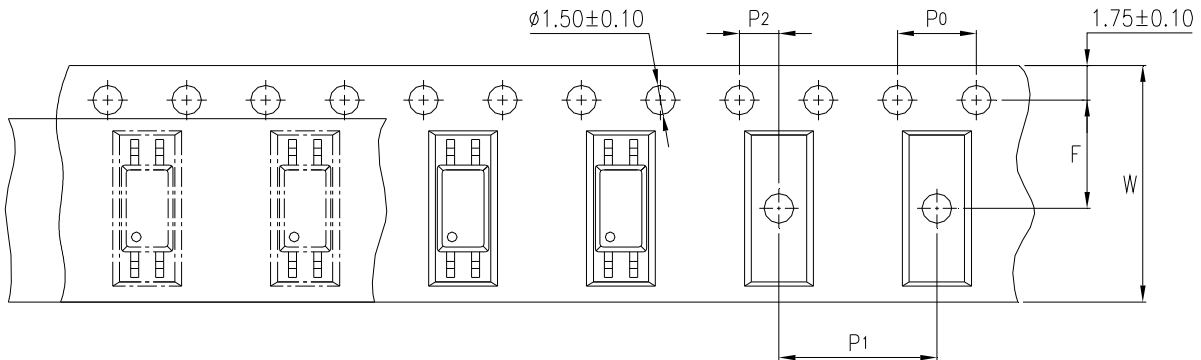

#### 3.2 LTV-217-TP1

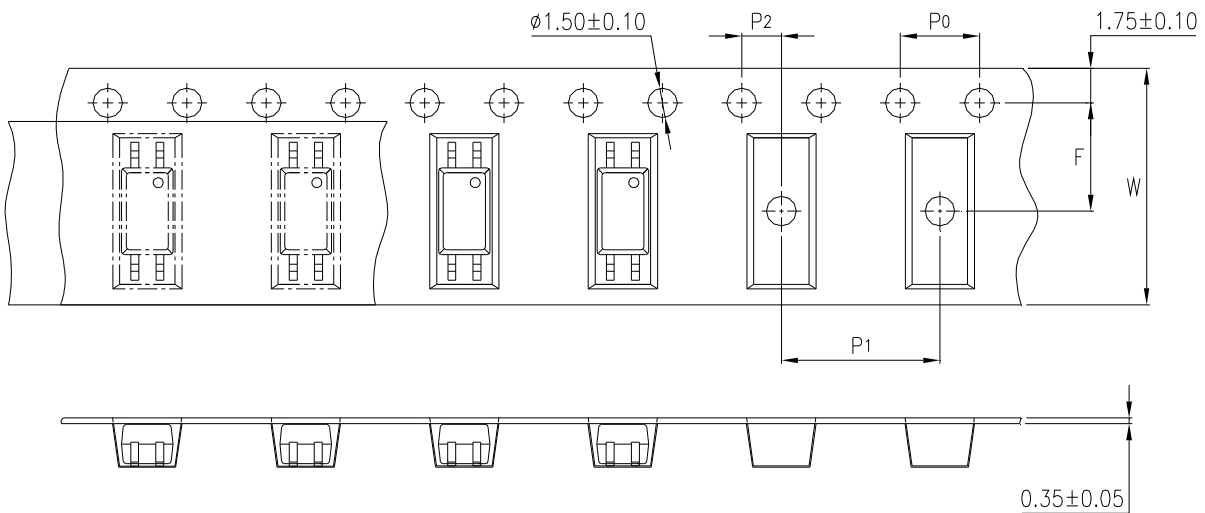

| Description                            | Symbol         | Dimension in mm (inch) |
|--|----------------|------------------------|
| Tape wide                              | W              | 12±0.3 (0.47)          |
| Pitch of sprocket holes                | P <sub>0</sub> | 4±0.1 (0.15)           |
| Distance of compartment                | F              | 5.5±0.1 (0.217)        |
|  | P <sub>2</sub> | 2±0.1 (0.079)          |
| Distance of compartment to compartment | P <sub>1</sub> | 8±0.1 (0.315)          |

## Photocoupler LTV-2X7 series

### 3.3 LTV-227

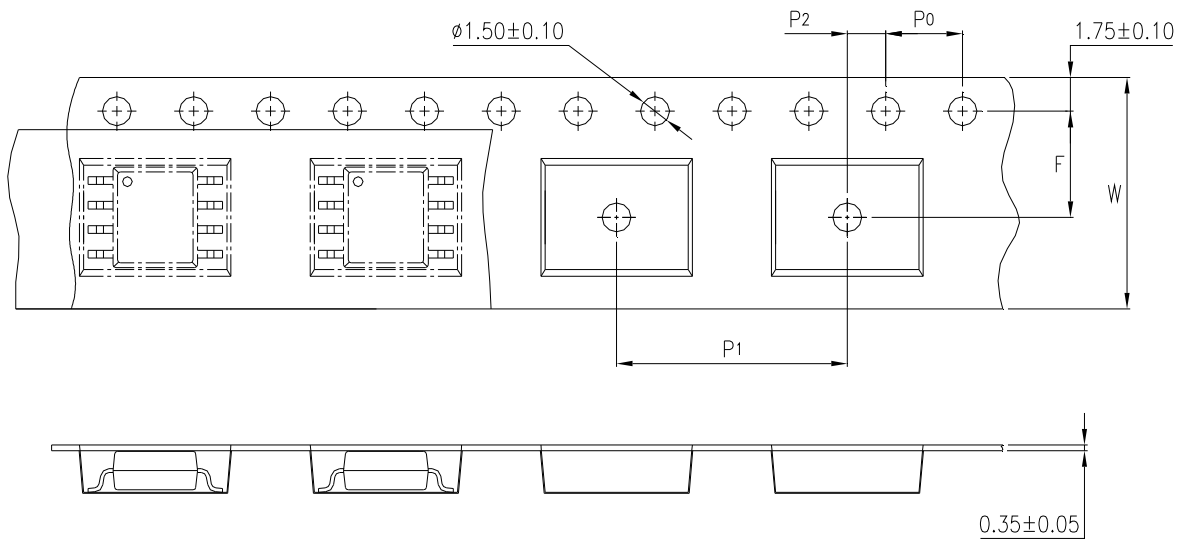

| Description                            | Symbol         | Dimension in mm (inch) |
|--|----------------|------------------------|
| Tape wide                              | W              | 12±0.3 (0.47)          |
| Pitch of sprocket holes                | P <sub>0</sub> | 4±0.1 (0.15)           |
| Distance of compartment                | F              | 5.5±0.1 (0.217)        |
|  | P <sub>2</sub> | 2±0.1 (0.079)          |
| Distance of compartment to compartment | P <sub>1</sub> | 8±0.1 (0.315)          |

## Photocoupler LTV-2X7 series

### 3.4 LTV-247

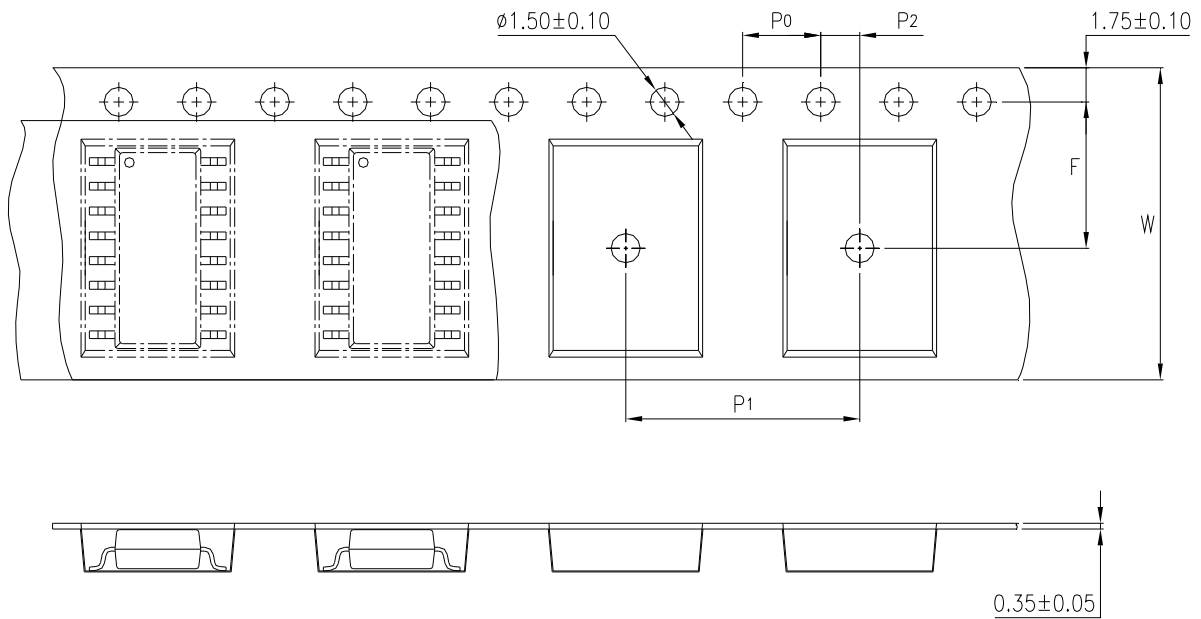

| Description                            | Symbol         | Dimension in mm (inch) |
|--|----------------|------------------------|
| Tape wide                              | W              | 16±0.3 (0.47)          |
| Pitch of sprocket holes                | P <sub>0</sub> | 4±0.1 (0.15)           |
| Distance of compartment                | F              | 7.5±0.1 (0.217)        |
|  | P <sub>2</sub> | 2±0.1 (0.079)          |
| Distance of compartment to compartment | P <sub>1</sub> | 12±0.1 (0.315)         |

### 3.5 Quantities per Reel

| Package Type     | LTV-217 | LTV-227 | LTV-247 |
|------------------|---------|---------|---------|
| Quantities (pcs) | 3000    | 2000    | 2000    |

## Photocoupler LTV-2X7 series

### 4. RATING AND CHARACTERISTICS

#### 4.1 Absolute Maximum Ratings at Ta=25°C

|        | Parameter                   | Symbol    | Rating     |     |     | Unit      |
|--------|-----------------------------|-----------|------------|-----|-----|-----------|
|        |                             |           | 217        | 227 | 247 |           |
| Input  | Forward Current             | $I_F$     | 50         |     |     | mA        |
|        | Reverse Voltage             | $V_R$     | 6          |     |     | V         |
|        | Power Dissipation           | P         | 70         |     |     | mW        |
|        | Pulse Forward Current       | $I_{FSM}$ | 1          |     |     | A         |
|        | Junction Temperature        | $T_J$     | 125        |     |     | °C        |
| Output | Collector - Emitter Voltage | $V_{CEO}$ | 80         |     |     | V         |
|        | Emitter - Collector Voltage | $V_{ECO}$ | 7          |     |     | V         |
|        | Collector Current           | $I_C$     | 50         |     |     | mA        |
|        | Collector Power Dissipation | $P_C$     | 150        |     | 100 | mW        |
|        | Junction Temperature        | $T_J$     | 125        |     |     | °C        |
|        | Total Power Dissipation     | $P_{tot}$ | 200        |     | 170 | mW        |
| 1.     | Isolation Voltage           | $V_{iso}$ | 3750       |     |     | $V_{rms}$ |
|        | Operating Temperature       | $T_{opr}$ | -55 ~ +110 |     |     | °C        |
|        | Storage Temperature         | $T_{stg}$ | -55 ~ +150 |     |     | °C        |
| 2.     | Soldering Temperature       | $T_{sol}$ | 260        |     |     | °C        |

1. AC For 1 Minute, R.H. = 40 ~ 60%

Isolation voltage shall be measured using the following method.

- (1) Short between anode and cathode on the primary side and between collector and emitter on the secondary side.
- (2) The isolation voltage tester with zero-cross circuit shall be used.
- (3) The waveform of applied voltage shall be a sine wave.

2. For 10 Seconds

## Photocoupler LTV-2X7 series

### 4.2 ELECTRICAL OPTICAL CHARACTERISTICS at Ta=25°C

| Parameter                |                                      | Symb          | Min.               | Typ.               | Max. | Unit          | Test Condition   |
|--------------------------|--------------------------------------|---------------|--------------------|--------------------|------|---------------|--|
| Input                    | Forward Voltage                      | $V_F$         | —                  | 1.2                | 1.4  | V             | $I_F=20\text{mA}$  |
|                          | Reverse Current                      | $I_R$         | —                  | —                  | 10   | $\mu\text{A}$ | $V_R=4\text{V}$  |
|                          | Terminal Capacitance                 | $C_t$         | —                  | 30                 | 250  | pF            | $V=0, f=1\text{KHz}$   |
| Output                   | Collector Dark Current               | $I_{CEO}$     | —                  | —                  | 100  | nA            | $V_{CE}=20\text{V}, I_F=0$                                     |
|                          | Collector-Emitter Breakdown Voltage  | $BV_{CEO}$    | 80                 | —                  | —    | V             | $I_C=0.1\text{mA}, I_F=0$                                      |
|                          | Emitter-Collector Breakdown Voltage  | $BV_{ECO}$    | 7                  | —                  | —    | V             | $I_E=10\mu\text{A}, I_F=0$                                     |
| TRANSFER CHARACTERISTICS | Collector Current                    | $I_C$         | 2.5                | —                  | 30   | mA            | $I_F=5\text{mA}$   |
|                          | 1. Current Transfer Ratio            | CTR           | 50                 | —                  | 600  | %             | $V_{CE}=5\text{V}$   |
|                          | Collector-Emitter Saturation Voltage | $V_{CE(sat)}$ | —                  | —                  | 0.4  | V             | $I_F=8\text{mA}$<br>$I_C=2.4\text{mA}$                         |
|                          | Isolation Resistance                 | $R_{iso}$     | $5 \times 10^{10}$ | $1 \times 10^{11}$ | —    | $\Omega$      | DC500V,<br>40 ~ 60% R.H.                                       |
|                          | Floating Capacitance                 | $C_f$         | —                  | 0.6                | 1    | pF            | $V=0, f=1\text{MHz}$   |
|                          | Response Time (Rise)                 | $t_r$         | —                  | 2                  | 18   | $\mu\text{s}$ | $V_{CC}=10\text{V},$   |
|                          | Response Time (Fall)                 | $t_f$         | —                  | 3                  | 18   | $\mu\text{s}$ | $I_C=2\text{mA}$   |
|                          | Turn-On Time                         | $T_{ON}$      | —                  | 3                  | —    | $\mu\text{s}$ | $R_L=100\Omega,$   |
|                          | Turn-Off Time                        | $T_{OFF}$     | —                  | 3                  | —    | $\mu\text{s}$ | $f=100\text{Hz}$   |
|                          | Turn-On Time                         | $t_{ON}$      | —                  | 2                  | —    | $\mu\text{s}$ | $V_{CC}=5\text{V}, I_F=16\text{mA}$<br>$R_L=1.9\text{K}\Omega$ |
|                          | Storage Time                         | $T_s$         | —                  | 25                 | —    | $\mu\text{s}$ |  |
|                          | Turn-Off Time                        | $t_{OFF}$     | —                  | 40                 | —    | $\mu\text{s}$ |  |

$$1. \text{CTR} = \frac{I_C}{I_F} \times 100\%$$



## Photocoupler LTV-2X7 series

### 5. RANK TABLE OF CURRENT TRANSFER RATIO CTR

| MODEL NO. | CTR Rank                    | Min | Max | Condition                             |
|-----------|-----------------------------|-----|-----|---------------------------------------|
| LTV-217   | A                           | 80  | 160 | $I_F=5mA, V_{CE}=5V, T_a=25^{\circ}C$ |
|           | A1                          | 100 | 160 |                                       |
|           | B                           | 130 | 260 |                                       |
|           | C                           | 200 | 400 |                                       |
|           | D                           | 300 | 600 |                                       |
|           | A or B or C or D or No mark | 50  | 600 |                                       |
| LTV-227   | B                           | 130 | 260 |                                       |
|           | C                           | 200 | 400 |                                       |
|           | B or C or No mark           | 50  | 600 |                                       |
| LTV-247   | No mark                     | 100 | 600 |                                       |

## Photocoupler LTV-2X7 series

### 6. CHARACTERISTICS CURVES (TYPICAL PERFORMANCE)

Figure 1. Collector Power Dissipation vs. Ambient Temperature

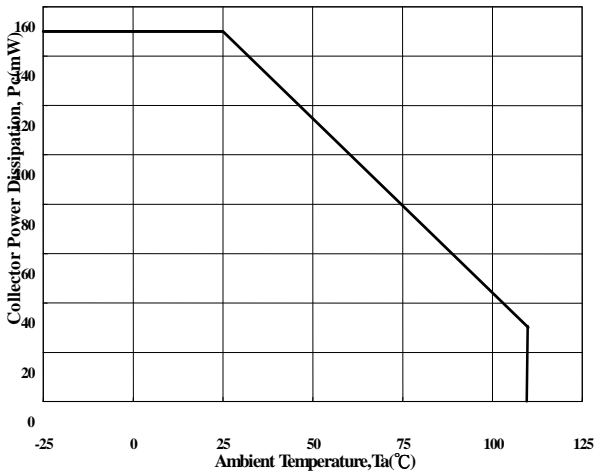

Figure 2. Forward Current vs. Ambient Temperature

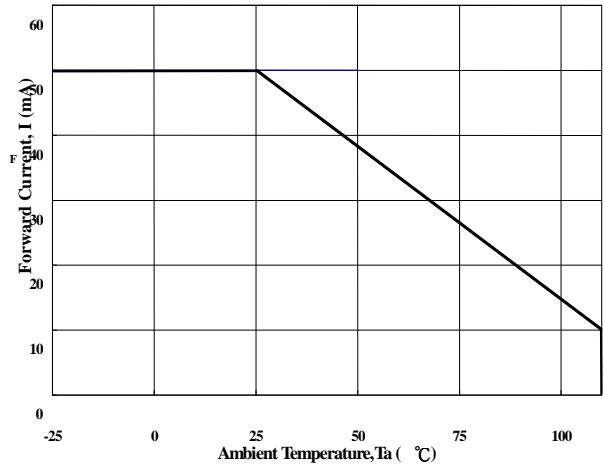

Figure 3. Forward Current vs. Forward Voltage

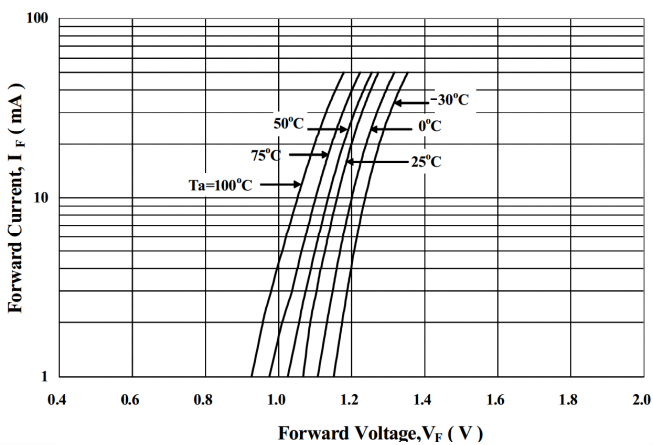

Figure 4. Forward Voltage Temperature Coefficient vs. Forward Current

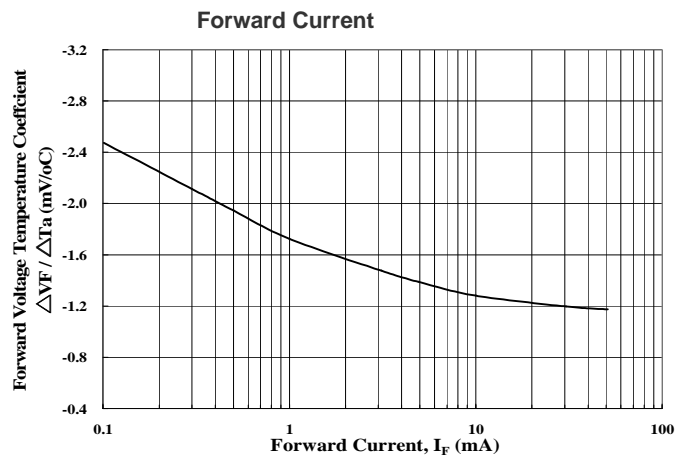

Figure 5. Pulse Forward Current vs. Duty Cycle Ratio

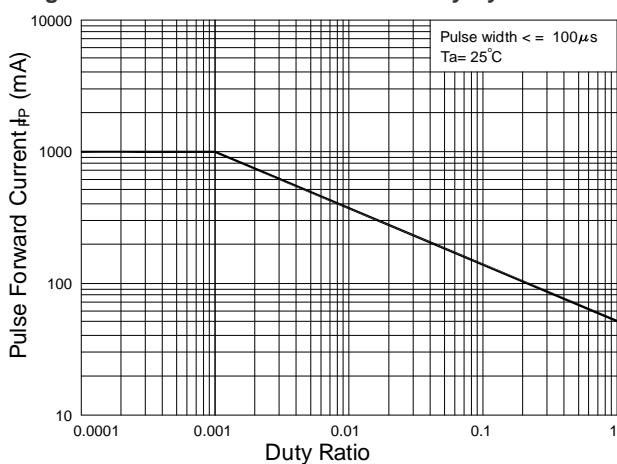
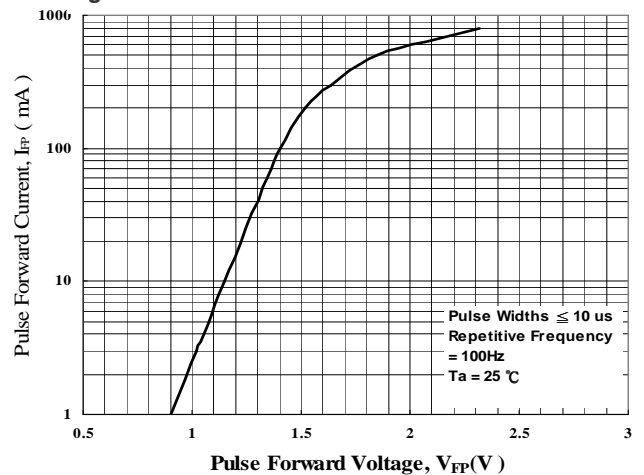

Figure 6. Pulse Forward Current vs. Pulse Forward Voltage



## Photocoupler LTV-2X7 series

Figure 7. Collector-Emitter Saturation Voltage vs. Forward Current

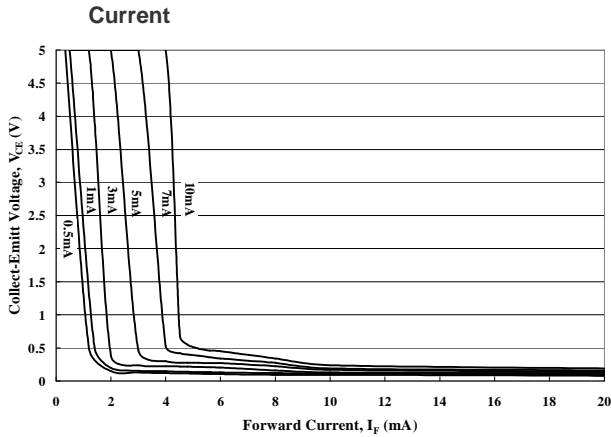

Figure 8. Collector Current vs. Collector-Emitter Voltage

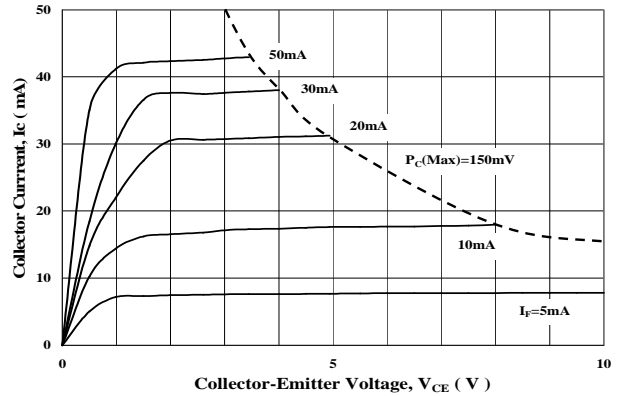

Figure 9. Collector Current vs. Small Collector-Emitter Voltage

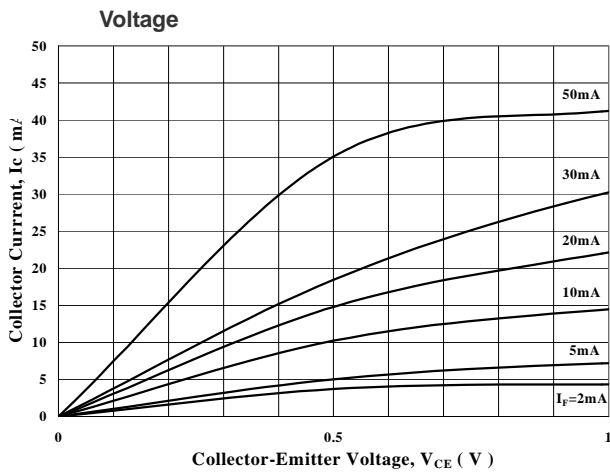

Figure 10. Normalized CTR vs. Forward Current

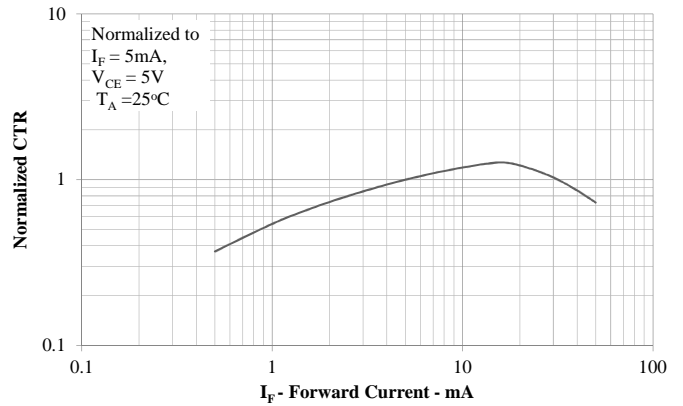

Figure 11. Collector Dark Current vs. Ambient Temperature

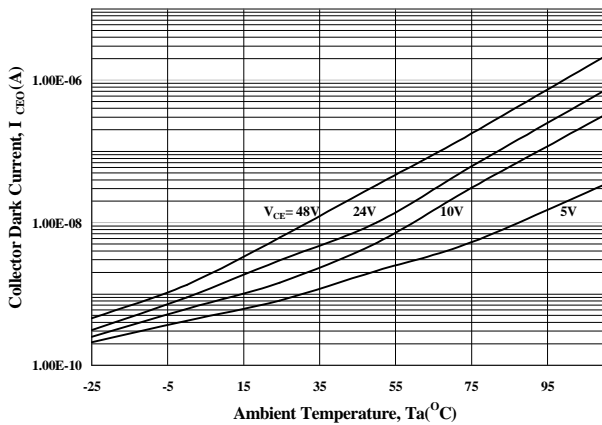
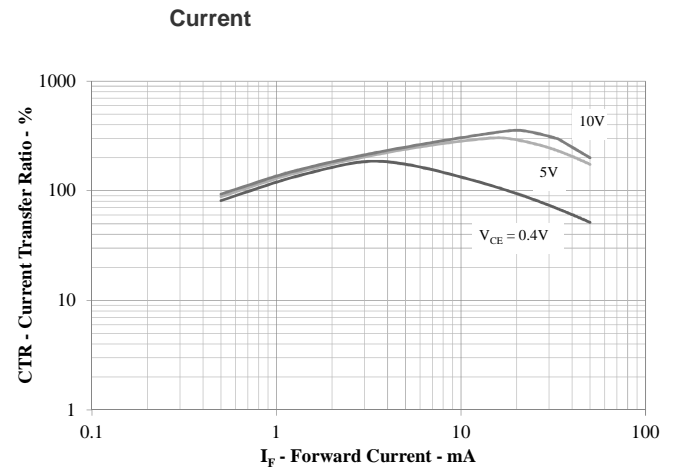

Figure 12. Current Transfer Ratio vs. Forward Current



## Photocoupler LTV-2X7 series

Figure 13. Normalized CTR vs. Ambient Temperature

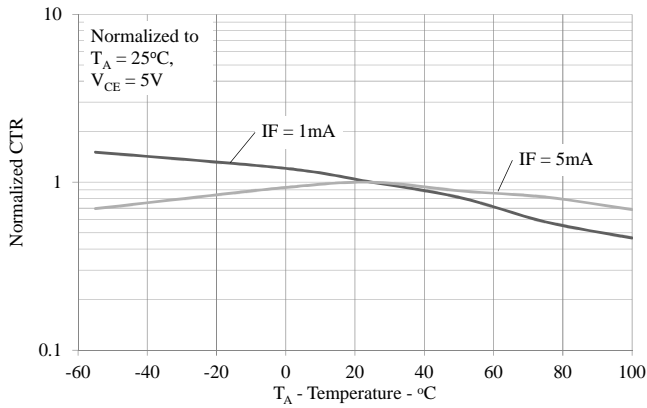

Figure 15. Collector Current vs. Ambient Temperature

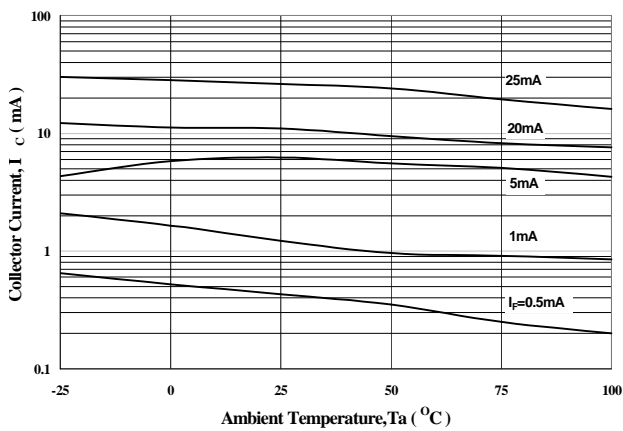

Figure 17. Switching Time vs. Ambient Temperature

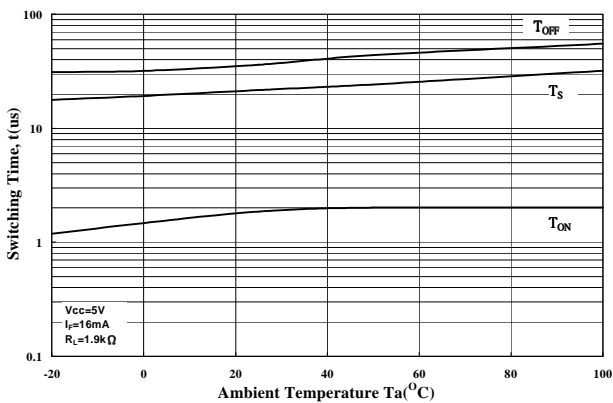

Figure 14. Collector-Emitter Saturation Voltage vs. Ambient Temperature

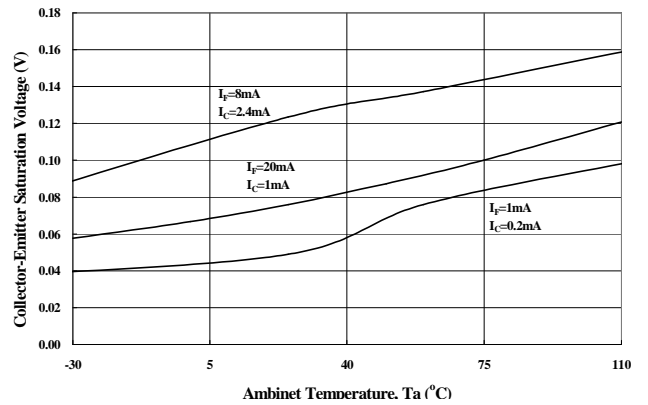

Figure 16. Switching Time vs. Load Resistance

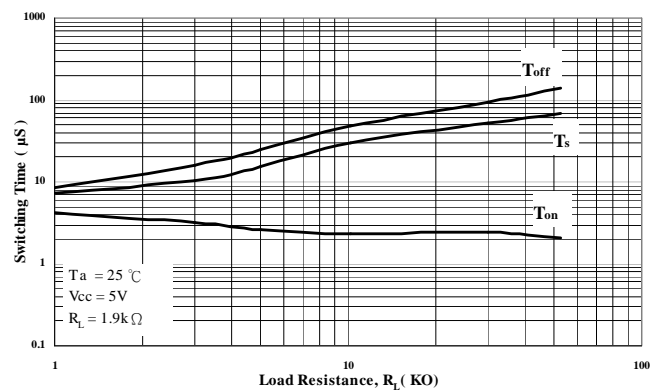
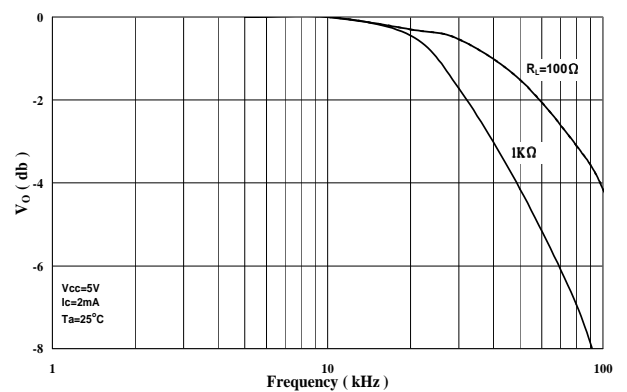
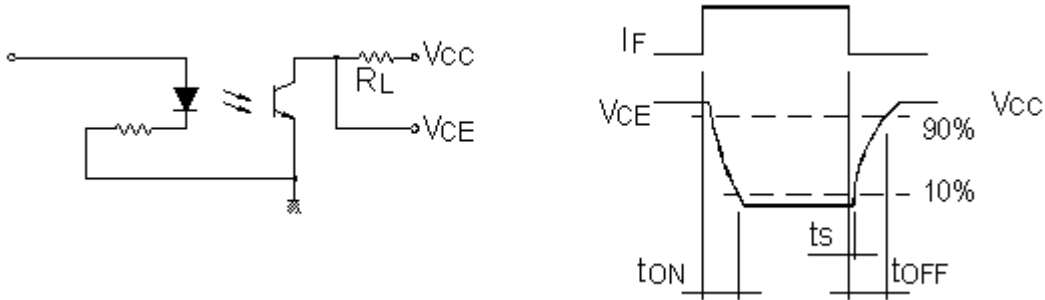

Figure 18. Frequency Response



## Photocoupler LTV-2X7 series

### 7. SWITCHING TIME TEST CIRCUIT



### 8. TEMPERATURE PROFILE OF SOLDERING

#### 8.1 IR Reflow soldering (JEDEC-STD-020C compliant)

One time soldering reflow is recommended within the condition of temperature and time profile shown below. Do not solder more than three times.

| Profile item                     | Conditions     |
|----------------------------------|----------------|
| Preheat                          |                |
| - Temperature Min ( $T_{Smin}$ ) | 150°C          |
| - Temperature Max ( $T_{Smax}$ ) | 200°C          |
| - Time (min to max) (ts)         | 90±30 sec      |
| Soldering zone                   |                |
| - Temperature ( $T_L$ )          | 217°C          |
| - Time ( $t_L$ )                 | 60 ~100 sec    |
| Peak Temperature ( $T_P$ )       | 260°C          |
| Ramp-up rate                     | 3°C / sec max. |
| Ramp-down rate                   | 3-6°C / sec    |

Photocoupler  
LTV-2X7 series

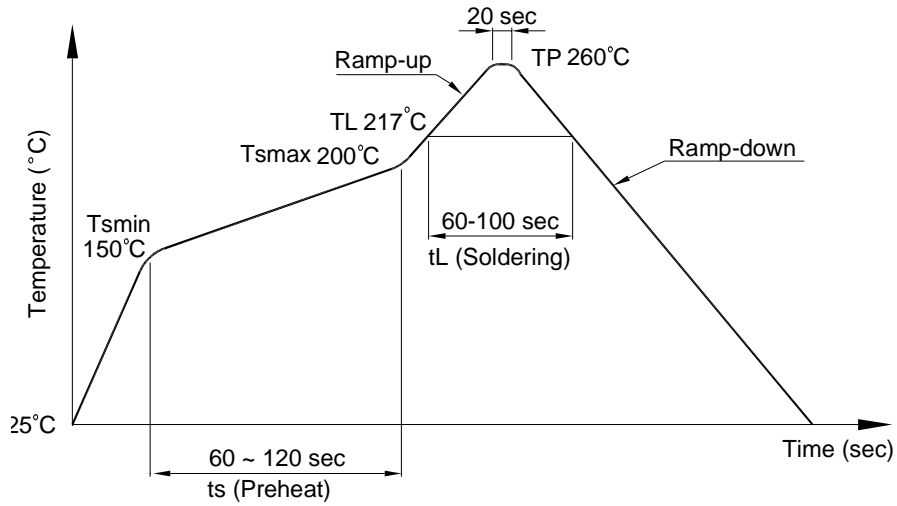

8.2 Wave soldering (JEDEC22A111 compliant)

One time soldering is recommended within the condition of temperature.

Temperature: 260+0/-5°C

Time: 10 sec.

Preheat temperature: 25 to 140°C

Preheat time: 30 to 80 sec.

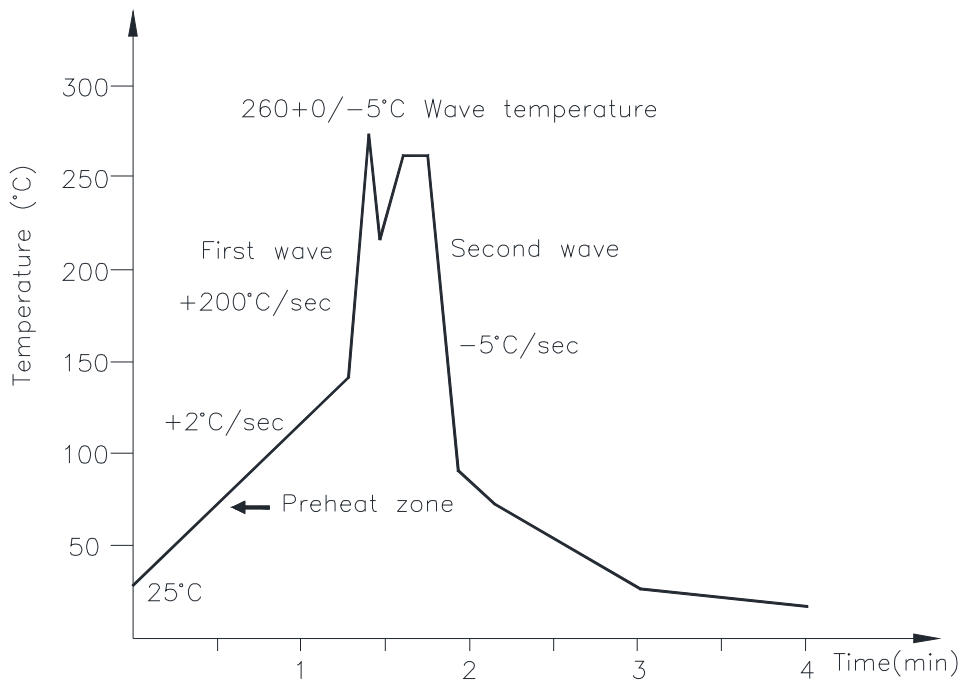

**Photocoupler  
LTV-2X7 series**

**8.3 Hand soldering by soldering iron**

Allow single lead soldering in every single process. One time soldering is recommended.

Temperature: 380+0/-5°C

Time: 3 sec max.

**9. RECOMMENDED FOOT PRINT PATTERNS (MOUNT PAD)**

Unit: mm

**9.1 LTV-217**

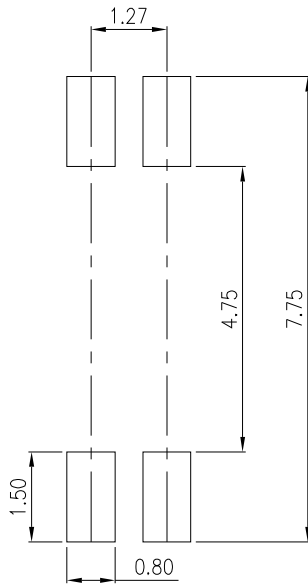

**9.2 LTV-227**

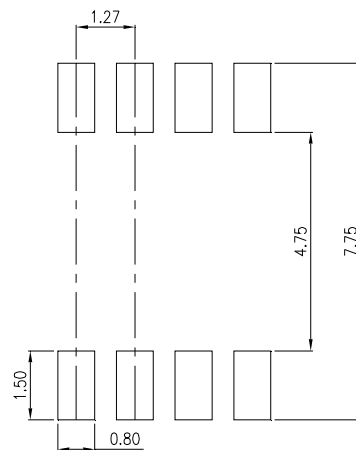

**9.3 LTV-247**

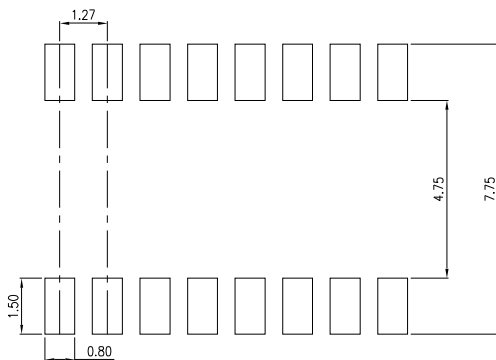

**Photocoupler  
LTV-2X7 series**

**10. NAMING RULE**

**LTV-2X7-(1)-(2)-G**

DEVICE PART NUMBER

(1) TAPING TYPE (TP1 or no suffix)

Please refer to orientation of taping on Page P3-P5

(2) CTR RANK

Please refer to the CTR table on Page P8

(3) Halogen free option

Example : LTV-217-TP1-A-G

**LTV2X7(1)(2)-V-G**

DEVICE PART NUMBER

(1) TAPING TYPE (TP1 or no suffix)

Please refer to orientation of taping on Page P3-P5

(2) CTR RANK

Please refer to the CTR table on Page P8

(3) VDE order option

(4) Halogen free option

Example : LTV217TP1A-V-G

**11. NOTES**

- LiteOn is continually improving the quality, reliability, function or design and LiteOn reserves the right to make changes without further notices.
- The products shown in this publication are designed for the general use in electronic applications such as office automation equipment, communications devices, audio/visual equipment, electrical application and instrumentation.
- For equipment/devices where high reliability or safety is required, such as space applications, nuclear power control equipment, medical equipment, etc, please contact our sales representatives.
- When requiring a device for any "specific" application, please contact our sales in advance.
- If there are any questions about the contents of this publication, please contact us at your convenience.
- The contents described herein are subject to change without prior notice.
- Immerge unit's body in solder paste is not recommended.



# Mouser Electronics

Authorized Distributor

Click to View Pricing, Inventory, Delivery & Lifecycle Information:

[Lite-On:](#)

[LTV-247](#) [LTV-217-TP1-B-G](#) [LTV-217-C-G](#) [LTV-217-B-G](#) [LTV-217-G](#) [LTV-217-A-G](#) [LTV-217-A-V-G](#) [LTV-217-TP1-C-G](#)

Компания «Life Electronics» занимается поставками электронных компонентов импортного и отечественного производства от производителей и со складов крупных дистрибьюторов Европы, Америки и Азии.

С конца 2013 года компания активно расширяет линейку поставок компонентов по направлению коаксиальный кабель, кварцевые генераторы и конденсаторы (керамические, пленочные, электролитические), за счёт заключения дистрибьюторских договоров

Мы предлагаем:

- Конкуренспособные цены и скидки постоянным клиентам.
- Специальные условия для постоянных клиентов.
- Подбор аналогов.
- Поставку компонентов в любых объемах, удовлетворяющих вашим потребностям.
- Приемлемые сроки поставки, возможна ускоренная поставка.
- Доставку товара в любую точку России и стран СНГ.
- Комплексную поставку.
- Работу по проектам и поставку образцов.
- Формирование склада под заказчика.
- Сертификаты соответствия на поставляемую продукцию (по желанию клиента).
- Тестирование поставляемой продукции.
- Поставку компонентов, требующих военную и космическую приемку.
- Входной контроль качества.
- Наличие сертификата ISO.

В составе нашей компании организован Конструкторский отдел, призванный помогать разработчикам, и инженерам.

Конструкторский отдел помогает осуществить:

- Регистрацию проекта у производителя компонентов.
- Техническую поддержку проекта.
- Защиту от снятия компонента с производства.
- Оценку стоимости проекта по компонентам.
- Изготовление тестовой платы монтаж и пусконаладочные работы.



Тел: +7 (812) 336 43 04 (многоканальный)  
Email: [org@lifeelectronics.ru](mailto:org@lifeelectronics.ru)