

BC846BPDW1T1G, SBC846BPDW1T1G, BC847BPDW1T1G, SBC847BPDW1T1G Series, BC848CPDW1T1G



ON Semiconductor®

<http://onsemi.com>



SOT-363
CASE 419B
STYLE 1

Dual General Purpose Transistors

NPN/PNP Duals (Complementary)

These transistors are designed for general purpose amplifier applications. They are housed in the SOT-363/SC-88 which is designed for low power surface mount applications.

Features

- AEC-Q101 Qualified and PPAP Capable
- S Prefix for Automotive and Other Applications Requiring Unique Site and Control Change Requirements
- These Devices are Pb-Free, Halogen Free/BFR Free and are RoHS Compliant*

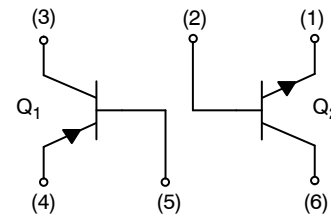

MARKING DIAGRAM

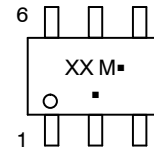

XX = Device Code
M = Date Code
▪ = Pb-Free Package

(Note: Microdot may be in either location)

MAXIMUM RATINGS – NPN

| Rating | Symbol | Value | Unit |
|--|-----------|----------------|------|
| Collector-Emitter Voltage BC846, SBC846 BC847, SBC847 BC848 | V_{CEO} | 65 45 30 | V |
| Collector-Base Voltage BC846, SBC846 BC847, SBC847 BC848 | V_{CBO} | 80 50 30 | V |
| Emitter-Base Voltage | V_{EBO} | 6.0 | V |
| Collector Current – Continuous | I_C | 100 | mAdc |

MAXIMUM RATINGS – PNP

| Rating | Symbol | Value | Unit |
|--|-----------|-------------------|------|
| Collector-Emitter Voltage BC846, SBC846 BC847, SBC847 BC848 | V_{CEO} | -65 -45 -30 | V |
| Collector-Base Voltage BC846, SBC846 BC847, SBC847 BC848 | V_{CBO} | -80 -50 -30 | V |
| Emitter-Base Voltage | V_{EBO} | -5.0 | V |
| Collector Current – Continuous | I_C | -100 | mAdc |

Stresses exceeding Maximum Ratings may damage the device. Maximum Ratings are stress ratings only. Functional operation above the Recommended Operating Conditions is not implied. Extended exposure to stresses above the Recommended Operating Conditions may affect device reliability.

*For additional information on our Pb-Free strategy and soldering details, please download the ON Semiconductor Soldering and Mounting Techniques Reference Manual, SOLDERRM/D.

ORDERING INFORMATION

| Device | Mark | Package | Shipping† |
|----------------|------|----------------------|------------------------|
| BC846BPDW1T1G | BB | SOT-363 (Pb-Free) | 3,000 / Tape & Reel |
| SBC846BPDW1T1G | BB | SOT-363 (Pb-Free) | 3,000 / Tape & Reel |
| SBC846BPDW1T2G | BB | SOT-363 (Pb-Free) | 3,000 / Tape & Reel |
| BC847BPDW1T1G | BF | SOT-363 (Pb-Free) | 3,000 / Tape & Reel |
| SBC847BPDW1T1G | BF | SOT-363 (Pb-Free) | 3,000 / Tape & Reel |
| BC847BPDW1T2G | BF | SOT-363 (Pb-Free) | 3,000 / Tape & Reel |
| BC848CPDW1T1G | BL | SOT-363 (Pb-Free) | 3,000 / Tape & Reel |

†For information on tape and reel specifications, including part orientation and tape sizes, please refer to our Tape and Reel Packaging Specification Brochure, BRD8011/D.

**BC846BPDW1T1G, SBC846BPDW1T1G, BC847BPDW1T1G,
SBC847BPDW1T1G Series, BC848CPDW1T1G**

THERMAL CHARACTERISTICS

| Characteristic | Symbol | Max | Unit |
|---|-----------------|-------------------|--|
| Total Device Dissipation Per Device FR-5 Board (Note 1) $T_A = 25^\circ\text{C}$ Derate above 25°C | P_D | 380 250 3.0 | mW mW/ $^\circ\text{C}$ mW/ $^\circ\text{C}$ |
| Thermal Resistance, Junction-to-Ambient | $R_{\theta JA}$ | 328 | $^\circ\text{C/W}$ |
| Junction and Storage Temperature | T_J, T_{stg} | -55 to +150 | $^\circ\text{C}$ |

1. FR-5 = 1.0 x 0.75 x 0.062 in.

ELECTRICAL CHARACTERISTICS (NPN) ($T_A = 25^\circ\text{C}$ unless otherwise noted)

| Characteristic | Symbol | Min | Typ | Max | Unit |
|----------------|--------|-----|-----|-----|------|
|----------------|--------|-----|-----|-----|------|

OFF CHARACTERISTICS

| | | | | | |
|--|---------------|-------------------|-------------|-------------|---------------------|
| Collector - Emitter Breakdown Voltage ($I_C = 10\text{ mA}$) BC846, SBC846 Series BC847, SBC847 Series BC848 Series | $V_{(BR)CEO}$ | 65 45 30 | - - - | - - - | V |
| Collector - Emitter Breakdown Voltage ($I_C = 10\ \mu\text{A}, V_{EB} = 0$) BC846, SBC846 Series BC847B, SBC847B Only BC848 Series | $V_{(BR)CES}$ | 80 50 30 | - - - | - - - | V |
| Collector - Base Breakdown Voltage ($I_C = 10\ \mu\text{A}$) BC846, SBC846 Series BC847, SBC847 Series BC848 Series | $V_{(BR)CBO}$ | 80 50 30 | - - - | - - - | V |
| Emitter - Base Breakdown Voltage ($I_E = 1.0\ \mu\text{A}$) BC846, SBC846 Series BC847, SBC847 Series BC848 Series | $V_{(BR)EBO}$ | 6.0 6.0 5.0 | - - - | - - - | V |
| Collector Cutoff Current ($V_{CB} = 30\text{ V}$) ($V_{CB} = 30\text{ V}, T_A = 150^\circ\text{C}$) | I_{CBO} | - - | - - | 15 5.0 | nA μA |

ON CHARACTERISTICS

| | | | | | |
|---|---------------|----------------------|--------------------------|----------------------|----|
| DC Current Gain ($I_C = 10\ \mu\text{A}, V_{CE} = 5.0\text{ V}$) BC846B, SBC846B, BC847B, SBC847B BC848C ($I_C = 2.0\text{ mA}, V_{CE} = 5.0\text{ V}$) BC846B, SBC846B, BC847B, SBC847B BC848C | h_{FE} | - - 200 420 | 150 270 290 520 | - - 475 800 | - |
| Collector - Emitter Saturation Voltage ($I_C = 10\text{ mA}, I_B = 0.5\text{ mA}$) ($I_C = 100\text{ mA}, I_B = 5.0\text{ mA}$) | $V_{CE(sat)}$ | - - | - - | 0.25 0.6 | V |
| Base - Emitter Saturation Voltage ($I_C = 10\text{ mA}, I_B = 0.5\text{ mA}$) ($I_C = 100\text{ mA}, I_B = 5.0\text{ mA}$) | $V_{BE(sat)}$ | - - | 0.7 0.9 | - - | V |
| Base - Emitter Voltage ($I_C = 2.0\text{ mA}, V_{CE} = 5.0\text{ V}$) ($I_C = 10\text{ mA}, V_{CE} = 5.0\text{ V}$) | $V_{BE(on)}$ | 580 - | 660 - | 700 770 | mV |

SMALL-SIGNAL CHARACTERISTICS

| | | | | | |
|--|-----------|-----|---|-----|-----|
| Current - Gain - Bandwidth Product ($I_C = 10\text{ mA}, V_{CE} = 5.0\text{ Vdc}, f = 100\text{ MHz}$) | f_T | 100 | - | - | MHz |
| Output Capacitance ($V_{CB} = 10\text{ V}, f = 1.0\text{ MHz}$) | C_{obo} | - | - | 4.5 | pF |
| Noise Figure ($I_C = 0.2\text{ mA}, V_{CE} = 5.0\text{ Vdc}, R_S = 2.0\text{ k}\Omega, f = 1.0\text{ kHz}, BW = 200\text{ Hz}$) | NF | - | - | 10 | dB |

**BC846BPDW1T1G, SBC846BPDW1T1G, BC847BPDW1T1G,
SBC847BPDW1T1G Series, BC848CPDW1T1G**

ELECTRICAL CHARACTERISTICS (PNP) ($T_A = 25^\circ\text{C}$ unless otherwise noted)

| Characteristic | Symbol | Min | Typ | Max | Unit |
|--|---------------|----------------------|-------------|-------------|---------------------|
| OFF CHARACTERISTICS | | | | | |
| Collector – Emitter Breakdown Voltage ($I_C = -10\text{ mA}$) BC846, SBC846 Series BC847, SBC847 Series BC848 Series | $V_{(BR)CEO}$ | -65 -45 -30 | - - - | - - - | V |
| Collector – Emitter Breakdown Voltage ($I_C = -10\text{ }\mu\text{A}$, $V_{EB} = 0$) BC846, SBC846 Series BC847, SBC847 Series BC848 Series | $V_{(BR)CES}$ | -80 -50 -30 | - - - | - - - | V |
| Collector – Base Breakdown Voltage ($I_C = -10\text{ }\mu\text{A}$) BC846, SBC846 Series BC847, SBC847 Series BC848 Series | $V_{(BR)CBO}$ | -80 -50 -30 | - - - | - - - | V |
| Emitter – Base Breakdown Voltage ($I_E = -1.0\text{ }\mu\text{A}$) BC846, SBC846 Series BC847, SBC847 Series BC848 Series | $V_{(BR)EBO}$ | -5.0 -5.0 -5.0 | - - - | - - - | V |
| Collector Cutoff Current ($V_{CB} = -30\text{ V}$) ($V_{CB} = -30\text{ V}$, $T_A = 150^\circ\text{C}$) | I_{CBO} | - - | - - | -15 -4.0 | nA μA |

ON CHARACTERISTICS

| | | | | | |
|---|---------------|----------------------|--------------------------|----------------------|---|
| DC Current Gain ($I_C = -10\text{ }\mu\text{A}$, $V_{CE} = -5.0\text{ V}$) BC846B, SBC846B, BC847B, SBC847B BC848C ($I_C = -2.0\text{ mA}$, $V_{CE} = -5.0\text{ V}$) BC846B, SBC846B, BC847B, SBC847B BC848C | h_{FE} | - - 200 420 | 150 270 290 520 | - - 475 800 | - |
| Collector – Emitter Saturation Voltage ($I_C = -10\text{ mA}$, $I_B = -0.5\text{ mA}$) ($I_C = -100\text{ mA}$, $I_B = -5.0\text{ mA}$) | $V_{CE(sat)}$ | - - | - - | -0.3 -0.65 | V |
| Base – Emitter Saturation Voltage ($I_C = -10\text{ mA}$, $I_B = -0.5\text{ mA}$) ($I_C = -100\text{ mA}$, $I_B = -5.0\text{ mA}$) | $V_{BE(sat)}$ | - - | -0.7 -0.9 | - - | V |
| Base – Emitter On Voltage ($I_C = -2.0\text{ mA}$, $V_{CE} = -5.0\text{ V}$) ($I_C = -10\text{ mA}$, $V_{CE} = -5.0\text{ V}$) | $V_{BE(on)}$ | -0.6 - | - - | -0.75 -0.82 | V |

SMALL-SIGNAL CHARACTERISTICS

| | | | | | |
|--|----------|-----|---|-----|-----|
| Current – Gain – Bandwidth Product ($I_C = -10\text{ mA}$, $V_{CE} = -5.0\text{ Vdc}$, $f = 100\text{ MHz}$) | f_T | 100 | - | - | MHz |
| Output Capacitance ($V_{CB} = -10\text{ V}$, $f = 1.0\text{ MHz}$) | C_{ob} | - | - | 4.5 | pF |
| Noise Figure ($I_C = -0.2\text{ mA}$, $V_{CE} = -5.0\text{ Vdc}$, $R_S = 2.0\text{ k}\Omega$, $f = 1.0\text{ kHz}$, $BW = 200\text{ Hz}$) | NF | - | - | 10 | dB |

**BC846BPDW1T1G, SBC846BPDW1T1G, BC847BPDW1T1G,
SBC847BPDW1T1G Series, BC848CPDW1T1G**

TYPICAL NPN CHARACTERISTICS – BC846/SBC846

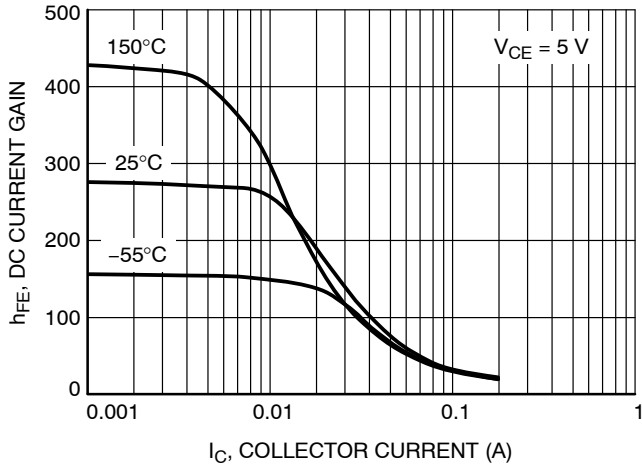

Figure 1. DC Current Gain vs. Collector Current

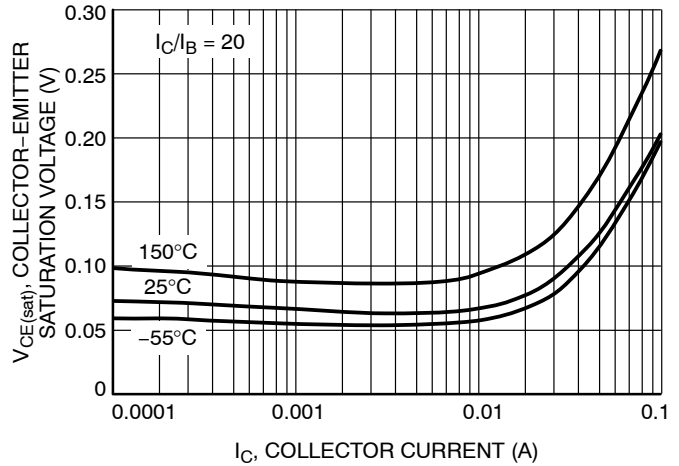

Figure 2. Collector Emitter Saturation Voltage vs. Collector Current

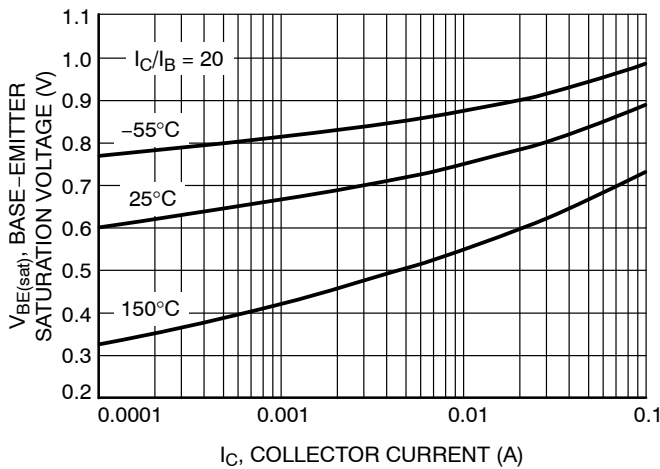

Figure 3. Base Emitter Saturation Voltage vs. Collector Current

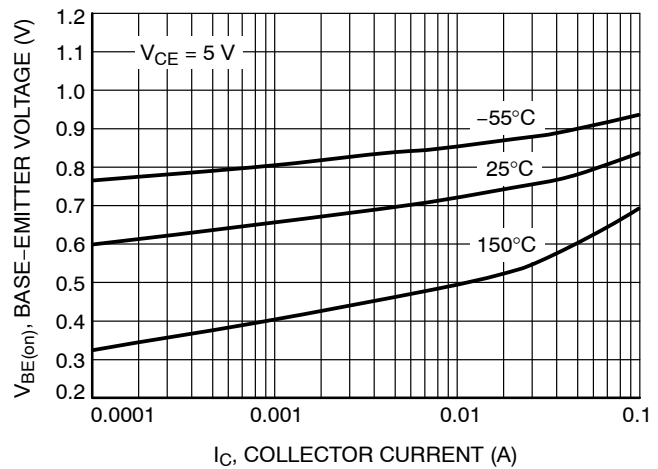

Figure 4. Base Emitter Voltage vs. Collector Current

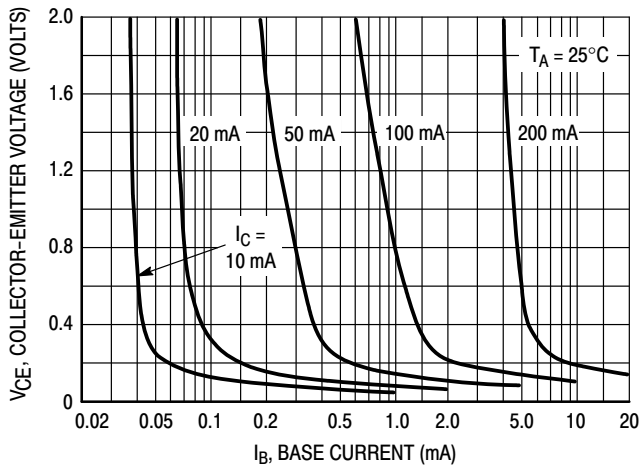

Figure 5. Collector Saturation Region

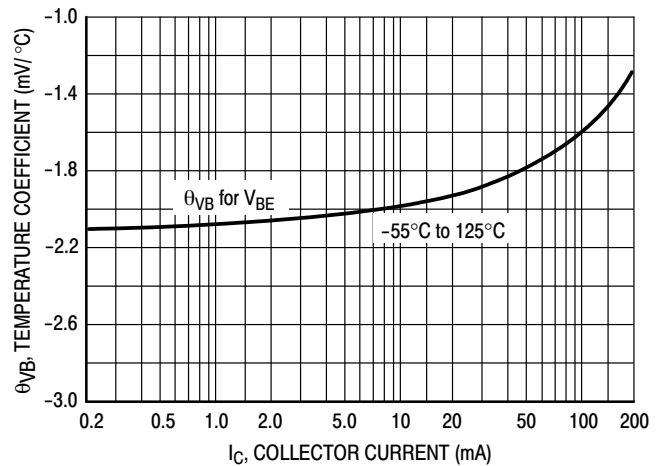

Figure 6. Base-Emitter Temperature Coefficient

**BC846BPDW1T1G, SBC846BPDW1T1G, BC847BPDW1T1G,
SBC847BPDW1T1G Series, BC848CPDW1T1G**

TYPICAL NPN CHARACTERISTICS – BC846/SBC846

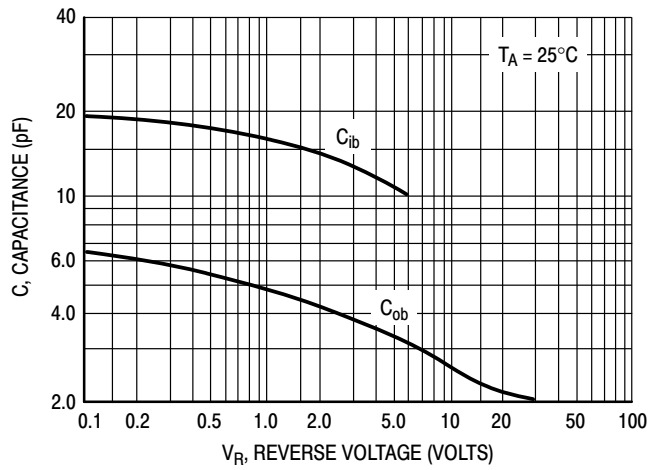

Figure 7. Capacitance

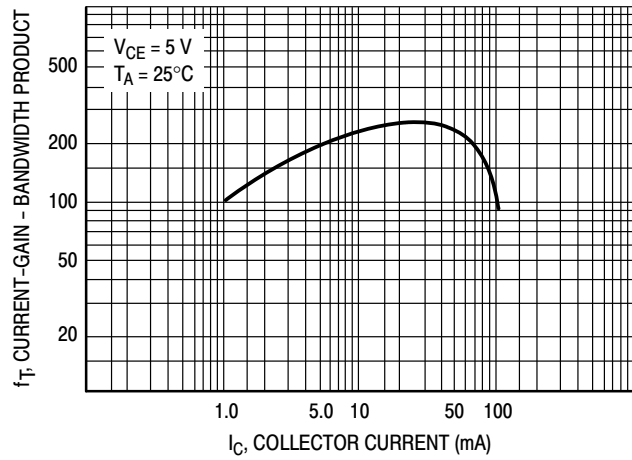

Figure 8. Current-Gain - Bandwidth Product

**BC846BPDW1T1G, SBC846BPDW1T1G, BC847BPDW1T1G,
SBC847BPDW1T1G Series, BC848CPDW1T1G**

TYPICAL PNP CHARACTERISTICS — BC846/SBC846

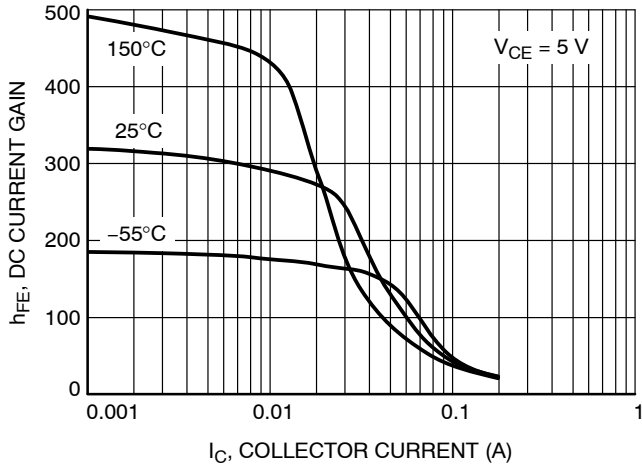

Figure 9. DC Current Gain vs. Collector Current

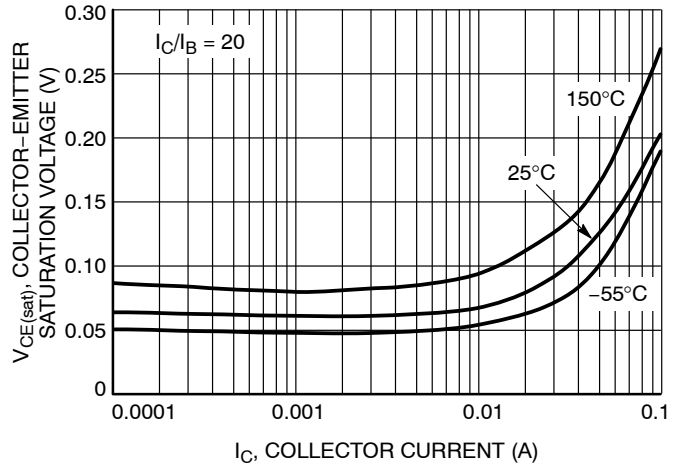

Figure 10. Collector Emitter Saturation Voltage vs. Collector Current

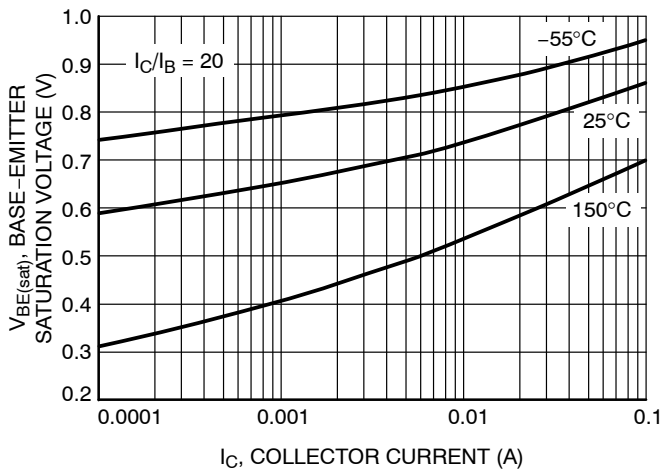

Figure 11. Base Emitter Saturation Voltage vs. Collector Current

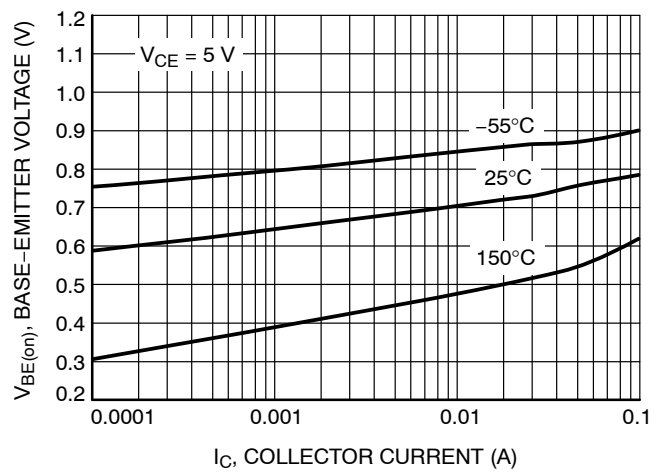

Figure 12. Base Emitter Voltage vs. Collector Current

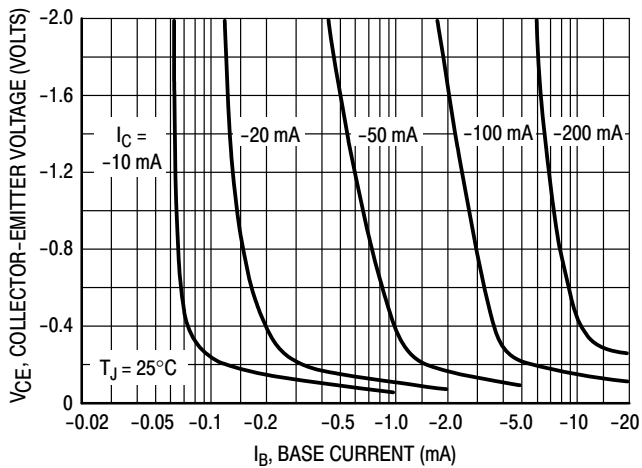

Figure 13. Collector Saturation Region

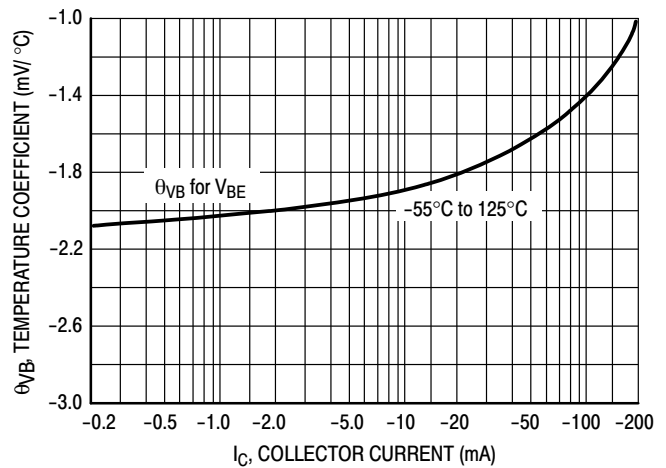

Figure 14. Base-Emitter Temperature Coefficient

**BC846BPDW1T1G, SBC846BPDW1T1G, BC847BPDW1T1G,
SBC847BPDW1T1G Series, BC848CPDW1T1G**

TYPICAL PNP CHARACTERISTICS — BC846/SBC846

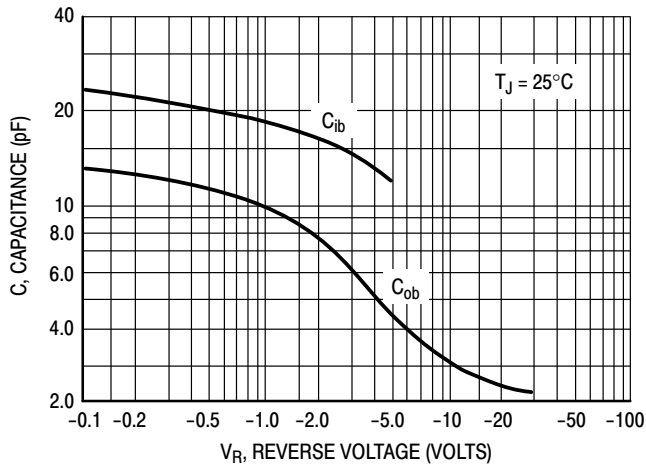

Figure 15. Capacitance

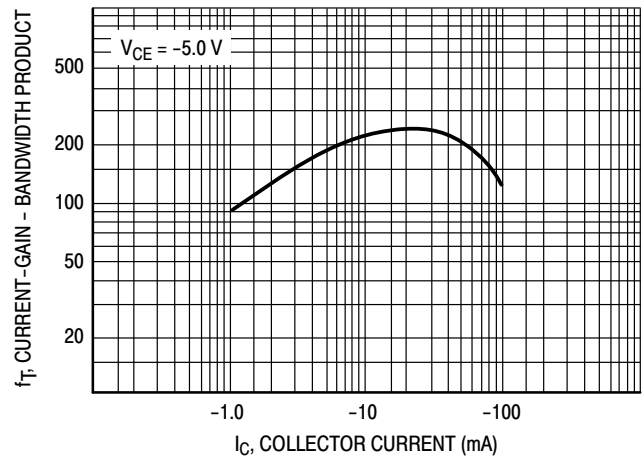

Figure 16. Current-Gain - Bandwidth Product

**BC846BPDW1T1G, SBC846BPDW1T1G, BC847BPDW1T1G,
SBC847BPDW1T1G Series, BC848CPDW1T1G**

TYPICAL NPN CHARACTERISTICS – BC847/SBC847 SERIES

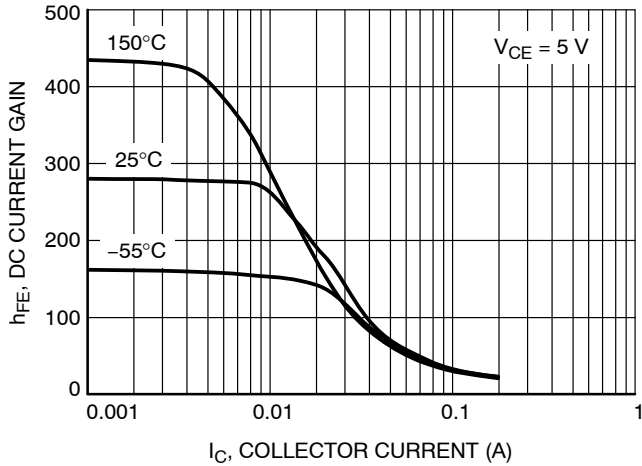

Figure 17. DC Current Gain vs. Collector Current

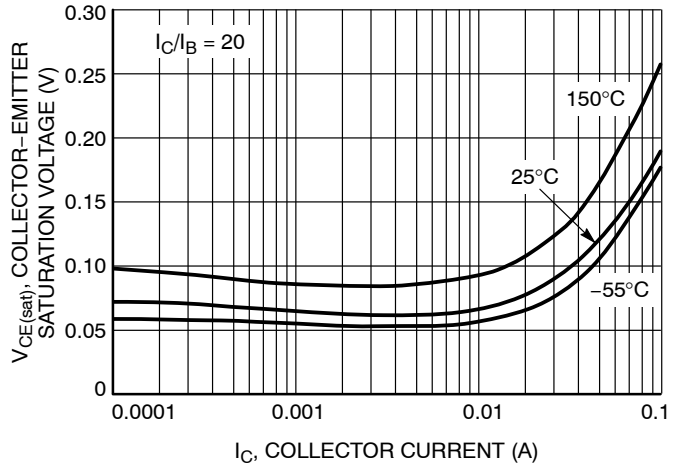

Figure 18. Collector Emitter Saturation Voltage vs. Collector Current

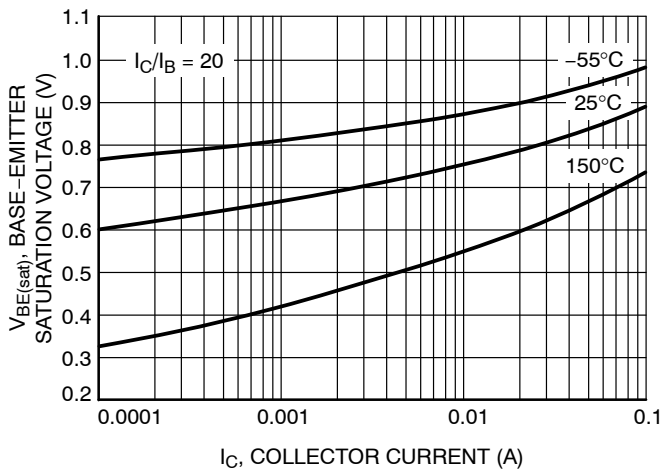

Figure 19. Base Emitter Saturation Voltage vs. Collector Current

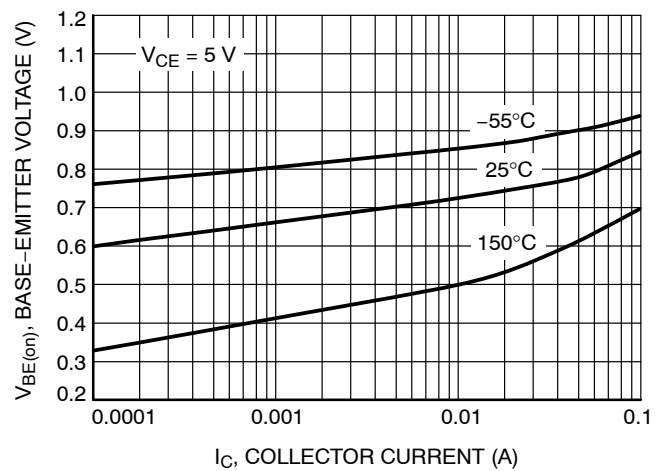

Figure 20. Base Emitter Voltage vs. Collector Current

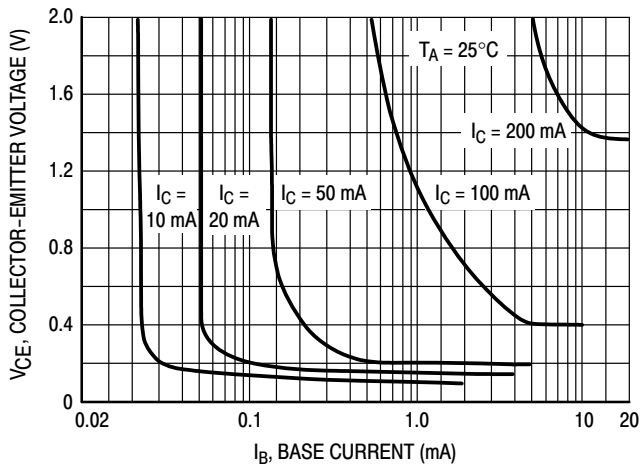

Figure 21. Collector Saturation Region

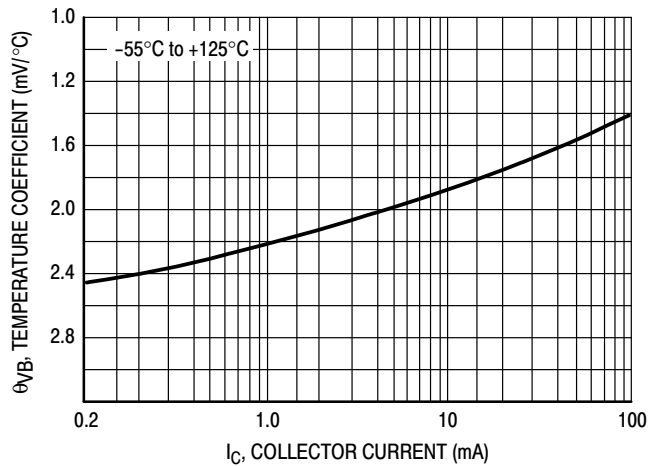

Figure 22. Base-Emitter Temperature Coefficient

**BC846BPDW1T1G, SBC846BPDW1T1G, BC847BPDW1T1G,
SBC847BPDW1T1G Series, BC848CPDW1T1G**

TYPICAL NPN CHARACTERISTICS – BC847/SBC847 SERIES

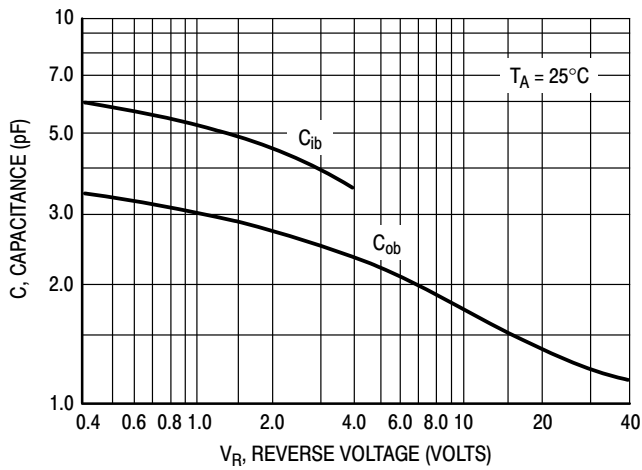

Figure 23. Capacitances

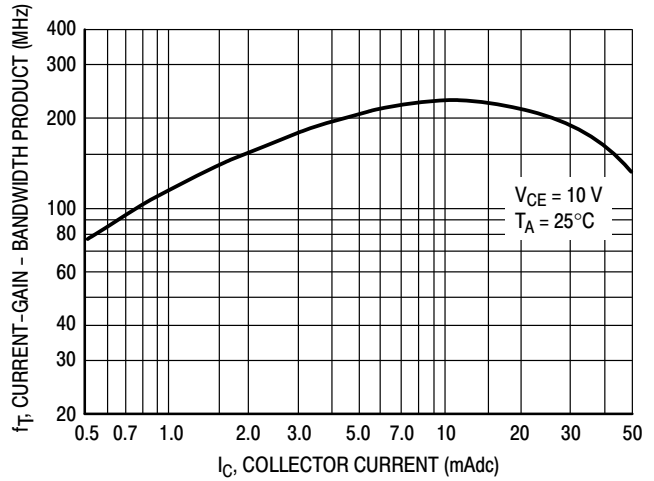

Figure 24. Current-Gain - Bandwidth Product

**BC846BPDW1T1G, SBC846BPDW1T1G, BC847BPDW1T1G,
SBC847BPDW1T1G Series, BC848CPDW1T1G**

TYPICAL PNP CHARACTERISTICS – BC847/SBC847 SERIES

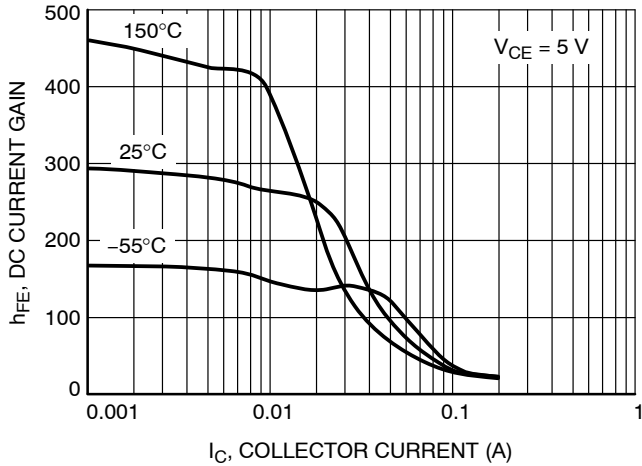

Figure 25. DC Current Gain vs. Collector Current

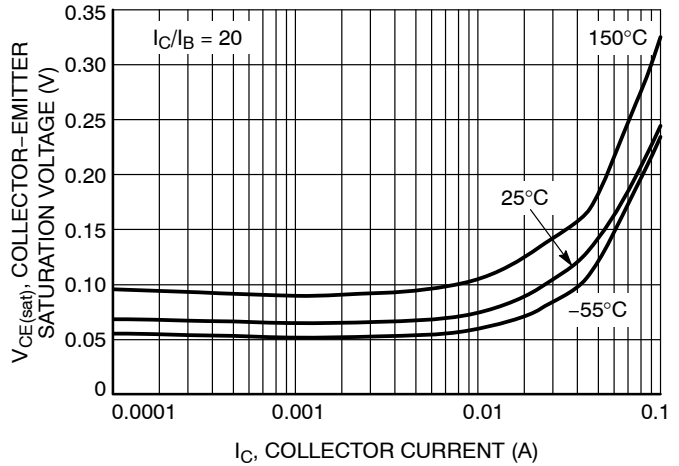

Figure 26. Collector Emitter Saturation Voltage vs. Collector Current

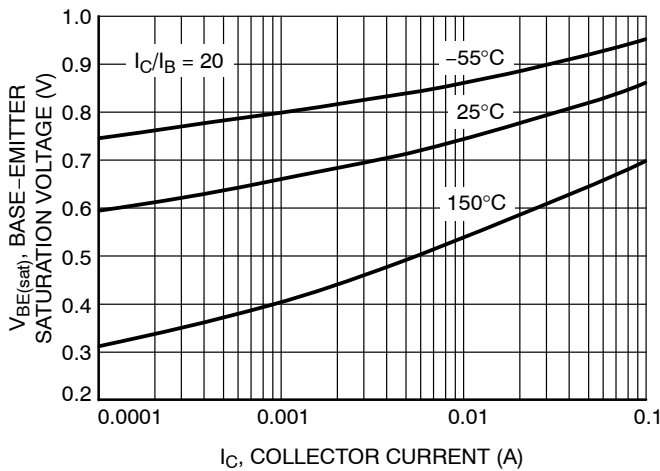

Figure 27. Base Emitter Saturation Voltage vs. Collector Current

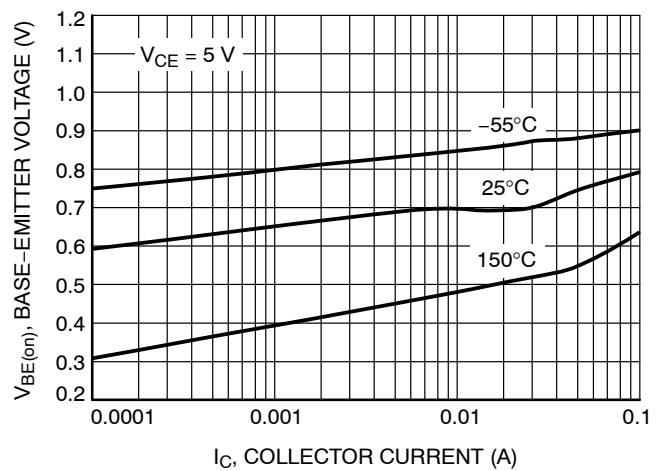

Figure 28. Base Emitter Voltage vs. Collector Current

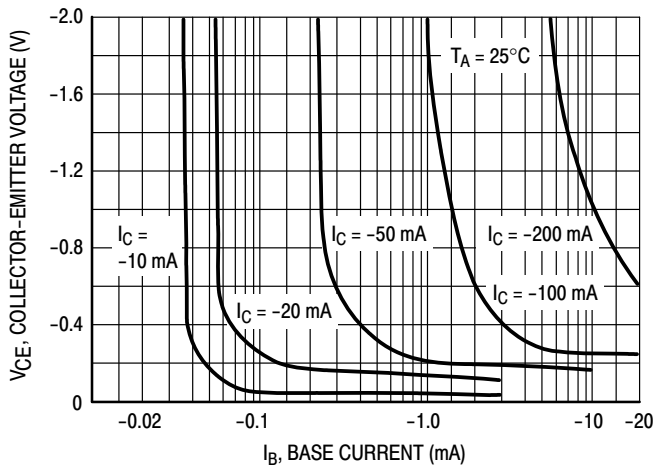

Figure 29. Collector Saturation Region

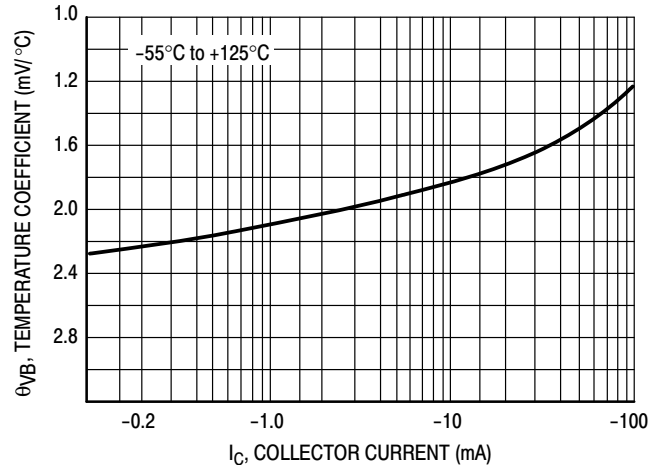

Figure 30. Base-Emitter Temperature Coefficient

**BC846BPDW1T1G, SBC846BPDW1T1G, BC847BPDW1T1G,
SBC847BPDW1T1G Series, BC848CPDW1T1G**

TYPICAL PNP CHARACTERISTICS – BC847/SBC847 SERIES

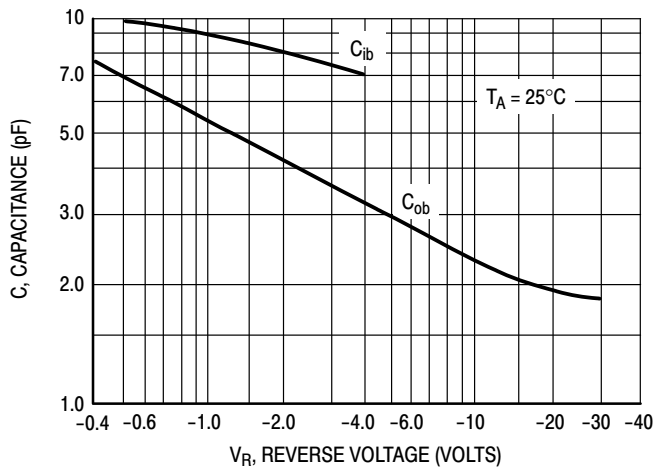

Figure 31. Capacitances

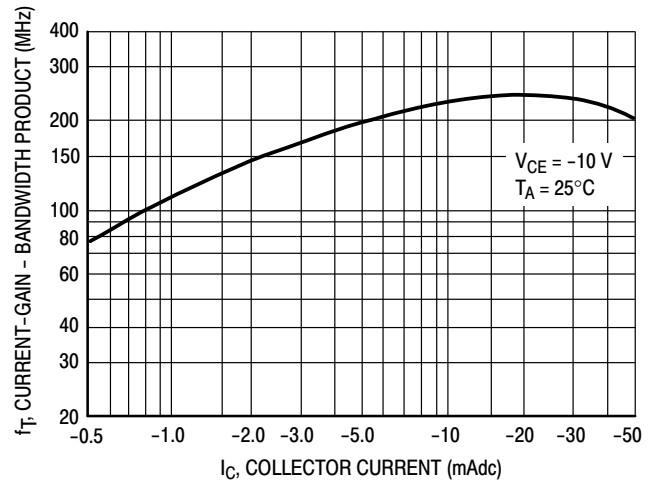

Figure 32. Current-Gain - Bandwidth Product

**BC846BPDW1T1G, SBC846BPDW1T1G, BC847BPDW1T1G,
SBC847BPDW1T1G Series, BC848CPDW1T1G**

TYPICAL NPN CHARACTERISTICS - BC848 SERIES

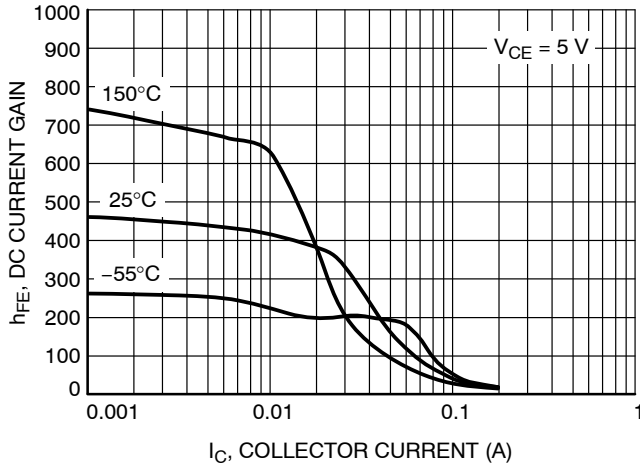

Figure 33. DC Current Gain vs. Collector Current

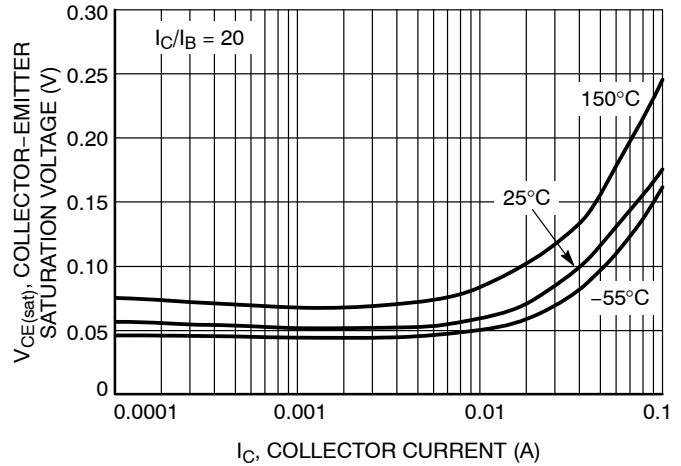

Figure 34. Collector Emitter Saturation Voltage vs. Collector Current

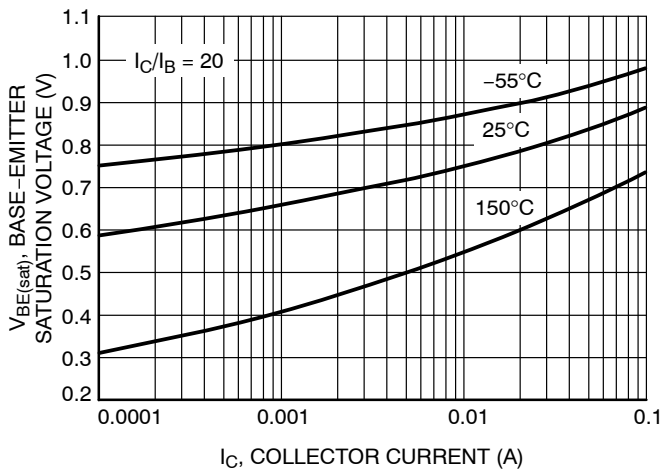

Figure 35. Base Emitter Saturation Voltage vs. Collector Current

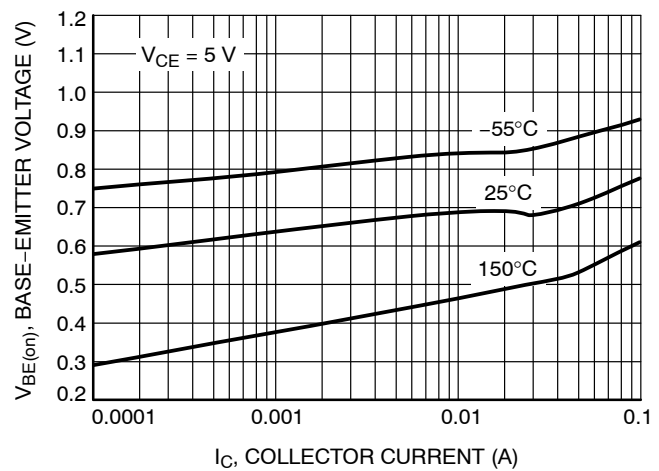

Figure 36. Base Emitter Voltage vs. Collector Current

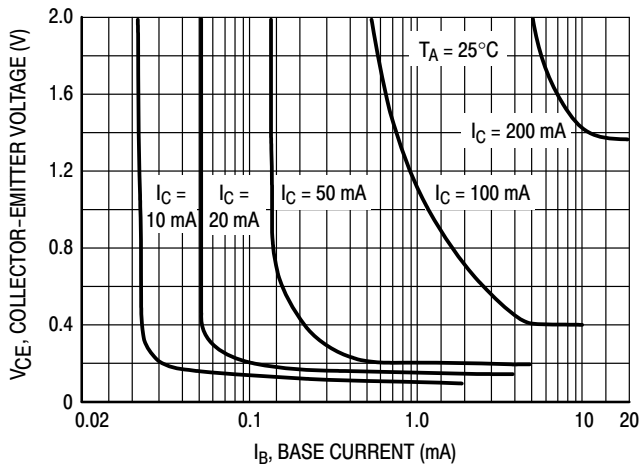

Figure 37. Collector Saturation Region

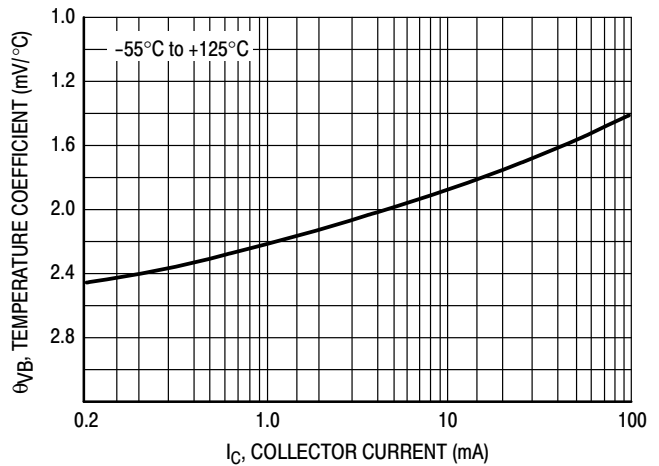

Figure 38. Base-Emitter Temperature Coefficient

**BC846BPDW1T1G, SBC846BPDW1T1G, BC847BPDW1T1G,
SBC847BPDW1T1G Series, BC848CPDW1T1G**

TYPICAL NPN CHARACTERISTICS – BC848 SERIES

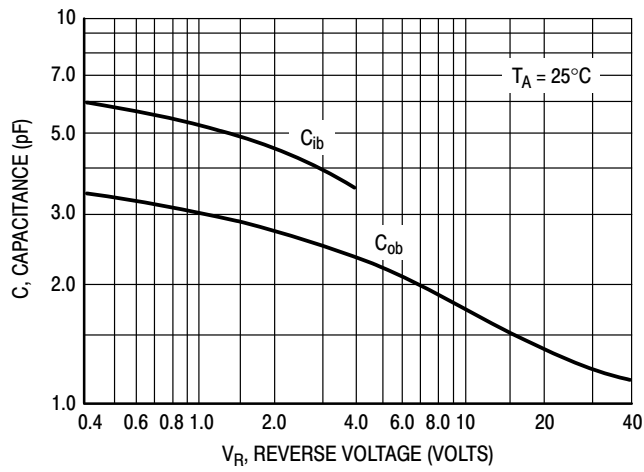

Figure 39. Capacitances

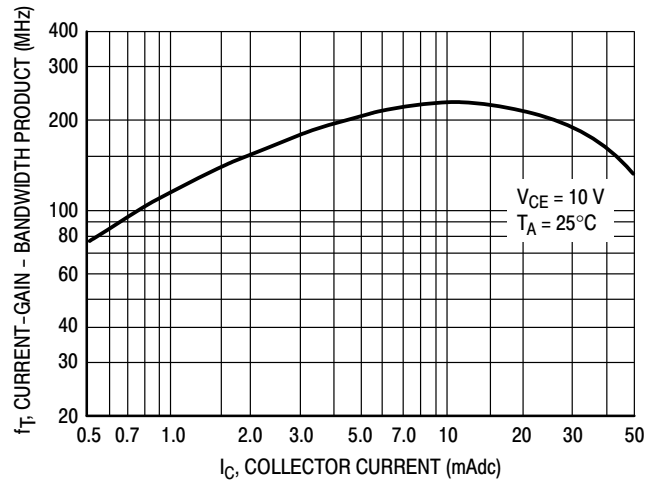

Figure 40. Current-Gain - Bandwidth Product

**BC846BPDW1T1G, SBC846BPDW1T1G, BC847BPDW1T1G,
SBC847BPDW1T1G Series, BC848CPDW1T1G**

TYPICAL PNP CHARACTERISTICS - BC848 SERIES

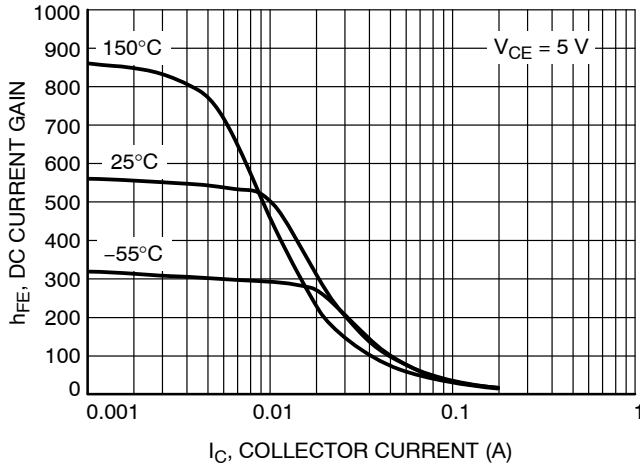

Figure 41. DC Current Gain vs. Collector Current

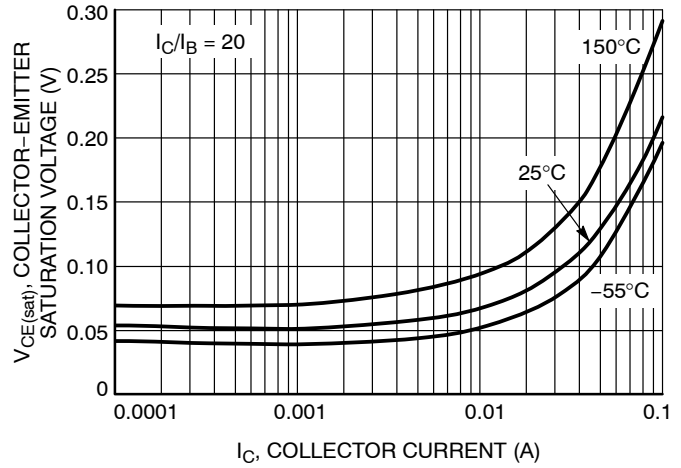

Figure 42. Collector Emitter Saturation Voltage vs. Collector Current

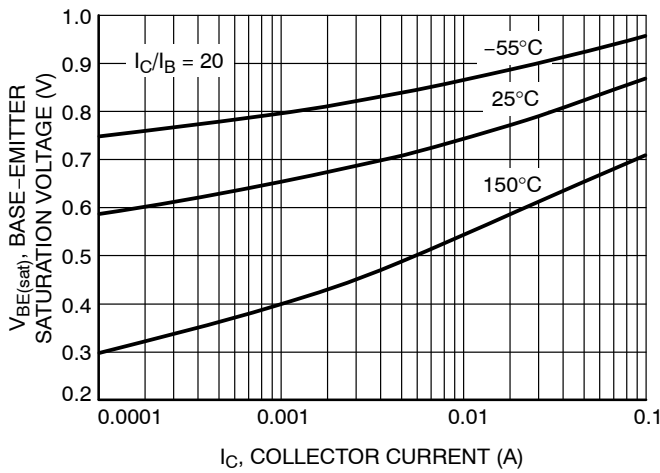

Figure 43. Base Emitter Saturation Voltage vs. Collector Current

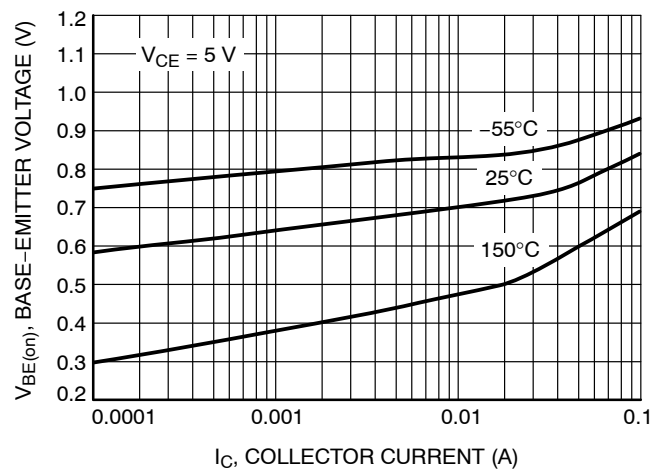

Figure 44. Base Emitter Voltage vs. Collector Current

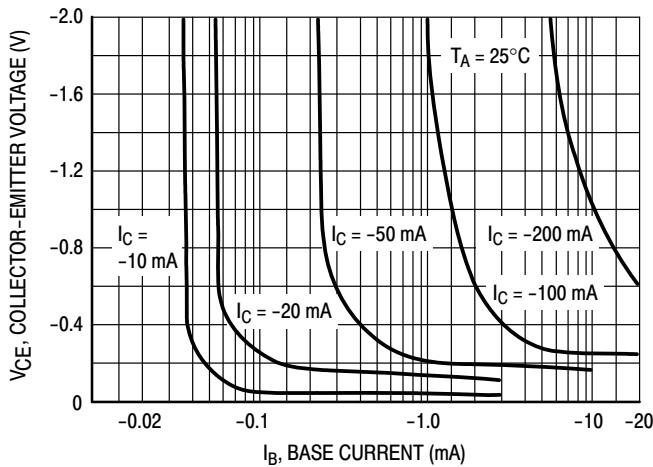

Figure 45. Collector Saturation Region

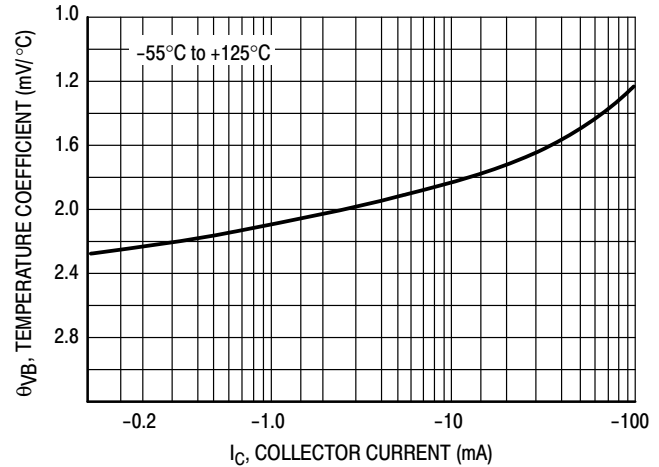

Figure 46. Base-Emitter Temperature Coefficient

**BC846BPDW1T1G, SBC846BPDW1T1G, BC847BPDW1T1G,
SBC847BPDW1T1G Series, BC848CPDW1T1G**

TYPICAL PNP CHARACTERISTICS – BC848 SERIES

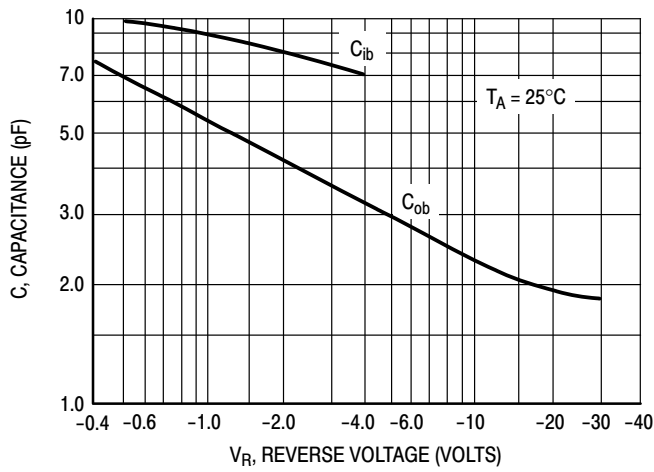

Figure 47. Capacitances

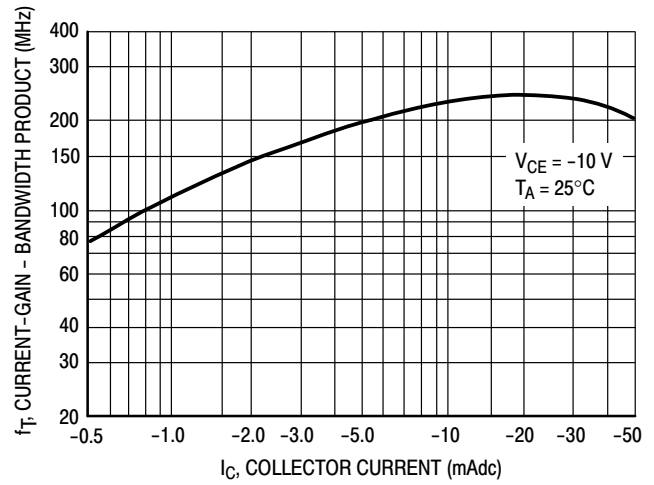

Figure 48. Current-Gain - Bandwidth Product

**BC846BPDW1T1G, SBC846BPDW1T1G, BC847BPDW1T1G,
SBC847BPDW1T1G Series, BC848CPDW1T1G**

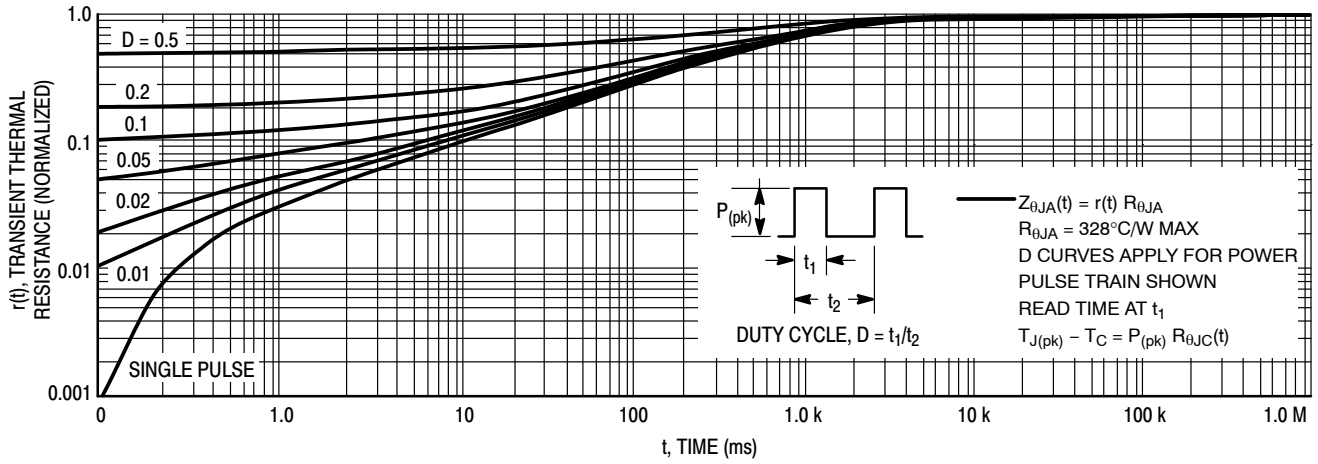

Figure 49. Thermal Response

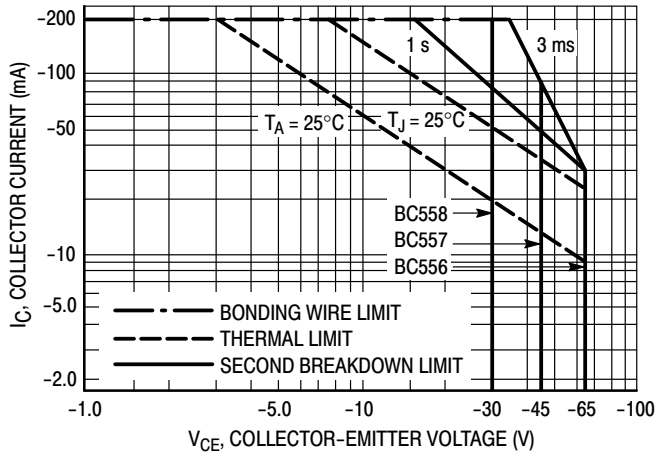

Figure 50. Active Region Safe Operating Area

The safe operating area curves indicate I_C - V_{CE} limits of the transistor that must be observed for reliable operation. Collector load lines for specific circuits must fall below the limits indicated by the applicable curve.

The data of Figure 50 is based upon $T_{J(pk)} = 150^\circ\text{C}$; T_C or T_A is variable depending upon conditions. Pulse curves are valid for duty cycles to 10% provided $T_{J(pk)} \leq 150^\circ\text{C}$. $T_{J(pk)}$ may be calculated from the data in Figure 49. At high case or ambient temperatures, thermal limitations will reduce the power that can be handled to values less than the limitations imposed by the secondary breakdown.

BC846BPDW1T1G, SBC846BPDW1T1G, BC847BPDW1T1G, SBC847BPDW1T1G Series, BC848CPDW1T1G

PACKAGE DIMENSIONS

SC-88/SOT-363/SC70-6

CASE 419B-02

ISSUE W

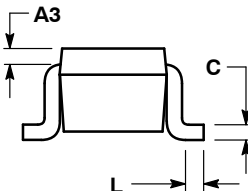
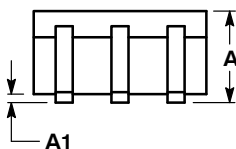
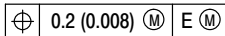
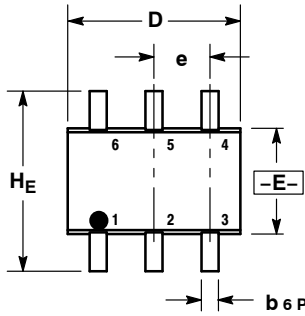

NOTES:

1. DIMENSIONING AND TOLERANCING PER ANSI Y14.5M, 1982.
2. CONTROLLING DIMENSION: INCH.
3. 419B-01 OBSOLETE, NEW STANDARD 419B-02.

| DIM | MILLIMETERS | | | INCHES | | |
|-----|-------------|------|------|-----------|-------|-------|
| | MIN | NOM | MAX | MIN | NOM | MAX |
| A | 0.80 | 0.95 | 1.10 | 0.031 | 0.037 | 0.043 |
| A1 | 0.00 | 0.05 | 0.10 | 0.000 | 0.002 | 0.004 |
| A3 | 0.20 REF | | | 0.008 REF | | |
| b | 0.10 | 0.21 | 0.30 | 0.004 | 0.008 | 0.012 |
| C | 0.10 | 0.14 | 0.25 | 0.004 | 0.005 | 0.010 |
| D | 1.80 | 2.00 | 2.20 | 0.070 | 0.078 | 0.086 |
| E | 1.15 | 1.25 | 1.35 | 0.045 | 0.049 | 0.053 |
| e | 0.65 BSC | | | 0.026 BSC | | |
| L | 0.10 | 0.20 | 0.30 | 0.004 | 0.008 | 0.012 |
| HE | 2.00 | 2.10 | 2.20 | 0.078 | 0.082 | 0.086 |

STYLE 1:

- PIN 1. EMITTER 2
- BASE 2
- COLLECTOR 1
- EMITTER 1
- BASE 1
- COLLECTOR 2

SOLDERING FOOTPRINT*

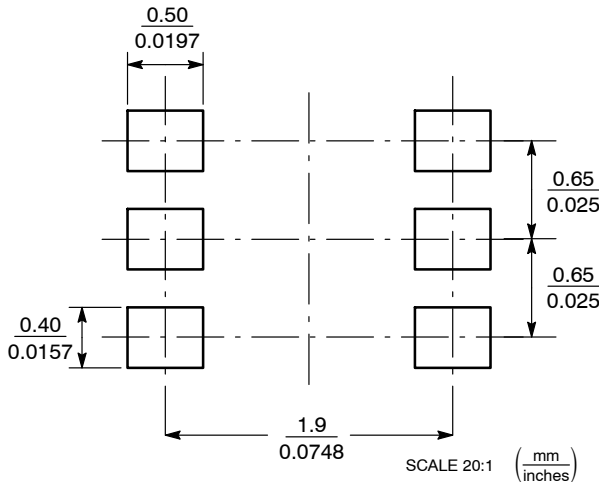

SC-88/SC70-6/SOT-363

*For additional information on our Pb-Free strategy and soldering details, please download the ON Semiconductor Soldering and Mounting Techniques Reference Manual, SOLDERRM/D.

ON Semiconductor and are registered trademarks of Semiconductor Components Industries, LLC (SCILLC). SCILLC owns the rights to a number of patents, trademarks, copyrights, trade secrets, and other intellectual property. A listing of SCILLC's product/patent coverage may be accessed at www.onsemi.com/site/pdf/Patent-Marking.pdf. SCILLC reserves the right to make changes without further notice to any products herein. SCILLC makes no warranty, representation or guarantee regarding the suitability of its products for any particular purpose, nor does SCILLC assume any liability arising out of the application or use of any product or circuit, and specifically disclaims any and all liability, including without limitation special, consequential or incidental damages. "Typical" parameters which may be provided in SCILLC data sheets and/or specifications can and do vary in different applications and actual performance may vary over time. All operating parameters, including "Typicals" must be validated for each customer application by customer's technical experts. SCILLC does not convey any license under its patent rights nor the rights of others. SCILLC products are not designed, intended, or authorized for use as components in systems intended for surgical implant into the body, or other applications intended to support or sustain life, or for any other application in which the failure of the SCILLC product could create a situation where personal injury or death may occur. Should Buyer purchase or use SCILLC products for any such unintended or unauthorized application, Buyer shall indemnify and hold SCILLC and its officers, employees, subsidiaries, affiliates, and distributors harmless against all claims, costs, damages, and expenses, and reasonable attorney fees arising out of, directly or indirectly, any claim of personal injury or death associated with such unintended or unauthorized use, even if such claim alleges that SCILLC was negligent regarding the design or manufacture of the part. SCILLC is an Equal Opportunity/Affirmative Action Employer. This literature is subject to all applicable copyright laws and is not for resale in any manner.

PUBLICATION ORDERING INFORMATION

LITERATURE FULFILLMENT:
Literature Distribution Center for ON Semiconductor
P.O. Box 5163, Denver, Colorado 80217 USA
Phone: 303-675-2175 or 800-344-3860 Toll Free USA/Canada
Fax: 303-675-2176 or 800-344-3867 Toll Free USA/Canada
Email: orderlit@onsemi.com

N. American Technical Support: 800-282-9855 Toll Free
USA/Canada
Europe, Middle East and Africa Technical Support:
Phone: 421 33 790 2910
Japan Customer Focus Center
Phone: 81-3-5817-1050

ON Semiconductor Website: www.onsemi.com
Order Literature: <http://www.onsemi.com/orderlit>

For additional information, please contact your local Sales Representative

BC846BPDW1T1/D

Компания «Life Electronics» занимается поставками электронных компонентов импортного и отечественного производства от производителей и со складов крупных дистрибьюторов Европы, Америки и Азии.

С конца 2013 года компания активно расширяет линейку поставок компонентов по направлению коаксиальный кабель, кварцевые генераторы и конденсаторы (керамические, пленочные, электролитические), за счёт заключения дистрибьюторских договоров

Мы предлагаем:

- Конкурентоспособные цены и скидки постоянным клиентам.
- Специальные условия для постоянных клиентов.
- Подбор аналогов.
- Поставку компонентов в любых объемах, удовлетворяющих вашим потребностям.
- Приемлемые сроки поставки, возможна ускоренная поставка.
- Доставку товара в любую точку России и стран СНГ.
- Комплексную поставку.
- Работу по проектам и поставку образцов.
- Формирование склада под заказчика.
- Сертификаты соответствия на поставляемую продукцию (по желанию клиента).
- Тестирование поставляемой продукции.
- Поставку компонентов, требующих военную и космическую приемку.
- Входной контроль качества.
- Наличие сертификата ISO.

В составе нашей компании организован Конструкторский отдел, призванный помогать разработчикам, и инженерам.

Конструкторский отдел помогает осуществить:

- Регистрацию проекта у производителя компонентов.
- Техническую поддержку проекта.
- Защиту от снятия компонента с производства.
- Оценку стоимости проекта по компонентам.
- Изготовление тестовой платы монтаж и пусконаладочные работы.



Тел: +7 (812) 336 43 04 (многоканальный)

Email: org@lifeelectronics.ru