

## Infrared Emitting Diode, 875 nm, GaAlAs

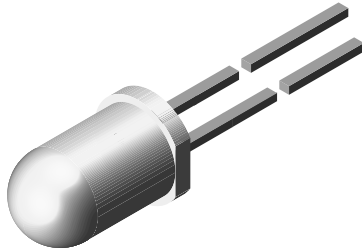

94 8389

### FEATURES

- Package type: leaded
- Package form: T-1 $\frac{3}{4}$
- Dimensions (in mm):  $\varnothing$  5
- Peak wavelength:  $\lambda_p = 875$  nm
- High reliability
- Angle of half intensity:  $\varphi = \pm 12^\circ$
- Low forward voltage
- Suitable for high pulse current operation
- Good spectral matching with Si photodetectors
- Compliant to RoHS directive 2002/95/EC and in accordance to WEEE 2002/96/EC
- Halogen-free according to IEC 61249-2-21 definition



**RoHS**  
COMPLIANT  
HALOGEN  
**FREE**

### DESCRIPTION

The TSHA620. series are infrared, 875 nm emitting diodes in GaAlAs technology, molded in a clear, untinted plastic package.

### APPLICATIONS

- Infrared remote control and free air data transmission systems
- This emitter series is dedicated to systems with panes in transmission space between emitter and detector, because of the low absorption of 875 nm radiation in glass

PRODUCT SUMMARY				
COMPONENT	$I_e$ (mW/sr)	$\varphi$ (deg)	$\lambda_p$ (nm)	$t_r$ (ns)
TSHA6200	40	$\pm 12$	875	600
TSHA6201	50	$\pm 12$	875	600
TSHA6202	60	$\pm 12$	875	600
TSHA6203	65	$\pm 12$	875	600

#### Note

Test conditions see table "Basic Characteristics"

ORDERING INFORMATION			
ORDERING CODE	PACKAGING	REMARKS	PACKAGE FORM
TSHA6200	Bulk	MOQ: 4000 pcs, 4000 pcs/bulk	T-1 $\frac{3}{4}$
TSHA6201	Bulk	MOQ: 4000 pcs, 4000 pcs/bulk	T-1 $\frac{3}{4}$
TSHA6202	Bulk	MOQ: 4000 pcs, 4000 pcs/bulk	T-1 $\frac{3}{4}$
TSHA6203	Bulk	MOQ: 4000 pcs, 4000 pcs/bulk	T-1 $\frac{3}{4}$

#### Note

MOQ: minimum order quantity

ABSOLUTE MAXIMUM RATINGS				
PARAMETER	TEST CONDITION	SYMBOL	VALUE	UNIT
Reverse voltage		$V_R$	5	V
Forward current		$I_F$	100	mA
Peak forward current	$t_p/T = 0.5, t_p = 100 \mu s$	$I_{FM}$	200	mA
Surge forward current	$t_p = 100 \mu s$	$I_{FSM}$	2.5	A
Power dissipation		$P_V$	180	mW
Junction temperature		$T_j$	100	$^\circ C$
Operating temperature range		$T_{amb}$	- 40 to + 85	$^\circ C$
Storage temperature range		$T_{stg}$	- 40 to + 100	$^\circ C$
Soldering temperature	$t \leq 5$ s, 2 mm from case	$T_{sd}$	260	$^\circ C$
Thermal resistance junction/ambient	J-STD-051, leads 7 mm, soldered on PCB	$R_{thJA}$	230	K/W

#### Note

$T_{amb} = 25 \text{ }^\circ C$ , unless otherwise specified

# TSHA6200, TSHA6201, TSHA6202, TSHA6203

Vishay Semiconductors Infrared Emitting Diode, 875 nm, GaAlAs

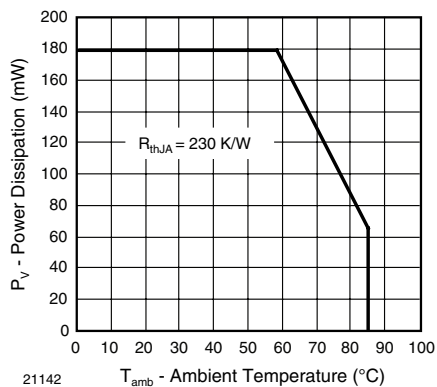

Fig. 1 - Power Dissipation Limit vs. Ambient Temperature

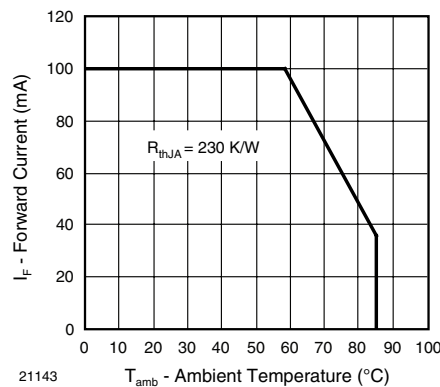

Fig. 2 - Forward Current Limit vs. Ambient Temperature

BASIC CHARACTERISTICS						
PARAMETER	TEST CONDITION	SYMBOL	MIN.	TYP.	MAX.	UNIT
Forward voltage	I <sub>F</sub> = 100 mA, t <sub>p</sub> = 20 ms	V <sub>F</sub>		1.5	1.8	V
Temperature coefficient of V <sub>F</sub>	I <sub>F</sub> = 100 mA	TK <sub>V<sub>F</sub></sub>		- 1.6		mV/K
Reverse current	V <sub>R</sub> = 5 V	I <sub>R</sub>			100	μA
Junction capacitance	V <sub>R</sub> = 0 V, f = 1 MHz, E = 0	C <sub>j</sub>		20		pF
Temperature coefficient of φ <sub>e</sub>	I <sub>F</sub> = 20 mA	TKφ <sub>e</sub>		- 0.7		%/K
Angle of half intensity		φ		± 12		deg
Peak wavelength	I <sub>F</sub> = 100 mA	λ <sub>p</sub>		875		nm
Spectral bandwidth	I <sub>F</sub> = 100 mA	Δλ		80		nm
Temperature coefficient of λ <sub>p</sub>	I <sub>F</sub> = 100 mA	TKλ <sub>p</sub>		0.2		nm/K
Rise time	I <sub>F</sub> = 100 mA	t <sub>r</sub>		600		ns
	I <sub>F</sub> = 1 A	t <sub>r</sub>		300		ns
Fall time	I <sub>F</sub> = 100 mA	t <sub>f</sub>		600		ns
	I <sub>F</sub> = 1 A	t <sub>f</sub>		300		ns
Virtual source diameter		d		3.7		mm

**Note**

T<sub>amb</sub> = 25 °C, unless otherwise specified



# TSHA6200, TSHA6201, TSHA6202, TSHA6203

Infrared Emitting Diode, 875 nm, GaAlAs Vishay Semiconductors

TYPE DEDICATED CHARACTERISTICS							
PARAMETER	TEST CONDITION	PART	SYMBOL	MIN.	TYP.	MAX.	UNIT
Forward voltage	$I_F = 1 \text{ A}$ , $t_p = 100 \mu\text{s}$	TSHA6200	$V_F$		2.8	3.5	V
		TSHA6201	$V_F$		2.8	3.5	V
		TSHA6202	$V_F$		2.8	3.5	V
		TSHA6203	$V_F$		2.8	3.5	V
Radiant intensity	$I_F = 100 \text{ mA}$ , $t_p = 20 \text{ ms}$	TSHA6200	$I_e$	25	40	125	mW/sr
		TSHA6201	$I_e$	30	50	125	mW/sr
		TSHA6202	$I_e$	36	60	125	mW/sr
		TSHA6203	$I_e$	50	65	125	mW/sr
	$I_F = 1 \text{ A}$ , $t_p = 100 \mu\text{s}$	TSHA6200	$I_e$	200	330		mW/sr
		TSHA6201	$I_e$	260	400		mW/sr
		TSHA6202	$I_e$	330	460		mW/sr
		TSHA6203	$I_e$	400	530		mW/sr
Radiant power	$I_F = 100 \text{ mA}$ , $t_p = 20 \text{ ms}$	TSHA6200	$\phi_e$		22		mW
		TSHA6201	$\phi_e$		23		mW
		TSHA6202	$\phi_e$		24		mW
		TSHA6203	$\phi_e$		25		mW

**Note**

$T_{amb} = 25 \text{ }^\circ\text{C}$ , unless otherwise specified

**BASIC CHARACTERISTICS**

$T_{amb} = 25 \text{ }^\circ\text{C}$ , unless otherwise specified

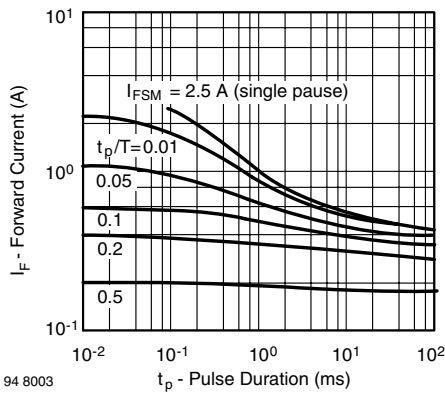

Fig. 3 - Pulse Forward Current vs. Pulse Duration

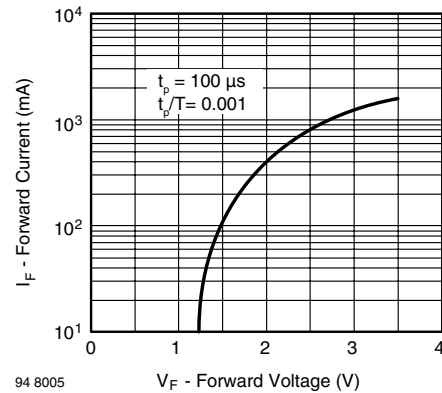

Fig. 4 - Forward Current vs. Forward Voltage

# TSHA6200, TSHA6201, TSHA6202, TSHA6203



Vishay Semiconductors Infrared Emitting Diode, 875 nm, GaAlAs

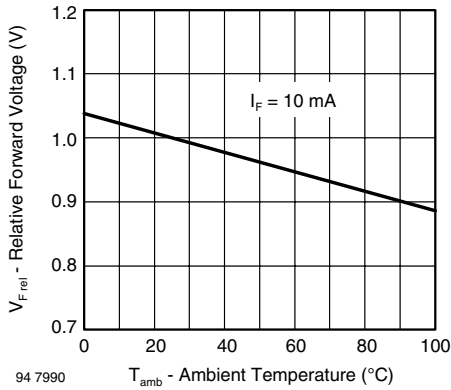

Fig. 5 - Relative Forward Voltage vs. Ambient Temperature

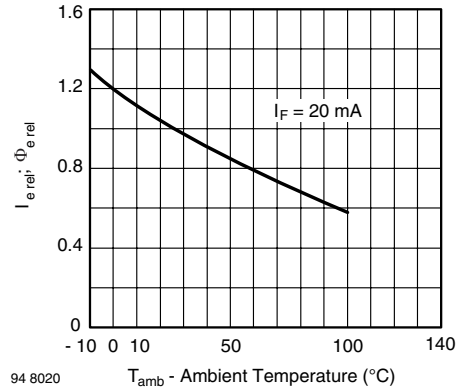

Fig. 8 - Relative Radiant Intensity/Power vs. Ambient Temperature

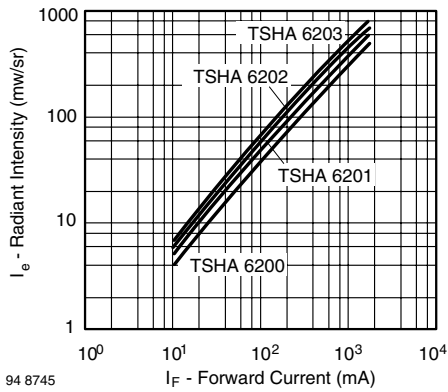

Fig. 6 - Radiant Intensity vs. Forward Current

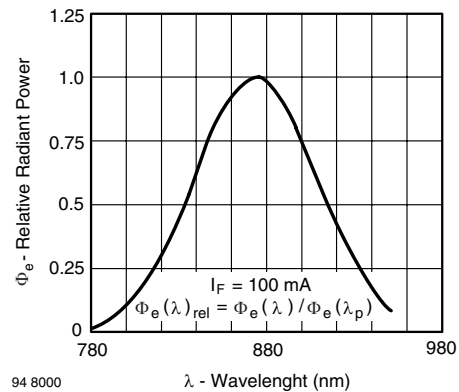

Fig. 9 - Relative Radiant Power vs. Wavelength

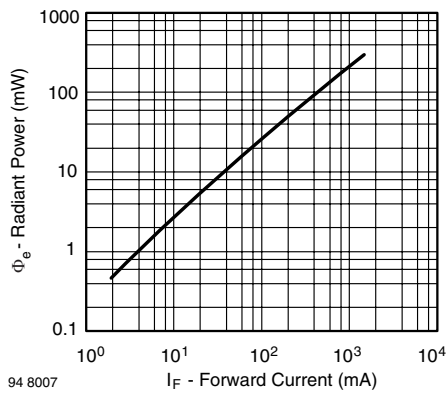

Fig. 7 - Radiant Power vs. Forward Current

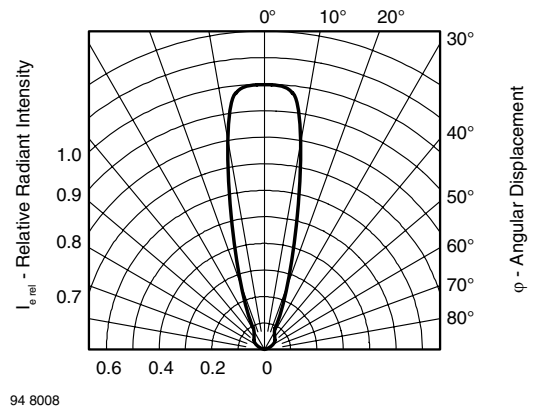

Fig. 10 - Relative Radiant Intensity vs. Angular Displacement



# TSHA6200, TSHA6201, TSHA6202, TSHA6203

Infrared Emitting Diode, 875 nm, GaAlAs Vishay Semiconductors

## PACKAGE DIMENSIONS in millimeters

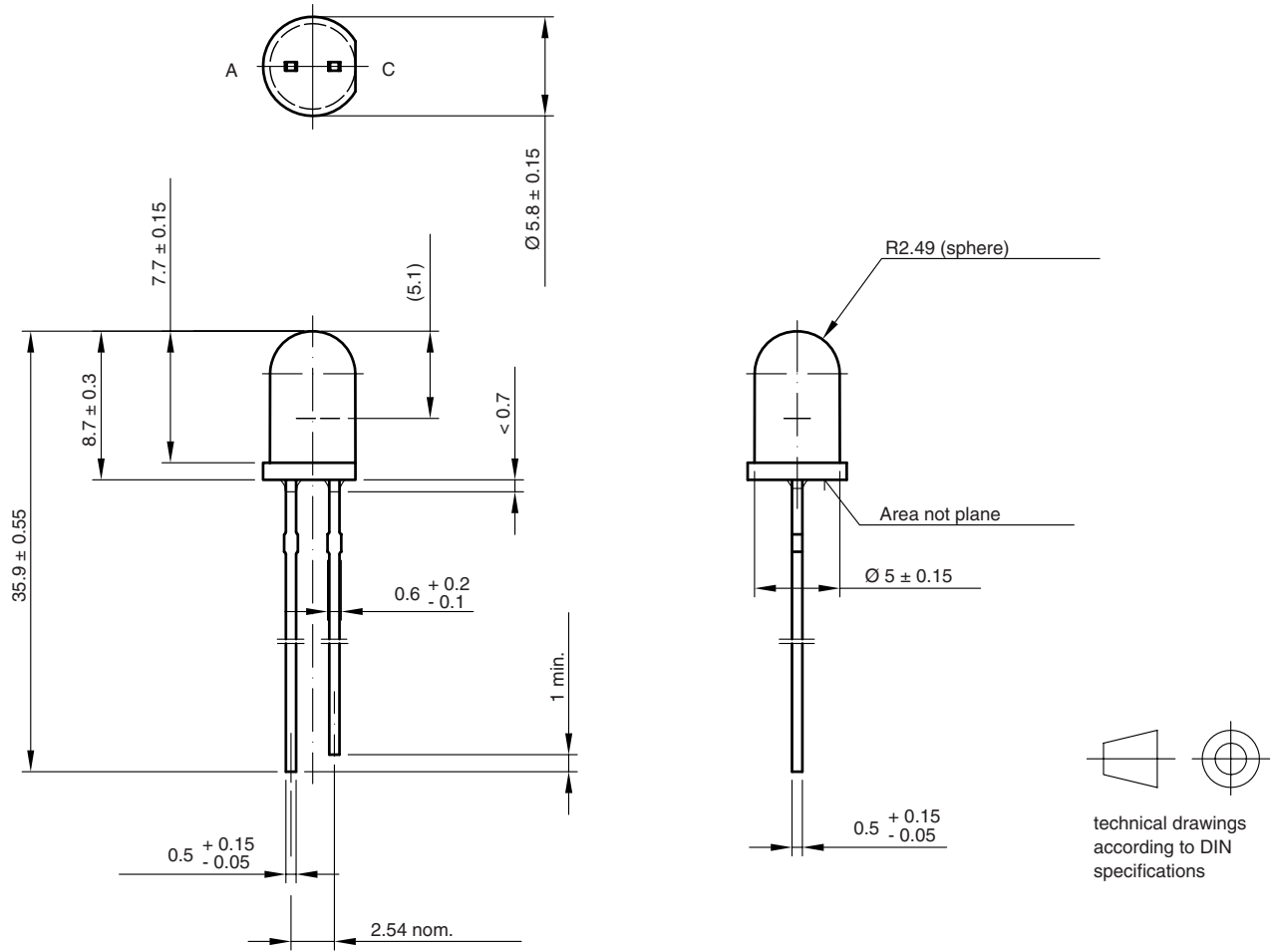

Drawing-No.: 6.544-5259.04-4  
Issue: 8; 19.05.09  
96 12125



## Disclaimer

ALL PRODUCT, PRODUCT SPECIFICATIONS AND DATA ARE SUBJECT TO CHANGE WITHOUT NOTICE TO IMPROVE RELIABILITY, FUNCTION OR DESIGN OR OTHERWISE.

Vishay Intertechnology, Inc., its affiliates, agents, and employees, and all persons acting on its or their behalf (collectively, "Vishay"), disclaim any and all liability for any errors, inaccuracies or incompleteness contained in any datasheet or in any other disclosure relating to any product.

Vishay makes no warranty, representation or guarantee regarding the suitability of the products for any particular purpose or the continuing production of any product. To the maximum extent permitted by applicable law, Vishay disclaims (i) any and all liability arising out of the application or use of any product, (ii) any and all liability, including without limitation special, consequential or incidental damages, and (iii) any and all implied warranties, including warranties of fitness for particular purpose, non-infringement and merchantability.

Statements regarding the suitability of products for certain types of applications are based on Vishay's knowledge of typical requirements that are often placed on Vishay products in generic applications. Such statements are not binding statements about the suitability of products for a particular application. It is the customer's responsibility to validate that a particular product with the properties described in the product specification is suitable for use in a particular application. Parameters provided in datasheets and/or specifications may vary in different applications and performance may vary over time. All operating parameters, including typical parameters, must be validated for each customer application by the customer's technical experts. Product specifications do not expand or otherwise modify Vishay's terms and conditions of purchase, including but not limited to the warranty expressed therein.

Except as expressly indicated in writing, Vishay products are not designed for use in medical, life-saving, or life-sustaining applications or for any other application in which the failure of the Vishay product could result in personal injury or death. Customers using or selling Vishay products not expressly indicated for use in such applications do so at their own risk and agree to fully indemnify and hold Vishay and its distributors harmless from and against any and all claims, liabilities, expenses and damages arising or resulting in connection with such use or sale, including attorneys fees, even if such claim alleges that Vishay or its distributor was negligent regarding the design or manufacture of the part. Please contact authorized Vishay personnel to obtain written terms and conditions regarding products designed for such applications.

No license, express or implied, by estoppel or otherwise, to any intellectual property rights is granted by this document or by any conduct of Vishay. Product names and markings noted herein may be trademarks of their respective owners.

Компания «Life Electronics» занимается поставками электронных компонентов импортного и отечественного производства от производителей и со складов крупных дистрибьюторов Европы, Америки и Азии.

С конца 2013 года компания активно расширяет линейку поставок компонентов по направлению коаксиальный кабель, кварцевые генераторы и конденсаторы (керамические, пленочные, электролитические), за счёт заключения дистрибьюторских договоров

Мы предлагаем:

- Конкурентоспособные цены и скидки постоянным клиентам.
- Специальные условия для постоянных клиентов.
- Подбор аналогов.
- Поставку компонентов в любых объемах, удовлетворяющих вашим потребностям.
- Приемлемые сроки поставки, возможна ускоренная поставка.
- Доставку товара в любую точку России и стран СНГ.
- Комплексную поставку.
- Работу по проектам и поставку образцов.
- Формирование склада под заказчика.
- Сертификаты соответствия на поставляемую продукцию (по желанию клиента).
- Тестирование поставляемой продукции.
- Поставку компонентов, требующих военную и космическую приемку.
- Входной контроль качества.
- Наличие сертификата ISO.

В составе нашей компании организован Конструкторский отдел, призванный помогать разработчикам, и инженерам.

Конструкторский отдел помогает осуществить:

- Регистрацию проекта у производителя компонентов.
- Техническую поддержку проекта.
- Защиту от снятия компонента с производства.
- Оценку стоимости проекта по компонентам.
- Изготовление тестовой платы монтаж и пусконаладочные работы.



Тел: +7 (812) 336 43 04 (многоканальный)

Email: [org@lifeelectronics.ru](mailto:org@lifeelectronics.ru)