

Single/Dual/Quad 100MHz,
 Rail-to-Rail Input and Output,
 Ultralow $1.9\text{nV}/\sqrt{\text{Hz}}$ Noise, Low Power Op Amps

FEATURES

- Low Noise Voltage: $1.9\text{nV}/\sqrt{\text{Hz}}$ (100kHz)
- Low Supply Current: 3mA/Amp Max
- Gain Bandwidth Product: 100MHz
- Dual LT6203 in Tiny DFN Package
- Low Distortion: -80dB at 1MHz
- Low Offset Voltage: 500 μV Max
- Wide Supply Range: 2.5V to 12.6V
- Input Common Mode Range Includes Both Rails
- Output Swings Rail-to-Rail
- Common Mode Rejection Ratio 90dB Typ
- Unity Gain Stable
- Low Noise Current: $1.1\text{pA}/\sqrt{\text{Hz}}$
- Output Current: 30mA Min
- Operating Temperature Range -40°C to 125°C
- Low Profile (1mm) SOT-23 (ThinSOT™) Package

APPLICATIONS

- Low Noise, Low Power Signal Processing
- Active Filters
- Rail-to-Rail Buffer Amplifiers
- Driving A/D Converters
- DSL Receivers
- Battery Powered/Battery Backed Equipment

DESCRIPTION

The LT®6202/LT6203/LT6204 are single/dual/quad low noise, rail-to-rail input and output unity gain stable op amps that feature $1.9\text{nV}/\sqrt{\text{Hz}}$ noise voltage and draw only 2.5mA of supply current per amplifier. These amplifiers combine very low noise and supply current with a 100MHz gain bandwidth product, a 25V/ μs slew rate, and are optimized for low supply signal conditioning systems.

These amplifiers maintain their performance for supplies from 2.5V to 12.6V and are specified at 3V, 5V and $\pm 5\text{V}$ supplies. Harmonic distortion is less than -80dBc at 1MHz making these amplifiers suitable in low power data acquisition systems.

The LT6202 is available in the 5-pin TSOT-23 and the 8-pin SO, while the LT6203 comes in 8-pin SO and MSOP packages with standard op amp pinouts. For compact layouts the LT6203 is also available in a tiny fine line leadless package (DFN), while the quad LT6204 is available in the 16-pin SSOP and 14-pin SO packages. These devices can be used as plug-in replacements for many op amps to improve input/output range and noise performance.

LT, LT, LTC, LTM, Linear Technology and the Linear logo are registered trademarks of Linear Technology Corporation. ThinSOT is a trademark of Linear Technology Corporation. All other trademarks are the property of their respective owners.

TYPICAL APPLICATION

Low Noise 4- to 2-Wire Local Echo Cancellation Differential Receiver

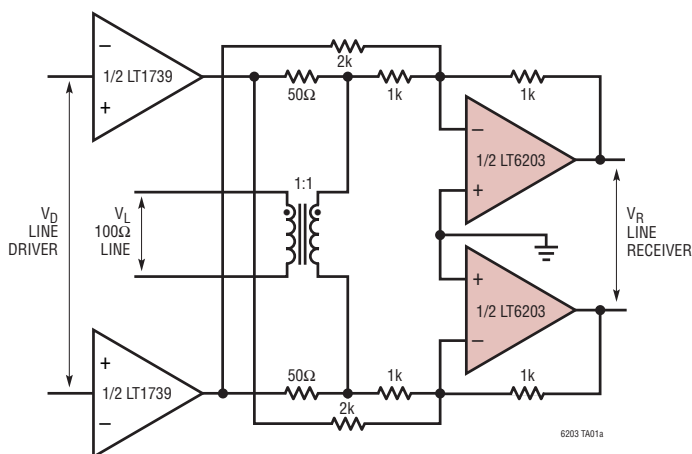

Line Receiver Integrated Noise 25kHz to 150kHz

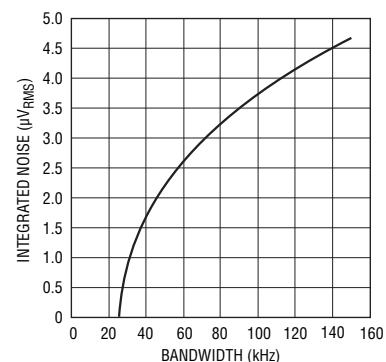

6203 TA01b

LT6202/LT6203/LT6204

ABSOLUTE MAXIMUM RATINGS (Note 1)

| | | | |
|---|--|---|--|
| Total Supply Voltage (V^+ to V^-) | 12.6V | Specified Temperature Range (Note 4) | |
| Input Current (Note 2)..... | $\pm 40\text{mA}$ | LT6202C/LT6203C/LT6204C..... | 0°C to 70°C |
| Output Short-Circuit Duration (Note 3) | Indefinite | LT6202I/LT6203I/LT6204I | -40°C to 85°C |
| Operating Temperature Range (Note 4) | | LT6202H/LT6203H..... | -40°C to 125°C |
| LT6202C/LT6203C/LT6204C..... | -40°C to 85°C | Junction Temperature | 150°C |
| LT6202I/LT6203I/LT6204I | -40°C to 85°C | Storage Temperature Range | -65°C to 150°C |
| LT6202H/LT6203H..... | -40°C to 125°C | Lead Temperature (Soldering, 10 sec)..... | 300°C |

PIN CONFIGURATION

| | | | |
|---|--|--|---|
| <p>LT6202</p> <p>TOP VIEW</p> <p>S5 PACKAGE 5-LEAD PLASTIC TSOT-23 $T_{JMAX} = 150^\circ\text{C}$, $\theta_{JA} = 160^\circ\text{C/W}$</p> | <p>LT6202</p> <p>TOP VIEW</p> <p>S8 PACKAGE 8-LEAD PLASTIC SO $T_{JMAX} = 150^\circ\text{C}$, $\theta_{JA} = 190^\circ\text{C/W}$</p> | <p>LT6203</p> <p>TOP VIEW</p> <p>DD PACKAGE 8-LEAD (3mm x 3mm) PLASTIC DFN $T_{JMAX} = 150^\circ\text{C}$, $\theta_{JA} = 43^\circ\text{C/W}$ UNDERSIDE METAL CONNECTED TO V^-</p> | <p>LT6203</p> <p>TOP VIEW</p> <p>MS8 PACKAGE 8-LEAD PLASTIC MSOP $T_{JMAX} = 150^\circ\text{C}$, $\theta_{JA} = 250^\circ\text{C/W}$</p> |
| <p>LT6203</p> <p>TOP VIEW</p> <p>S8 PACKAGE 8-LEAD PLASTIC SO $T_{JMAX} = 150^\circ\text{C}$, $\theta_{JA} = 190^\circ\text{C/W}$</p> | <p>LT6204</p> <p>TOP VIEW</p> <p>GN PACKAGE 16-LEAD NARROW PLASTIC SSOP $T_{JMAX} = 150^\circ\text{C}$, $\theta_{JA} = 135^\circ\text{C/W}$</p> | <p>LT6204</p> <p>TOP VIEW</p> <p>S PACKAGE 14-LEAD PLASTIC SO $T_{JMAX} = 150^\circ\text{C}$, $\theta_{JA} = 150^\circ\text{C/W}$</p> | |

ORDER INFORMATION

| LEAD FREE FINISH | TAPE AND REEL | PART MARKING* | PACKAGE DESCRIPTION | SPECIFIED TEMPERATURE RANGE |
|------------------|------------------|---------------|--------------------------------|-----------------------------|
| LT6202CS5#PBF | LT6202CS5#TRPBF | LTG6 | 5-Lead Plastic TSOT-23 | 0°C to 70°C |
| LT6202IS5#PBF | LT6202IS5#TRPBF | LTG6 | 5-Lead Plastic TSOT-23 | -40°C to 85°C |
| LT6202HS5#PBF | LT6202HS5#TRPBF | LTG6 | 5-Lead Plastic TSOT-23 | -40°C to 125°C |
| LT6202CS8#PBF | LT6202CS8#TRPBF | 6202 | 8-Lead Plastic SO | 0°C to 70°C |
| LT6202IS8#PBF | LT6202IS8#TRPBF | 6202I | 8-Lead Plastic SO | -40°C to 85°C |
| LT6203CDD#PBF | LT6203CDD#TRPBF | LAAP | 8-Lead (3mm × 3mm) Plastic DFN | 0°C to 70°C |
| LT6203IDD#PBF | LT6203IDD#TRPBF | LAAP | 8-Lead (3mm × 3mm) Plastic DFN | -40°C to 85°C |
| LT6203CMS8#PBF | LT6203CMS8#TRPBF | LTB2 | 8-Lead Plastic MSOP | 0°C to 70°C |
| LT6203IMS8#PBF | LT6203IMS8#TRPBF | LTB3 | 8-Lead Plastic MSOP | -40°C to 85°C |
| LT6203HMS8#PBF | LT6203HMS8#TRPBF | LTB3 | 8-Lead Plastic MSOP | -40°C to 125°C |
| LT6203CS8#PBF | LT6203CS8#TRPBF | 6203 | 8-Lead Plastic SO | 0°C to 70°C |
| LT6203IS8#PBF | LT6203IS8#TRPBF | 6203I | 8-Lead Plastic SO | -40°C to 85°C |
| LT6204CGN#PBF | LT6204CGN#TRPBF | 6204 | 16-Lead Narrow Plastic SSOP | 0°C to 70°C |
| LT6204IGN#PBF | LT6204IGN#TRPBF | 6204I | 16-Lead Narrow Plastic SSOP | -40°C to 85°C |
| LT6204CS#PBF | LT6204CS#TRPBF | LT6204CS | 14-Lead Plastic SO | 0°C to 70°C |
| LT6204IS#PBF | LT6204IS#TRPBF | LT6204IS | 14-Lead Plastic SO | -40°C to 85°C |

Consult LTC Marketing for parts specified with wider operating temperature ranges. *The temperature grade is identified by a label on the shipping container. Consult LTC Marketing for information on non-standard lead based finish parts.

For more information on lead free part marking, go to: <http://www.linear.com/leadfree/>

For more information on tape and reel specifications, go to: <http://www.linear.com/tapeandree/>

LT6202/LT6203/LT6204

ELECTRICAL CHARACTERISTICS

$T_A = 25^\circ\text{C}$, $V_S = 5\text{V}, 0\text{V}$; $V_S = 3\text{V}, 0\text{V}$; $V_{CM} = V_{OUT} = \text{half supply}$,

unless otherwise noted.

| SYMBOL | PARAMETER | CONDITIONS | MIN | TYP | MAX | UNITS |
|--------------|--|--|--|--------------|------------|------------------------|
| V_{OS} | Input Offset Voltage | $V_S = 5\text{V}, 0\text{V}, V_{CM} = \text{Half Supply}$ LT6203, LT6204, LT6202S8 LT6202 TSOT-23 | | 0.1 0.1 | 0.5 0.7 | mV mV |
| | | $V_S = 3\text{V}, 0\text{V}, V_{CM} = \text{Half Supply}$ LT6203, LT6204, LT6202S8 LT6202 TSOT-23 | | 0.6 0.6 | 1.5 1.7 | mV mV |
| | | $V_S = 5\text{V}, 0\text{V}, V_{CM} = V^+ \text{ to } V^-$ LT6203, LT6204, LT6202S8 LT6202 TSOT-23 | | 0.25 0.25 | 2.0 2.2 | mV mV |
| | | $V_S = 3\text{V}, 0\text{V}, V_{CM} = V^+ \text{ to } V^-$ LT6203, LT6204, LT6202S8 LT6202 TSOT-23 | | 1.0 1.0 | 3.5 3.7 | mV mV |
| | Input Offset Voltage Match (Channel-to-Channel) (Note 5) | $V_{CM} = \text{Half Supply}$ $V_{CM} = V^- \text{ to } V^+$ | | 0.15 0.3 | 0.8 1.8 | mV mV |
| I_B | Input Bias Current | $V_{CM} = \text{Half Supply}$ | -7.0 | -1.3 | | μA |
| | | $V_{CM} = V^+$ | | 1.3 | 2.5 | μA |
| | | $V_{CM} = V^-$ | -8.8 | -3.3 | | μA |
| ΔI_B | I_B Shift | $V_{CM} = V^- \text{ to } V^+$ | | 4.7 | 11.3 | μA |
| | I_B Match (Channel-to-Channel) (Note 5) | | | 0.1 | 0.6 | μA |
| I_{OS} | Input Offset Current | $V_{CM} = \text{Half Supply}$ | | 0.12 | 1 | μA |
| | | $V_{CM} = V^+$ | | 0.07 | 1 | μA |
| | | $V_{CM} = V^-$ | | 0.12 | 1.1 | μA |
| | Input Noise Voltage | 0.1Hz to 10Hz | | 800 | | nV _{p-p} |
| e_n | Input Noise Voltage Density | $f = 100\text{kHz}, V_S = 5\text{V}$ | | 2 | | nV/ $\sqrt{\text{Hz}}$ |
| | | $f = 10\text{kHz}, V_S = 5\text{V}$ | | 2.9 | 4.5 | nV/ $\sqrt{\text{Hz}}$ |
| i_n | Input Noise Current Density, Balanced Input Noise Current Density, Unbalanced | $f = 10\text{kHz}, V_S = 5\text{V}$ | | 0.75 | | pA/ $\sqrt{\text{Hz}}$ |
| | | | | 1.1 | | pA/ $\sqrt{\text{Hz}}$ |
| C_{IN} | Input Capacitance | Common Mode | | 4 | | M Ω |
| | | Differential Mode | | 12 | | k Ω |
| A_{VOL} | Large Signal Gain | $V_S = 5\text{V}, V_O = 0.5\text{V to } 4.5\text{V}, R_L = 1\text{k to } V_S/2$ | 40 | 70 | | V/mV |
| | | $V_S = 5\text{V}, V_O = 1\text{V to } 4\text{V}, R_L = 100 \text{ to } V_S/2$ $V_S = 3\text{V}, V_O = 0.5\text{V to } 2.5\text{V}, R_L = 1\text{k to } V_S/2$ | 8.0 17 | 14 40 | | V/mV V/mV |
| CMRR | Common Mode Rejection Ratio | $V_S = 5\text{V}, V_{CM} = V^- \text{ to } V^+$ | 60 | 83 | | dB |
| | | $V_S = 5\text{V}, V_{CM} = 1.5\text{V to } 3.5\text{V}$ | 80 | 100 | | dB |
| | | $V_S = 3\text{V}, V_{CM} = V^- \text{ to } V^+$ | 56 | 80 | | dB |
| | CMRR Match (Channel-to-Channel) (Note 5) | $V_S = 5\text{V}, V_{CM} = 1.5\text{V to } 3.5\text{V}$ | 85 | 120 | | dB |
| PSRR | Power Supply Rejection Ratio | $V_S = 2.5\text{V to } 10\text{V}, V_{CM} = 0\text{V}$ | 60 | 74 | | dB |
| | | PSRR Match (Channel-to-Channel) (Note 5) | $V_S = 2.5\text{V to } 10\text{V}, V_{CM} = 0\text{V}$ | 70 | 100 | |
| | Minimum Supply Voltage (Note 6) | | 2.5 | | | V |
| V_{OL} | Output Voltage Swing LOW Saturation (Note 7) | No Load | | 5 | 50 | mV |
| | | $I_{SINK} = 5\text{mA}$ | | 85 | 190 | mV |
| | | $V_S = 5\text{V}, I_{SINK} = 20\text{mA}$ | | 240 | 460 | mV |
| | | $V_S = 3\text{V}, I_{SINK} = 15\text{mA}$ | | 185 | 350 | mV |
| V_{OH} | Output Voltage Swing HIGH Saturation (Note 7) | No Load | | 25 | 75 | mV |
| | | $I_{SOURCE} = 5\text{mA}$ | | 90 | 210 | mV |
| | | $V_S = 5\text{V}, I_{SOURCE} = 20\text{mA}$ | | 325 | 600 | mV |
| | | $V_S = 3\text{V}, I_{SOURCE} = 15\text{mA}$ | | 225 | 410 | mV |

620234fd

ELECTRICAL CHARACTERISTICS $T_A = 25^\circ\text{C}$, $V_S = 5\text{V}, 0\text{V}$; $V_S = 3\text{V}, 0\text{V}$; $V_{CM} = V_{OUT} = \text{half supply}$, unless otherwise noted.

| SYMBOL | PARAMETER | CONDITIONS | MIN | TYP | MAX | UNITS |
|----------|-------------------------------|---|----------|----------|------|------------------|
| I_{SC} | Short-Circuit Current | $V_S = 5\text{V}$ | ± 30 | ± 45 | | mA |
| | | $V_S = 3\text{V}$ | ± 25 | ± 40 | | mA |
| I_S | Supply Current per Amp | $V_S = 5\text{V}$ | | 2.5 | 3.0 | mA |
| | | $V_S = 3\text{V}$ | | 2.3 | 2.85 | mA |
| GBW | Gain Bandwidth Product | Frequency = 1MHz, $V_S = 5\text{V}$ | | 90 | | MHz |
| SR | Slew Rate | $V_S = 5\text{V}$, $A_V = -1$, $R_L = 1\text{k}$, $V_O = 4\text{V}$ | 17 | 24 | | V/ μs |
| FPBW | Full Power Bandwidth (Note 9) | $V_S = 5\text{V}$, $V_{OUT} = 3V_{P-P}$ | 1.8 | 2.5 | | MHz |
| t_S | Settling Time | 0.1%, $V_S = 5\text{V}$, $V_{STEP} = 2\text{V}$, $A_V = -1$, $R_L = 1\text{k}$ | | 85 | | ns |

The ● denotes the specifications which apply over $0^\circ\text{C} < T_A < 70^\circ\text{C}$ temperature range. $V_S = 5\text{V}, 0\text{V}$; $V_S = 3\text{V}, 0\text{V}$; $V_{CM} = V_{OUT} = \text{half supply}$, unless otherwise noted.

| SYMBOL | PARAMETER | CONDITIONS | MIN | TYP | MAX | UNITS | |
|--------------|--|---|---|------|------|------------------------------|----|
| V_{OS} | Input Offset Voltage | $V_S = 5\text{V}, 0\text{V}$, $V_{CM} = \text{Half Supply}$ LT6203, LT6204, LT6202S8 | ● | 0.2 | 0.7 | mV | |
| | | LT6202 TSOT-23 | ● | 0.2 | 0.9 | mV | |
| | | $V_S = 3\text{V}, 0\text{V}$, $V_{CM} = \text{Half Supply}$ LT6203, LT6204, LT6202S8 | ● | 0.6 | 1.7 | mV | |
| | | LT6202 TSOT-23 | ● | 0.6 | 1.9 | mV | |
| $V_{OS\ TC}$ | Input Offset Voltage Drift (Note 8) | $V_S = 5\text{V}, 0\text{V}$, $V_{CM} = V^+ \text{ to } V^-$ LT6203, LT6204, LT6202S8 | ● | 0.7 | 2.5 | mV | |
| | | LT6202 TSOT-23 | ● | 0.7 | 2.7 | mV | |
| | | $V_S = 3\text{V}, 0\text{V}$, $V_{CM} = V^+ \text{ to } V^-$ LT6203, LT6204, LT6202S8 | ● | 1.2 | 4.0 | mV | |
| | | LT6202 TSOT-23 | ● | 1.2 | 4.2 | mV | |
| $V_{OS\ TC}$ | Input Offset Voltage Match (Channel-to-Channel) (Note 5) | $V_{CM} = \text{Half Supply}$ | ● | 3.0 | 9.0 | $\mu\text{V}/^\circ\text{C}$ | |
| | | $V_{CM} = V^- \text{ to } V^+$ | ● | 0.15 | 0.9 | mV | |
| I_B | Input Bias Current | $V_{CM} = \text{Half Supply}$ | ● | -7.0 | -1.3 | μA | |
| | | $V_{CM} = V^+$ | ● | | 1.3 | μA | |
| | | $V_{CM} = V^-$ | ● | -8.8 | -3.3 | μA | |
| ΔI_B | I_B Shift | $V_{CM} = V^- \text{ to } V^+$ | ● | 4.7 | 11.3 | μA | |
| | I_B Match (Channel-to-Channel) (Note 5) | | ● | 0.1 | 0.6 | μA | |
| I_{OS} | Input Offset Current | $V_{CM} = \text{Half Supply}$ | ● | 0.15 | 1 | μA | |
| | | $V_{CM} = V^+$ | ● | 0.10 | 1 | μA | |
| | | $V_{CM} = V^-$ | ● | 0.15 | 1.1 | μA | |
| A_{VOL} | Large Signal Gain | $V_S = 5\text{V}$, $V_O = 0.5\text{V to } 4.5\text{V}$, $R_L = 1\text{k to } V_S/2$ | ● | 35 | 60 | V/mV | |
| | | $V_S = 5\text{V}$, $V_O = 1.5\text{V to } 3.5\text{V}$, $R_L = 100 \text{ to } V_S/2$ | ● | 6.0 | 12 | V/mV | |
| | | $V_S = 3\text{V}$, $V_O = 0.5\text{V to } 2.5\text{V}$, $R_L = 1\text{k to } V_S/2$ | ● | 15 | 36 | V/mV | |
| CMRR | Common Mode Rejection Ratio | $V_S = 5\text{V}$, $V_{CM} = V^- \text{ to } V^+$ | ● | 60 | 83 | dB | |
| | | $V_S = 5\text{V}$, $V_{CM} = 1.5\text{V to } 3.5\text{V}$ | ● | 78 | 97 | dB | |
| | | $V_S = 3\text{V}$, $V_{CM} = V^- \text{ to } V^+$ | ● | 56 | 75 | dB | |
| | CMRR Match (Channel-to-Channel) (Note 5) | $V_S = 5\text{V}$, $V_{CM} = 1.5\text{V to } 3.5\text{V}$ | ● | 83 | 100 | dB | |
| PSRR | Power Supply Rejection Ratio | $V_S = 3\text{V to } 10\text{V}$, $V_{CM} = 0\text{V}$ | ● | 60 | 70 | dB | |
| | | PSRR Match (Channel-to-Channel) (Note 5) | $V_S = 3\text{V to } 10\text{V}$, $V_{CM} = 0\text{V}$ | ● | 70 | 100 | dB |
| | | Minimum Supply Voltage (Note 6) | ● | 3.0 | | V | |
| V_{OL} | Output Voltage Swing LOW Saturation (Note 7) | No Load | ● | 5.0 | 60 | mV | |
| | | $I_{SINK} = 5\text{mA}$ | ● | 95 | 200 | mV | |
| | | $I_{SINK} = 15\text{mA}$ | ● | 260 | 365 | mV | |

LT6202/LT6203/LT6204

ELECTRICAL CHARACTERISTICS

The ● denotes the specifications which apply over 0°C < T_A < 70°C temperature range. V_S = 5V, 0V; V_S = 3V, 0V; V_{CM} = V_{OUT} = half supply, unless otherwise noted.

| SYMBOL | PARAMETER | CONDITIONS | MIN | TYP | MAX | UNITS |
|-----------------|---|--|-----|------|------|-------|
| V _{OH} | Output Voltage Swing HIGH Saturation (Note 7) | No Load | ● | 50 | 100 | mV |
| | | I _{SOURCE} = 5mA | ● | 115 | 230 | mV |
| | | V _S = 5V, I _{SOURCE} = 20mA | ● | 360 | 635 | mV |
| | | V _S = 3V, I _{SOURCE} = 15mA | ● | 260 | 430 | mV |
| I _{SC} | Short-Circuit Current | V _S = 5V | ● | ±20 | ±33 | mA |
| | | V _S = 3V | ● | ±20 | ±30 | mA |
| I _S | Supply Current per Amp | V _S = 5V | ● | 3.1 | 3.85 | mA |
| | | V _S = 3V | ● | 2.75 | 3.50 | mA |
| GBW | Gain Bandwidth Product | Frequency = 1MHz | ● | 87 | | MHz |
| SR | Slew Rate | V _S = 5V, A _V = -1, R _L = 1k, V _O = 4V | ● | 15 | 21 | V/μs |
| FPBW | Full Power Bandwidth (Note 9) | V _S = 5V, V _{OUT} = 3V _{P-P} | ● | 1.6 | 2.2 | MHz |

The ● denotes the specifications which apply over -40°C < T_A < 85°C temperature range. V_S = 5V, 0V; V_S = 3V, 0V; V_{CM} = V_{OUT} = half supply, unless otherwise noted. (Note 4)

| SYMBOL | PARAMETER | CONDITIONS | MIN | TYP | MAX | UNITS | |
|--------------------|--|---|-----|------|------|-------|----|
| V _{OS} | Input Offset Voltage | V _S = 5V, 0V, V _{CM} = Half Supply LT6203, LT6204, LT6202S8 | ● | 0.2 | 0.8 | mV | |
| | | LT6202 TSOT-23 | ● | 0.2 | 1.0 | mV | |
| | | V _S = 3V, 0V, V _{CM} = Half Supply LT6203, LT6204, LT6202S8 | ● | 0.6 | 2.0 | mV | |
| | | LT6202 TSOT-23 | ● | 0.6 | 2.2 | mV | |
| | | V _S = 5V, 0V, V _{CM} = V ⁺ to V ⁻ LT6203, LT6204, LT6202S8 | ● | 1.0 | 3.0 | mV | |
| | | LT6202 TSOT-23 | ● | 1.0 | 3.5 | mV | |
| | | V _S = 3V, 0V, V _{CM} = V ⁺ to V ⁻ LT6203, LT6204, LT6202S8 | ● | 1.4 | 4.5 | mV | |
| | | LT6202 TSOT-23 | ● | 1.4 | 4.7 | mV | |
| V _{OS TC} | Input Offset Voltage Drift (Note 8) | V _{CM} = Half Supply | ● | 3.0 | 9.0 | μV/°C | |
| | | | | | | | |
| | Input Offset Voltage Match (Channel-to-Channel) (Note 5) | V _{CM} = Half Supply | ● | 0.3 | 1.0 | mV | |
| | | V _{CM} = V ⁻ to V ⁺ | ● | 0.7 | 2.5 | mV | |
| I _B | Input Bias Current | V _{CM} = Half Supply | ● | -7.0 | -1.3 | μA | |
| | | V _{CM} = V ⁺ | ● | | 1.3 | 2.5 | μA |
| | | V _{CM} = V ⁻ | ● | -8.8 | -3.3 | | μA |
| ΔI _B | I _B Shift | V _{CM} = V ⁻ to V ⁺ | ● | | 4.7 | 11.3 | μA |
| | | | ● | | 0.1 | 0.6 | μA |
| I _{OS} | Input Offset Current | V _{CM} = Half Supply | ● | 0.2 | 1 | μA | |
| | | V _{CM} = V ⁺ | ● | 0.2 | 1.1 | μA | |
| | | V _{CM} = V ⁻ | ● | 0.2 | 1.2 | μA | |
| A _{VOL} | Large Signal Gain | V _S = 5V, V _O = 0.5V to 4.5V, R _L = 1k to V _S /2 | ● | 32 | 60 | V/mV | |
| | | V _S = 5V, V _O = 1.5V to 3.5V, R _L = 100 to V _S /2 | ● | 4.0 | 10 | V/mV | |
| | | V _S = 3V, V _O = 0.5V to 2.5V, R _L = 1k to V _S /2 | ● | 13 | 32 | V/mV | |
| CMRR | Common Mode Rejection Ratio | V _S = 5V, V _{CM} = V ⁻ to V ⁺ | ● | 60 | 80 | dB | |
| | | V _S = 5V, V _{CM} = 1.5V to 3.5V | ● | 75 | 95 | dB | |
| | | V _S = 3V, V _{CM} = V ⁻ to V ⁺ | ● | 56 | 75 | dB | |
| | CMRR Match (Channel-to-Channel) (Note 5) | V _S = 5V, V _{CM} = 1.5V to 3.5V | ● | 80 | 100 | dB | |
| PSRR | Power Supply Rejection Ratio | V _S = 3V to 10V, V _{CM} = 0V | ● | 60 | 70 | dB | |
| | | | ● | 70 | 100 | dB | |
| | Minimum Supply Voltage (Note 6) | | ● | 3.0 | | V | |

620234fd

ELECTRICAL CHARACTERISTICS The ● denotes the specifications which apply over $-40^{\circ}\text{C} < T_A < 85^{\circ}\text{C}$ temperature range. $V_S = 5\text{V}, 0\text{V}; V_S = 3\text{V}, 0\text{V}; V_{CM} = V_{OUT} = \text{half supply}$, unless otherwise noted. (Note 4)

| SYMBOL | PARAMETER | CONDITIONS | MIN | TYP | MAX | UNITS |
|----------|---|---|-----|----------|----------|------------------|
| V_{OL} | Output Voltage Swing LOW Saturation (Note 7) | No Load | ● | 6 | 70 | mV |
| | | $I_{SINK} = 5\text{mA}$ | ● | 95 | 210 | mV |
| | | $I_{SINK} = 15\text{mA}$ | ● | 210 | 400 | mV |
| V_{OH} | Output Voltage Swing HIGH Saturation (Note 7) | No Load | ● | 55 | 110 | mV |
| | | $I_{SOURCE} = 5\text{mA}$ | ● | 125 | 240 | mV |
| | | $V_S = 5\text{V}, I_{SOURCE} = 15\text{mA}$ | ● | 370 | 650 | mV |
| | | $V_S = 3\text{V}, I_{SOURCE} = 15\text{mA}$ | ● | 270 | 650 | mV |
| I_{SC} | Short-Circuit Current | $V_S = 5\text{V}$ | ● | ± 15 | ± 25 | mA |
| | | $V_S = 3\text{V}$ | ● | ± 15 | ± 23 | mA |
| I_S | Supply Current per Amp | $V_S = 5\text{V}$ | ● | 3.3 | 4.1 | mA |
| | | $V_S = 3\text{V}$ | ● | 3.0 | 3.65 | mA |
| GBW | Gain Bandwidth Product | Frequency = 1MHz | ● | 83 | | MHz |
| SR | Slew Rate | $V_S = 5\text{V}, A_V = -1, R_L = 1\text{k}, V_O = 4\text{V}$ | ● | 12 | 17 | V/ μs |
| FPBW | Full Power Bandwidth (Note 9) | $V_S = 5\text{V}, V_{OUT} = 3V_{P-P}$ | ● | 1.3 | 1.8 | MHz |

The ● denotes the specifications which apply over $-40^{\circ}\text{C} < T_A < 125^{\circ}\text{C}$ temperature range. $V_S = 5\text{V}, 0\text{V}; V_S = 3\text{V}, 0\text{V}; V_{CM} = V_{OUT} = \text{half supply}$, unless otherwise noted. (Note 4)

| SYMBOL | PARAMETER | CONDITIONS | MIN | TYP | MAX | UNITS |
|--------------|---|---|-------------------------------|------|------|--------------------------------|
| V_{OS} | Input Offset Voltage | $V_S = 5\text{V}, 0\text{V}, V_{CM} = \text{Half Supply}$ LT6203 | ● | 0.2 | 1.3 | mV |
| | | | ● | 0.2 | 1.4 | mV |
| | | $V_S = 3\text{V}, 0\text{V}, V_{CM} = \text{Half Supply}$ LT6203 | ● | 0.6 | 2.0 | mV |
| | | | ● | 0.6 | 2.2 | mV |
| | | $V_S = 5\text{V}, 0\text{V}, V_{CM} = V^+ \text{ to } V^-$ LT6203 | ● | 1.0 | 4.0 | mV |
| | | | ● | 1.0 | 4.3 | mV |
| | | $V_S = 3\text{V}, 0\text{V}, V_{CM} = V^+ \text{ to } V^-$ LT6203 | ● | 1.4 | 4.5 | mV |
| | | | ● | 1.4 | 4.7 | mV |
| $V_{OS\ TC}$ | Input Offset Voltage Drift (Note 8) | $V_{CM} = \text{Half Supply}$ | ● | 3.0 | 9.0 | $\mu\text{V}/^{\circ}\text{C}$ |
| | | Input Offset Voltage Match (Channel-to-Channel) (Note 5) | $V_{CM} = \text{Half Supply}$ | ● | 0.3 | 1.3 |
| | $V_{CM} = V^- \text{ to } V^+$ | | ● | 0.7 | 3.0 | mV |
| I_B | Input Bias Current | $V_{CM} = \text{Half Supply}$ | ● | -7.4 | -1.3 | μA |
| | | $V_{CM} = V^+$ | ● | | 1.3 | μA |
| | | $V_{CM} = V^-$ | ● | -9.8 | -3.3 | μA |
| ΔI_B | I_B Shift | $V_{CM} = V^- \text{ to } V^+$ | ● | 4.7 | 12.3 | μA |
| | I_B Match (Channel-to-Channel) (Note 5) | | ● | 0.1 | 0.6 | μA |
| I_{OS} | Input Offset Current | $V_{CM} = \text{Half Supply}$ | ● | 0.2 | 1.1 | μA |
| | | $V_{CM} = V^+$ | ● | 0.2 | 1.2 | μA |
| | | $V_{CM} = V^-$ | ● | 0.2 | 1.3 | μA |
| A_{VOL} | Large Signal Gain | $V_S = 5\text{V}, V_O = 0.5\text{V to } 4.5\text{V}, R_L = 1\text{k to } V_S/2$ | ● | 29 | 60 | V/mV |
| | | $V_S = 5\text{V}, V_O = 1.5\text{V to } 3.5\text{V}, R_L = 100 \text{ to } V_S/2$ | ● | 3.7 | 10 | V/mV |
| | | $V_S = 3\text{V}, V_O = 0.5\text{V to } 2.5\text{V}, R_L = 1\text{k to } V_S/2$ | ● | 12 | 32 | V/mV |
| CMRR | Common Mode Rejection Ratio | $V_S = 5\text{V}, V_{CM} = V^- \text{ to } V^+$ | ● | 60 | 80 | dB |
| | | $V_S = 5\text{V}, V_{CM} = 1.5\text{V to } 3.5\text{V}$ | ● | 75 | 95 | dB |
| | | $V_S = 3\text{V}, V_{CM} = V^- \text{ to } V^+$ | ● | 56 | 75 | dB |
| | CMRR Match (Channel-to-Channel) (Note 5) | $V_S = 5\text{V}, V_{CM} = 1.5\text{V to } 3.5\text{V}$ | ● | 80 | 100 | dB |
| PSRR | Power Supply Rejection Ratio | $V_S = 3\text{V to } 10\text{V}, V_{CM} = 0\text{V}$ | ● | 60 | 70 | dB |

LT6202/LT6203/LT6204

ELECTRICAL CHARACTERISTICS

The ● denotes the specifications which apply over $-40^{\circ}\text{C} < T_A < 125^{\circ}\text{C}$ temperature range. $V_S = 5\text{V}, 0\text{V}; V_S = 3\text{V}, 0\text{V}; V_{CM} = V_{OUT} = \text{half supply}$, unless otherwise noted. (Note 4)

| SYMBOL | PARAMETER | CONDITIONS | MIN | TYP | MAX | UNITS | |
|----------|---|---|-----|----------|----------|------------------|----|
| | PSRR Match (Channel-to-Channel) (Note 5) | $V_S = 3\text{V to } 10\text{V}, V_{CM} = 0\text{V}$ | ● | 70 | 100 | dB | |
| | Minimum Supply Voltage (Note 6) | | ● | 3.0 | | V | |
| V_{OL} | Output Voltage Swing LOW Saturation (Note 7) | No Load | ● | | 6 | 70 | mV |
| | | $I_{SINK} = 5\text{mA}$ | ● | | 95 | 220 | mV |
| | | $I_{SINK} = 15\text{mA}$ | ● | | 210 | 420 | mV |
| V_{OH} | Output Voltage Swing HIGH Saturation (Note 7) | No Load | ● | | 55 | 130 | mV |
| | | $I_{SOURCE} = 5\text{mA}$ | ● | | 125 | 255 | mV |
| | | $V_S = 5\text{V}, I_{SOURCE} = 15\text{mA}$ | ● | | 370 | 650 | mV |
| | | $V_S = 3\text{V}, I_{SOURCE} = 15\text{mA}$ | ● | | 270 | 670 | mV |
| I_{SC} | Short-Circuit Current | $V_S = 5\text{V}$ | ● | ± 15 | ± 25 | mA | |
| | | $V_S = 3\text{V}$ | ● | ± 15 | ± 23 | mA | |
| I_S | Supply Current per Amp | $V_S = 5\text{V}$ | ● | | 3.3 | 4.8 | mA |
| | | $V_S = 3\text{V}$ | ● | | 3.0 | 4.2 | mA |
| GBW | Gain Bandwidth Product | Frequency = 1MHz | ● | | 83 | MHz | |
| SR | Slew Rate | $V_S = 5\text{V}, A_V = -1, R_L = 1\text{k}, V_O = 4\text{V}$ | ● | 12 | 17 | V/ μs | |
| FPBW | Full Power Bandwidth (Note 9) | $V_S = 5\text{V}, V_{OUT} = 3V_{P-P}$ | ● | 1.3 | 1.8 | MHz | |

$T_A = 25^{\circ}\text{C}, V_S = \pm 5\text{V}; V_{CM} = V_{OUT} = 0\text{V}$, unless otherwise noted.

| SYMBOL | PARAMETER | CONDITIONS | MIN | TYP | MAX | UNITS | |
|--------------|--|--|----------------------|------|------|------------------------|---------------|
| V_{OS} | Input Offset Voltage | LT6203, LT6204, LT6202S8 | $V_{CM} = 0\text{V}$ | | 1.0 | 2.5 | mV |
| | | | $V_{CM} = V^+$ | | 2.6 | 5.5 | mV |
| | | | $V_{CM} = V^-$ | | 2.3 | 5.0 | mV |
| | | LT6202 SOT-23 | $V_{CM} = 0\text{V}$ | | 1.0 | 2.7 | mV |
| | | | $V_{CM} = V^+$ | | 2.6 | 6.0 | mV |
| | | | $V_{CM} = V^-$ | | 2.3 | 5.5 | mV |
| | Input Offset Voltage Match (Channel-to-Channel) (Note 5) | $V_{CM} = 0\text{V}$ | | 0.2 | 1.0 | mV | |
| | | $V_{CM} = V^- \text{ to } V^+$ | | 0.4 | 2.0 | mV | |
| I_B | Input Bias Current | $V_{CM} = \text{Half Supply}$ | | -7.0 | -1.3 | μA | |
| | | $V_{CM} = V^+$ | | | 1.3 | 3.0 | μA |
| | | $V_{CM} = V^-$ | | -9.5 | -3.8 | μA | |
| ΔI_B | I_B Shift | $V_{CM} = V^- \text{ to } V^+$ | | | 5.3 | 12.5 | μA |
| | I_B Match (Channel-to-Channel) (Note 5) | | | 0.1 | 0.6 | μA | |
| I_{OS} | Input Offset Current | $V_{CM} = \text{Half Supply}$ | | 0.15 | 1 | μA | |
| | | $V_{CM} = V^+$ | | 0.2 | 1.2 | μA | |
| | | $V_{CM} = V^-$ | | 0.35 | 1.3 | μA | |
| | Input Noise Voltage | 0.1Hz to 10Hz | | 800 | | nV $_{P-P}$ | |
| e_n | Input Noise Voltage Density | $f = 100\text{kHz}$ | | 1.9 | | nV/ $\sqrt{\text{Hz}}$ | |
| | | $f = 10\text{kHz}$ | | 2.8 | 4.5 | nV/ $\sqrt{\text{Hz}}$ | |
| i_n | Input Noise Current Density, Balanced Input Noise Current Density, Unbalanced | $f = 10\text{kHz}$ | | 0.75 | | pA/ $\sqrt{\text{Hz}}$ | |
| | | | | 1.1 | | pA/ $\sqrt{\text{Hz}}$ | |
| C_{IN} | Input Resistance | Common Mode | | 4 | | M Ω | |
| | | Differential Mode | | 12 | | k Ω | |
| C_{IN} | Input Capacitance | Common Mode | | 1.8 | | pF | |
| | | Differential Mode | | 1.5 | | pF | |
| A_{VOL} | Large Signal Gain | $V_O = \pm 4.5\text{V}, R_L = 1\text{k}$ | | 75 | 130 | V/mV | |
| | | $V_O = \pm 2.5\text{V}, R_L = 100$ | | 11 | 19 | V/mV | |

620234fd

ELECTRICAL CHARACTERISTICS $T_A = 25^\circ\text{C}$, $V_S = \pm 5\text{V}$; $V_{CM} = V_{OUT} = 0\text{V}$, unless otherwise noted.

| SYMBOL | PARAMETER | CONDITIONS | MIN | TYP | MAX | UNITS |
|----------|---|---|---|----------|-----|------------------|
| CMRR | Common Mode Rejection Ratio | $V_{CM} = V^-$ to V^+ | 65 | 85 | | dB |
| | | $V_{CM} = -2\text{V}$ to 2V | 85 | 98 | | dB |
| | CMRR Match (Channel-to-Channel) (Note 5) | $V_{CM} = -2\text{V}$ to 2V | 85 | 120 | | dB |
| PSRR | Power Supply Rejection Ratio | $V_S = \pm 1.25\text{V}$ to $\pm 5\text{V}$ | 60 | 74 | | dB |
| | | PSRR Match (Channel-to-Channel) (Note 5) | $V_S = \pm 1.25\text{V}$ to $\pm 5\text{V}$ | 70 | 100 | |
| V_{OL} | Output Voltage Swing LOW Saturation (Note 7) | No Load | | 5 | 50 | mV |
| | | $I_{SINK} = 5\text{mA}$ | | 87 | 190 | mV |
| | | $I_{SINK} = 20\text{mA}$ | | 245 | 460 | mV |
| V_{OH} | Output Voltage Swing HIGH Saturation (Note 7) | No Load | | 40 | 95 | mV |
| | | $I_{SOURCE} = 5\text{mA}$ | | 95 | 210 | mV |
| | | $I_{SOURCE} = 20\text{mA}$ | | 320 | 600 | mV |
| I_{SC} | Short-Circuit Current | | ± 30 | ± 40 | | mA |
| I_S | Supply Current per Amp | | | 2.8 | 3.5 | mA |
| GBW | Gain Bandwidth Product | Frequency = 1MHz | 70 | 100 | | MHz |
| SR | Slew Rate | $A_V = -1$, $R_L = 1\text{k}$, $V_O = 4\text{V}$ | 18 | 25 | | V/ μs |
| FPBW | Full Power Bandwidth (Note 9) | $V_{OUT} = 3V_{P-P}$ | 1.9 | 2.6 | | MHz |
| t_S | Settling Time | 0.1%, $V_{STEP} = 2\text{V}$, $A_V = -1$, $R_L = 1\text{k}$ | | 78 | | ns |
| dG | Differential Gain (Note 10) | $A_V = 2$, $R_F = R_G = 499\Omega$, $R_L = 2\text{k}$ | | 0.05 | | % |
| dP | Differential Phase (Note 10) | $A_V = 2$, $R_F = R_G = 499\Omega$, $R_L = 2\text{k}$ | | 0.03 | | DEG |

The ● denotes the specifications which apply over $0^\circ\text{C} < T_A < 70^\circ\text{C}$ temperature range. $V_S = \pm 5\text{V}$; $V_{CM} = V_{OUT} = 0\text{V}$, unless otherwise noted.

| SYMBOL | PARAMETER | CONDITIONS | | MIN | TYP | MAX | UNITS |
|--------------|--|---|---|------|------|-----|------------------------------|
| V_{OS} | Input Offset Voltage | LT6203, LT6204, LT6202S8 | ● | | 1.6 | 2.8 | mV |
| | | | ● | | 3.2 | 6.8 | mV |
| | | | ● | | 2.8 | 5.8 | mV |
| | | LT6202 SOT-23 | ● | | 1.6 | 3.0 | mV |
| | | | ● | | 3.2 | 7.3 | mV |
| | | | ● | | 2.8 | 6.3 | mV |
| $V_{OS\ TC}$ | Input Offset Voltage Drift (Note 8) | $V_{CM} = \text{Half Supply}$ | ● | | 7.5 | 24 | $\mu\text{V}/^\circ\text{C}$ |
| | Input Offset Voltage Match (Channel-to-Channel) (Note 5) | $V_{CM} = 0\text{V}$ | ● | | 0.2 | 1.0 | mV |
| | | $V_{CM} = V^-$ to V^+ | ● | | 0.5 | 2.2 | mV |
| I_B | Input Bias Current | $V_{CM} = \text{Half Supply}$ | ● | -7.0 | -1.4 | | μA |
| | | $V_{CM} = V^+$ | ● | | 1.8 | 3.6 | μA |
| | | $V_{CM} = V^-$ | ● | -10 | -4.3 | | μA |
| ΔI_B | I_B Shift | $V_{CM} = V^-$ to V^+ | ● | | 5.4 | 13 | μA |
| | I_B Match (Channel-to-Channel) (Note 5) | | ● | | 0.15 | 0.7 | μA |
| I_{OS} | Input Offset Current | $V_{CM} = \text{Half Supply}$ | ● | | 0.1 | 1 | μA |
| | | $V_{CM} = V^+$ | ● | | 0.2 | 1.2 | μA |
| | | $V_{CM} = V^-$ | ● | | 0.4 | 1.4 | μA |
| A_{VOL} | Large Signal Gain | $V_O = \pm 4.5\text{V}$, $R_L = 1\text{k}$ | ● | 70 | 120 | | V/mV |
| | | $V_O = \pm 2\text{V}$, $R_L = 100$ | ● | 10 | 18 | | V/mV |
| CMRR | Common Mode Rejection Ratio | $V_{CM} = V^-$ to V^+ | ● | 65 | 84 | | dB |
| | | $V_{CM} = -2\text{V}$ to 2V | ● | 83 | 95 | | dB |
| | CMRR Match (Channel-to-Channel) (Note 5) | $V_{CM} = -2\text{V}$ to 2V | ● | 83 | 110 | | dB |

LT6202/LT6203/LT6204

ELECTRICAL CHARACTERISTICS

The ● denotes the specifications which apply over 0°C < T_A < 70°C temperature range. V_S = ±5V; V_{CM} = V_{OUT} = 0V, unless otherwise noted.

| SYMBOL | PARAMETER | CONDITIONS | | MIN | TYP | MAX | UNITS |
|-----------------|---|---|---|-----|-----|-----|-------|
| PSRR | Power Supply Rejection Ratio | V _S = ±1.5V to ±5V | ● | 60 | 70 | | dB |
| | PSRR Match (Channel-to-Channel) (Note 5) | V _S = ±1.5V to ±5V | ● | 70 | 100 | | dB |
| V _{OL} | Output Voltage Swing LOW Saturation (Note 7) | No Load | ● | | 6 | 70 | mV |
| | | I _{SINK} = 5mA | ● | | 95 | 200 | mV |
| | | I _{SINK} = 15mA | ● | | 210 | 400 | mV |
| V _{OH} | Output Voltage Swing HIGH Saturation (Note 7) | No Load | ● | | 65 | 120 | mV |
| | | I _{SOURCE} = 5mA | ● | | 125 | 240 | mV |
| | | I _{SOURCE} = 20mA | ● | | 350 | 625 | mV |
| I _{SC} | Short-Circuit Current | | ● | ±25 | ±34 | | mA |
| I _S | Supply Current per Amp | | ● | | 3.5 | 4.3 | mA |
| GBW | Gain Bandwidth Product | Frequency = 1MHz | ● | | 95 | | MHz |
| SR | Slew Rate | A _V = -1, R _L = 1k, V _O = 4V | ● | 16 | 22 | | V/μs |
| FPBW | Full Power Bandwidth (Note 9) | V _{OUT} = 3V _{P-P} | ● | 1.7 | 2.3 | | MHz |

The ● denotes the specifications which apply over -40°C < T_A < 85°C temperature range. V_S = ±5V; V_{CM} = V_{OUT} = 0V, unless otherwise noted. (Note 4)

| SYMBOL | PARAMETER | CONDITIONS | | MIN | TYP | MAX | UNITS | |
|--------------------|--|--|---|------|------|-----|-------|--|
| V _{OS} | Input Offset Voltage | LT6203, LT6204, LT6202S8 | ● | | 1.7 | 3.0 | mV | |
| | | V _{CM} = 0V | ● | | 3.8 | 7.5 | mV | |
| | | V _{CM} = V ⁺ | ● | | 3.5 | 6.6 | mV | |
| | | V _{CM} = V ⁻ | ● | | | | | |
| | | LT6202 SOT-23 | ● | | 1.7 | 3.2 | mV | |
| | | V _{CM} = 0V | ● | | 3.8 | 7.7 | mV | |
| V _{OS TC} | Input Offset Voltage Drift (Note 8) | V _{CM} = V ⁺ | ● | | 3.5 | 6.7 | mV | |
| | | V _{CM} = V ⁻ | ● | | | | | |
| | | V _{CM} = V ⁻ | ● | | | | | |
| V _{OS TC} | Input Offset Voltage Drift (Note 8) | V _{CM} = Half Supply | ● | | 7.5 | 24 | μV/°C | |
| | | V _{CM} = V ⁻ to V ⁺ | ● | | 0.3 | 1.0 | mV | |
| I _B | Input Bias Current | V _{CM} = V ⁻ to V ⁺ | ● | | 0.6 | 2.5 | mV | |
| | | V _{CM} = V ⁻ | ● | | | | | |
| I _B | Input Bias Current | V _{CM} = Half Supply | ● | -7.0 | -1.4 | | μA | |
| | | V _{CM} = V ⁺ | ● | | 1.8 | 3.6 | μA | |
| | | V _{CM} = V ⁻ | ● | -10 | -4.5 | | μA | |
| ΔI _B | I _B Shift | V _{CM} = V ⁻ to V ⁺ | ● | | 5.4 | 13 | μA | |
| | | V _{CM} = V ⁻ to V ⁺ | ● | | 0.15 | 0.7 | μA | |
| I _{OS} | Input Offset Current | V _{CM} = Half Supply | ● | | 0.15 | 1 | μA | |
| | | V _{CM} = V ⁺ | ● | | 0.3 | 1.2 | μA | |
| | | V _{CM} = V ⁻ | ● | | 0.5 | 1.6 | μA | |
| A _{VOL} | Large Signal Gain | V _O = ±4.5V, R _L = 1k | ● | 60 | 110 | | V/mV | |
| | | V _O = ±1.5V, R _L = 100 | ● | 6.0 | 13 | | V/mV | |
| CMRR | Common Mode Rejection Ratio | V _{CM} = V ⁻ to V ⁺ | ● | 65 | 84 | | dB | |
| | | V _{CM} = -2V to 2V | ● | 80 | 95 | | dB | |
| | CMRR Match (Channel-to-Channel) (Note 5) | V _{CM} = -2V to 2V | ● | 80 | 110 | | dB | |
| PSRR | Power Supply Rejection Ratio | V _S = ±1.5V to ±5V | ● | 60 | 70 | | dB | |
| | | V _S = ±1.5V to ±5V | ● | 70 | 100 | | dB | |
| V _{OL} | Output Voltage Swing LOW Saturation (Note 7) | No Load | ● | | 7 | 75 | mV | |
| | | I _{SINK} = 5mA | ● | | 98 | 205 | mV | |
| | | I _{SINK} = 15mA | ● | | 260 | 500 | mV | |

ELECTRICAL CHARACTERISTICS The ● denotes the specifications which apply over $-40^{\circ}\text{C} < T_A < 85^{\circ}\text{C}$ temperature range. $V_S = \pm 5\text{V}$; $V_{CM} = V_{OUT} = 0\text{V}$, unless otherwise noted. (Note 4)

| SYMBOL | PARAMETER | CONDITIONS | | MIN | TYP | MAX | UNITS |
|----------|---|--|---|----------|----------|-----|------------------|
| V_{OH} | Output Voltage Swing HIGH Saturation (Note 7) | No Load | ● | | 70 | 130 | mV |
| | | $I_{SOURCE} = 5\text{mA}$ | ● | | 130 | 250 | mV |
| | | $I_{SOURCE} = 15\text{mA}$ | ● | | 360 | 640 | mV |
| I_{SC} | Short-Circuit Current | | ● | ± 15 | ± 25 | | mA |
| I_S | Supply Current per Amp | | ● | | 3.8 | 4.5 | mA |
| GBW | Gain Bandwidth Product | Frequency = 1MHz | ● | | 90 | | MHz |
| SR | Slew Rate | $A_V = -1$, $R_L = 1\text{k}$, $V_O = 4\text{V}$ | ● | 13 | 18 | | V/ μs |
| FPBW | Full Power Bandwidth (Note 9) | $V_{OUT} = 3V_{P-P}$ | ● | 1.4 | 1.9 | | MHz |

The ● denotes the specifications which apply over $-40^{\circ}\text{C} < T_A < 125^{\circ}\text{C}$ temperature range. $V_S = \pm 5\text{V}$; $V_{CM} = V_{OUT} = 0\text{V}$, unless otherwise noted. (Note 4)

| SYMBOL | PARAMETER | CONDITIONS | | MIN | TYP | MAX | UNITS |
|--------------|--|---|---|----------|----------|-----|--------------------------------|
| V_{OS} | Input Offset Voltage | LT6203 | ● | | 1.7 | 3.7 | mV |
| | | $V_{CM} = 0\text{V}$ | ● | | 3.8 | 9.1 | mV |
| | | $V_{CM} = V^+$ | ● | | 3.5 | 7.6 | mV |
| | | $V_{CM} = V^-$ | ● | | | | |
| | | LT6202 | ● | | 1.7 | 3.2 | mV |
| | | $V_{CM} = 0\text{V}$ | ● | | 3.8 | 9.0 | mV |
| $V_{OS\ TC}$ | Input Offset Voltage Drift (Note 8) | $V_{CM} = V^+$ | ● | | 3.5 | 7.5 | mV |
| | | $V_{CM} = V^-$ | ● | | | | |
| | | $V_{CM} = 0\text{V}$ | ● | | | | |
| $V_{OS\ TC}$ | Input Offset Voltage Match (Channel-to-Channel) (Note 5) | $V_{CM} = \text{Half Supply}$ | ● | | 7.5 | 24 | $\mu\text{V}/^{\circ}\text{C}$ |
| | | $V_{CM} = 0\text{V}$ | ● | | 0.3 | 1.2 | mV |
| I_B | Input Bias Current | $V_{CM} = V^- \text{ to } V^+$ | ● | | 0.6 | 3.0 | mV |
| | | $V_{CM} = V^-$ | ● | | | | |
| ΔI_B | I_B Shift | $V_{CM} = \text{Half Supply}$ | ● | -7.3 | -1.4 | | μA |
| | | $V_{CM} = V^+$ | ● | | 1.8 | 4.0 | μA |
| | | $V_{CM} = V^-$ | ● | -11.1 | -4.5 | | μA |
| ΔI_B | I_B Match (Channel-to-Channel) (Note 5) | $V_{CM} = V^- \text{ to } V^+$ | ● | | 5.4 | 15 | μA |
| | | $V_{CM} = V^-$ | ● | | 0.15 | 0.7 | μA |
| I_{OS} | Input Offset Current | $V_{CM} = \text{Half Supply}$ | ● | | 0.15 | 1.1 | μA |
| | | $V_{CM} = V^+$ | ● | | 0.3 | 1.3 | μA |
| | | $V_{CM} = V^-$ | ● | | 0.5 | 1.6 | μA |
| A_{VOL} | Large Signal Gain | $V_O = \pm 4.5\text{V}$, $R_L = 1\text{k}$ | ● | 54 | 110 | | V/mV |
| | | $V_O = \pm 1.5\text{V}$, $R_L = 100$ | ● | 5.7 | 13 | | V/mV |
| CMRR | Common Mode Rejection Ratio | $V_{CM} = V^- \text{ to } V^+$ | ● | 65 | 84 | | dB |
| | | $V_{CM} = -2\text{V to } 2\text{V}$ | ● | 79 | 95 | | dB |
| PSRR | Power Supply Rejection Ratio | $V_{CM} = -2\text{V to } 2\text{V}$ | ● | 80 | 110 | | dB |
| | | $V_S = \pm 1.5\text{V to } \pm 5\text{V}$ | ● | 60 | 70 | | dB |
| V_{OL} | Output Voltage Swing LOW Saturation (Note 7) | $V_S = \pm 1.5\text{V to } \pm 5\text{V}$ | ● | 70 | 100 | | dB |
| | | No Load | ● | | 7 | 75 | mV |
| V_{OL} | Output Voltage Swing LOW Saturation (Note 7) | $I_{SINK} = 5\text{mA}$ | ● | | 98 | 215 | mV |
| | | $I_{SINK} = 15\text{mA}$ | ● | | 260 | 500 | mV |
| | | No Load | ● | | 70 | 150 | mV |
| V_{OH} | Output Voltage Swing HIGH Saturation (Note 7) | $I_{SOURCE} = 5\text{mA}$ | ● | | 130 | 270 | mV |
| | | $I_{SOURCE} = 15\text{mA}$ | ● | | 360 | 640 | mV |
| | | No Load | ● | | | | |
| I_{SC} | Short-Circuit Current | | ● | ± 15 | ± 25 | | mA |

LT6202/LT6203/LT6204

ELECTRICAL CHARACTERISTICS

The ● denotes the specifications which apply over $-40^{\circ}\text{C} < T_A < 125^{\circ}\text{C}$ temperature range. $V_S = \pm 5\text{V}$; $V_{\text{CM}} = V_{\text{OUT}} = 0\text{V}$, unless otherwise noted. (Note 4)

| SYMBOL | PARAMETER | CONDITIONS | | MIN | TYP | MAX | UNITS |
|--------|-------------------------------|--|---|-----|-----|-----|------------------|
| I_S | Supply Current per Amp | | ● | | 3.8 | 5.3 | mA |
| GBW | Gain Bandwidth Product | Frequency = 1MHz | ● | | 90 | | MHz |
| SR | Slew Rate | $A_V = -1$, $R_L = 1\text{k}$, $V_O = 4\text{V}$ | ● | 13 | 18 | | V/ μs |
| FPBW | Full Power Bandwidth (Note 9) | $V_{\text{OUT}} = 3V_{\text{P-P}}$ | ● | 1.4 | 1.9 | | MHz |

Note 1: Stresses beyond those listed under Absolute Maximum Ratings may cause permanent damage to the device. Exposure to any Absolute Maximum Rating condition for extended periods may affect device reliability and lifetime.

Note 2: Inputs are protected by back-to-back diodes and diodes to each supply. If the inputs are taken beyond the supplies or the differential input voltage exceeds 0.7V, the input current must be limited to less than 40mA.

Note 3: A heat sink may be required to keep the junction temperature below the absolute maximum rating when the output is shorted indefinitely.

Note 4: The LT6202C/LT6203C/LT6204C are guaranteed to meet specified performance from 0°C to 70°C . The LT6202C/LT6203C/LT6204C are designed, characterized and expected to meet specified performance from -40°C to 85°C , but are not tested or QA sampled at these temperatures.

The LT6202I/LT6203I/LT6204I are guaranteed to meet specified performance from -40°C to 85°C . The LT6202H and LT6203H are guaranteed to meet specified performance from -40°C to 125°C .

Note 5: Matching parameters are the difference between the two amplifiers A and D and between B and C of the LT6204; between the two amplifiers of the LT6203. CMRR and PSRR match are defined as follows: CMRR and PSRR are measured in $\mu\text{V/V}$ on the identical amplifiers. The difference is calculated between the matching sides in $\mu\text{V/V}$. The result is converted to dB.

Note 6: Minimum supply voltage is guaranteed by power supply rejection ratio test.

Note 7: Output voltage swings are measured between the output and power supply rails.

Note 8: This parameter is not 100% tested.

Note 9: Full-power bandwidth is calculated from the slew rate:

$$\text{FPBW} = \text{SR} / 2\pi V_P$$

Note 10: Differential gain and phase are measured using a Tektronix TSG120YC/NTSC signal generator and a Tektronix 1780R Video Measurement Set. The resolution of this equipment is 0.1% and 0.1° . Ten identical amplifier stages were cascaded giving an effective resolution of 0.01% and 0.01° .

TYPICAL PERFORMANCE CHARACTERISTICS

V_{OS} Distribution, $V_{CM} = V^+/2$

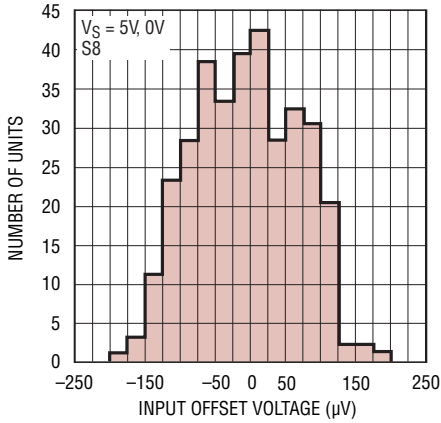

LT6202/03/04 G01

V_{OS} Distribution, $V_{CM} = V^+$



LT6202/03/04 G02

V_{OS} Distribution, $V_{CM} = V^-$



LT6202/03/04 G03

Supply Current vs Supply Voltage (Both Amplifiers)

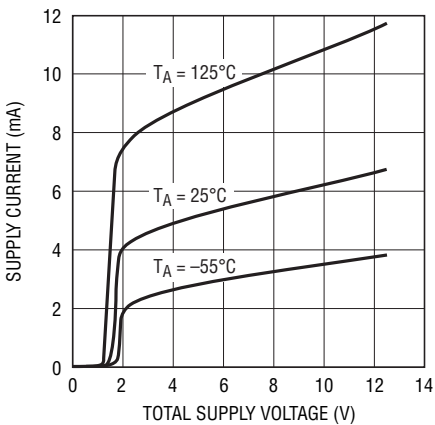

LT6202/03/04 G04

Offset Voltage vs Input Common Mode Voltage



LT6202/03/04 G05

Input Bias Current vs Common Mode Voltage

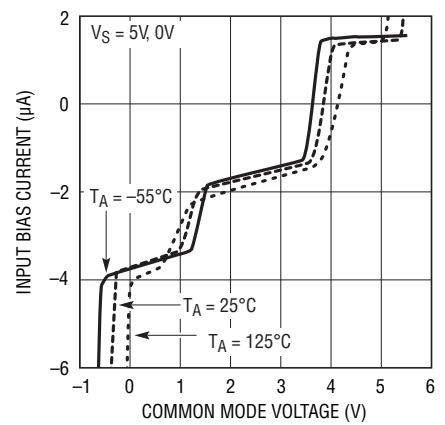

LT6202/03/04 G06

Input Bias Current vs Temperature

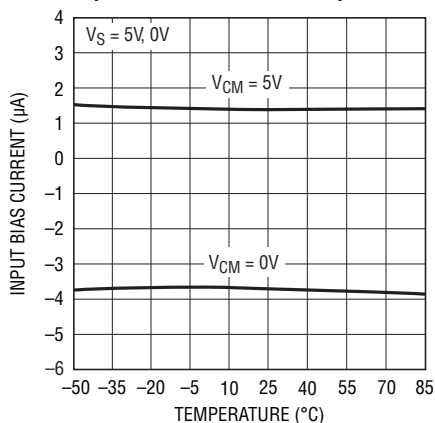

LT6202/03/04 G07

Output Saturation Voltage vs Load Current (Output Low)

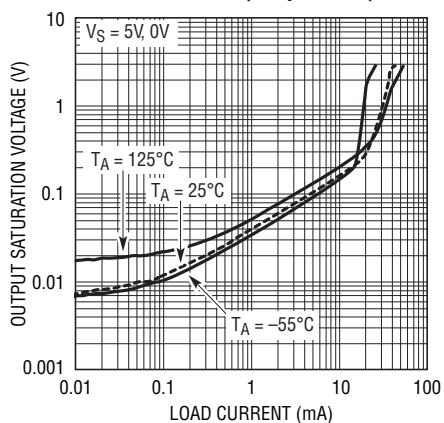

LT6202/03/04 G08

Output Saturation Voltage vs Load Current (Output High)



LT6202/03/04 G09

TYPICAL PERFORMANCE CHARACTERISTICS

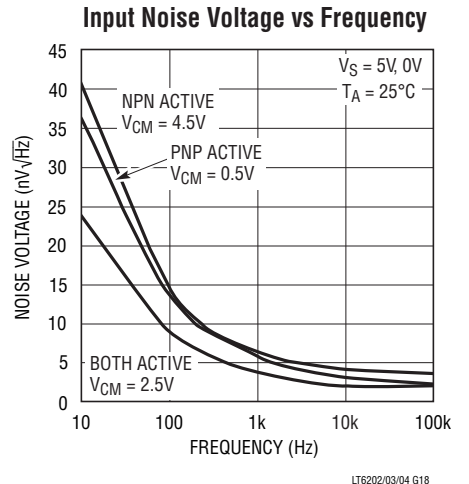
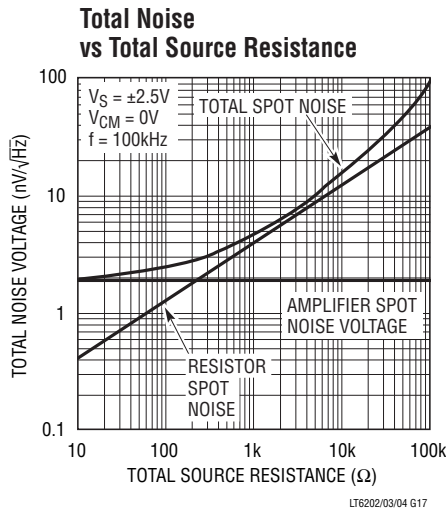
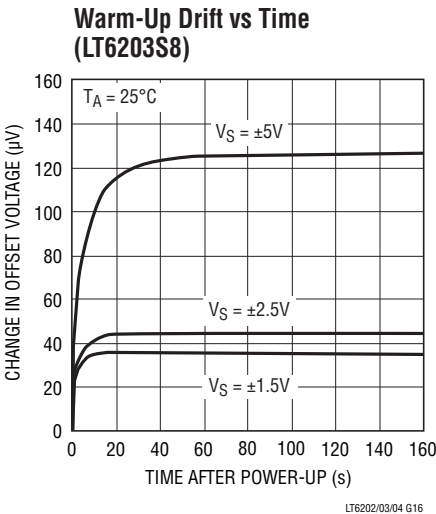
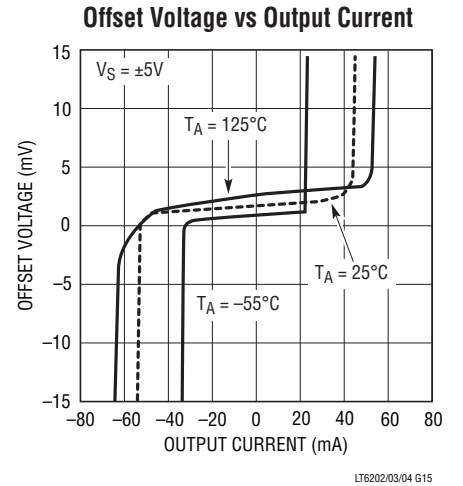
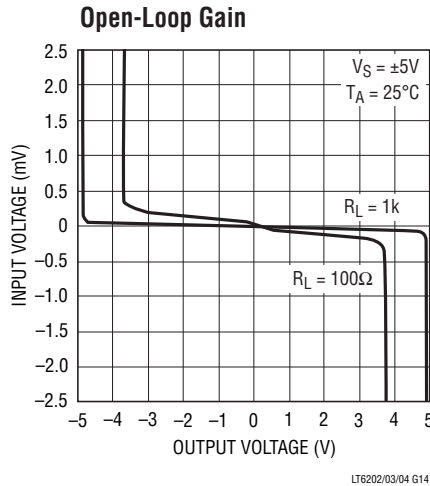
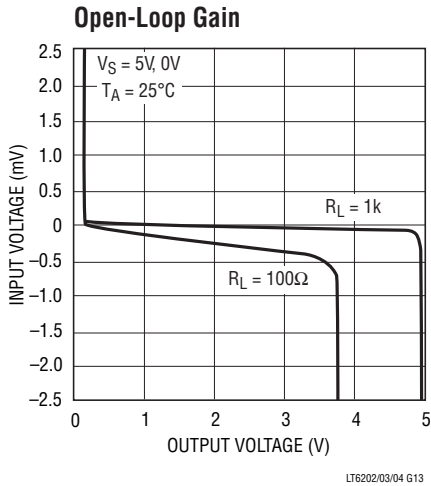
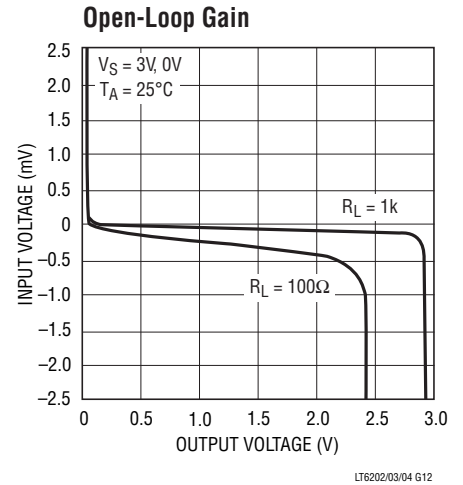
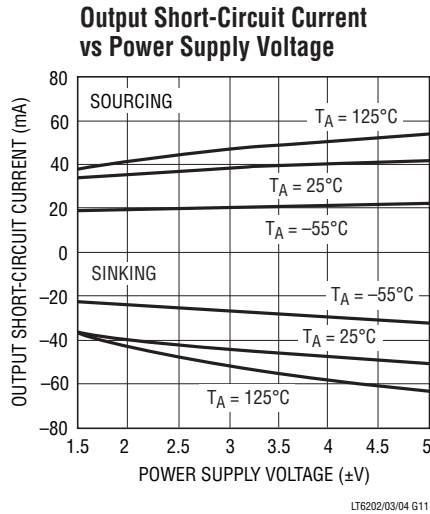
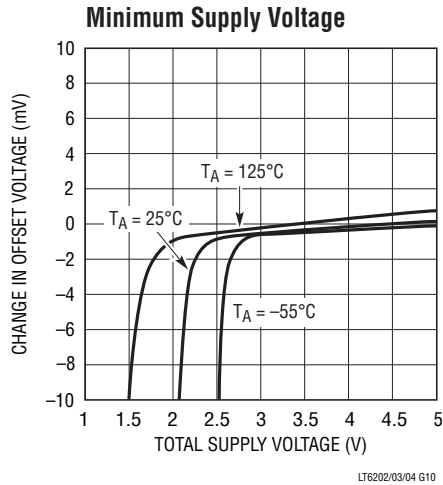

TYPICAL PERFORMANCE CHARACTERISTICS

Balanced Noise Current vs Frequency

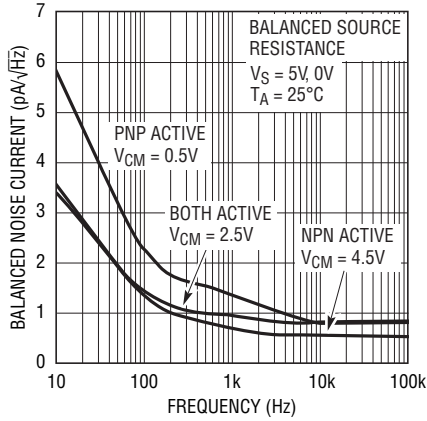

LT6202/03/04 G19

Unbalanced Noise Current vs Frequency

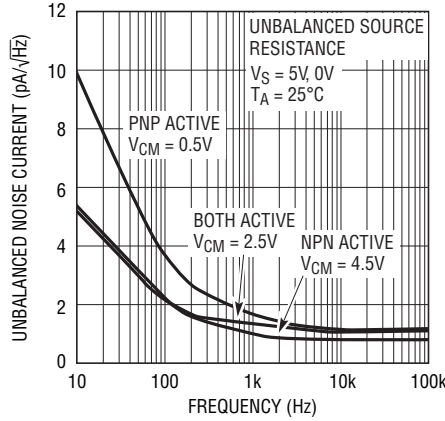

LT6202/03/04 G19.1

0.1Hz to 10Hz Output Voltage Noise

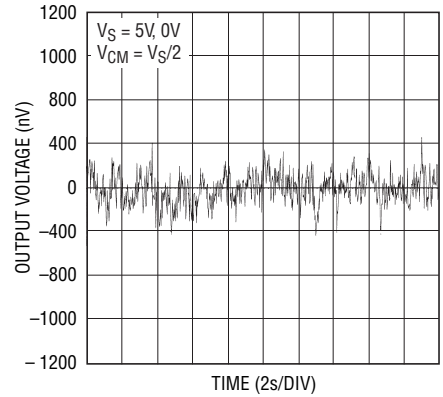

LT6202/03/04 G20

Gain Bandwidth and Phase Margin vs Temperature

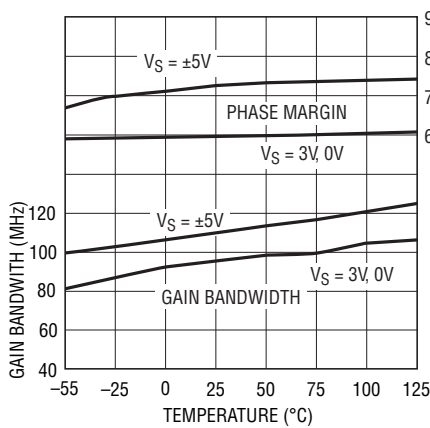

LT6202/03/04 G21

Open-Loop Gain vs Frequency

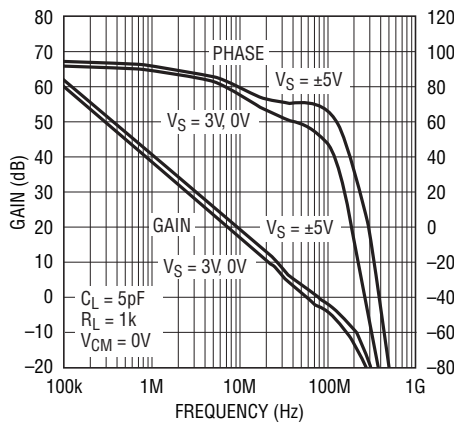

LT6202/03/04 G22

Open-Loop Gain vs Frequency

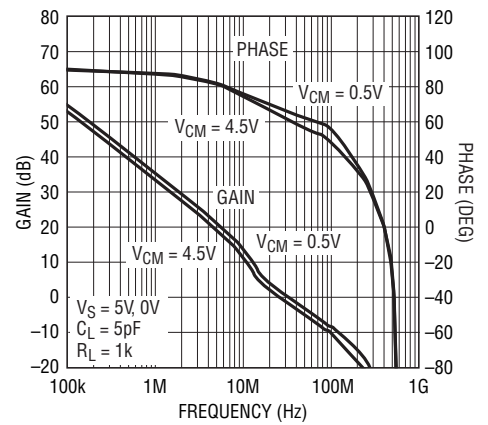

LT6202/03/04 G23

Gain Bandwidth and Phase Margin vs Supply Voltage

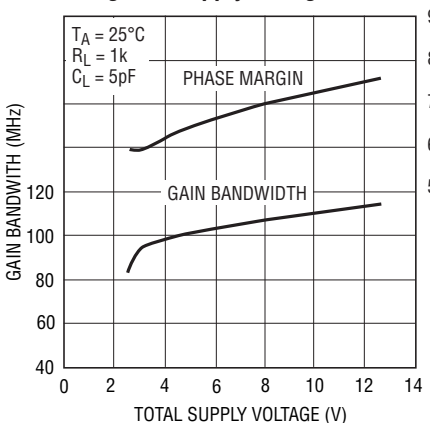

LT6202/03/04 G24

Slew Rate vs Temperature

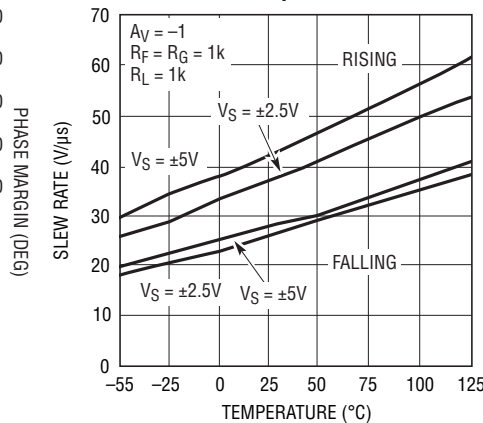

LT6202/03/04 G25

Output Impedance vs Frequency

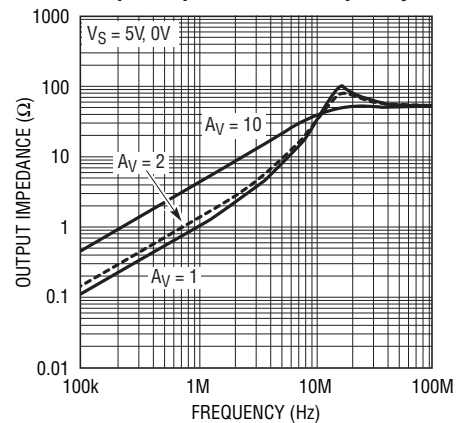

LT6202/03/04 G26

TYPICAL PERFORMANCE CHARACTERISTICS

Common Mode Rejection Ratio vs Frequency

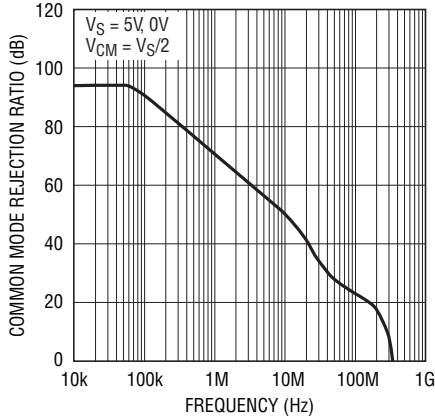

LT6202/03/04 G27

Channel Separation vs Frequency

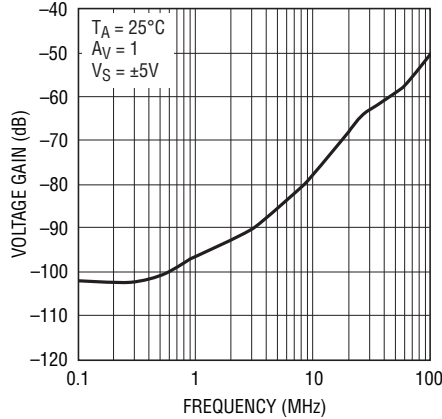

LT6202/03/04 G27.1

Power Supply Rejection Ratio vs Frequency

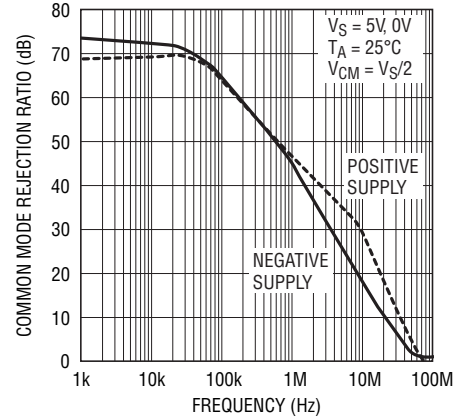

LT6202/03/04 G28

Series Output Resistor vs Capacitive Load

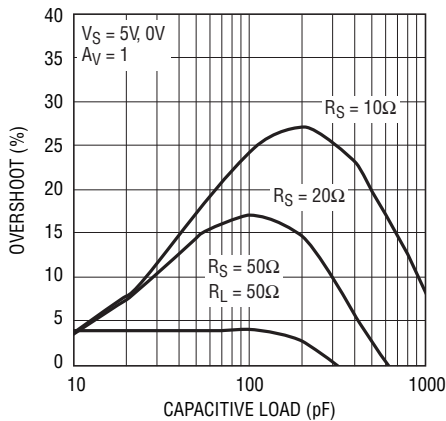

LT6202/03/04 G29

Series Output Resistor vs Capacitive Load

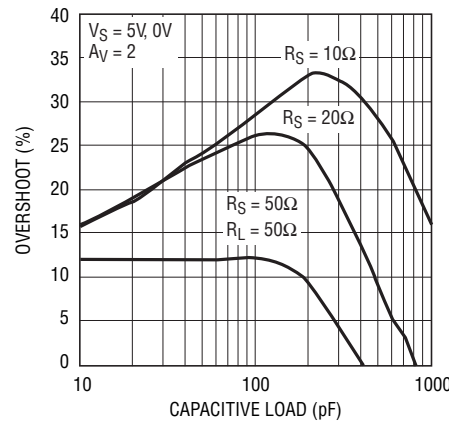

LT6202/03/04 G30

Settling Time vs Output Step (Noninverting)

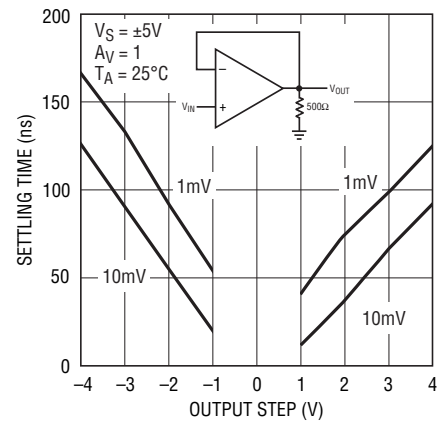

LT6202/03/04 G31

Settling Time vs Output Step (Inverting)

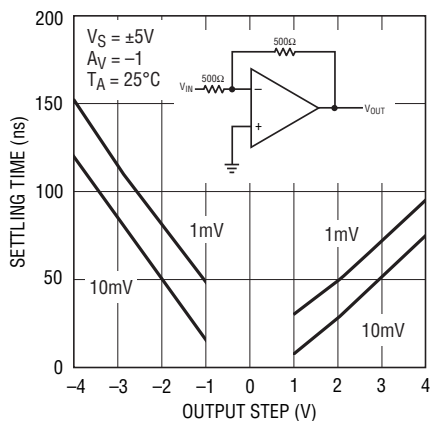

LT6202/03/04 G32

Maximum Undistorted Output Signal vs Frequency

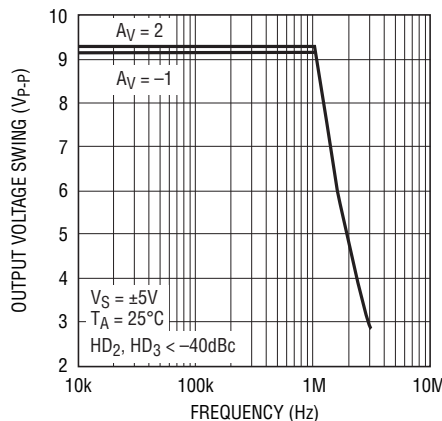

LT6202/03/04 G33

Distortion vs Frequency

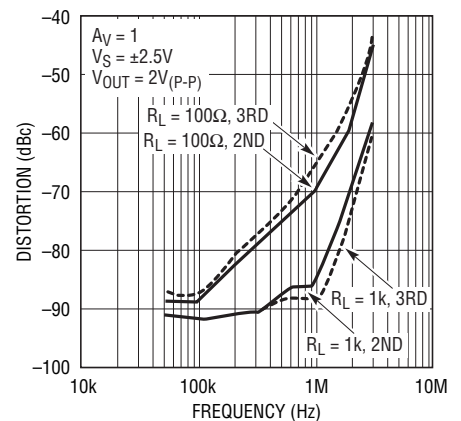

LT6202/03/04 G34

TYPICAL PERFORMANCE CHARACTERISTICS

Distortion vs Frequency

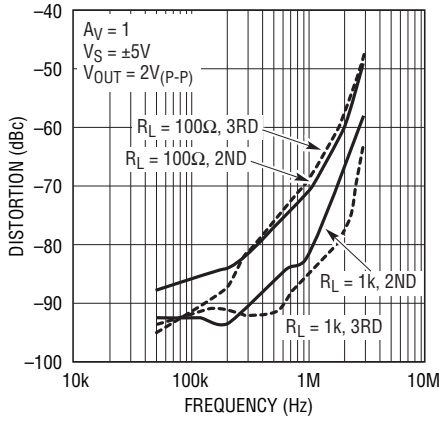

LT6202/03/04 G35

Distortion vs Frequency

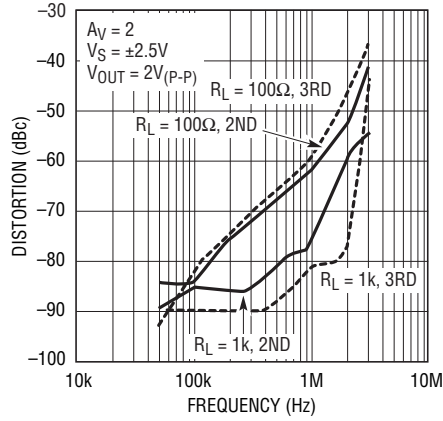

LT6202/03/04 G36

Distortion vs Frequency

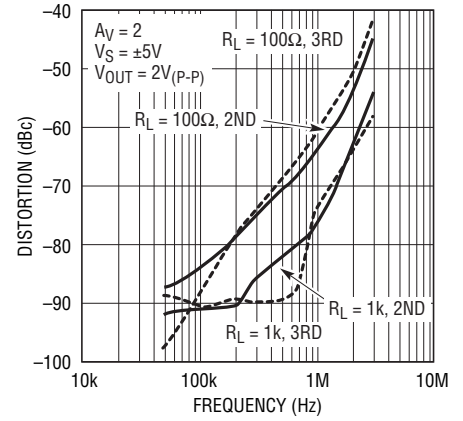

LT6202/03/04 G37

5V Large-Signal Response

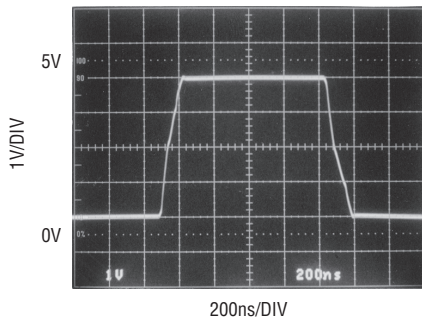

$V_S = 5V, 0V$
 $A_V = 1$
 $R_L = 1k$

LT6202/03/04 G38

5V Small-Signal Response

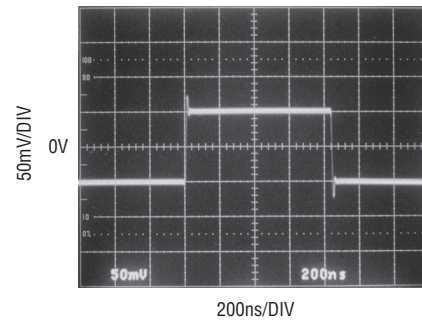

$V_S = 5V, 0V$
 $A_V = 1$
 $R_L = 1k$

LT6202/03/04 G39

±5V Large-Signal Response

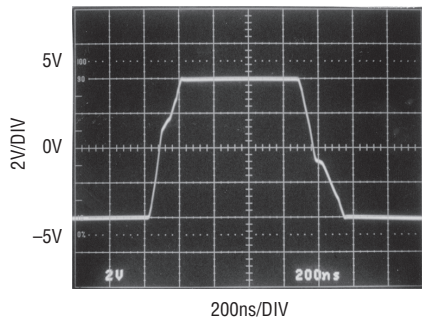

$V_S = \pm 5V$
 $A_V = 1$
 $R_L = 1k$

LT6202/03/04 G40

Output-Overdrive Recovery

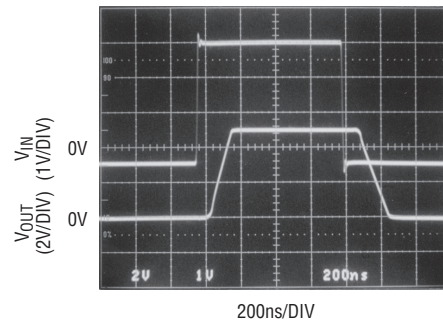

$V_S = 5V, 0V$
 $A_V = 2$

LT6202/03/04 G41

APPLICATIONS INFORMATION

Amplifier Characteristics

Figure 1 shows a simplified schematic of the LT6202/LT6203/LT6204, which has two input differential amplifiers in parallel that are biased on simultaneously when the common mode voltage is at least 1.5V from either rail. This topology allows the input stage to swing from the positive supply voltage to the negative supply voltage. As the common mode voltage swings beyond $V_{CC} - 1.5V$, current source I_1 saturates and current in Q1/Q4 is zero. Feedback is maintained through the Q2/Q3 differential amplifier, but with an input g_m reduction of 1/2. A similar effect occurs with I_2 when the common mode voltage swings within 1.5V of the negative rail. The effect of the g_m reduction is a shift in the V_{OS} as I_1 or I_2 saturate.

Input bias current normally flows out of the + and – inputs. The magnitude of this current increases when the input common mode voltage is within 1.5V of the negative rail, and only Q1/Q4 are active. The polarity of this current reverses when the input common mode voltage is within 1.5V of the positive rail and only Q2/Q3 are active.

The second stage is a folded cascode and current mirror that converts the input stage differential signals to a single ended output. Capacitor C1 reduces the unity cross frequency and improves the frequency stability without degrading the gain bandwidth of the amplifier. The differential drive generator supplies current to the output transistors that swing from rail-to-rail.

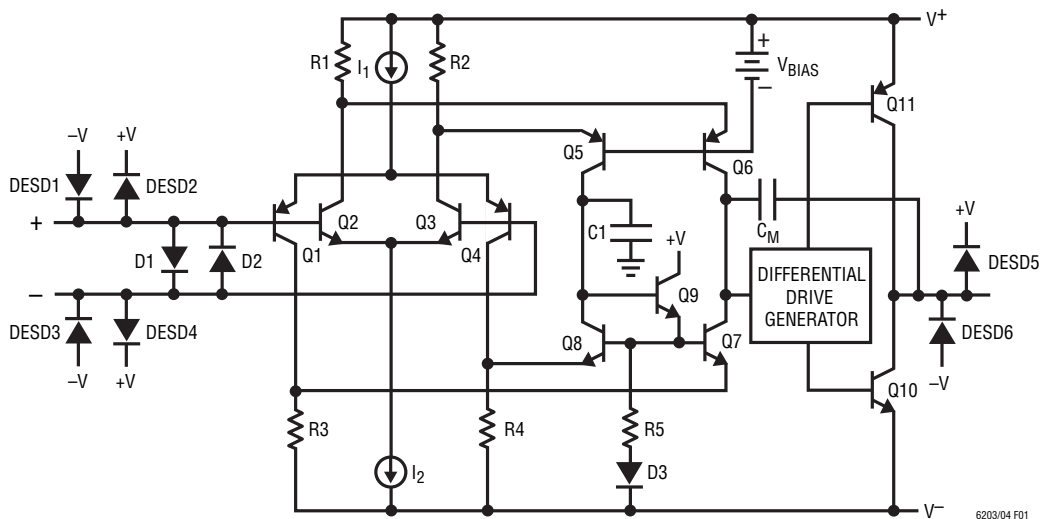

Figure 1. Simplified Schematic

APPLICATIONS INFORMATION

Input Protection

There are back-to-back diodes, D1 and D2, across the + and – inputs of these amplifiers to limit the differential input voltage to $\pm 0.7V$. The inputs of the LT6202/LT6203/LT6304 do not have internal resistors in series with the input transistors. This technique is often used to protect the input devices from over voltage that causes excessive currents to flow. The addition of these resistors would significantly degrade the low noise voltage of these amplifiers. For instance, a 100Ω resistor in series with each input would generate $1.8nV/\sqrt{Hz}$ of noise, and the total amplifier noise voltage would rise from $1.9nV/\sqrt{Hz}$ to $2.6nV/\sqrt{Hz}$. Once the input differential voltage exceeds $\pm 0.7V$, steady state current conducted through the protection diodes should be limited to $\pm 40mA$. This implies 25Ω of protection resistance per volt of continuous overdrive beyond $\pm 0.7V$. The input diodes are rugged enough to handle transient currents due to amplifier slew rate overdrive or momentary clipping without these resistors.

Figure 2 shows the input and output waveforms of the amplifier driven into clipping while connected in a gain of $A_V = 1$. When the input signal goes sufficiently beyond the power supply rails, the input transistors will saturate. When saturation occurs, the amplifier loses a stage of phase inversion and the output tries to change states. Diodes D1 and D2 forward bias and hold the output within



Figure 2. $V_S = \pm 2.5V$, $A_V = 1$ with Large Overdrive

a diode drop of the input signal. In this photo, the input signal generator is clipping at $\pm 35mA$, and the output transistors supply this generator current through the protection diodes.

With the amplifier connected in a gain of $A_V \geq 2$, the output can invert with very heavy input overdrive. To avoid this inversion, limit the input overdrive to $0.5V$ beyond the power supply rails.

ESD

The LT6202/LT6203/LT6204 have reverse-biased ESD protection diodes on all inputs and outputs as shown in Figure 1. If these pins are forced beyond either supply, unlimited current will flow through these diodes. If the current is transient and limited to one hundred milliamps or less, no damage to the device will occur.

Noise

The noise voltage of the LT6202/LT6203/LT6204 is equivalent to that of a 225Ω resistor, and for the lowest possible noise it is desirable to keep the source and feedback resistance at or below this value, i.e. $R_S + R_G \parallel R_{FB} \leq 225\Omega$. With $R_S + R_G \parallel R_{FB} = 225\Omega$ the total noise of the amplifier is: $e_n = \sqrt{(1.9nV)^2 + (1.9nV)^2} = 2.7nV$. Below this resistance value, the amplifier dominates the noise, but in the resistance region between 225Ω and approximately $10k\Omega$, the noise is dominated by the resistor thermal noise. As the total resistance is further increased, beyond $10k$, the noise current multiplied by the total resistance eventually dominates the noise.

The product of $e_n \cdot \sqrt{I_{SUPPLY}}$ is an interesting way to gauge low noise amplifiers. Many low noise amplifiers with low e_n have high I_{SUPPLY} current. In applications that require low noise with the lowest possible supply current, this product can prove to be enlightening. The LT6202/LT6203/LT6204 have an $e_n \cdot \sqrt{I_{SUPPLY}}$ product of 3.2 per amplifier, yet it is common to see amplifiers with similar noise specifications have an $e_n \cdot \sqrt{I_{SUPPLY}}$ product of 4.7 to 13.5.

For a complete discussion of amplifier noise, see the LT1028 data sheet.

TYPICAL APPLICATIONS

Low Noise, Low Power 1MΩ AC Photodiode Transimpedance Amplifier

Figure 3 shows the LT6202 applied as a transimpedance amplifier (TIA). The LT6202 forces the BF862 ultralow-noise JFET source to 0V, with R3 ensuring that the JFET has an I_{DRAIN} of 1mA. The JFET acts as a source follower, buffering the input of the LT6202 and making it suitable for the high impedance feedback elements R1 and R2. The BF862 has a minimum I_{DSS} of 10mA and a pinchoff voltage between $-0.3V$ and $-1.2V$. The JFET gate and the LT6202 output

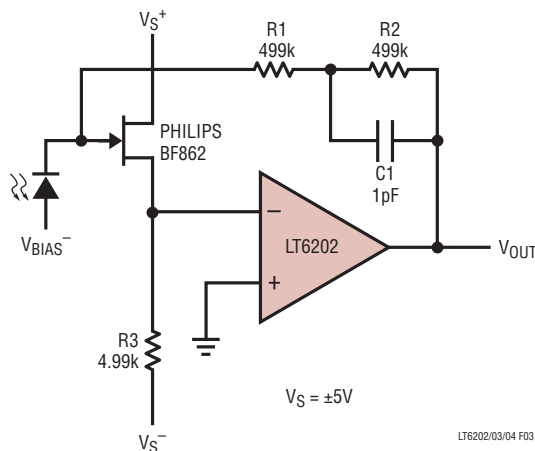

Figure 3. Low Noise, Low Power 1MΩ AC Photodiode Transimpedance Amplifier

therefore sit at a point slightly higher than one pinchoff voltage below ground (typically about $-0.6V$). When the photodiode is illuminated, the current must come from the LT6202's output through R1 and R2, as in a normal TIA. Amplifier input noise density and gain-bandwidth product were measured at $2.4nV/Hz$ and $100MHz$, respectively. Note that because the JFET has a high g_m , approximately $1/80\Omega$, its attenuation looking into R3 is only about 2%. Gain-bandwidth product was measured at $100MHz$ and the closed-loop bandwidth using a $3pF$ photodiode was approximately $1.4MHz$.

Precision Low Noise, Low Power, 1MΩ Photodiode Transimpedance Amplifier

Figure 4 shows the LT6202 applied as a transimpedance amplifier (TIA), very similar to that shown in Figure 3. In this case, however, the JFET is not allowed to dictate the DC-bias conditions. Rather than being grounded, the LT6202's noninverting input is driven by the LTC2050 to the exact state necessary for zero JFET gate voltage. The noise performance is nearly identical to that of the circuit in Figure 3, with the additional benefit of excellent DC performance. Input offset was measured at under $200\mu V$ and output noise was within $2mV_{P-P}$ over a $20MHz$ bandwidth.

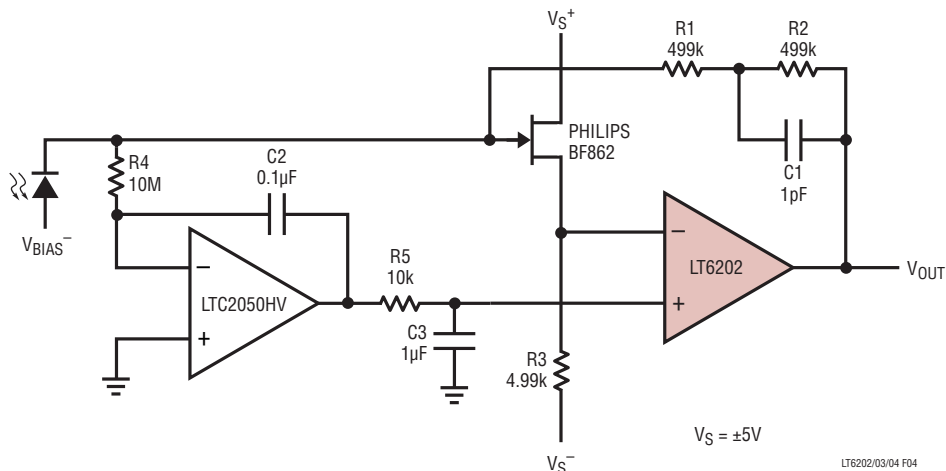

Figure 4. Precision Low Noise, Low Power Transimpedance Amplifier

TYPICAL APPLICATIONS

Single-Supply 16-Bit ADC Driver

Figure 5 shows the LT6203 driving an LTC1864 unipolar 16-bit A/D converter. The bottom half of the LT6203 is in a gain-of-one configuration and buffers the 0V negative full-scale signal V_{LOW} into the negative input of the LTC1864. The top half of the LT6203 is in a gain-of-ten configuration referenced to the buffered voltage V_{LOW} and drives the positive input of the LTC1864. The input range of the LTC1864 is 0V to 5V, but for best results the input range of V_{IN} should be from V_{LOW} (about 0.4V) to about 0.82V. Figure 6 shows an FFT obtained with a 10.1318kHz coherent input waveform, from 8192 samples with no windowing or averaging. Spurious free dynamic range is seen to be about 100dB.

Although the LTC1864 has a sample rate far below the gain bandwidth of the LT6203, using this amplifier is not necessarily a case of overkill. The designer is reminded that A/D converters have sample apertures that are vanishingly small (ideally, infinitesimally small) and make demands on the upstream circuitry far in excess of what is implied by the innocent-looking sample rate. In addition, when an A/D converter takes a sample, it applies a small capacitor to its inputs with a fair amount of glitch energy and expects the voltage on the capacitor to settle to the true value very quickly. Finally, the LTC1864 has a 20MHz analog input bandwidth and can be used in undersampling applications, again requiring a source bandwidth higher than Nyquist.

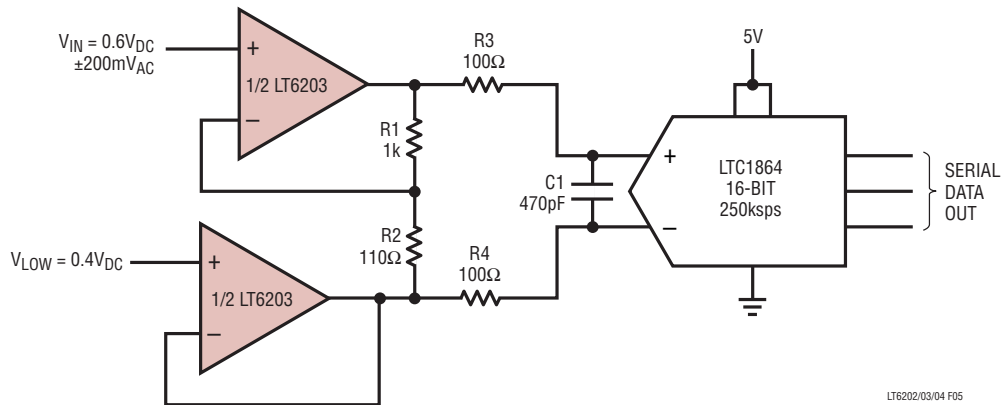

Figure 5. Single-Supply 16-Bit ADC Driver

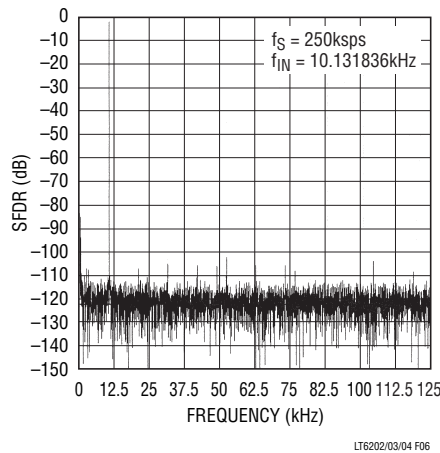
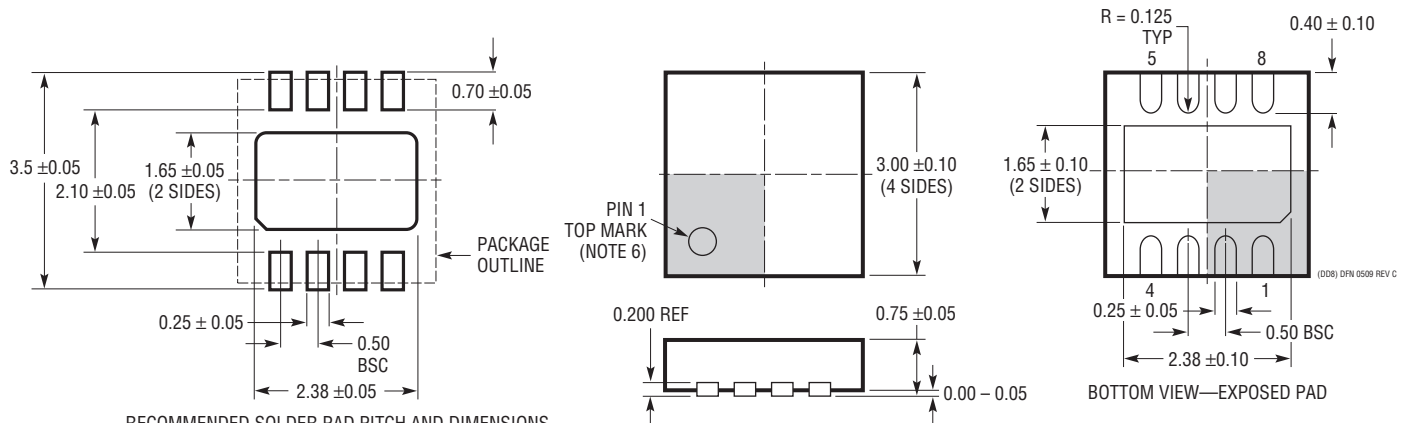

Figure 6. FFT Showing 100dB SFDR

PACKAGE DESCRIPTION

Please refer to <http://www.linear.com/designtools/packaging/> for the most recent package drawings.

DD Package 8-Lead Plastic DFN (3mm × 3mm) (Reference LTC DWG # 05-08-1698 Rev C)



RECOMMENDED SOLDER PAD PITCH AND DIMENSIONS
APPLY SOLDER MASK TO AREAS THAT ARE NOT SOLDERED

NOTE:

1. DRAWING TO BE MADE A JEDEC PACKAGE OUTLINE M0-229 VARIATION OF (WEED-1)
2. DRAWING NOT TO SCALE
3. ALL DIMENSIONS ARE IN MILLIMETERS
4. DIMENSIONS OF EXPOSED PAD ON BOTTOM OF PACKAGE DO NOT INCLUDE MOLD FLASH. MOLD FLASH, IF PRESENT, SHALL NOT EXCEED 0.15mm ON ANY SIDE
5. EXPOSED PAD SHALL BE SOLDER PLATED
6. SHADED AREA IS ONLY A REFERENCE FOR PIN 1 LOCATION ON TOP AND BOTTOM OF PACKAGE

GN Package 16-Lead Plastic SSOP (Narrow .150 Inch) (Reference LTC DWG # 05-08-1641)

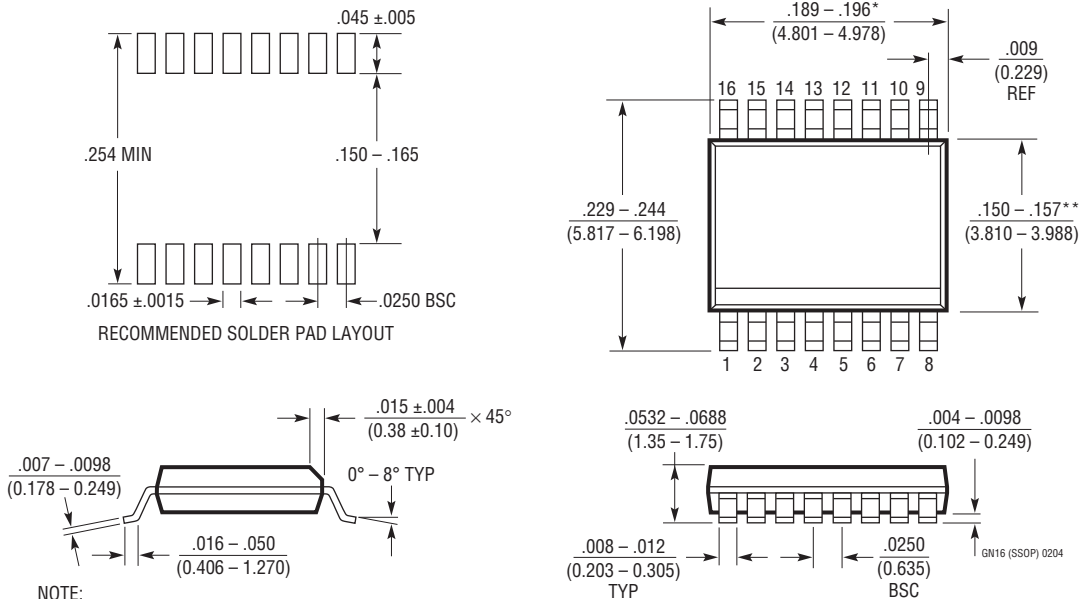

NOTE:

1. CONTROLLING DIMENSION: INCHES
 2. DIMENSIONS ARE IN $\frac{\text{INCHES}}{\text{MILLIMETERS}}$
 3. DRAWING NOT TO SCALE
- * DIMENSION DOES NOT INCLUDE MOLD FLASH. MOLD FLASH SHALL NOT EXCEED 0.006" (0.152mm) PER SIDE
- ** DIMENSION DOES NOT INCLUDE INTERLEAD FLASH. INTERLEAD FLASH SHALL NOT EXCEED 0.010" (0.254mm) PER SIDE

PACKAGE DESCRIPTION

Please refer to <http://www.linear.com/designtools/packaging/> for the most recent package drawings.

MS8 Package 8-Lead Plastic MSOP

(Reference LTC DWG # 05-08-1660 Rev F)

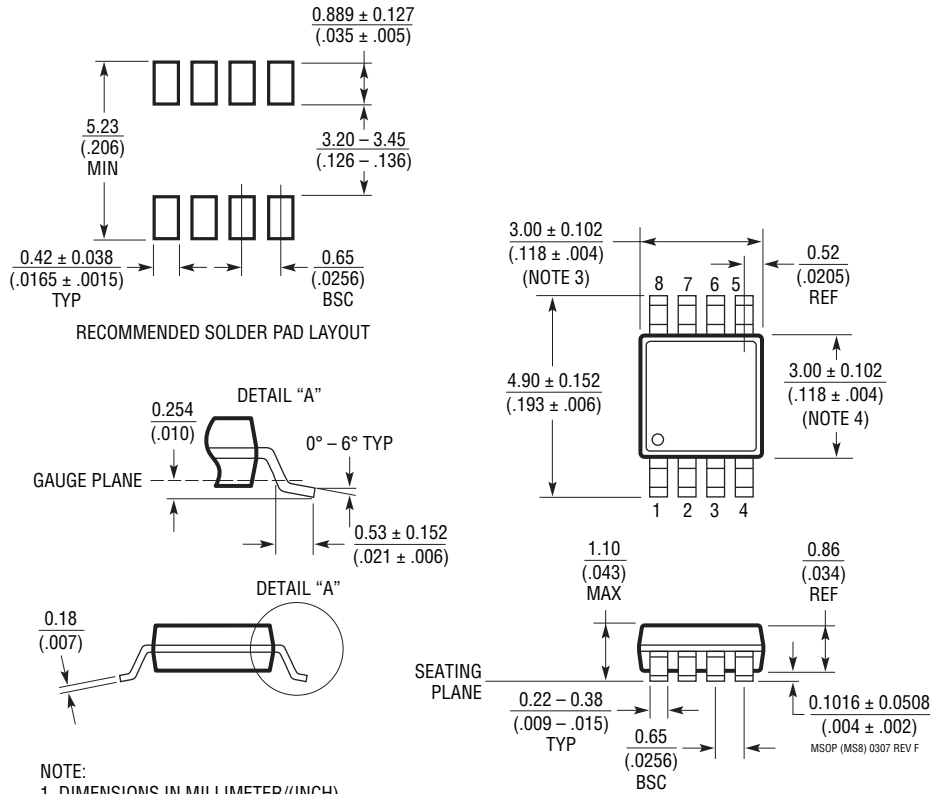

NOTE:

1. DIMENSIONS IN MILLIMETER/(INCH)
2. DRAWING NOT TO SCALE
3. DIMENSION DOES NOT INCLUDE MOLD FLASH, PROTRUSIONS OR GATE BURRS.
MOLD FLASH, PROTRUSIONS OR GATE BURRS SHALL NOT EXCEED 0.152mm (.006") PER SIDE
4. DIMENSION DOES NOT INCLUDE INTERLEAD FLASH OR PROTRUSIONS.
INTERLEAD FLASH OR PROTRUSIONS SHALL NOT EXCEED 0.152mm (.006") PER SIDE
5. LEAD COPLANARITY (BOTTOM OF LEADS AFTER FORMING) SHALL BE 0.102mm (.004") MAX

PACKAGE DESCRIPTION

Please refer to <http://www.linear.com/designtools/packaging/> for the most recent package drawings.

S8 Package 8-Lead Plastic Small Outline (Narrow .150 Inch) (Reference LTC DWG # 05-08-1610)

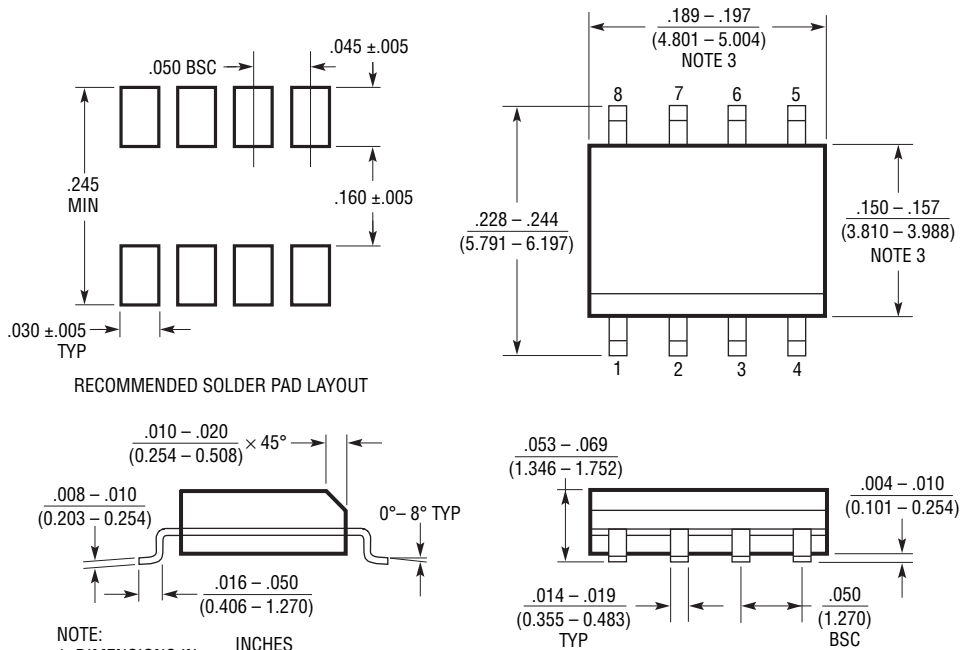

- NOTE:
1. DIMENSIONS IN $\frac{\text{INCHES}}{\text{MILLIMETERS}}$
 2. DRAWING NOT TO SCALE
 3. THESE DIMENSIONS DO NOT INCLUDE MOLD FLASH OR PROTRUSIONS. MOLD FLASH OR PROTRUSIONS SHALL NOT EXCEED $.006''$ (0.15mm)

S08 0303

PACKAGE DESCRIPTION

Please refer to <http://www.linear.com/designtools/packaging/> for the most recent package drawings.

S Package 14-Lead Plastic Small Outline (Narrow .150 Inch) (Reference LTC DWG # 05-08-1610)

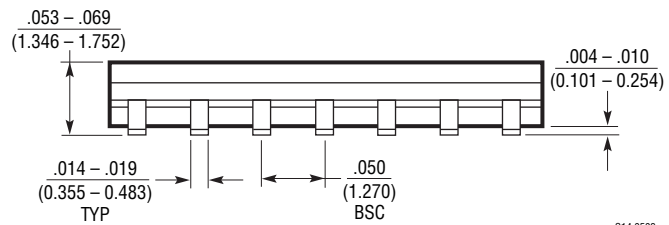
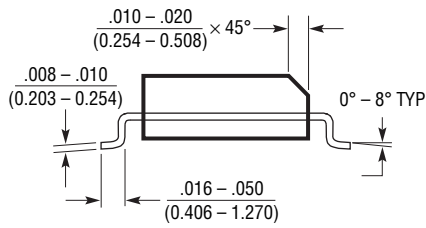

- NOTE:
1. DIMENSIONS IN $\frac{\text{INCHES}}{\text{MILLIMETERS}}$
 2. DRAWING NOT TO SCALE
 3. THESE DIMENSIONS DO NOT INCLUDE MOLD FLASH OR PROTRUSIONS. MOLD FLASH OR PROTRUSIONS SHALL NOT EXCEED .006" (0.15mm)

S14 0502

PACKAGE DESCRIPTION

Please refer to <http://www.linear.com/designtools/packaging/> for the most recent package drawings.

S5 Package 5-Lead Plastic TSOT-23 (Reference LTC DWG # 05-08-1635)

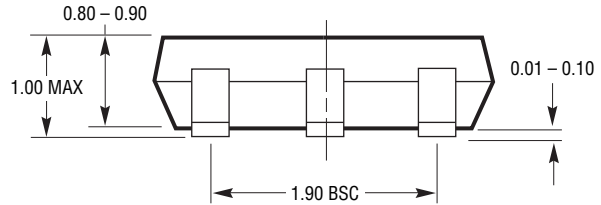
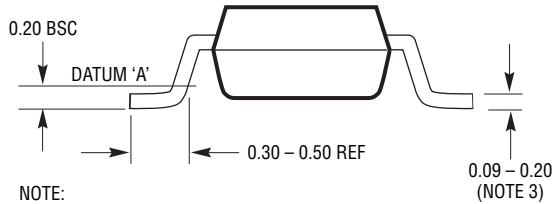
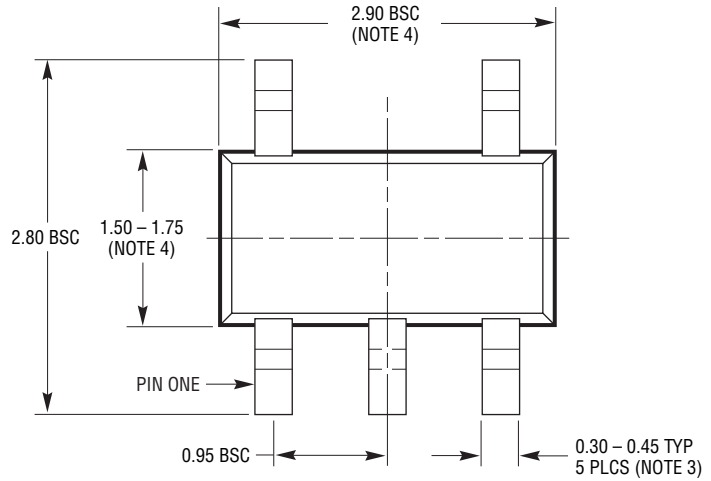
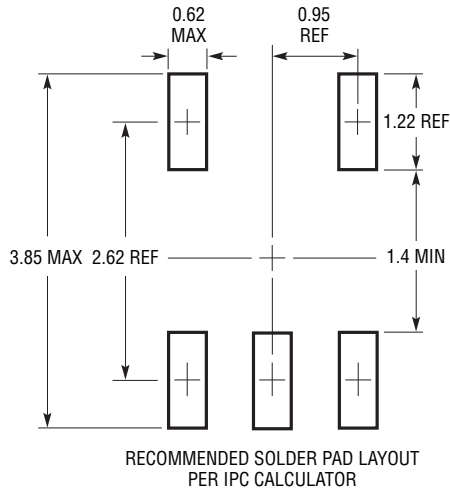

- NOTE:
1. DIMENSIONS ARE IN MILLIMETERS
 2. DRAWING NOT TO SCALE
 3. DIMENSIONS ARE INCLUSIVE OF PLATING
 4. DIMENSIONS ARE EXCLUSIVE OF MOLD FLASH AND METAL BURR
 5. MOLD FLASH SHALL NOT EXCEED 0.254mm
 6. JEDEC PACKAGE REFERENCE IS MO-193

SS TSOT-23 0302 REV B

REVISION HISTORY (Revision history begins at Rev C)

| REV | DATE | DESCRIPTION | PAGE NUMBER |
|-----|-------|---|-------------|
| C | 5/11 | Revised units to MΩ for Input Resistance Common Mode | 3 |
| D | 12/11 | Corrected LT part number in the Description section | 1 |
| | | Added H-grade | 1-12 |
| | | Removed DD package junction temperature and storage temperature range in Absolute Maximum Ratings and revised T _{JMAX} value for S5 and DD packages and θ _{JA} for DD package | 2 |
| | | Revised V _{OS} conditions in the Electrical Characteristics table | 7, 11 |

TYPICAL APPLICATION

Low Noise Differential Amplifier with Gain Adjust and Common Mode Control

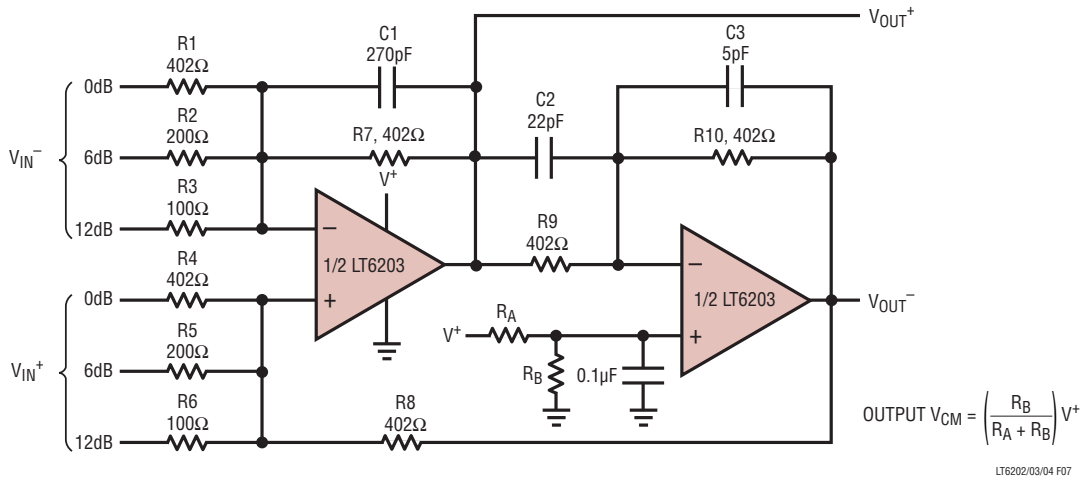

Low Noise Differential Amplifier Frequency Response

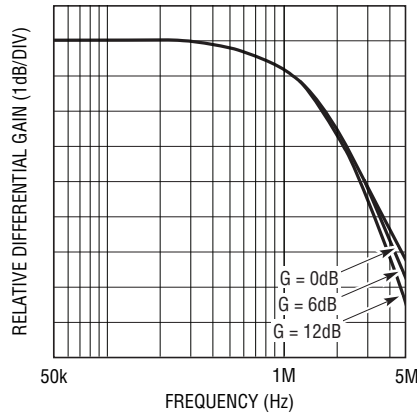

RELATED PARTS

| PART NUMBER | DESCRIPTION | COMMENTS |
|----------------------|---|--|
| LT1028 | Single, Ultralow Noise 50MHz Op Amp | 1.1nV/√Hz |
| LT1677 | Single, Low Noise Rail-to-Rail Amplifier | 3V Operation, 2.5mA, 4.5nV/√Hz, 60μV Max V _{OS} |
| LT1722/LT1723/LT1724 | Single/Dual/Quad Low Noise Precision Op Amps | 70V/μs Slew Rate, 400μV Max V _{OS} , 3.8nV/√Hz, 3.7mA |
| LT1800/LT1801/LT1802 | Single/Dual/Quad Low Power 80MHz Rail-to-Rail Op Amps | 8.5nV/√Hz, 2mA Max Supply |
| LT1806/LT1807 | Single/Dual, Low Noise 325MHz Rail-to-Rail Amplifiers | 2.5V Operation, 550μV Max V _{OS} , 3.5nV/√Hz |
| LT6200 | Single Ultralow Noise Rail-to-Rail Amplifier | 0.95nV/√Hz, 165MHz Gain Bandwidth |

Компания «Life Electronics» занимается поставками электронных компонентов импортного и отечественного производства от производителей и со складов крупных дистрибьюторов Европы, Америки и Азии.

С конца 2013 года компания активно расширяет линейку поставок компонентов по направлению коаксиальный кабель, кварцевые генераторы и конденсаторы (керамические, пленочные, электролитические), за счёт заключения дистрибьюторских договоров

Мы предлагаем:

- Конкурентоспособные цены и скидки постоянным клиентам.
- Специальные условия для постоянных клиентов.
- Подбор аналогов.
- Поставку компонентов в любых объемах, удовлетворяющих вашим потребностям.
- Приемлемые сроки поставки, возможна ускоренная поставка.
- Доставку товара в любую точку России и стран СНГ.
- Комплексную поставку.
- Работу по проектам и поставку образцов.
- Формирование склада под заказчика.
- Сертификаты соответствия на поставляемую продукцию (по желанию клиента).
- Тестирование поставляемой продукции.
- Поставку компонентов, требующих военную и космическую приемку.
- Входной контроль качества.
- Наличие сертификата ISO.

В составе нашей компании организован Конструкторский отдел, призванный помогать разработчикам, и инженерам.

Конструкторский отдел помогает осуществить:

- Регистрацию проекта у производителя компонентов.
- Техническую поддержку проекта.
- Защиту от снятия компонента с производства.
- Оценку стоимости проекта по компонентам.
- Изготовление тестовой платы монтаж и пусконаладочные работы.



Тел: +7 (812) 336 43 04 (многоканальный)
Email: org@lifeelectronics.ru