

Measurement condition

Ambient temperature T_A :	23	°C
Input power level:	0	dBm
Terminating impedance:		
Input:	190 Ω	-3.4 pF
Output:	190 Ω	-3.4 pF

Characteristics

Remark:

The reference level for the relative attenuation a_{rel} of the TFS 433AH is the minimum of the pass band attenuation a_{min} . The minimum of the pass band attenuation a_{min} is defined as the insertion loss a_e . The centre frequency f_C is the arithmetic mean value of the upper and lower frequencies at the 3 dB filter attenuation level relative to the insertion loss a_e . The nominal frequency f_N is fixed at 433.92 MHz without any tolerance. The given values for the relative attenuation a_{rel} have to be achieved at the frequencies given below even if the centre frequency f_C is shifted due to the temperature coefficient of frequency TC_f in the operating temperature range and due to a production tolerance for the centre frequency f_C .

D a t a	typ. value		tolerance / limit		
Insertion loss (reference level)	a_e	2.6 dB		max.	3.5 dB
Nominal frequency	f_N	-			433.92 MHz
Centre frequency	f_C	433.92 MHz			-
Bandwidth	BW				
2 dB		700 kHz		min.	400 kHz
3 dB		800 kHz		min.	440 kHz
6 dB		955 kHz		min.	560 kHz
Relative attenuation	a_{rel}				
f_N ... $f_N \pm 200.00$ kHz		- dB		max.	2.0 dB
$f_N \pm 200.00$ kHz ... $f_N \pm 220.00$ kHz		- dB		max.	3.0 dB
$f_N \pm 220.00$ kHz ... $f_N \pm 280.00$ kHz		- dB		max.	6.0 dB
$f_N - 1.0$ MHz ... $f_N - 5.92$ MHz		17 dB		min.	15 dB
$f_N - 5.92$ MHz ... $f_N - 19.92$ MHz		42 dB		min.	40 dB
$f_N - 19.92$ MHz ... $f_N - 423.92$ MHz		55 dB		min.	45 dB
$f_N + 1.00$ MHz ... $f_N + 8.00$ MHz		14 dB		min.	10 dB
$f_N + 116.08$ MHz ... $f_N + 566.00$ MHz		60 dB		min.	45 dB
Input power level		-		max.	0 dBm
Operating temperature range	OTR	-			-25 ... +80 °C
Storage temperature range		-			-55 ... +125 °C
Frequency inversion temperature		10 °C			-
Temperature coefficient of frequency	TC_f *)	-0.04 ppm/K ²			-

*) $\Delta f = TC_f(T - T_0)^2 f_N$

Generated:

Checked / Approved:

Vectron International GmbH
Potsdamer Straße 18
D 14 513 TELTOW / Germany
Tel: (+49) 3328 4784-0 / Fax: (+49) 3328 4784-30
E-Mail: tft@vectron.com

Vectron International GmbH reserves the right to make changes to the product(s) and/or information contained herein without notice. No liability is assumed as a result of their use or application. No rights under any patent accompany the sale of any such product(s) or information.

Filter characteristic

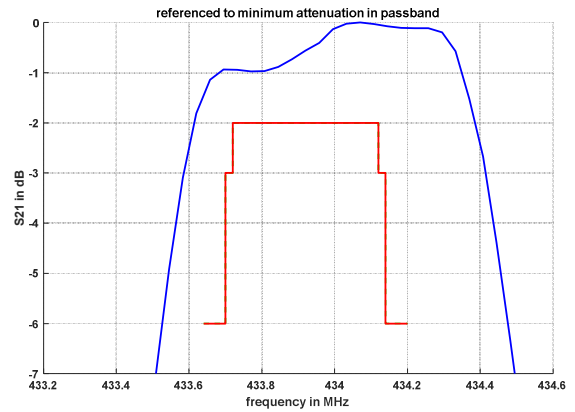
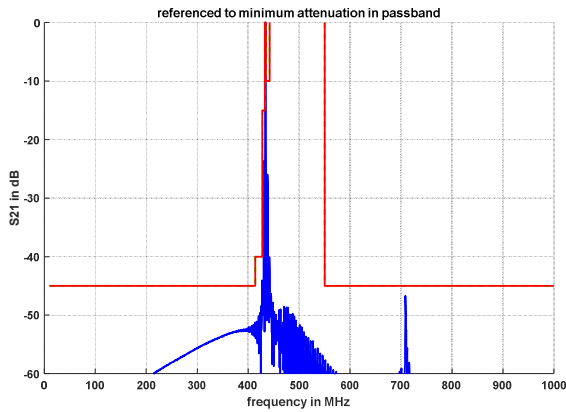

Construction and pin connection

(All dimensions in mm)

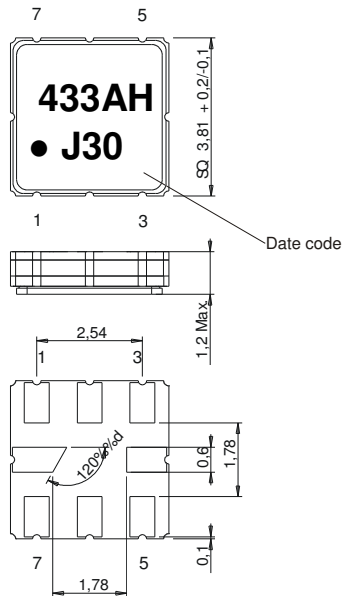

- 1 Ground
- 2 Input
- 3 Ground
- 4 Ground
- 5 Output
- 6 Ground
- 7 Ground
- 8 Ground

Date code: Year + week
 J 2017
 K 2018
 L 2019
 ...

50 Ω Test circuit

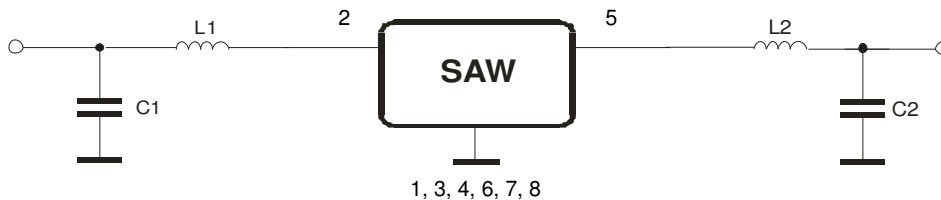

Vectron International GmbH
 Potsdamer Straße 18
 D 14 513 TELTOW / Germany
 Tel: (+49) 3328 4784-0 / Fax: (+49) 3328 4784-30
 E-Mail: tft@vectron.com

Vectron International GmbH reserves the right to make changes to the product(s) and/or information contained herein without notice. No liability is assumed as a result of their use or application. No rights under any patent accompany the sale of any such product(s) or information.

Stability characteristics, reliability

After the following tests the filter shall meet the whole specification:

1. Shock: 500 g, 1 ms, half sine wave, 3 shocks each plane;
DIN IEC 60068 T2 - 27
2. Vibration: 10 Hz to 2000 Hz, 0.35 mm or 5 g respectively, 1 octave per min, 10 cycles per plane, 3 planes; DIN IEC 60068 T2 - 6
3. Change of temperature: -55 °C to 125 °C / 15 min. each / 100 cycles
DIN IEC 60068 part 2 – 14 Test N
4. Resistance to solder heat (reflow): reflow possible: three times max.;
for temperature conditions refer to the attached "Air reflow temperature conditions" on page 4;
5. SAW devices are Electrostatic Discharge (ESD) sensitive devices.

This filter is RoHS compliant (2011/65/EU)

Packing

Tape & Reel: IEC 286 – 3, with exception of value for N and minimum bending radius;
tape type II, embossed carrier tape with top cover tape on the upper side;

reel of empty components at start: min. 300 mm
reel of empty components at start including leader: min. 500 mm
trailer: min. 300 mm

Tape (all dimensions in mm)

- W : 12.00 ±0.3
- Po : 4.00 ±0.1
- Do : 1.50 +0.1/-0
- E : 1.75 ±0.1
- F : 5.50 ±0.05
- G(min) : 0.75
- P2 : 2.00 ±0.05
- P1 : 8.00 ±0.1
- D1(min) : 1.50
- Ao : 4.30 ±0.1
- Bo : 4.30 ±0.1
- Ct : 9.2 ±0.1
- Ko : 1.80 ±0.1
- t : 0.30 ±0.05

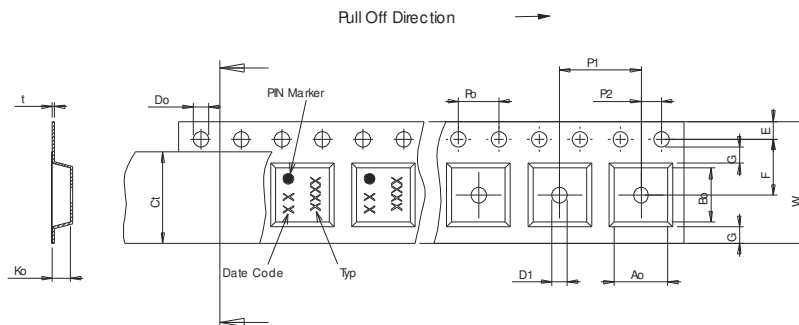

Reel (all dimensions in mm)

- A : 330 or 180
- W1 : 12.4 +2/-0
- W2(max) : 18.40
- N(min) : 50.00
- C : 13.0 +0.5/-0.2

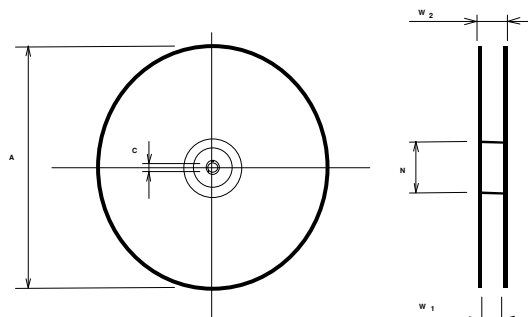

The minimum bending radius is 45 mm.

Vectron International GmbH
Potsdamer Straße 18
D 14 513 TELTOW / Germany
Tel: (+49) 3328 4784-0 / Fax: (+49) 3328 4784-30
E-Mail: tft@vectron.com

Vectron International GmbH reserves the right to make changes to the product(s) and/or information contained herein without notice. No liability is assumed as a result of their use or application. No rights under any patent accompany the sale of any such product(s) or information.

Air reflow temperature conditions

Conditions	Exposure
Average ramp-up rate (30 °C to 217 °C)	less than 3 °C / second
> 100 °C	between 300 and 600 seconds
> 150 °C	between 240 and 500 seconds
> 217 °C	between 30 and 150 seconds
Peak temperature	max. 260 °C
Time within 5 °C of actual peak temperature	between 10 and 30 seconds
Cool-down rate (Peak to 50 °C)	less than 6 °C / second
Time from 30 °C to Peak temperature	no greater than 300 seconds

Chip-mount air reflow profile

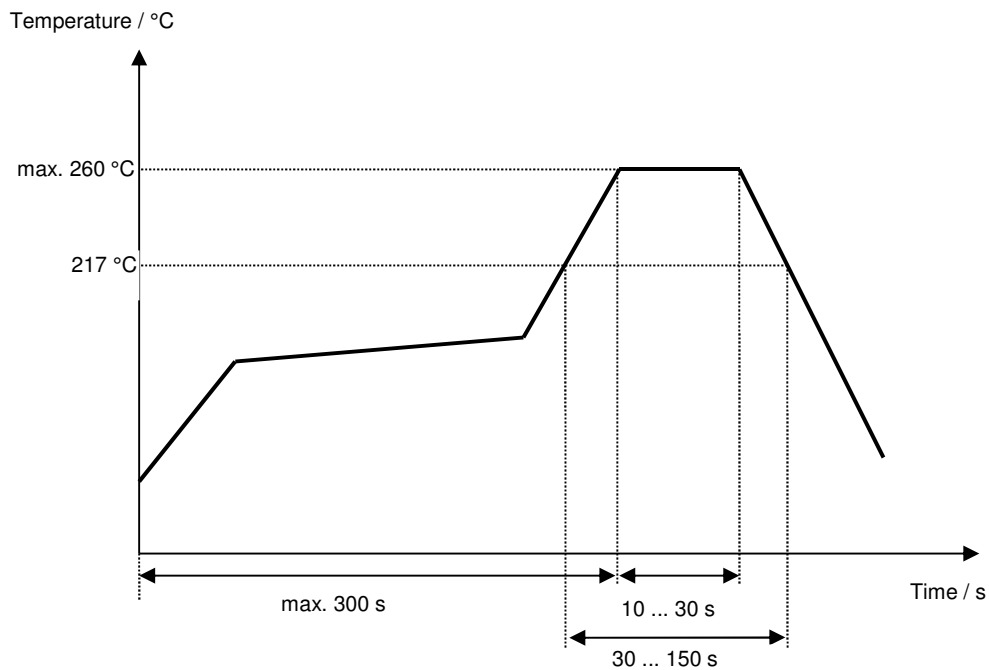

History

Version	Reason of Changes	Name	Date
1.0	Generation of filter specification.	Abutaimah	08.03.2017
1.1	update typos update storage temperature range update tape & reel	Schönbein	26.07.2017

Компания «Life Electronics» занимается поставками электронных компонентов импортного и отечественного производства от производителей и со складов крупных дистрибьюторов Европы, Америки и Азии.

С конца 2013 года компания активно расширяет линейку поставок компонентов по направлению коаксиальный кабель, кварцевые генераторы и конденсаторы (керамические, пленочные, электролитические), за счёт заключения дистрибьюторских договоров

Мы предлагаем:

- Конкуренспособные цены и скидки постоянным клиентам.
- Специальные условия для постоянных клиентов.
- Подбор аналогов.
- Поставку компонентов в любых объемах, удовлетворяющих вашим потребностям.
- Приемлемые сроки поставки, возможна ускоренная поставка.
- Доставку товара в любую точку России и стран СНГ.
- Комплексную поставку.
- Работу по проектам и поставку образцов.
- Формирование склада под заказчика.
- Сертификаты соответствия на поставляемую продукцию (по желанию клиента).
- Тестирование поставляемой продукции.
- Поставку компонентов, требующих военную и космическую приемку.
- Входной контроль качества.
- Наличие сертификата ISO.

В составе нашей компании организован Конструкторский отдел, призванный помогать разработчикам, и инженерам.

Конструкторский отдел помогает осуществить:

- Регистрацию проекта у производителя компонентов.
- Техническую поддержку проекта.
- Защиту от снятия компонента с производства.
- Оценку стоимости проекта по компонентам.
- Изготовление тестовой платы монтаж и пусконаладочные работы.



Тел: +7 (812) 336 43 04 (многоканальный)

Email: org@lifeelectronics.ru