

MAX9107/MAX9108/MAX9109

25ns, Dual/Quad/Single, Low-Power, TTL Comparators

General Description

The MAX9107/MAX9108/MAX9109 dual/quad/single, high-speed, low-power voltage comparators are designed for use in systems powered from a single +5V supply. Their 25ns propagation delay (with 10mV input overdrive) is achieved with a power consumption of only 1.75mW per comparator. The wide input common-mode range extends from 200mV below ground to within 1.5V of the positive supply rail.

The MAX9107/MAX9108/MAX9109 outputs are TTL-compatible, requiring no external pullup circuitry. These easy-to-use comparators incorporate internal hysteresis to ensure clean output switching even when the devices are driven by a slow-moving input signal.

The MAX9107/MAX9108/MAX9109 are higher-speed, lower-power, lower-cost upgrades to industry-standard comparators MAX907/MAX908/MAX909. The MAX9109 features an output latch but does not have complementary outputs.

The dual MAX9107 is available in both 8-pin SO and SOT23 packages. The quad MAX9108 is available in 14-pin TSSOP and SO packages while the single MAX9109 is available in an ultra-small 6-pin SC70 package, a space-saving 6-pin SOT23 package and an 8-pin SO package.

Applications

- Battery Powered Systems
- A/D Converters
- Line Receivers
- Threshold Detectors/Discriminators
- Sampling Circuits
- Zero-Crossing Detectors

Features

- 25ns Propagation Delay
- 350µA (1.75mW) Supply Current Per Comparator
- Single 4.5V to 5.5V Supply Operation
- Wide Input Range Includes Ground
- Low 500µV Offset Voltage
- Internal Hysteresis Provides Clean Switching (2mV)
- TTL-Compatible Outputs
- Internal Latch (MAX9109 only)
- Space-Saving Packages:
 - 6-Pin SC70 (MAX9109)
 - 8-Pin SOT23 (MAX9107)
 - 14-Pin TSSOP (MAX9108)

Ordering Information

PART	PIN-PACKAGE	TOP MARK	PKG CODE
MAX9107EKA+T	8 SOT23-8	AAIB	K8-5
MAX9107ESA+	8 SO	—	S8-2
MAX9108EUD+	14 TSSOP	—	U14-1
MAX9108ESD+	14 SO	—	S14-1
MAX9109EXT+T	6 SC70-6	AAU	X6S-1
MAX9109EUT+T	6 SOT23-6	AARU	U6-1
MAX9109ESA+	8 SO	—	S8-2

Note: All devices are specified over the -40°C to +85°C operating temperature range.

Pin Configurations

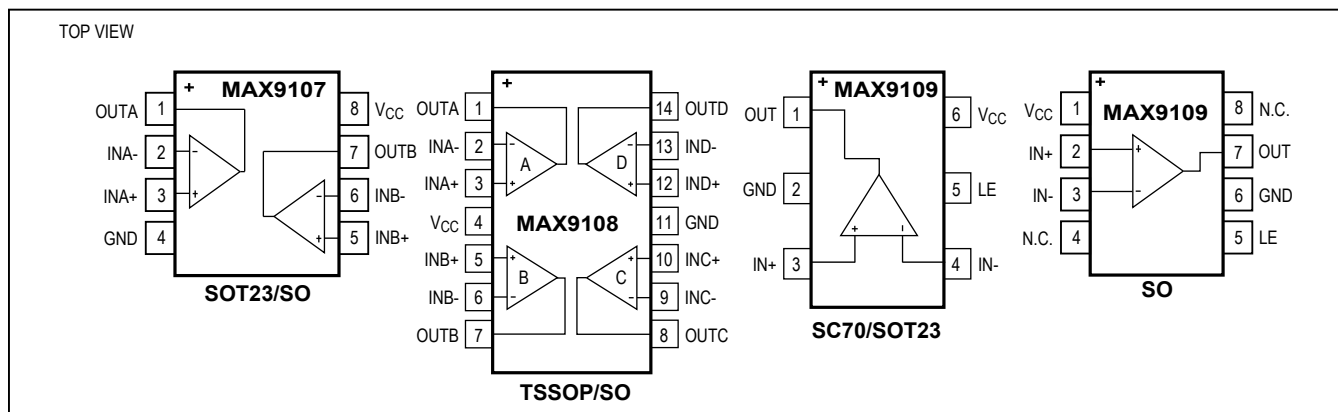

Absolute Maximum Ratings

Power-Supply Ranges

- Supply Voltage (V_{CC} to GND)6V
- Differential Input Voltage-0.3V to ($V_{CC} + 0.3V$)
- Common-Mode Input Voltage to GND..-0.3V to ($V_{CC} + 0.3V$)
- Latch-Enable Input Voltage
(MAX9109 only).....-0.3V to ($V_{CC} + 0.3V$)
- Current into Input Pins $\pm 20mA$
- Output Short-Circuit Duration to V_{CC} or GND 10s
- Continuous Power Dissipation ($T_A = +70^\circ C$)
 - 6-Pin SC70 (derate 3.1mW/ $^\circ C$ above $+70^\circ C$).....245mW
 - 6-Pin SOT23 (derate 8.7mW/ $^\circ C$ above $+70^\circ C$)696mW

- 8-Pin SOT23 (derate 9.1mW/ $^\circ C$ above $+70^\circ C$)727mW
- 8-Pin SO (derate 5.9mW/ $^\circ C$ above $+70^\circ C$).....470mW
- 14-Pin TSSOP (derate 9.1mW/ $^\circ C$ above $+70^\circ C$).....727mW
- 14-Pin SO (derate 8.33mW/ $^\circ C$ above $+70^\circ C$).....666mW
- Operating Temperature Range..... $-40^\circ C$ to $+85^\circ C$
- Storage Temperature Range..... $-65^\circ C$ to $+150^\circ C$
- Lead Temperature (soldering, 10s) $+300^\circ C$

Stresses beyond those listed under "Absolute Maximum Ratings" may cause permanent damage to the device. These are stress ratings only, and functional operation of the device at these or any other conditions beyond those indicated in the operational sections of the specifications is not implied. Exposure to absolute maximum rating conditions for extended periods may affect device reliability.

Electrical Characteristics

($V_{CC} = +5V$, $V_{CM} = 0$, $V_{LE} = 0$ (MAX9109 only), $T_A = T_{MIN}$ to T_{MAX} , unless otherwise noted. Typical values are at $T_A = +25^\circ C$.) (Note 1)

PARAMETER	SYMBOL	CONDITIONS	MIN	TYP	MAX	UNITS	
Operating Voltage Range	V_{CC}	Guaranteed by PSRR	4.5		5.5	V	
Input Offset Voltage	V_{OS}	(Note 2)	$T_A = +25^\circ C$		0.5	1.6	mV
			$T_A = T_{MIN}$ to T_{MAX}			4.0	
Input Hysteresis	V_{HYST}	(Note 3)		2		mV	
Input Bias Current	I_B			125	350	nA	
Input Offset Current	I_{OS}			25	80	nA	
Input Voltage Range	V_{CMR}	(Note 4)	-0.2		$V_{CC} - 1.5$	V	
Common-Mode Rejection Ratio	CMRR	$V_{CC} = 5.5V$ (Note 5)		50	1000	$\mu V/V$	
Power-Supply Rejection Ratio	PSRR	$4.5V \leq V_{CC} \leq 5.5V$		50	1000	$\mu V/V$	
Output High Voltage	V_{OH}	$I_{SOURCE} = 100\mu A$	3.0	3.5		V	
Output Low Voltage	V_{OL}	$I_{SINK} = 3.2mA$		0.35	0.6	V	
		$I_{SINK} = 8mA$		0.4			
Supply Current Per Comparator	I_{CC}	$V_{CC} = +5.5V$, all outputs low		0.35	0.7	mA	
Output Rise Time	t_r	$V_{OUT} = 0.4V$ to $2.4V$, $C_L = 10pF$		12		ns	
Output Fall Time	t_f	$V_{OUT} = 2.4V$ to $0.4V$, $C_L = 10pF$		6		ns	

Electrical Characteristics (continued)

($V_{CC} = +5V$, $V_{CM} = 0$, $V_{LE} = 0$ (MAX9109 only), $T_A = T_{MIN}$ to T_{MAX} , unless otherwise noted. Typical values are at $T_A = +25^\circ C$.) (Note 1)

PARAMETER	SYMBOL	CONDITIONS	MIN	TYP	MAX	UNITS
Propagation Delay	t_{PD+} , t_{PD-}	$V_{IN} = 100mV$, $V_{OD} = 10mV$		25		ns
Differential Propagation Delay	Δt_{PD}	$V_{IN} = 100mV$, $V_{OD} = 10mV$ (Note 6)		1		ns
Propagation Delay Skew	t_{PDskew}	$V_{IN} = 100mV$, $V_{OD} = 10mV$ (Note 7)		5		ns
Latch Input Voltage High	V_{IH}	(Note 8)	2.0			V
Latch Input Voltage Low	V_{IL}	(Note 8)			0.8	V
Latch Input Current	I_{IH} , I_{IL}	(Note 8)		0.4	1	μA
Latch Setup Time	t_s	(Note 8)		2		ns
Latch Hold Time	t_h	(Note 8)		2		ns

Note 1: Devices are 100% production tested at $T_A = +25^\circ C$. All temperature limits are guaranteed by design.

Note 2: Input Offset Voltage is defined as the center of the input-referred hysteresis zone. Specified for $V_{CM} = 0$. See Figure 1.

Note 3: Trip Point is defined as the input voltage required to make the comparator output change state. The difference between upper (V_{TRIP+}) and lower (V_{TRIP-}) trip points is equal to the width of the input-referred hysteresis zone (V_{HYST}). Specified for an input common-mode voltage (V_{CM}) of 0. See Figure 1.

Note 4: Inferred from the CMRR test. Note that a correct logic result is obtained at the output, provided that at least one input is within the V_{CMR} limits. Note also that either or both inputs can be driven to the upper or lower absolute maximum limit without damage to the part.

Note 5: Tested over the full-input voltage range (V_{CMR}).

Note 6: Differential Propagation Delay is specified as the difference between any two channels in the MAX9107/MAX9108 (both outputs making either a low-to-high or a high-to-low transition).

Note 7: Propagation Delay Skew is specified as the difference between any single channel's output low-to-high transition (t_{PD+}) and high-to-low transition (t_{PD-}).

Note 8: Latch specifications apply to MAX9109 only. See Figure 2.

Typical Operating Characteristics

($V_{CC} = 5V$, $V_{CM} = 0$, $C_L = 15pF$, $T_A = +25^\circ C$, unless otherwise noted.)

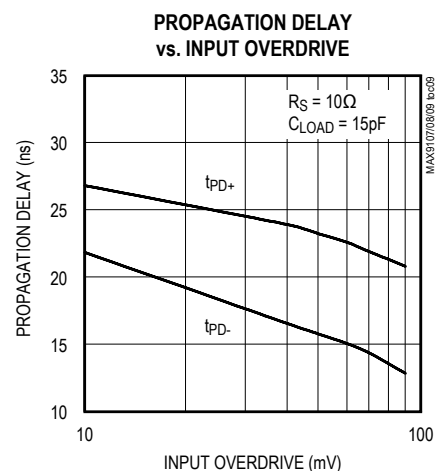
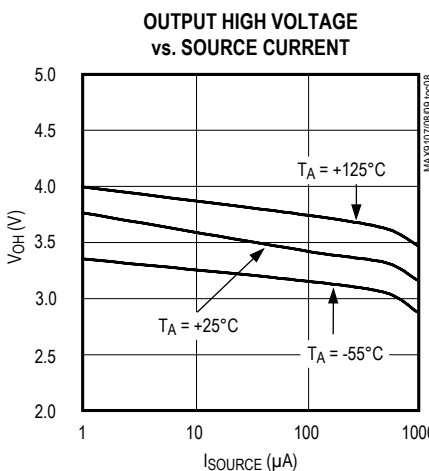
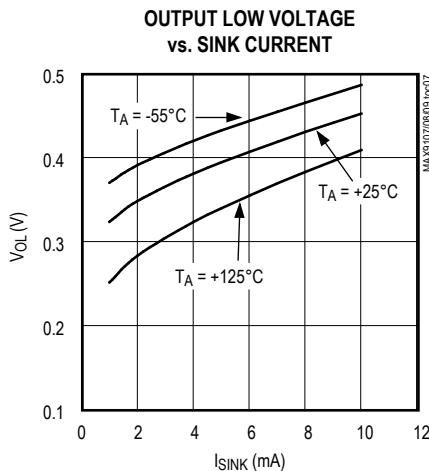
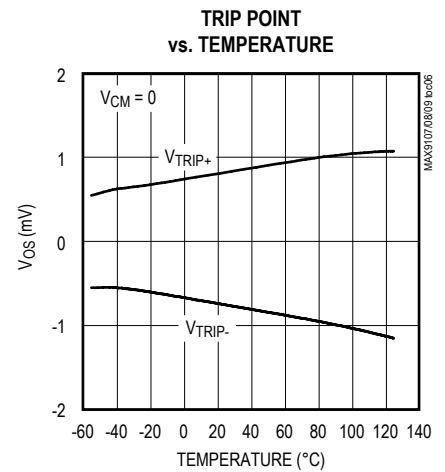
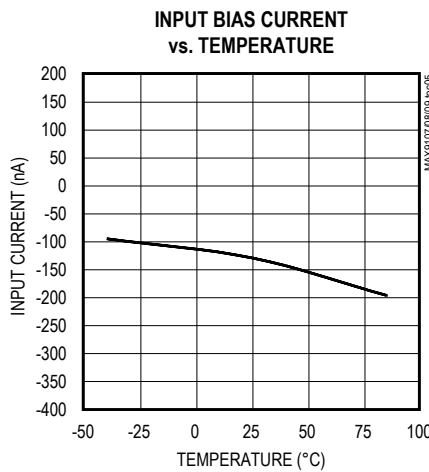
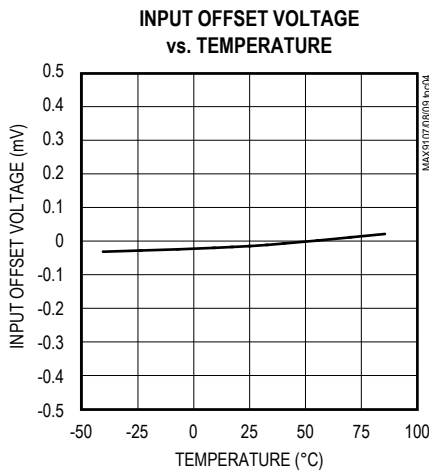
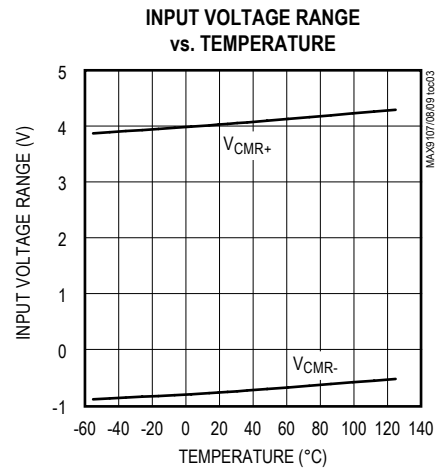
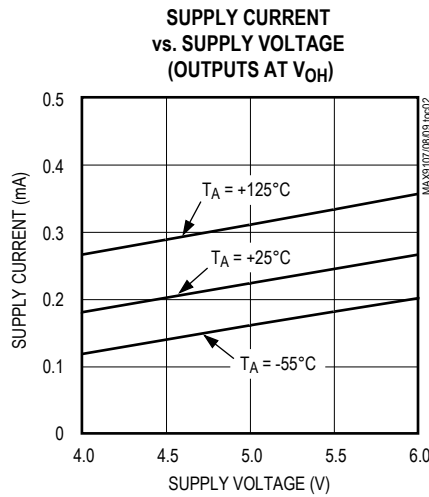
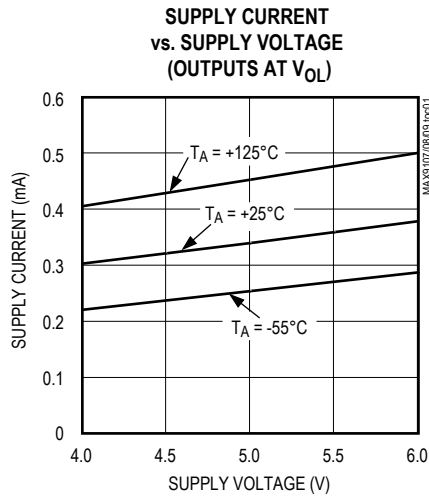

Typical Operating Characteristics (continued)

($V_{CC} = 5V$, $V_{CM} = 0$, $C_L = 15pF$, $T_A = +25^\circ C$, unless otherwise noted.)

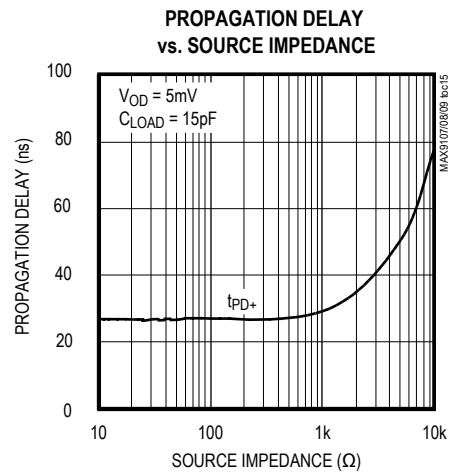
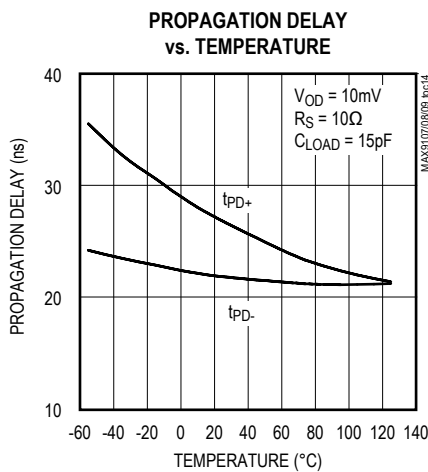
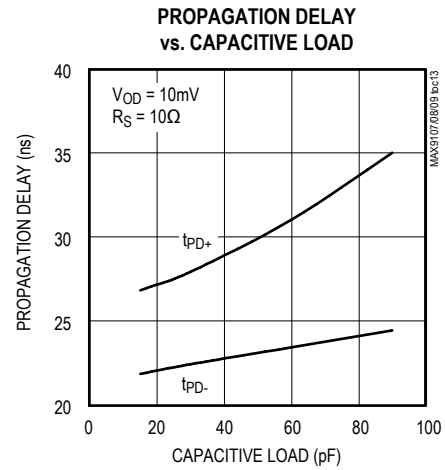
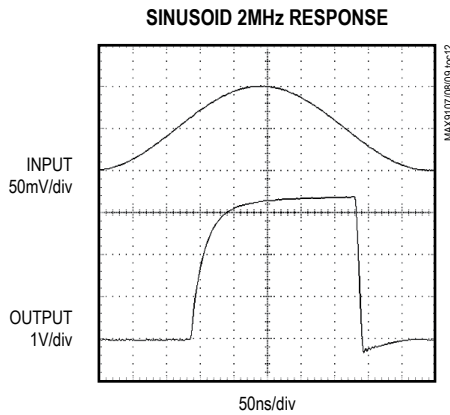
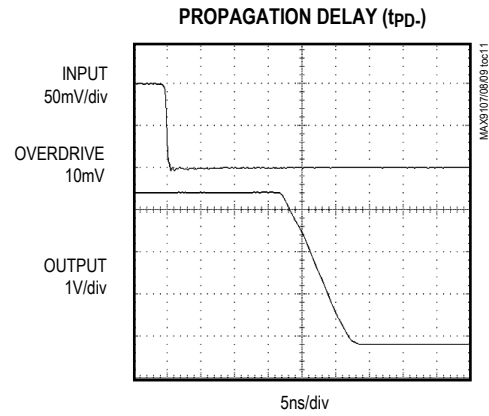
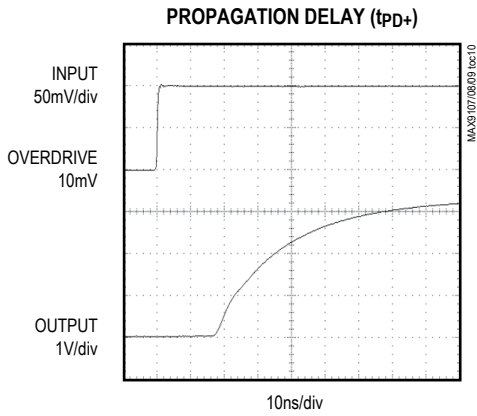

Pin Description

		PIN		NAME	FUNCTION
MAX9107	MAX9108	MAX9109			
		SC70/SOT23	SO		
1	1	—	—	OUTA	Channel A Output
2	2	—	—	INA-	Channel A Inverting Input
3	3	—	—	INA+	Channel A Noninverting Input
7	7	—	—	OUTB	Channel B Output
6	6	—	—	INB-	Channel B Inverting Input
5	5	—	—	INB+	Channel B Noninverting Input
—	8	—	—	OUTC	Channel C Output
—	9	—	—	INC-	Channel C Inverting Input
—	10	—	—	INC+	Channel C Noninverting Input
—	14	—	—	OUTD	Channel D Output
—	13	—	—	IND-	Channel D Inverting Input
—	12	—	—	IND+	Channel D Noninverting Input
—	—	1	7	OUT	Output
—	—	3	2	IN+	Noninverting Input
—	—	4	3	IN-	Inverting Input
8	4	6	1	V _{CC}	Positive Supply
4	11	2	6	GND	Ground
—	—	5	5	LE	Latch Enable. The latch is transparent when LE is low.
—	—	—	4, 8	N.C.	No Connection. Not internally connected.

Detailed Description

Timing

Noise or undesired parasitic AC feedback cause most high-speed comparators to oscillate in the linear region (i.e., when the voltage on one input is at or near the voltage on the other input). The MAX9107/MAX9108/MAX9109 eliminate this problem by incorporating an internal hysteresis of 2mV. When the two comparator input voltages are equal, hysteresis effectively causes one comparator input voltage to move quickly past the other, thus taking the input out of the region where oscillation occurs. Standard comparators require that hysteresis be added through the use of external resistors. The MAX9107/MAX9108/MAX9109's fixed internal hysteresis eliminates these resistors. To increase hysteresis and noise margin even more, add positive feedback

with two resistors as a voltage divider from the output to the noninverting input.

Adding hysteresis to a comparator creates two trip points: one for the input voltage rising and one for the input voltage falling (Figure 1). The difference between these two input-referred trip points is the hysteresis. The average of the trip points is the offset voltage.

Figure 1 illustrates the case where IN- is fixed and IN+ is varied. If the inputs were reversed, the figure would look the same, except the output would be inverted.

The MAX9109 includes an internal latch, allowing the result of a comparison to be stored. If LE is low, the latch is transparent (i.e., the comparator operates as though the latch is not present). The state of the comparator output is latched when LE is high (Figure 2).

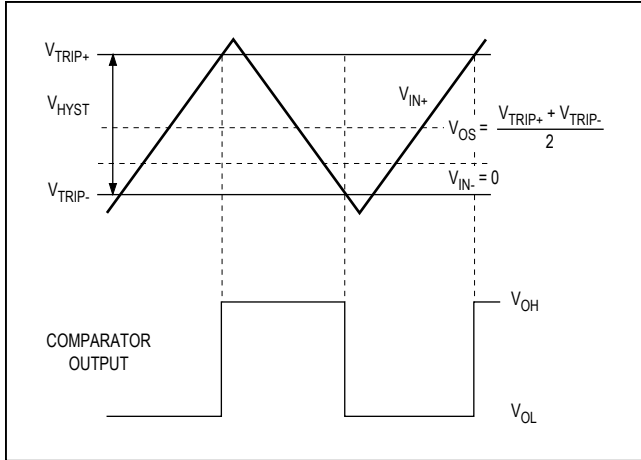

Figure 1. Input and Output Waveforms, Noninverting Input Varied

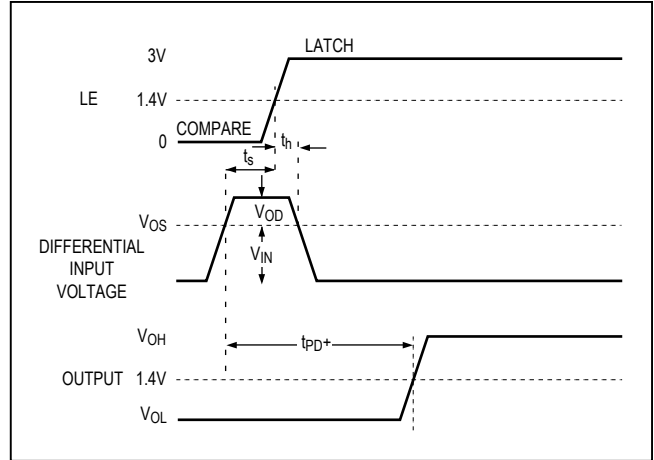

Figure 2. MAX9109 Timing Diagram

Applications Information

Circuit Layout

Because of the MAX9107/MAX9108/MAX9109's high gain bandwidth, special precautions must be taken to realize the full high-speed capability. A printed circuit board with a good, low-inductance ground plane is mandatory. Place the decoupling capacitor (a 0.1µF ceramic capacitor is a good choice) as close to V_{CC} as possible. Pay close attention to the decoupling capacitor's bandwidth, keeping leads short. Short lead lengths on the inputs and outputs are also essential to avoid unwanted parasitic feedback around the comparators. Solder the device directly to the printed circuit board instead of using a socket.

Overdriving the Inputs

The inputs to the MAX9107/MAX9108/MAX9109 may be driven beyond the voltage limits given in the *Absolute Maximum Ratings*, as long as the current flowing into the device is limited to 25mA. However, if the inputs are overdriven, the output may be inverted. The addition of an external diode prevents this inversion by limiting the input voltage to 200mV to 300mV below ground (see Figure 3).

Battery-Operated Infrared Data Link

In Figure 4, the circuit allows reception of infrared data. The MAX4400 converts the photodiode current to a voltage, and the MAX9109 determines whether the amplifier output is high enough to be called a "1." The current consumption of this circuit is minimal: the MAX4400 and MAX9109 require typically 410µA and 350µA, respectively.

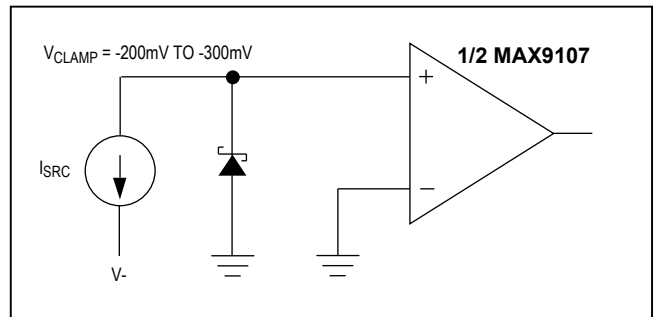

Figure 3. Schottky Clamp for Input Driven Below Ground

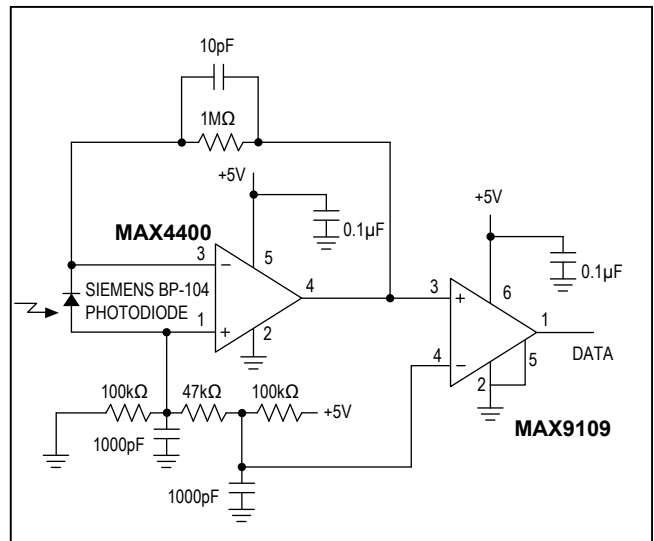

Figure 4. Battery-Operated Infrared Data Link Consumes Only 760µA

Chip Information

MAX9107 TRANSISTOR COUNT: 262

MAX9108 TRANSISTOR COUNT: 536

MAX9109 TRANSISTOR COUNT: 140

PROCESS: Bipolar

Package Information

For the latest package outline information and land patterns (footprints), go to www.maximintegrated.com/packages. Note that a "+", "#", or "-" in the package code indicates RoHS status only. Package drawings may show a different suffix character, but the drawing pertains to the package regardless of RoHS status.

PACKAGE TYPE	PACKAGE CODE	OUTLINE NO.	LAND PATTERN NO.
8 SOT23	K8-5	21-0041	90-0176
3 SC70	S8-2	21-0041	90-0096
8 SO	U14-1	21-0066	90-0113
14 SO	S14-1	21-0041	90-0112
6 SC70	X6SN-1	21-0077	90-0189
6 SOT23	U6-1	21-0058	90-0175

Revision History

REVISION NUMBER	REVISION DATE	DESCRIPTION	PAGES CHANGED
2	1/07	General Edits	1, 2, 9–13
3	3/18	Updated <i>Ordering Information</i> table	1

For pricing, delivery, and ordering information, please contact Maxim Direct at 1-888-629-4642, or visit Maxim Integrated's website at www.maximintegrated.com.

Maxim Integrated cannot assume responsibility for use of any circuitry other than circuitry entirely embodied in a Maxim Integrated product. No circuit patent licenses are implied. Maxim Integrated reserves the right to change the circuitry and specifications without notice at any time. The parametric values (min and max limits) shown in the Electrical Characteristics table are guaranteed. Other parametric values quoted in this data sheet are provided for guidance.

Компания «Life Electronics» занимается поставками электронных компонентов импортного и отечественного производства от производителей и со складов крупных дистрибьюторов Европы, Америки и Азии.

С конца 2013 года компания активно расширяет линейку поставок компонентов по направлению коаксиальный кабель, кварцевые генераторы и конденсаторы (керамические, пленочные, электролитические), за счёт заключения дистрибьюторских договоров

Мы предлагаем:

- Конкурентоспособные цены и скидки постоянным клиентам.
- Специальные условия для постоянных клиентов.
- Подбор аналогов.
- Поставку компонентов в любых объемах, удовлетворяющих вашим потребностям.
- Приемлемые сроки поставки, возможна ускоренная поставка.
- Доставку товара в любую точку России и стран СНГ.
- Комплексную поставку.
- Работу по проектам и поставку образцов.
- Формирование склада под заказчика.
- Сертификаты соответствия на поставляемую продукцию (по желанию клиента).
- Тестирование поставляемой продукции.
- Поставку компонентов, требующих военную и космическую приемку.
- Входной контроль качества.
- Наличие сертификата ISO.

В составе нашей компании организован Конструкторский отдел, призванный помогать разработчикам, и инженерам.

Конструкторский отдел помогает осуществить:

- Регистрацию проекта у производителя компонентов.
- Техническую поддержку проекта.
- Защиту от снятия компонента с производства.
- Оценку стоимости проекта по компонентам.
- Изготовление тестовой платы монтаж и пусконаладочные работы.



Тел: +7 (812) 336 43 04 (многоканальный)

Email: org@lifeelectronics.ru