

FEATURES/BENEFITS

The Series SD dual-phase relays are designed for all types of loads. The design incorporates two relays in a single package. The relays utilize optical isolation to protect the control from load transients. High-current models are excellent for motor and phase angle control. The 50A 600 Vac models are available with common control connector or individual control connector. Applications include motor control, heating control, uninterruptible power supplies, light dimmers, industrial and process control, and on/off controls of AC equipment. UL recognized. UL File Number: E1285555.

- Designed for all types of loads
- Dual output (two relays in one package)
- Faston terminals
- Connector for common or individual control
- Tight zero-cross window for low EMI
- High immunity to surges



Part Number	Description
SD24R50-06	12-280 Vac
SD24R50	12-280 Vac
SD24D40-06	12-280 Vac
SD24R40-06	12-280 Vac
SD24D50-06	12-280 Vac
SD48D40-06	24-500 Vac
SD48D50A	24-600 Vac
SD48D50A2	24-600 Vac

Part Number Explanation

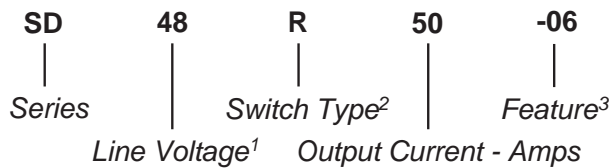

NOTES

- 1) Line Voltage (nominal): 24 = 240 Vac; 48 = 480 Vac
- 2) Switch Type: R = Random turn-on; D = Zero-cross turn-on;
- 3) Features: -06 = Faston terminals
A = Common control adapter
A2 = Individual control adapter

INPUT (CONTROL) SPECIFICATION

	Min	Max	Units
Control Range			
SD24	4	30	Vdc
SD48D40-06	5	30	Vdc
SD48D50XX	10	30	Vdc

Input Current Range

All relays (See Fig. 4a)	3		mA
--------------------------	---	--	----

Must Turn-Off Voltage

All relays	1		Vdc
------------	---	--	-----

Input Resistance (Typical)

SD24	1000	Ohms
SD48D40-06	1000	Ohms
SD48D50A	1400	Ohms
SD48D50A2	1800	Ohms

Reverse Voltage Protection

All relays	30		V
------------	----	--	---

BLOCK DIAGRAM

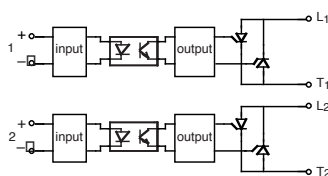

Figure 1a — All SD relays except SD48D40-06

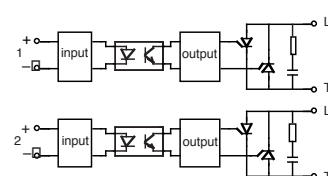

Figure 1b — SD48D40-06

MECHANICAL SPECIFICATION



Figure 2a — SD24R50-06, and SD24D50-06; dimensions in inches (mm)



Figure 2b — SD24R50; dimensions in inches (mm)

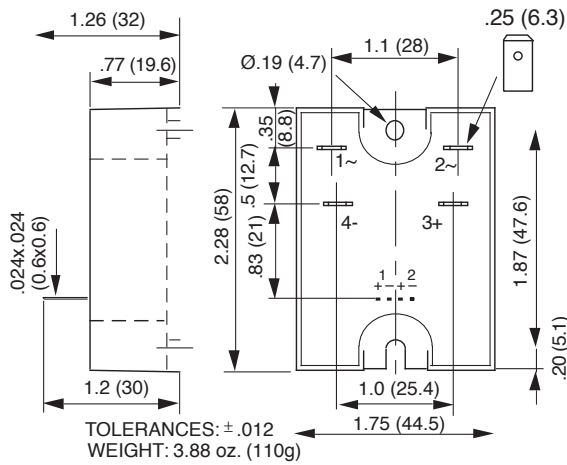

Figure 2c — SD48D40-06, SD24D40-06 and SD24R40-06; dimensions in inches (mm)



Figure 2d — SD48D50A; dimensions in inches (mm)



Figure 2e — SD48D50A2; dimensions in inches (mm)

TYPICAL APPLICATION

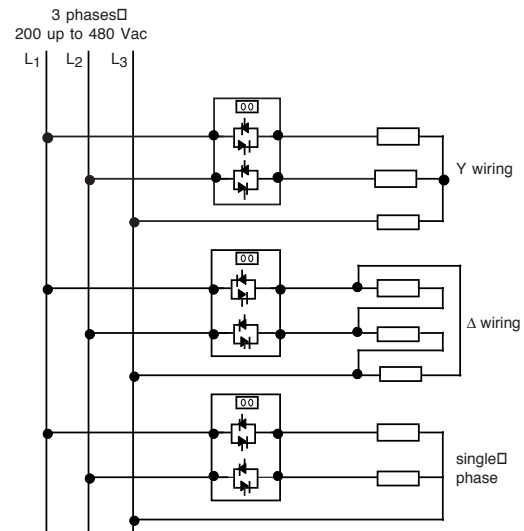

Figure 3 — SD48D50A

OUTPUT (LOAD) SPECIFICATION				
Input Type	Min	Max	Units	
Operating Range				
SD24	R/D	12	280	Vrms
SD48D40-06		24	510	Vrms
SD48D50XX		24	600	Vrms
Peak Voltage				
SD24			600	Vpeak
SD48			1200	Vpeak
Load Current Range (Resistive)				
SD24D40-06, SD24R40-06 & SD48D40-06				
		.005	40	Arms
All other relays		.005	50	Arms
Maximum Surge Current Rating (Non-Repetitive)				
SD24D40-06, SD24R40-06, & SD48D40-06				
			350	A
All other relays			550	A
On-State Voltage Drop				
All relays output current			1.6	V
Zero-Cross Window				
SD	R		NA	
SD	D/A		±12	Vac
Off-State Leakage Current (60Hz)				
SD48D40-06			2.5	mA
All other relays			1	mA
Turn-On Time (60 Hz)				
SD24	R		0.1	ms
All other relays			8.3	ms
Turn-Off Time (60 Hz)				
All relays			8.3	ms
SD24R40-06			10	ms

Input Type	Min	Max	Units
Off-State dv/dt			
All relays		500	V/μs
Maximum di/dt (Non-Repetitive)			
All relays		50	A/μs
Operating Frequency Range			
All relays	10	440	Hz
I²t for Match Fusing (<8.3ms)			
SD24D40-06, SD24R40-06 & SD48D40-06			612 A ² S
All other relays			1500 A ² S

CONTROL CHARACTERISTICS

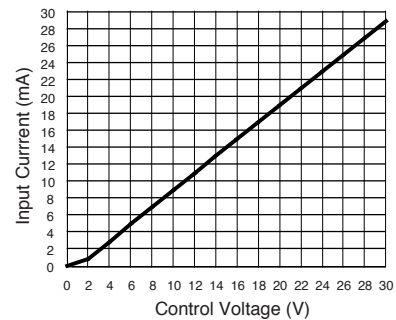

Figure 4a — SD24 and SD48D40-06 relays

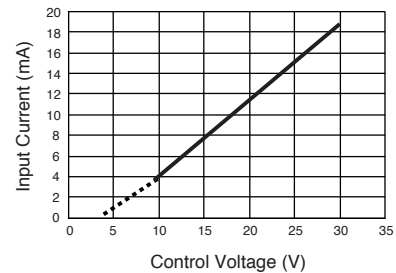

Figure 4b — SD48D50A relay

OUTPUT (LOAD) SPECIFICATION (Continued)

ENVIRONMENTAL SPECIFICATION

	Min	Max	Units
Operating Temperature	-40	100	°C
Storage Temperature	-40	100	°C

Input-Output Isolation

SD24D40-06, SD24R40-06 & SD48D40-06

	4000	Vrms
All other relays	3300	Vrms

Output-Case Isolation

SD24D40-06, SD24R40-06 & SD48D40-06

	2500	Vrms
All other relays	3300	Vrms

Output to Output

SD48D50XX	3300	Vrms
All other relays	2500	Vrms

Junction-Case Thermal Resistance

SD24D40-06, SD24R40-06 & SD48D40-06

	1.1	°C/W
All other relays	0.5	°C/W

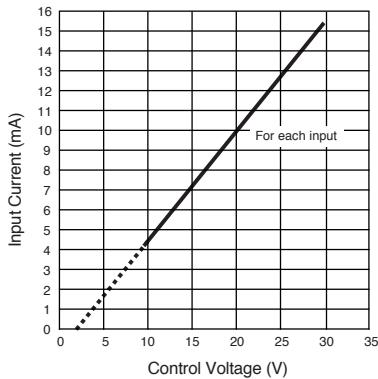

Figure 4c — SD48D50A2 relay

SURGE CURRENT

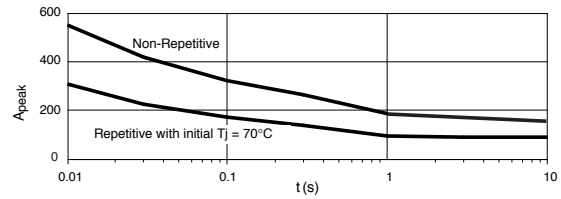

Figure 5a — SD24 50A output current

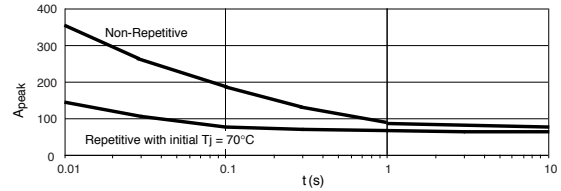

Figure 5b — SD48 40A and SD24 40A output current

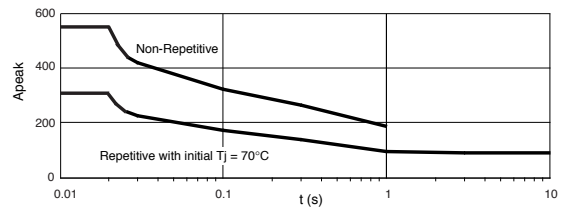

Figure 5c — SD48 50A output current

NOTES:

1. Electrical specifications at 25°C unless otherwise specified.
2. For 800Hz applications, contact factory.
3. For additional/custom applications, contact factory.

THERMAL CHARACTERISTICS

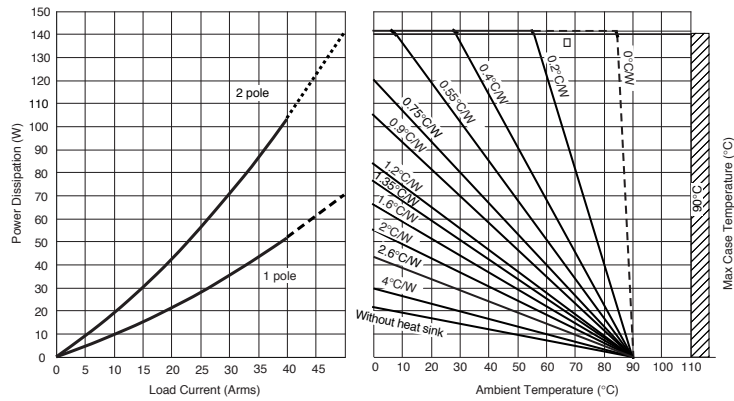

Figure 6a — SD24 50A relays output current

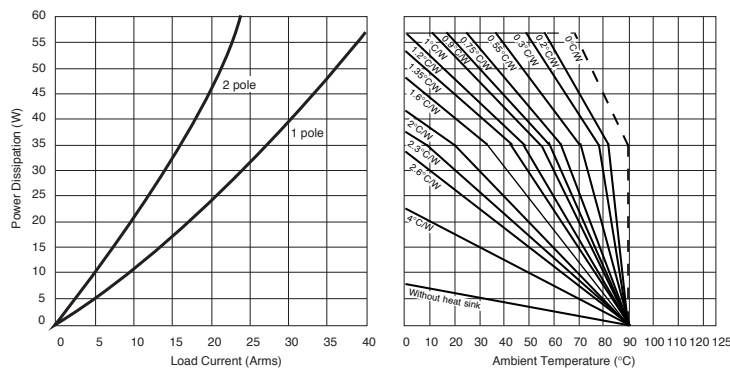

Figure 6b — SD48 40A and SD24 40A output current

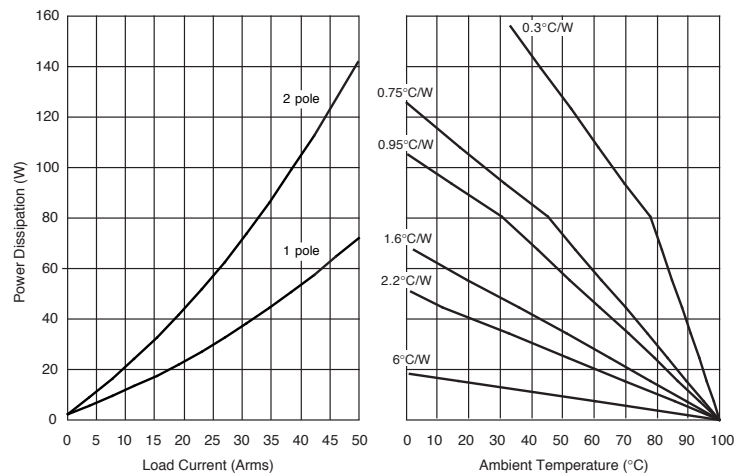

Figure 6c — SD48D50A and SD48D50A2 output current

OPTIONAL ADD-ONS

Please order add-ons separately:

- -12 — Thermal pad installed.
- -14 — Plastic touch-proof cover.

Компания «Life Electronics» занимается поставками электронных компонентов импортного и отечественного производства от производителей и со складов крупных дистрибьюторов Европы, Америки и Азии.

С конца 2013 года компания активно расширяет линейку поставок компонентов по направлению коаксиальный кабель, кварцевые генераторы и конденсаторы (керамические, пленочные, электролитические), за счёт заключения дистрибьюторских договоров

Мы предлагаем:

- Конкурентоспособные цены и скидки постоянным клиентам.
- Специальные условия для постоянных клиентов.
- Подбор аналогов.
- Поставку компонентов в любых объемах, удовлетворяющих вашим потребностям.
- Приемлемые сроки поставки, возможна ускоренная поставка.
- Доставку товара в любую точку России и стран СНГ.
- Комплексную поставку.
- Работу по проектам и поставку образцов.
- Формирование склада под заказчика.
- Сертификаты соответствия на поставляемую продукцию (по желанию клиента).
- Тестирование поставляемой продукции.
- Поставку компонентов, требующих военную и космическую приемку.
- Входной контроль качества.
- Наличие сертификата ISO.

В составе нашей компании организован Конструкторский отдел, призванный помогать разработчикам, и инженерам.

Конструкторский отдел помогает осуществить:

- Регистрацию проекта у производителя компонентов.
- Техническую поддержку проекта.
- Защиту от снятия компонента с производства.
- Оценку стоимости проекта по компонентам.
- Изготовление тестовой платы монтаж и пусконаладочные работы.



Тел: +7 (812) 336 43 04 (многоканальный)

Email: org@lifeelectronics.ru

www.lifeelectronics.ru