

RFUV1003

GaAs MMIC IQ UpConverter
12GHz to 16GHz

RFMD's RFUV1003 is a 12GHz to 16GHz GaAs pHEMT upconverter, incorporating an integrated LO buffer amplifier, a balanced single-side band (image rejection) mixer followed by a variable gain amplifier and DC decoupling capacitors. The combination of high performance part and low cost packaging makes the RFUV1003 a cost effective solution, ideally suited to both current and next generation Point-to-Point and VSAT applications. RFUV1003 is packaged in a 5mm x 5mm QFN to simplify both system level board design and volume assembly.

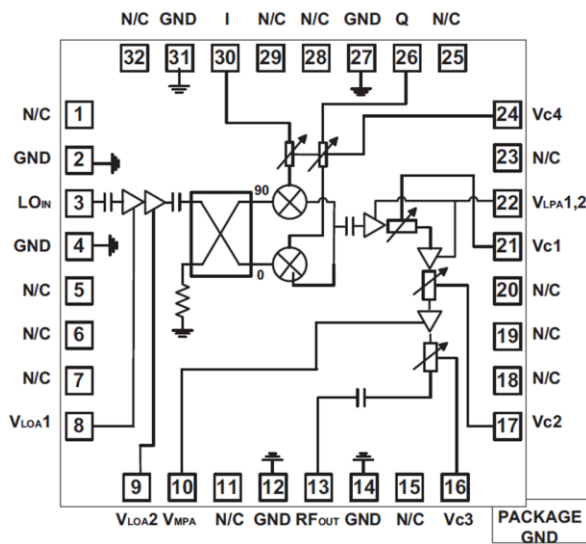

Functional Block Diagram

Ordering Information

RFUV1003S2	Sample bag with 2 pieces
RFUV1003SB	Bag with 5 pieces
RFUV1003SQ	Bag with 25 pieces
RFUV1003SR	7" Reel with 100 pieces
RFUV1003TR7	7" Reel with 750 pieces
RFUV1003TR13	13" Reel with 2500 pieces
RFUV1003PCK-410	Evaluation Board with 2-piece sample bag



Package: QFN, 32-pin,
5mm x 5mm x 0.95mm

Features

- RF Frequency: 12GHz to 16GHz
- LO Frequency: 8GHz to 20GHz
- IF Frequency: DC to 4GHz
- Maximum Conversion Gain: 23dB
- Minimum Conversion Gain: -10dB
- Noise Figure (Maximum Gain): 11dB
- Noise Figure (Minimum Gain): 17dB
- OIP3 (Maximum Gain): +28dBm
- OIP3 (Minimum Gain): +12dBm
- Image Rejection: 20dBc

Applications

- Point-to-Point
- VSAT

Absolute Maximum Ratings

Parameter	Rating	Unit
LPA Drain Voltage V_d	6	V
LOA Drain Voltage	6	V
RF Input Power	15	dBm
LO Input Power	15	dBm
T_{OPER}	-40 to +85	°C
T_{STOR}	-65 to +150	°C
ESD Human Body Model	Class 1A	



Caution! ESD sensitive device.



RFMD Green: RoHS compliant per EU Directive 2011/65/EU, halogen free per IEC 61249-2-21, <1000ppm each of antimony trioxide in polymeric materials and red phosphorus as a flame retardant, and <2% antimony solder.

Exceeding any one or a combination of the Absolute Maximum Rating conditions may cause permanent damage to the device. Extended application of Absolute Maximum Rating conditions to the device may reduce device reliability. Specified typical performance or functional operation of the device under Absolute Maximum Rating conditions is not implied.

Nominal Operating Parameters

Parameter	Specification			Unit	Condition
	Min	Typ	Max		
General Performance					
RF Frequency	12		16	GHZ	
LO Frequency	8		20	GHZ	
IF Frequency	DC		4	GHZ	
LO input Drive	-1	0	+5	dBm	
Conversion Gain (Max.)	20	23	24	dB	
Conversion Gain (Min.)	-9	-10	-11	dB	
NF (max. Gain)		11	13	dB	
NF (min. Gain)		17	21	dB	
OIP3 (max. Gain)	25	28		dBm	
OIP3 (min. Gain)	9	12		dBm	
Image Rejection	15	20		dBc	
LO Leakage at RF-Port (Maximum Gain)		-5	5	dBm	With IQ bias
LO Return Loss		10		dB	
RF Return Loss		10		dB	
V_D		5		V	
I_D		380	500	mA	
VVA	-4		0	V	

Typical Electrical Performance

Measurements performed with I and Q (IF) ports connected to an external 90° Hybrid, LO Power = 0dBm and IF = 2.5GHz, -10dBm unless otherwise stated

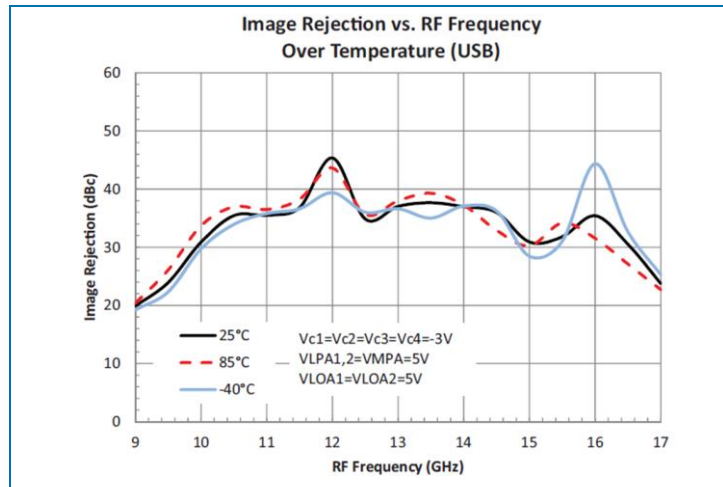
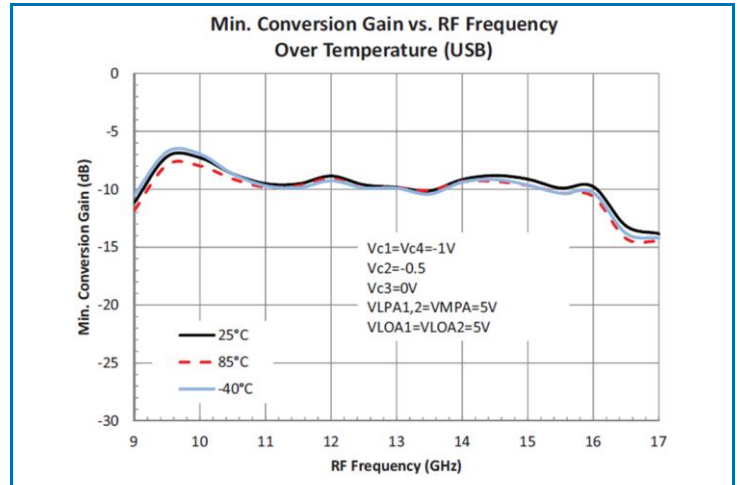
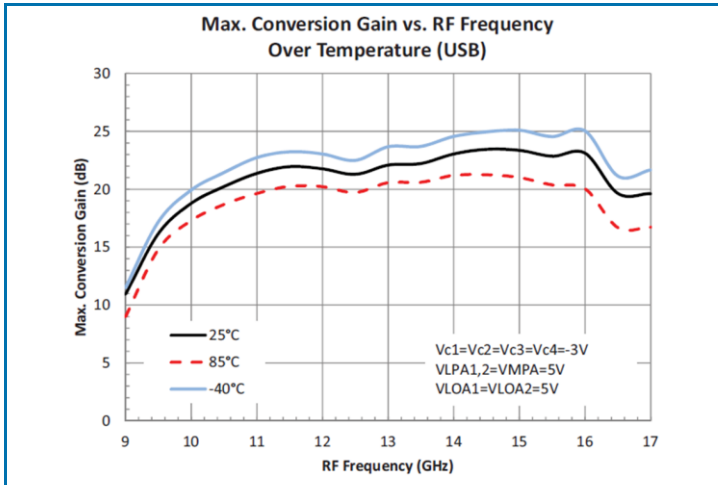

Typical Electrical Performance (continued)

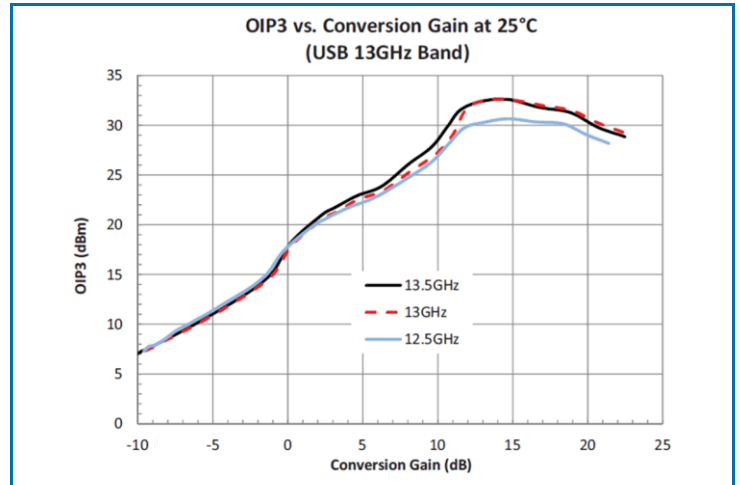
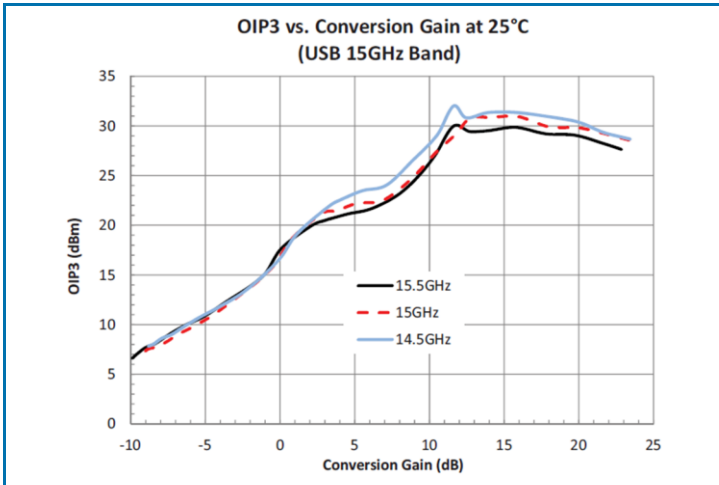
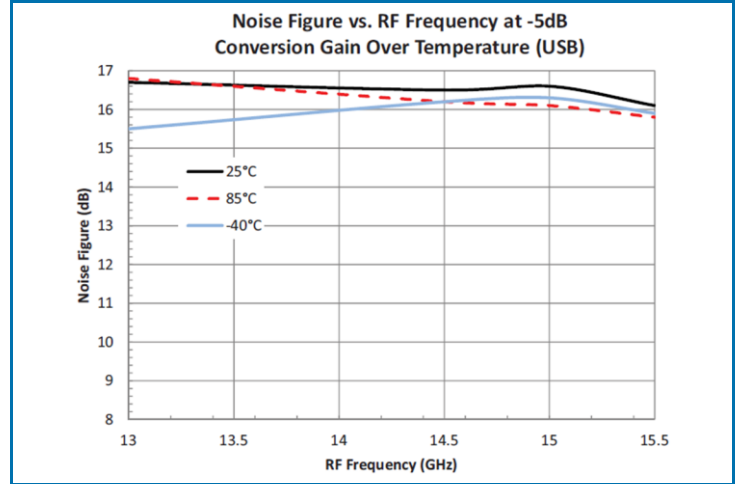
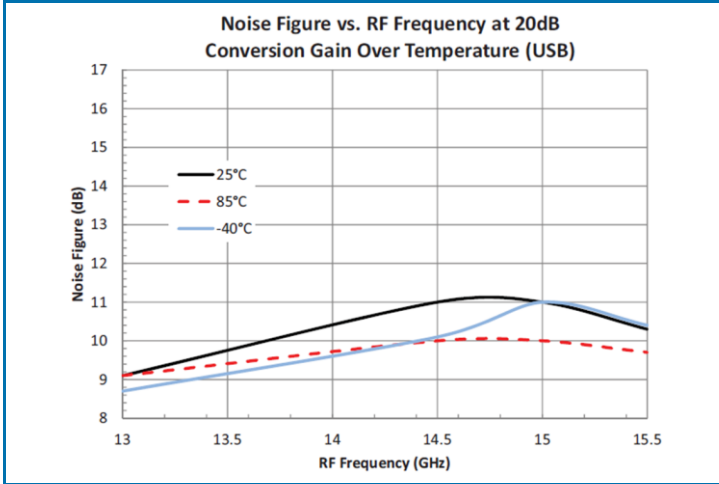

Typical Electrical Performance (continued)

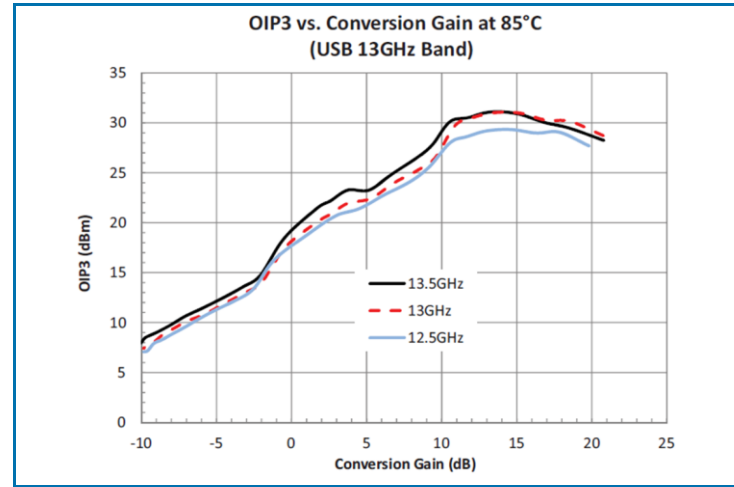
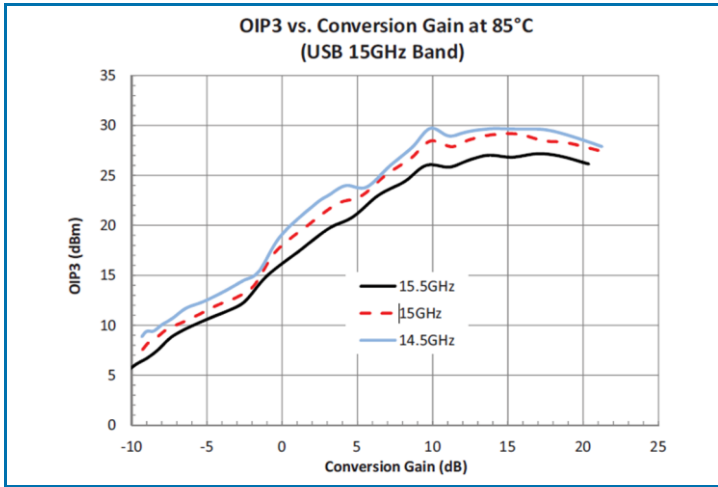
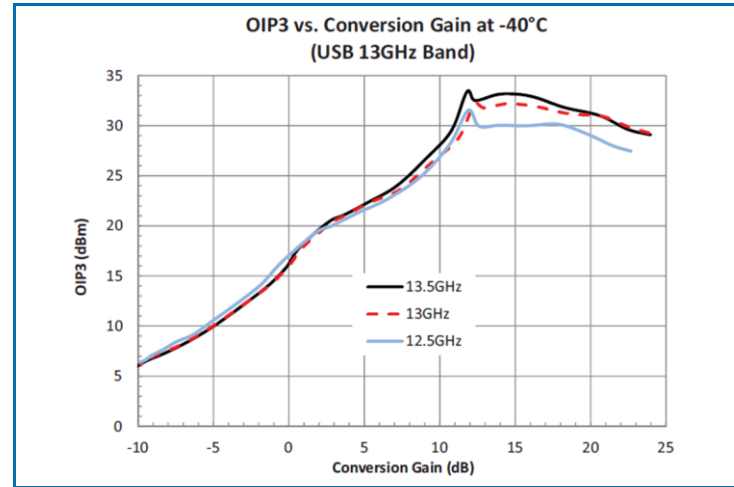
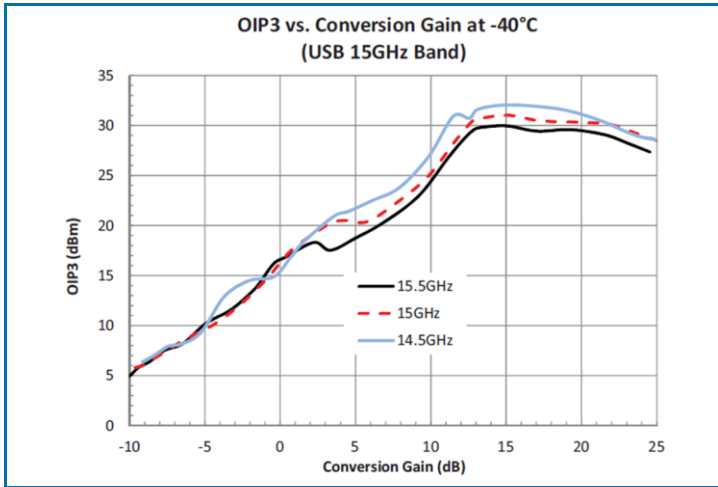

Typical Electrical Performance (continued)

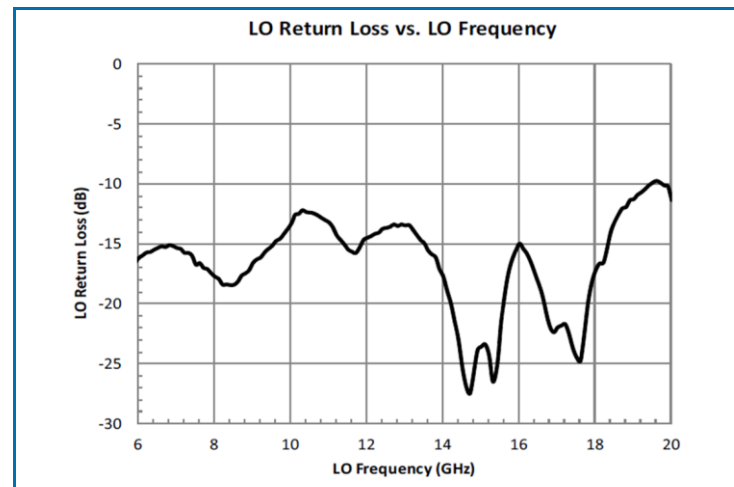
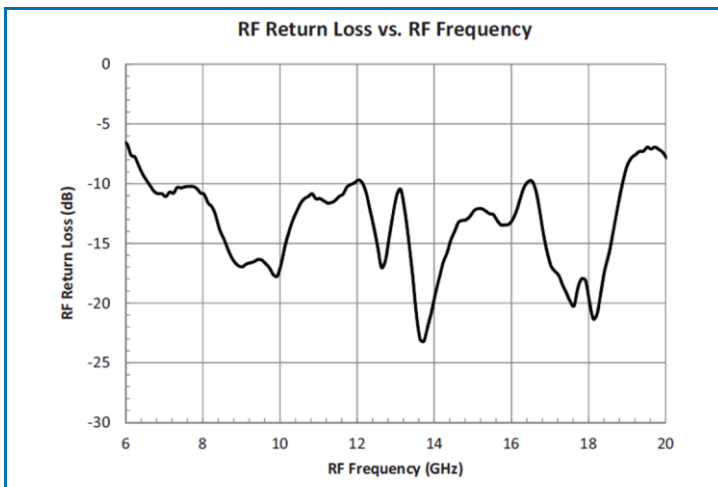
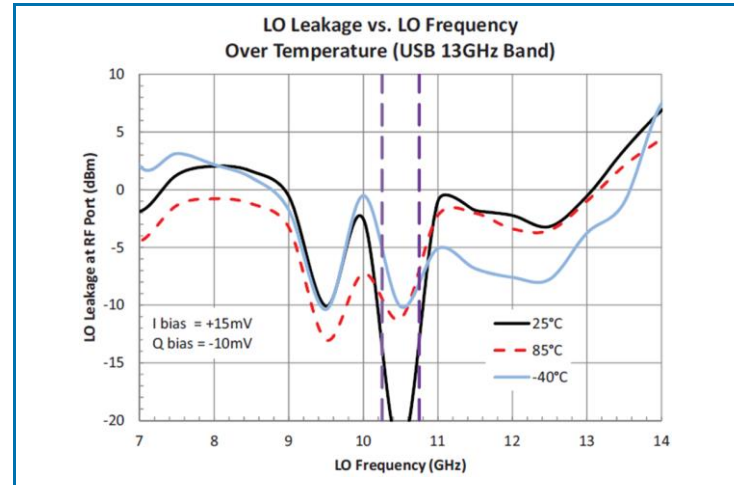
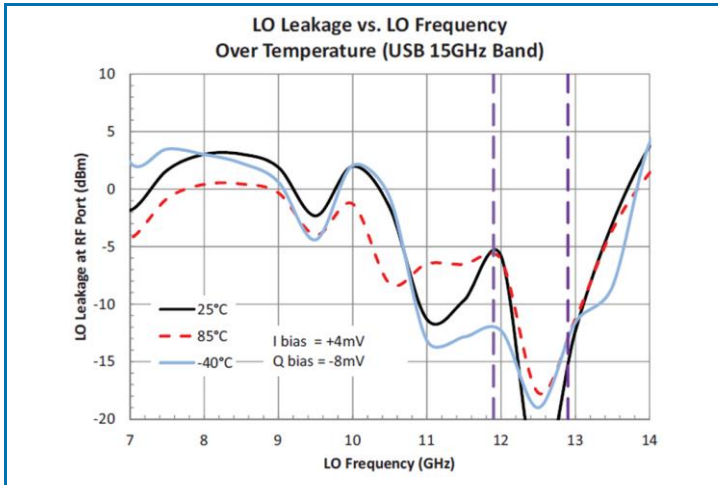

Typical Bias Sequence and Gain Control

Optimum linearity versus gain is achieved using sequential bias. At maximum gain (V_{C1} , V_{C4}), V_{C2} and V_{C3} are set at -4V. (V_{C1} , V_{C4}), V_{C2} and V_{C3} are biased in sequence. The first dynamic range is achieved by setting V_{C2} and V_{C3} at -4V and varying (V_{C1} , V_{C4}) over the (-4V to -1.25V) range as shown in the table below. Similarly second dynamic range is achieved by setting (V_{C1} , V_{C4}) at -1V, setting V_{C3} to -4V and varying V_{C2} over the (-2.5V to -1.25V) range. Finally third dynamic range is achieved by setting (V_{C1} , V_{C4}) and V_{C2} at -1V, and varying V_{C3} over the (-2.5V to -1V) range.

Bias Sequence 1 (Typical)

	Gmax																		Gmin
VC1, VC4	-4	-2.5	-2.25	-2	-1.75	-1.5	-1.25	-1	-1	-1	-1	-1	-1	-1	-1	-1	-1	-1	-1
VC2	-4	-4	-4	-4	-4	-4	-4	-2.5	-2.25	-2	-1.75	-1.5	-1.25	-1	-1	-1	-1	-1	-1
VC3	-4	-4	-4	-4	-4	-4	-4	-4	-4	-4	-4	-4	-4	-2.5	-2.25	-2	-1.75	-1.5	-1

Package Outline Drawing (Dimensions in millimeters)

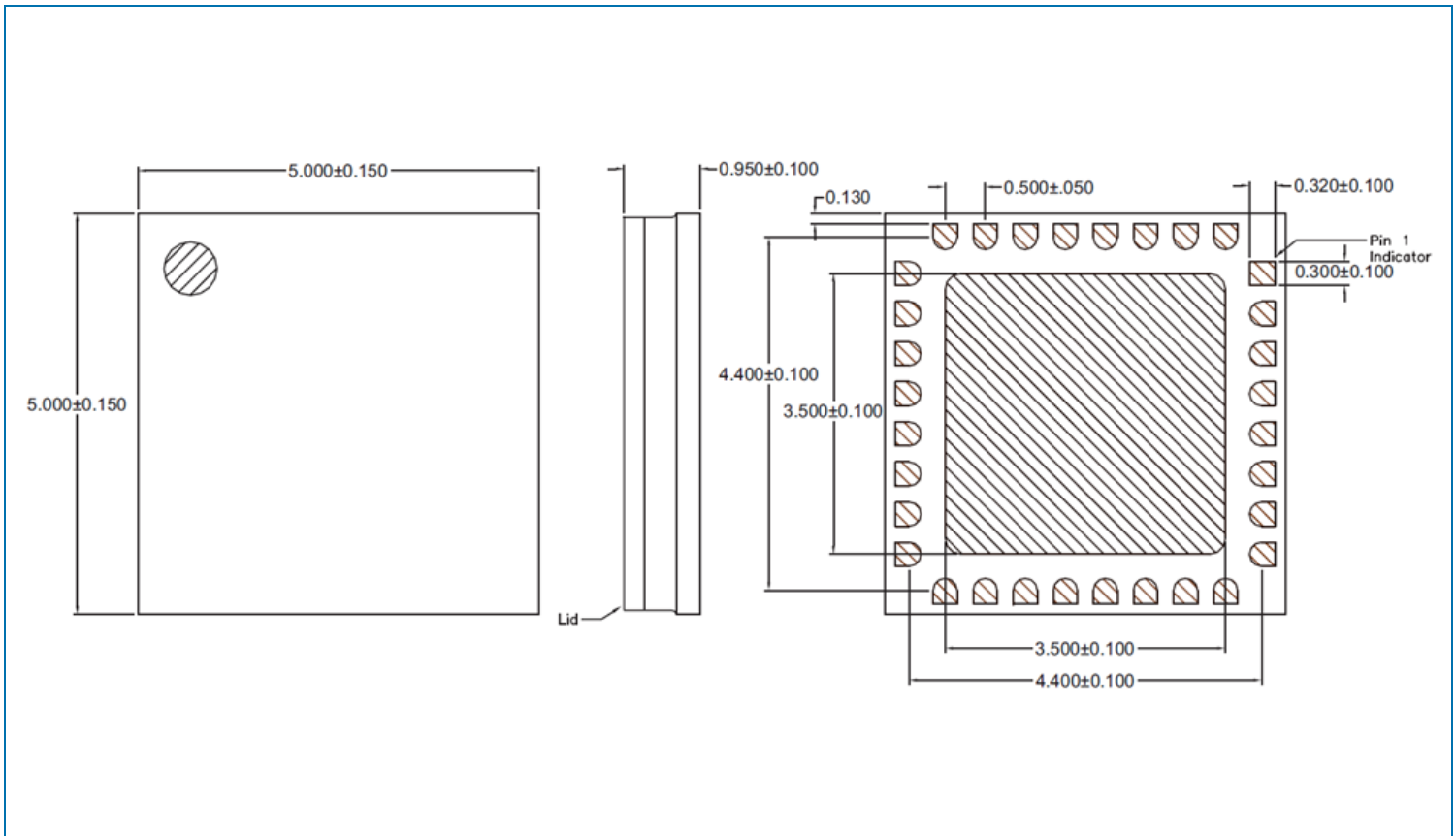

Pin Names and Descriptions

Pin	Name	Description
1	N/C	
2	GND	Ground
3	LO	Local oscillator input. AC coupled and matched to 50Ω
4	GND	Ground
5-7	N/C	
8	VLOA1	LOA stage 1 drain bias
9	VLOA2	LOA stage 2 drain bias
10	VMPA	MPA drain bias
11	N/C	
12	GND	Ground
13	RFOUT	RF output. AC coupled and matched to 50W
14	GND	Ground
15	N/C	
16	VC3	Control line number 3 (See bias sequence description)
17	VC2	Control line number 2 (See bias sequence description)
18-20	N/C	
21	VC1	Control line number 1 (See bias sequence description)
22	VLPA1, VLPA2	LPA stage 1,2 drain bias
23	N/C	
24	VC4	Control line number 4 (See bias sequence description)
25	N/C	
26	Q	IF Q input
27	GND	Ground
28-29	N/C	
30	I	If I input
31	GND	Ground
32	N/C	

Application Circuit Block Diagram

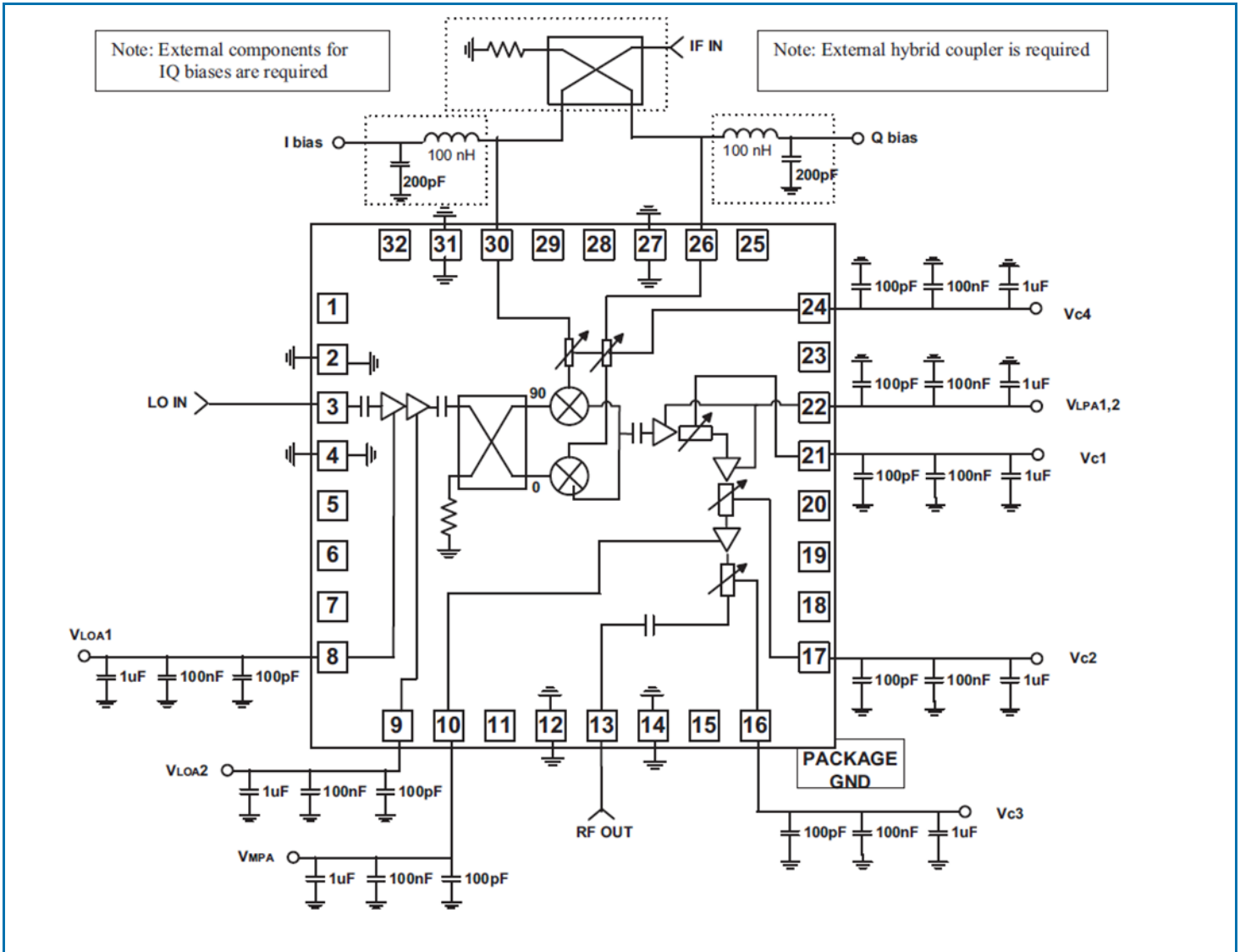

Evaluation Board Layout

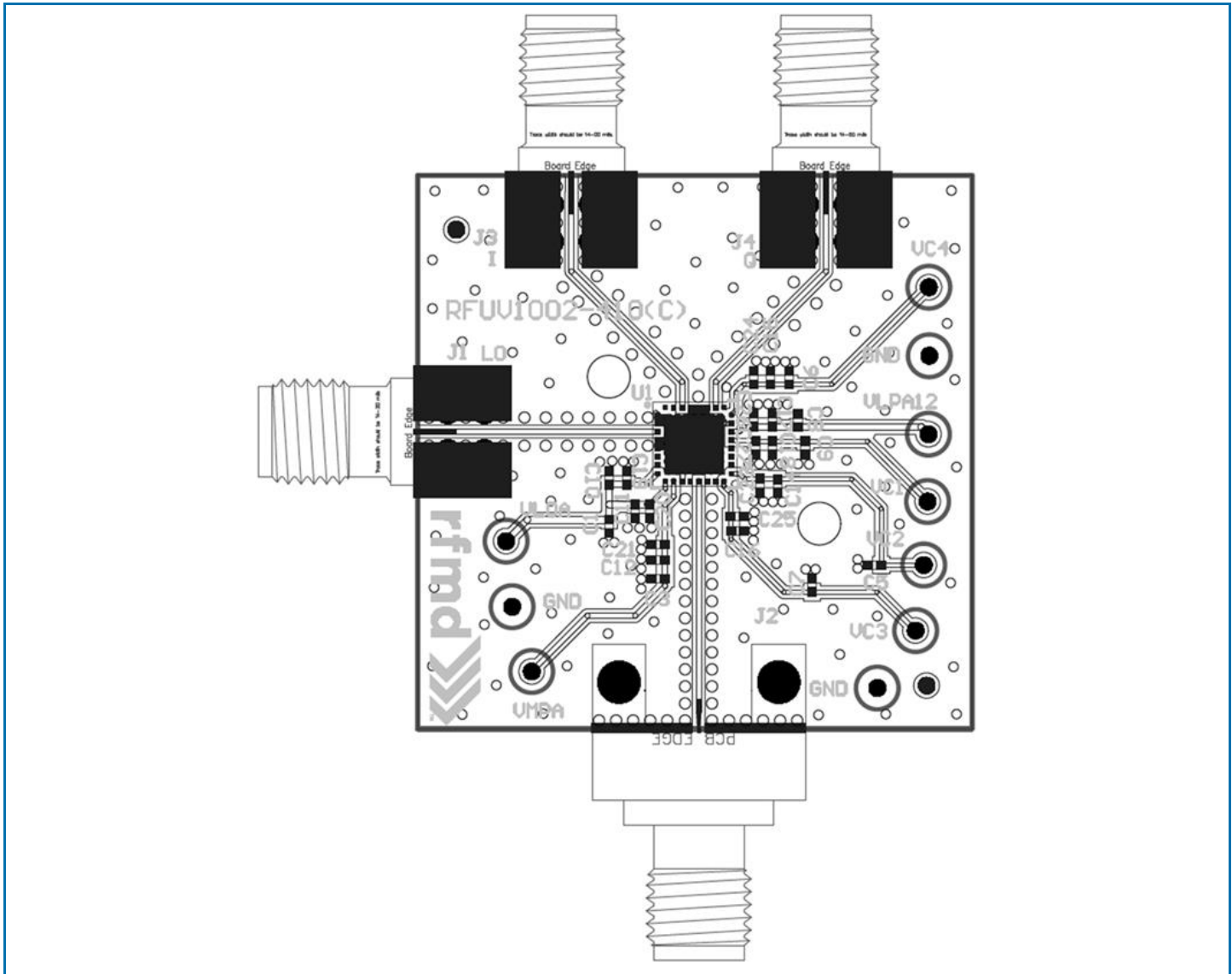

Test Condition	
LO Power	0dBm
IF Power	-10dBm
VLOA1, VLOA2	5V
VLPA1, VLPA2, VMPPA	5V
(Vc1, Vc4), Vc2, Vc3	-4V to 0V

Sub-Band Frequency Ranges	
Band	Frequency Range
10GHz	10GHz to 10.5GHz
11GHz	10.7GHz to 11.7GHz
13GHz	12.75GHz to 13.25GHz
15GHz	14.4GHz to 15.4GHz

Компания «Life Electronics» занимается поставками электронных компонентов импортного и отечественного производства от производителей и со складов крупных дистрибьюторов Европы, Америки и Азии.

С конца 2013 года компания активно расширяет линейку поставок компонентов по направлению коаксиальный кабель, кварцевые генераторы и конденсаторы (керамические, пленочные, электролитические), за счёт заключения дистрибьюторских договоров

Мы предлагаем:

- Конкурентоспособные цены и скидки постоянным клиентам.
- Специальные условия для постоянных клиентов.
- Подбор аналогов.
- Поставку компонентов в любых объемах, удовлетворяющих вашим потребностям.
- Приемлемые сроки поставки, возможна ускоренная поставка.
- Доставку товара в любую точку России и стран СНГ.
- Комплексную поставку.
- Работу по проектам и поставку образцов.
- Формирование склада под заказчика.
- Сертификаты соответствия на поставляемую продукцию (по желанию клиента).
- Тестирование поставляемой продукции.
- Поставку компонентов, требующих военную и космическую приемку.
- Входной контроль качества.
- Наличие сертификата ISO.

В составе нашей компании организован Конструкторский отдел, призванный помогать разработчикам, и инженерам.

Конструкторский отдел помогает осуществить:

- Регистрацию проекта у производителя компонентов.
- Техническую поддержку проекта.
- Защиту от снятия компонента с производства.
- Оценку стоимости проекта по компонентам.
- Изготовление тестовой платы монтаж и пусконаладочные работы.



Тел: +7 (812) 336 43 04 (многоканальный)

Email: org@lifeelectronics.ru