

SCR/SCR and SCR/Diode (MAGN-A-PAK Power Modules), 230 A

MAGN-A-PAK
FEATURES

- High voltage
- Electrically isolated base plate
- 3500 V_{RMS} isolating voltage
- Industrial standard package
- Simplified mechanical designs, rapid assembly
- High surge capability
- Large creepage distances
- UL approved file E78996
- Designed and qualified for industrial level
- Material categorization: for definitions of compliance please see www.vishay.com/doc?99912

**RoHS
COMPLIANT**
PRIMARY CHARACTERISTICS

$I_{T(AV)}$	230 A
Type	Modules - thyristor, standard
Package	MAGN-A-PAK

DESCRIPTION

This VSK series of MAGN-A-PAK modules uses high voltage power thyristor/thyristor and thyristor/diode in seven basic configurations. The semiconductors are electrically isolated from the metal base, allowing common heatsinks and compact assemblies to be built. They can be interconnected to form single phase or three phase bridges or as AC-switches when modules are connected in anti-parallel mode. These modules are intended for general purpose applications such as battery chargers, welders, motor drives, UPS, etc.

MAJOR RATINGS AND CHARACTERISTICS

SYMBOL	CHARACTERISTICS	VALUES	UNITS
$I_{T(AV)}$	85 °C	230	A
$I_{T(RMS)}$		510	
I_{TSM}	50 Hz	7500	
	60 Hz	7850	
I^2t	50 Hz	280	kA ² s
	60 Hz	260	
$I^2\sqrt{t}$		280	kA ² √s
V_{DRM}/V_{RRM}		800 to 2000	V
T_J	Range	-40 to +130	°C

ELECTRICAL SPECIFICATIONS
VOLTAGE RATINGS

TYPE NUMBER	VOLTAGE CODE	V_{RRM}/V_{DRM} , MAXIMUM REPETITIVE PEAK REVERSE AND OFF-STATE BLOCKING VOLTAGE V	V_{RSM} , MAXIMUM NON-REPETITIVE PEAK REVERSE VOLTAGE V	I_{RRM}/I_{DRM} AT 130 °C MAXIMUM mA
VS-VSK.230-	08	800	900	50
	12	1200	1300	
	16	1600	1700	
	18	1800	1900	
	20	2000	2100	



ON-STATE CONDUCTION					
PARAMETER	SYMBOL	TEST CONDITIONS		VALUES	UNITS
Maximum average on-state current at case temperature	$I_{T(AV)}$	180° conduction, half sine wave		230	A
				85	°C
Maximum RMS on-state current	$I_{T(RMS)}$	As AC switch		510	
Maximum peak, one-cycle on-state non-repetitive, surge current	I_{TSM}	t = 10 ms	No voltage reapplied	7500	A
		t = 8.3 ms		7850	
		t = 10 ms	100 % V_{RRM} reapplied	6300	
		t = 8.3 ms		6600	
Maximum I^2t for fusing	I^2t	t = 10 ms	No voltage reapplied	280	kA ² s
		t = 8.3 ms		256	
		t = 10 ms	100 % V_{RRM} reapplied	198	
		t = 8.3 ms		181	
Maximum $I^2\sqrt{t}$ for fusing	$I^2\sqrt{t}$	t = 0.1 ms to 10 ms, no voltage reapplied		2800	kA ² /s
Low level value or threshold voltage	$V_{T(TO)1}$	$(16.7\% \times \pi \times I_{T(AV)} < I < \pi \times I_{T(AV)})$, $T_J = T_J$ maximum		1.03	V
High level value of threshold voltage	$V_{T(TO)2}$	$(I > \pi \times I_{T(AV)})$, $T_J = T_J$ maximum		1.07	
Low level value on-state slope resistance	r_{t1}	$(16.7\% \times \pi \times I_{T(AV)} < I < \pi \times I_{T(AV)})$, $T_J = T_J$ maximum		0.77	mΩ
High level value on-state slope resistance	r_{t2}	$(I > \pi \times I_{T(AV)})$, $T_J = T_J$ maximum		0.73	
Maximum on-state voltage drop	V_{TM}	$I_{TM} = \pi \times I_{T(AV)}$, $T_J = T_J$ maximum, 180° conduction, average power = $V_{T(TO)} \times I_{T(AV)} + r_f \times (I_{T(RMS)})^2$		1.59	V
Maximum holding current	I_H	Anode supply = 12 V, initial $I_T = 30$ A, $T_J = 25$ °C		500	
Maximum latching current	I_L	Anode supply = 12 V, resistive load = 1 Ω, gate pulse: 10 V, 100 μs, $T_J = 25$ °C		1000	mA

SWITCHING					
PARAMETER	SYMBOL	TEST CONDITIONS		VALUES	UNITS
Typical delay time	t_d	$T_J = 25$ °C, gate current = 1 A $dI_g/dt = 1$ A/μs, $V_d = 0.67\% V_{DRM}$		1.0	μs
Typical rise time	t_r			2.0	
Typical turn-off time	t_q	$I_{TM} = 300$ A; $dI/dt = 15$ A/μs; $T_J = T_J$ maximum; $V_R = 50$ V; $dV/dt = 20$ V/μs; gate 0 V, 100 Ω		50 to 150	

BLOCKING					
PARAMETER	SYMBOL	TEST CONDITIONS		VALUES	UNITS
Maximum peak reverse and off-state leakage current	I_{RRM} , I_{DRM}	$T_J = T_J$ maximum		50	mA
RMS insulation voltage	V_{INS}	50 Hz, circuit to base, all terminals shorted, 25 °C, 1 s		3000	V
Critical rate of rise of off-state voltage	dV/dt	$T_J = T_J$ maximum, exponential to 67 % rated V_{DRM}		1000	V/μs

TRIGGERING					
PARAMETER	SYMBOL	TEST CONDITIONS		VALUES	UNITS
Maximum peak gate power	P_{GM}	$t_p \leq 5$ ms, $T_J = T_J$ maximum		10.0	W
Maximum average gate power	$P_{G(AV)}$	f = 50 Hz, $T_J = T_J$ maximum		2.0	
Maximum peak gate current	+ I_{GM}	$t_p \leq 5$ ms, $T_J = T_J$ maximum		3.0	A
Maximum peak negative gate voltage	- V_{GT}	$t_p \leq 5$ ms, $T_J = T_J$ maximum		5.0	
Maximum required DC gate voltage to trigger	V_{GT}	$T_J = -40$ °C	Anode supply = 12 V, resistive load; $R_a = 1$ Ω	4.0	V
		$T_J = 25$ °C		3.0	
		$T_J = T_J$ maximum		2.0	
Maximum required DC gate current to trigger	I_{GT}	$T_J = -40$ °C	Anode supply = 12 V, resistive load; $R_a = 1$ Ω	350	mA
		$T_J = 25$ °C		200	
		$T_J = T_J$ maximum		100	
Maximum gate voltage that will not trigger	V_{GD}	$T_J = T_J$ maximum, rated V_{DRM} applied		0.25	V
Maximum gate current that will not trigger	I_{GD}	$T_J = T_J$ maximum, rated V_{DRM} applied		10.0	mA
Maximum rate of rise of turned-on current	dI/dt	$T_J = T_J$ maximum, $I_{TM} = 400$ A, rated V_{DRM} applied		500	A/μs



THERMAL AND MECHANICAL SPECIFICATIONS				
PARAMETER	SYMBOL	TEST CONDITIONS	VALUES	UNITS
Junction operating temperature range	T_J		-40 to +130	°C
Storage temperature range	T_{Stg}		-40 to +150	
Maximum thermal resistance, junction to case per junction	R_{thJC}	DC operation	0.125	K/W
Typical thermal resistance, case to heatsink per module	R_{thCS}	Mounting surface flat, smooth, and greased	0.02	
Mounting torque $\pm 10\%$	MAGN-A-PAK to heatsink busbar to MAGN-A-PAK	A mounting compound is recommended and the torque should be rechecked after a period of about 3 h to allow for the spread of the compound.	4 to 6	Nm
Approximate weight				
			17.8	oz.
Case style			MAGN-A-PAK	

ΔR CONDUCTION PER JUNCTION											
DEVICES	SINUSOIDAL CONDUCTION AT T_J MAXIMUM					RECTANGULAR CONDUCTION AT T_J MAXIMUM					UNITS
	180°	120°	90°	60°	30°	180°	120°	90°	60°	30°	
VSK.230-	0.009	0.010	0.010	0.020	0.032	0.007	0.011	0.015	0.020	0.033	K/W

Note

- Table shows the increment of thermal resistance R_{thJC} when devices operate at different conduction angles than DC



Fig. 1 - Current Ratings Characteristics



Fig. 2 - Current Ratings Characteristics



Fig. 3 - On-State Power Loss Characteristics

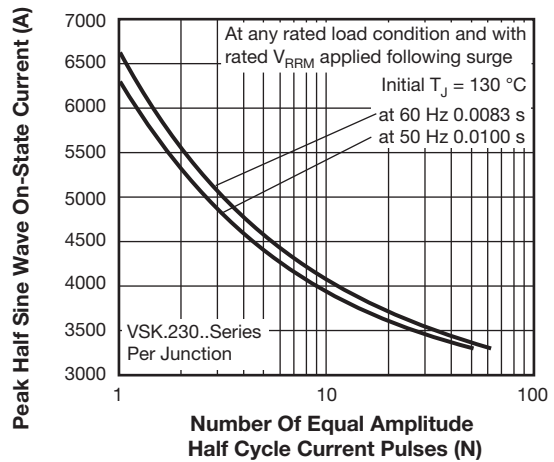

Fig. 5 - Maximum Non-Repetitive Surge Current



Fig. 4 - On-State Power Loss Characteristics

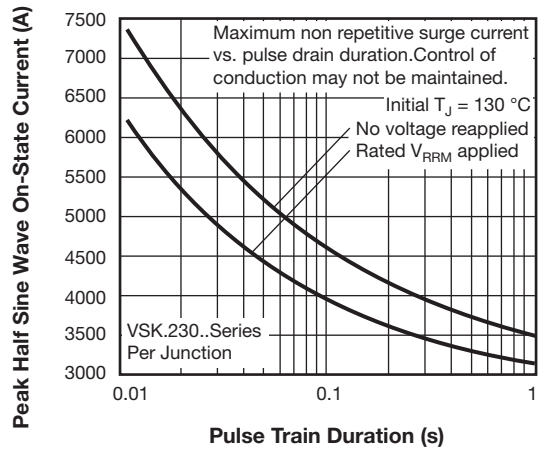

Fig. 6 - Maximum Non-Repetitive Surge Current



Fig. 7 - On-State Power Loss Characteristics

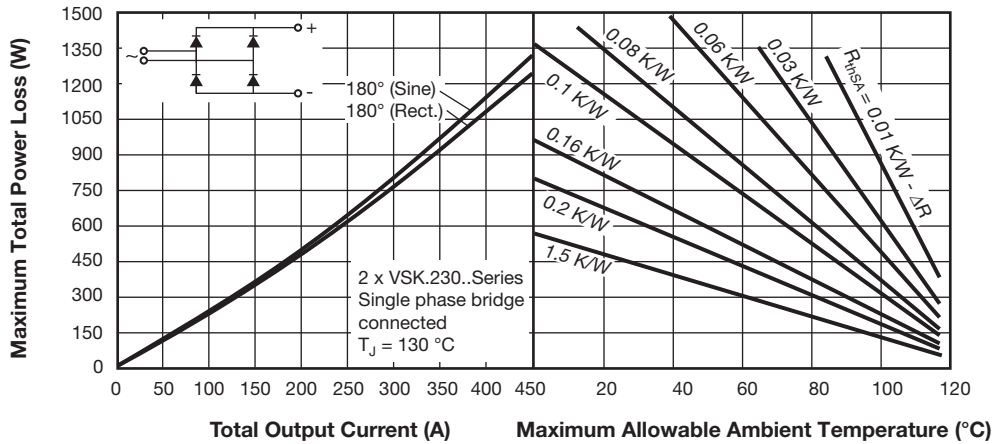

Fig. 8 - On-State Power Loss Characteristics

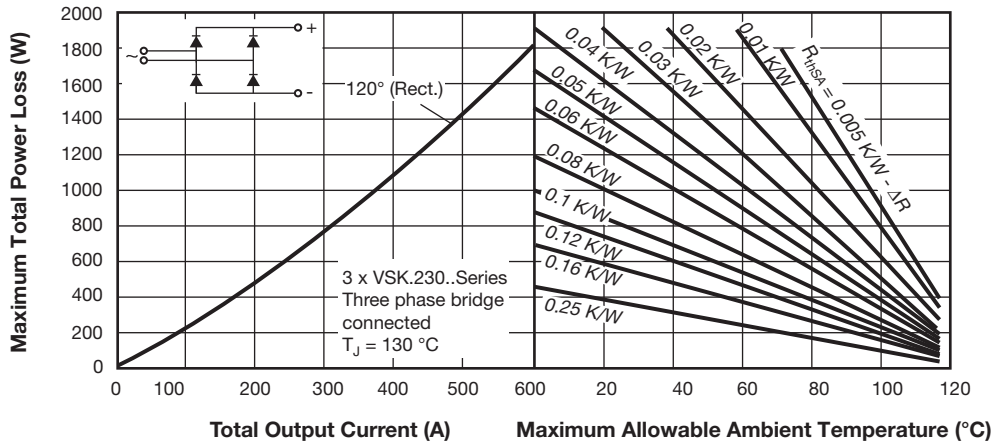

Fig. 9 - On-State Power Loss Characteristics

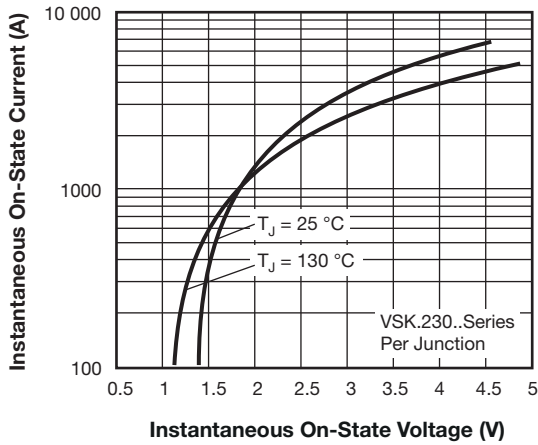

Fig. 10 - On-State Voltage Drop Characteristics

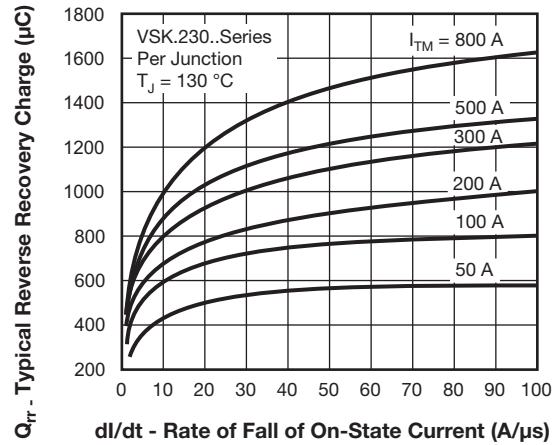

Fig. 11 - Reverse Recovery Charge Characteristics

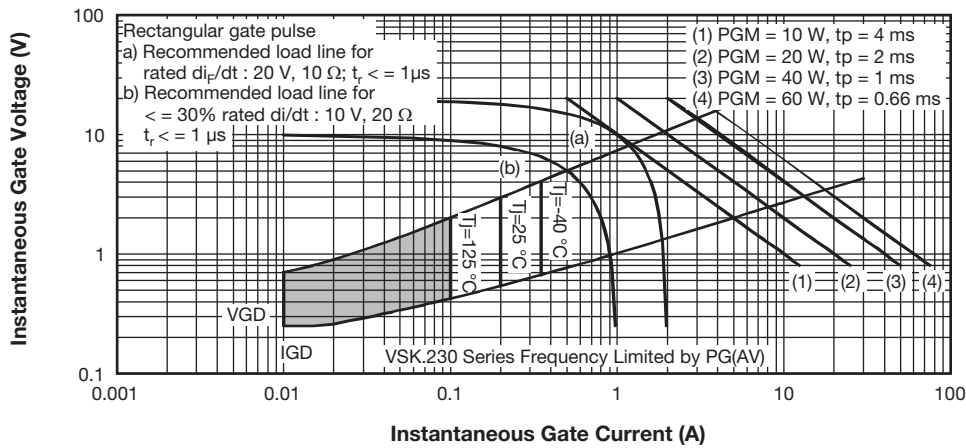

Fig. 12 - Gate Characteristics



Fig. 13 - Thermal Impedance Z_{thJC} Characteristics

ORDERING INFORMATION TABLE

Device code	VS-VS	KT	230	-	20	PbF
	①	②	③	④	⑤	

- 1** - Vishay Semiconductors product
- 2** - Circuit configuration (see dimensions - link at the end of datasheet)
- 3** - Current rating
- 4** - Voltage code x 100 = V_{RRM} (see Voltage Ratings table)
- 5** -
 - None = standard production
 - PbF = lead (Pb)-free

Note

- To order the optional hardware go to www.vishay.com/doc?95172



CIRCUIT CONFIGURATION		
CIRCUIT DESCRIPTION	CIRCUIT CONFIGURATION CODE	CIRCUIT DRAWING
Two SCRs doubler circuit	KT	<p>VSKT...</p> <p>Available 800 V: contact factory for different requirements</p>
SCR/diode doubler circuit, positive control	KH	<p>VSKH...</p> <p>Available 800 V: contact factory for different requirements</p>
SCR/diode doubler circuit, negative control	KL	<p>VSKL...</p> <p>Available 800 V: contact factory for different requirements</p>
Two SCRs common cathodes	KK	<p>VSKK...</p> <p>Available 800 V: contact factory for different requirements</p>

LINKS TO RELATED DOCUMENTS	
Dimensions	www.vishay.com/doc?95086

MAGN-A-PAK

DIMENSIONS in millimeters (inches)



Notes

- Dimensions are nominal
- Full engineering drawings are available on request
- UL identification number for gate and cathode wire: UL 1385
- UL identification number for package: UL 94 V-0



Disclaimer

ALL PRODUCT, PRODUCT SPECIFICATIONS AND DATA ARE SUBJECT TO CHANGE WITHOUT NOTICE TO IMPROVE RELIABILITY, FUNCTION OR DESIGN OR OTHERWISE.

Vishay Intertechnology, Inc., its affiliates, agents, and employees, and all persons acting on its or their behalf (collectively, "Vishay"), disclaim any and all liability for any errors, inaccuracies or incompleteness contained in any datasheet or in any other disclosure relating to any product.

Vishay makes no warranty, representation or guarantee regarding the suitability of the products for any particular purpose or the continuing production of any product. To the maximum extent permitted by applicable law, Vishay disclaims (i) any and all liability arising out of the application or use of any product, (ii) any and all liability, including without limitation special, consequential or incidental damages, and (iii) any and all implied warranties, including warranties of fitness for particular purpose, non-infringement and merchantability.

Statements regarding the suitability of products for certain types of applications are based on Vishay's knowledge of typical requirements that are often placed on Vishay products in generic applications. Such statements are not binding statements about the suitability of products for a particular application. It is the customer's responsibility to validate that a particular product with the properties described in the product specification is suitable for use in a particular application. Parameters provided in datasheets and / or specifications may vary in different applications and performance may vary over time. All operating parameters, including typical parameters, must be validated for each customer application by the customer's technical experts. Product specifications do not expand or otherwise modify Vishay's terms and conditions of purchase, including but not limited to the warranty expressed therein.

Except as expressly indicated in writing, Vishay products are not designed for use in medical, life-saving, or life-sustaining applications or for any other application in which the failure of the Vishay product could result in personal injury or death. Customers using or selling Vishay products not expressly indicated for use in such applications do so at their own risk. Please contact authorized Vishay personnel to obtain written terms and conditions regarding products designed for such applications.

No license, express or implied, by estoppel or otherwise, to any intellectual property rights is granted by this document or by any conduct of Vishay. Product names and markings noted herein may be trademarks of their respective owners.

Компания «Life Electronics» занимается поставками электронных компонентов импортного и отечественного производства от производителей и со складов крупных дистрибьюторов Европы, Америки и Азии.

С конца 2013 года компания активно расширяет линейку поставок компонентов по направлению коаксиальный кабель, кварцевые генераторы и конденсаторы (керамические, пленочные, электролитические), за счёт заключения дистрибьюторских договоров

Мы предлагаем:

- Конкурентоспособные цены и скидки постоянным клиентам.
- Специальные условия для постоянных клиентов.
- Подбор аналогов.
- Поставку компонентов в любых объемах, удовлетворяющих вашим потребностям.
- Приемлемые сроки поставки, возможна ускоренная поставка.
- Доставку товара в любую точку России и стран СНГ.
- Комплексную поставку.
- Работу по проектам и поставку образцов.
- Формирование склада под заказчика.
- Сертификаты соответствия на поставляемую продукцию (по желанию клиента).
- Тестирование поставляемой продукции.
- Поставку компонентов, требующих военную и космическую приемку.
- Входной контроль качества.
- Наличие сертификата ISO.

В составе нашей компании организован Конструкторский отдел, призванный помогать разработчикам, и инженерам.

Конструкторский отдел помогает осуществить:

- Регистрацию проекта у производителя компонентов.
- Техническую поддержку проекта.
- Защиту от снятия компонента с производства.
- Оценку стоимости проекта по компонентам.
- Изготовление тестовой платы монтаж и пусконаладочные работы.



Тел: +7 (812) 336 43 04 (многоканальный)

Email: org@lifeelectronics.ru