

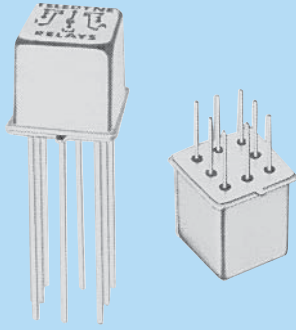

A Unit of Teledyne Electronics and Communications

CENTIGRID® ESTABLISHED RELIABILITY RELAYS SENSITIVE DPDT

SERIES 134



ESTABLISHED RELIABILITY

SERIES DESIGNATION	RELAY TYPE
134	DPDT basic relay
134D	DPDT relay with internal diode for coil transient suppression
134DD	DPDT relay with internal diodes for coil transient suppression and polarity reversal protection

INTERNAL CONSTRUCTION

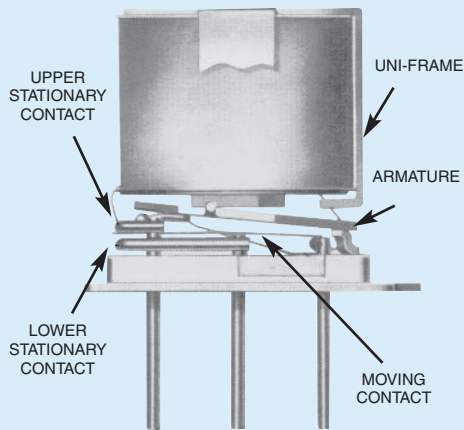

DESCRIPTION

The 134 sensitive Centigrad® relay retains the same features as the 114 standard Centigrad® relay with only a minimal increase in profile height (.375 in.). Its .100-inch grid spaced terminals, which preclude the need for spreader pads, and its low profile make the 134 relay ideal for applications where high packaging density is important.

The following unique construction features and manufacturing techniques provide excellent resistance to environmental extremes and overall high reliability:

- All welded construction.
- Unique uni-frame design providing high magnetic efficiency and mechanical rigidity.
- High force/mass ratios for resistance to shock and vibration.
- Advanced cleaning techniques provide maximum assurance of internal cleanliness.
- Precious metal alloy contact material with gold plating assures excellent high current and dry circuit switching capabilities.

The Series 134D and 134DD have internal discrete silicon diodes for coil suppression and polarity reversal protection.

The sensitive 134 Centigrad® relay has a high resistance coil, thus requiring extremely low operating power (200 mw typical). The advantages of reduced heat dissipation and power supply demands are a plus.

By virtue of its inherently low intercontact capacitance and contact circuit losses, the 134 relay has proven to be an excellent ultraminiature RF switch for frequency ranges well into the UHF spectrum. A typical RF application for the Centigrad® relay is in handheld radio transceivers, wherein the combined features of good RF performance, small size, low coil power dissipation and high reliability make it a preferred method of Transmit-Receive switching (see Figure 1).

ENVIRONMENTAL AND PHYSICAL SPECIFICATIONS

Temperature (Ambient)	-65°C to +125°C
Vibration (General Note 1)	30 g's to 3000 Hz
Shock (General Note 1)	75 g's, 6 msec, half-sine
Acceleration	50 g's
Enclosure	Hermetically sealed
Weight	0.15 oz. (4.3g) max.

SERIES 134
GENERAL ELECTRICAL SPECIFICATIONS (-65°C to +125°C unless otherwise noted) (Notes 2 & 3)

Contact Arrangement	2 Form C (DPDT)	
Rated Duty	Continuous	
Contact Resistance	0.1 ohm max. before life; 0.2 ohm max. after life at 1A/28Vdc (measured 1/8" from header)	
Contact Load Ratings (DC) (See Fig. 2 for other DC resistive voltage/current ratings)	Resistive: 1 Amp/28Vdc Inductive: 200 mA/28Vdc (320 mH) Lamp: 100 mA/28Vdc Low Level: 10 to 50 μ A/10 to 50mV	
Contact Load Ratings (AC)	Resistive: 250 mA/115Vac, 60 and 400 Hz (Case not grounded) 100 mA/115Vac, 60 and 400 Hz (Case grounded)	
Contact Life Ratings	10,000,000 cycles (typical) at low level 1,000,000 cycles (typical) at 0.5A/28Vdc resistive 100,000 cycles min. at all other loads specified above	
Contact Overload Rating	2A/28Vdc Resistive (100 cycles min.)	
Contact Carry Rating	Contact factory	
Coil Operating Power	200 milliwatts typical at nominal rated voltage @ 25°C	
Operate Time	4.0 msec max. at nominal rated coil voltage	
Release Time	134 Series: 2.0 msec max. 134D, 134DD Series: 7.5 msec max.	
Contact Bounce	1.5 msec max.	
Intercontact Capacitance	0.4 pf typical	
Insulation Resistance	10,000 megohms min. between mutually isolated terminals	
Dielectric Strength	Atmospheric pressure: 500 Vrms/60Hz	70,000 ft.: 125 Vrms/60Hz
Negative Coil Transient (Vdc)	134D, 134DD	1.0 max
Diode P.I.V. (Vdc)	134D, 134DD	100 min.

DETAILED ELECTRICAL SPECIFICATIONS (-65°C to +125°C unless otherwise noted) (Note 3)

	BASE PART NUMBERS (See Note 8 for full P/N example)	➔	134-5	134-6	134-9	134-12	134-18	134-26
			134D-5 134DD-5	134D-6 134DD-6	134D-9 134DD-9	134D-12 134DD-12	134D-18 134DD-18	134D-26 134DD-26
Coil Voltage (Vdc)	Nom.		5.0	6.0	9.0	12.0	18.0	26.5
	Max.		7.5	10.0	15.0	20.0	30.0	40.0
Coil Resistance (Ohms \pm10% @25°C)	134, 134D		100	200	400	800	1600	3200
	134DD (Note 4)		64	125	400	800	1600	3200
Coil Current (mA_{dc} @25°C) (134DD Series)	Min.		56.8	36.3	18.1	12.5	9.6	7.2
	Max.		78.1	48.9	23.6	16.0	12.2	9.0
Pick-up Voltage (Vdc, Max.)	134, 134D		3.5	4.5	6.8	9.0	13.5	18.0
	134DD		3.7	4.8	8.0	11.0	14.5	19.0
Drop-out Voltage (Vdc)	134, 134D	Min.	0.12	0.18	0.35	0.41	0.59	0.89
		Max.	2.5	3.2	4.9	6.5	10.0	13.0
	134DD	Min.	0.7	0.8	0.9	1.0	1.1	1.3
		Max.	2.6	3.0	4.5	5.8	9.0	13.0

PERFORMANCE CURVES
(NOTE 2)

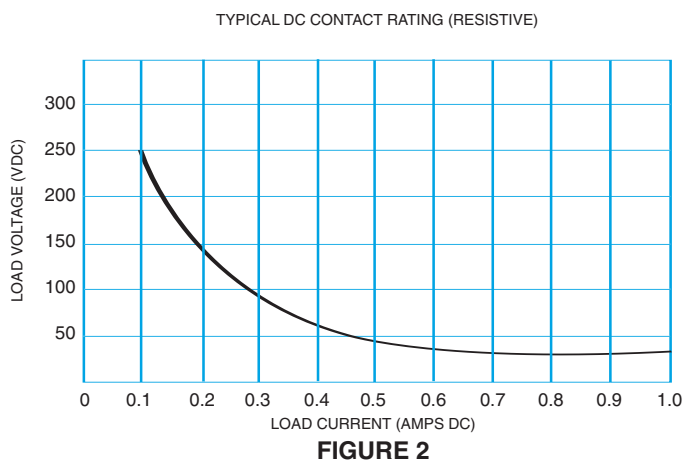
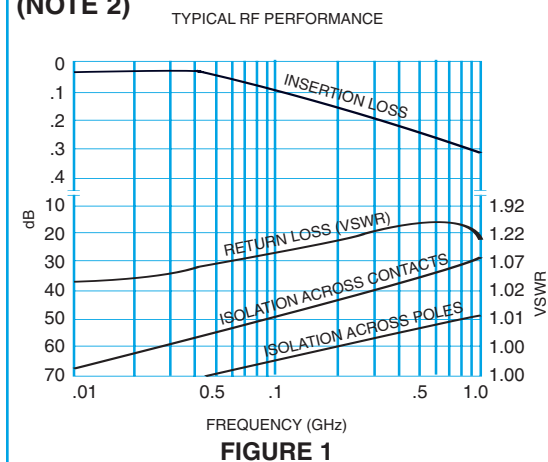

SERIES 134



GENERAL NOTES

1. Relay contacts will exhibit no chatter in excess of 10 μsec or transfer in excess of 1 μsec.
2. "Typical" characteristics are based on available data and are best estimates. No on-going verification tests are performed.
3. Unless otherwise specified, parameters are initial values.
4. For reference only. Coil resistance not directly measurable at relay terminals due to internal series diode in 134DD only.
5. Unless otherwise specified, relays will be supplied with either gold-plated or solder-coated leads.
6. The slash and characters appearing after the slash are not marked on the relay.
7. Screened HI-REL versions available. Contact factory.
- 8.

ESTABLISHED RELIABILITY

Teledyne Part Numbering System for T²R[®] Established Reliability Relay



Teledyne Part Numbering System for Military Qualified (JAN) Relays

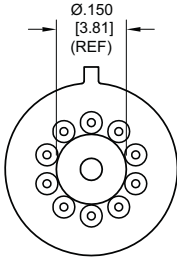
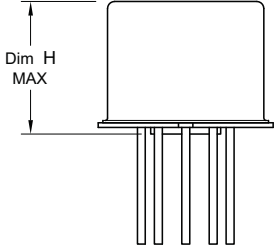
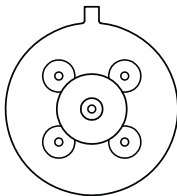
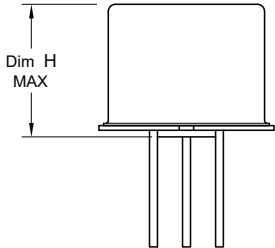
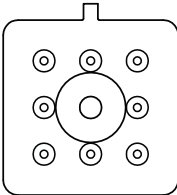
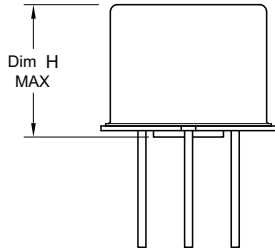
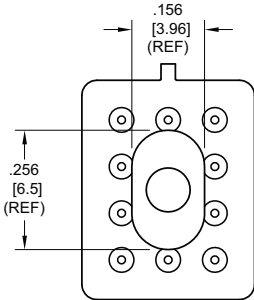
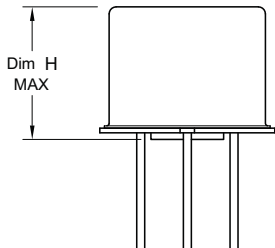

Appendix A: Spacer Pads

Pad designation and bottom view dimensions	Height	For use with the following:	Dim. H Max.
 <p style="text-align: center;">“M4” Pad for TO-5</p>		ER411T ER412, ER412D, ER412DD	.295 (7.49)
		712, 712D, 712TN, RF300, RF310, RF320	.300 (7.62)
		ER420, ER422D, ER420DD, 421, ER421D, ER421DD, ER422, ER422D, ER422DD, 722, 722D, RF341	.305 (7.75)
		ER431T, ER432T, ER432, ER432D, ER432DD	.400 (10.16)
		732, 732D, 732TN, RF303, RF313, RF323	.410 (10.41)
		RF312	.350 (8.89)
 <p style="text-align: center;">“M4” Pad for TO-5</p>		ER411, ER411D, ER411DD	.295 (7.49)
		ER431, ER431D, ER431DD	.400 (10.16)
		RF311	.300 (7.62)
		RF331	.410 (10.41)
 <p style="text-align: center;">“M4” Pad for Centigrid®</p>		172, 172D	.305 (7.75)
		ER114, ER114D, ER114DD, J114, J114D, J114DD	.300 (7.62)
		ER134, ER134D, ER134DD, J134, J134D, J134DD	.400 (10.16)
		RF100	.315 (8.00)
		RF103	.420 (10.67)
 <p style="text-align: center;">“M9” Pad for Centigrid®</p>		122C, A152	.320 (8.13)
		ER116C, J116C	.300 (7.62)
		ER136C, J136C	.400 (10.16)
		RF180	.325 (8.25)
		A150	.305 (7.75)

Notes:

1. Spacer pad material: Polyester film.
2. To specify an “M4” or “M9” spacer pad, refer to the mounting variants portion of the part numbering example in the applicable datasheet.
3. Dimensions are in inches (mm).
4. Unless otherwise specified, tolerance is $\pm .010$ (.25).
5. Add 10 m Ω to the contact resistance show in the datasheet.
6. Add 0.01 oz. (0.25 g) to the weight of the relay assembly shown in the datasheet.

Appendix A: Spreader Pads

Pad designation and bottom view dimensions	Height	For use with the following:	Dim. H Max.
<p>"M" Pad <u>5/</u> <u>6/</u></p>		ER411T, J411T, ER412, ER412D ER412DD, J412, J412D, J412DD ER412T, J412T	.388 (9.86)
		712, 712D, 712TN	.393 (9.99)
		ER431T, J431T, ER432, ER432D ER432DD, J432, J432D, J432DD ER432T, J432T	.493 (12.52)
		732, 732D, 732TN	.503 (12.78)
		ER420, J420, ER420D, J420D ER420DD, J420DD, ER421, J421 ER421D, J421D, ER421DD J422D, ER422DD, J422DD, 722	.398 (10.11)
<p>"M2" Pad <u>7/</u> <u>8/</u></p>		ER411T ER412, ER412D, ER412DD J412, J412D, J412DD	.441 (11.20)
		712, 712D	.451 (11.46)
		ER421, ER421D, ER421DD 722, 732D	.451 (11.46)
		ER431T ER432, ER432D, ER432DD	.546 (13.87)
		732, 732D	.556 (14.12)
<p>"M3" Pad <u>5/</u> <u>6/</u> <u>9/</u></p>		ER411, ER411D, ER411DD ER411TX ER412X, ER412DX, ER412DDX ER412TX	.388 (9.86)
		712X, 712DX, 712TNX	.393 (9.99)
		ER420X, ER420DX, ER420DDX ER421X, ER421DX, ER421DDX ER422X, ER422DX ER422DDX, 722X, 722DDX	.398 (10.11)
		ER431, ER431D, ER431DD ER431TX ER432X, ER432DX, ER432DDX ER432TX	.493 (12.52)
		732X, 732DX, 732TNX	.503 (12.78)

Notes:

1. Spreader pad material: Diallyl Phthalate.
2. To specify an "M", "M2" or "M3" spreader pad, refer to the mounting variants portion of the part number example in the applicable datasheet.
3. Dimensions are in inches (mm).
4. Unless otherwise specified, tolerance is $\pm .010$ " (0.25).
- 5/. Add 25 m Ω to the contact resistance shown in the datasheet.
- 6/. Add .01 oz. (0.25 g) to the weight of the relay assembly shown in the datasheet.
- 7/. Add 50 m Ω to the contact resistance shown in the datasheet.
- 8/. Add 0.025 oz (0.71 g) to the weight of the relay assembly shown in the datasheet.
- 9/. M3 pad to be used only when the relay has a center pin (e.g. ER411M3-12A, 722XM3-26.)

Appendix A: Ground Pin Positions



TO-5 Relays:

ER411T, ER412, ER412T, ER420, ER421, ER422,
ER431T, ER432, ER432T, 712, 712TN, 400H, 400K,
400V, RF300, RF303, RF341, RF312, RF310, RF313,
RF320, RF323



TO-5 Relays:

ER411, ER431, RF311, RF331



Centigrid® Relays:

RF180, ER116C, 122C, ER136C



Centigrid® Relays:

RF100, RF103, ER114, ER134, 172

- Indicates ground pin position
- Indicates glass insulated lead position
- ◎ Indicates ground pin or lead position depending on relay type

NOTES

1. Terminal views shown
2. Dimensions are in inches (mm)
3. Tolerances: $\pm .010$ ($\pm .25$) unless otherwise specified
4. Ground pin positions are within $.015$ (0.38) dia. of true position
5. Ground pin head dia., 0.035 (0.89) ref: height 0.010 (0.25) ref.
6. Lead dia. 0.017 (0.43) nom.

Компания «Life Electronics» занимается поставками электронных компонентов импортного и отечественного производства от производителей и со складов крупных дистрибьюторов Европы, Америки и Азии.

С конца 2013 года компания активно расширяет линейку поставок компонентов по направлению коаксиальный кабель, кварцевые генераторы и конденсаторы (керамические, пленочные, электролитические), за счёт заключения дистрибьюторских договоров

Мы предлагаем:

- Конкурентоспособные цены и скидки постоянным клиентам.
- Специальные условия для постоянных клиентов.
- Подбор аналогов.
- Поставку компонентов в любых объемах, удовлетворяющих вашим потребностям.
- Приемлемые сроки поставки, возможна ускоренная поставка.
- Доставку товара в любую точку России и стран СНГ.
- Комплексную поставку.
- Работу по проектам и поставку образцов.
- Формирование склада под заказчика.
- Сертификаты соответствия на поставляемую продукцию (по желанию клиента).
- Тестирование поставляемой продукции.
- Поставку компонентов, требующих военную и космическую приемку.
- Входной контроль качества.
- Наличие сертификата ISO.

В составе нашей компании организован Конструкторский отдел, призванный помогать разработчикам, и инженерам.

Конструкторский отдел помогает осуществить:

- Регистрацию проекта у производителя компонентов.
- Техническую поддержку проекта.
- Защиту от снятия компонента с производства.
- Оценку стоимости проекта по компонентам.
- Изготовление тестовой платы монтаж и пусконаладочные работы.



Тел: +7 (812) 336 43 04 (многоканальный)

Email: org@lifeelectronics.ru