



FCIconnect.com

Copyright FCI.

List of "SFW\_\_R-1/2STE1LF" customer document

DOCUMENT NO.	LIST
SC-SFW10	SPEC.
JSA95854	CAT.NO.TABLE FOR 1mm SPACING SMT CONNECTOR (SFW__R-1/2ST__LF)
JSA95855	1mm SPACING SMT CONNECTOR (SFW__R-1ST__LF)
JSA95856	1mm SPACING SMT CONNECTOR (SFW__R-2ST__LF)
JSA95857	CAT.NO.TABLE FOR PLASTIC TAPE PACKAGED 1mm SPACING SMT CONNECTOR (SFW__R-1/2STE1LF)
JSA95858	PLASTIC TAPE PACKAGED 1mm SPACING SMT CONNECTOR (SFW__R-1STE1LF)
JSA95859	PLASTIC TAPE PACKAGED 1mm SPACING SMT CONNECTOR (SFW__R-2STE1LF)
JSA91605	RECOMMENDED CABLE (FPC) (SFW__R-1/2ST__)
JSA91604	RECOMMENDED CABLE (FFC) (SFW__R-1/2ST__)
GS-20-129	HANDLING PROCEDURES

mat'l. code -				surface ISO 1302 <input checked="" type="checkbox"/> 58 / tolerance ISO 406 / ISO 1101		projection		product family 58RF		CODE JP	
ltr ecn no dr date				tolerances unless otherwise specified		mm		title			
A J05-0055 H.T '05/2/4				angles linear		scale X		1mm SPACING FPC/FFC CONNECTOR DOCUMENT LIST			
B J06-0398 H.T 9/26/'06								(Cat. No. : SFW__R-1/2STE1LF)			
C J09-0358 M.Y 2009-10-5								dwg no		sheet 1 of 1 size	
D J09-0380 M.Y 2009-10-27				dr M. YAMASHITA 2009-10-27				JSA 96336		A4	
				enr M. YAMASHITA 2007-10-27				type Product Customer Drawing			
				chr S. Waki 2009-10-27							
				appd J. D. ... 2009-10-27							
sheet index		revision sheet		D 1						Rev. D	



CAT. NO. & DIMENSIONS

NO. OF CONTACTS (n)	CAT. NO.	DIMENSIONS (NOTE2)			
		A ± 0.2	B ± 0.2	C ± 0.2	D ± 0.1
4	SFW4R-1/2ST__LF	9.8	8.6	3.0	5.3
5	SFW5R-1/2ST__LF	10.8	9.6	4.0	6.3
6	SFW6R-1/2ST__LF	11.8	10.6	5.0	7.3
7	SFW7R-1/2ST__LF	12.8	11.6	6.0	8.3
8	SFW8R-1/2ST__LF	13.8	12.6	7.0	9.3
9	SFW9R-1/2ST__LF	14.8	13.6	8.0	10.3
10	SFW10R-1/2ST__LF	15.8	14.6	9.0	11.3
11	SFW11R-1/2ST__LF	16.8	15.6	10.0	12.3
12	SFW12R-1/2ST__LF	17.8	16.6	11.0	13.3
13	SFW13R-1/2ST__LF	18.8	17.6	12.0	14.3
14	SFW14R-1/2ST__LF	19.8	18.6	13.0	15.3
15	SFW15R-1/2ST__LF	20.8	19.6	14.0	16.3
16	SFW16R-1/2ST__LF	21.8	20.6	15.0	17.3
17	SFW17R-1/2ST__LF	22.8	21.6	16.0	18.3
18	SFW18R-1/2ST__LF	23.8	22.6	17.0	19.3
19	SFW19R-1/2ST__LF	24.8	23.6	18.0	20.3
20	SFW20R-1/2ST__LF	25.8	24.6	19.0	21.3
21	SFW21R-1/2ST__LF	26.8	25.6	20.0	22.3
22	SFW22R-1/2ST__LF	27.8	26.6	21.0	23.3
23	SFW23R-1/2ST__LF	28.8	27.6	22.0	24.3
24	SFW24R-1/2ST__LF	29.8	28.6	23.0	25.3
25	SFW25R-1/2ST__LF	30.8	29.6	24.0	26.3
26	SFW26R-1/2ST__LF	31.8	30.6	25.0	27.3
27	SFW27R-1/2ST__LF	32.8	31.6	26.0	28.3
28	SFW28R-1/2ST__LF	33.8	32.6	27.0	29.3
29	SFW29R-1/2ST__LF	34.8	33.6	28.0	30.3
30	SFW30R-1/2ST__LF	35.8	34.6	29.0	31.3

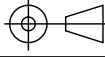
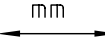

NOTES

1. THIS PRODUCT IS THE CONNECTOR USED FOR FPC/FFC AND COPE WITH AUTOMATIC MOUNTING (SMT).
2. SEE PART DRAWINGS FOR DIMENSIONS A~D.
3. A  SYMBOL WILL BE NEXT TO ANY DIMENSION, VIEW, OR NOTE WHICH HAS BEEN MODIFIED WITH THE CURRENT DRAWING REVISION.

mat'l. code				surface 58 / tolerance ISO 1302 ISO 406 ISO 1101		projection 		product family 58RF		CODE JP	
ltr ecn no dr date				tolerances unless otherwise specified		mm 		title CAT. NO. TABLE FOR 1mm SPACING SMT CONNECTOR (Cat. No. SFW__R-1/2ST__LF)			
AA J05-0055 H.T 05-02-04				angles linear		scale $\times$		dwg no JSA 95854		sheet 1 of 1 size A4	
AB J06-0398 H.T 06-09-26				dr H. TAKAKURA 06-09-26				type Product Customer Drawing		Rev. AC	
AC S08-0276 DGOH 08-08-22				enr H. TAKAKURA 06-09-26							
				chr DENNIS GOH 08-08-22							
sheet index				revision AC							

This document is the property of and embodies CONFIDENTIAL and PROPRIETARY information of FCI. No part of the information shown on this document may be used in any way or disclosed to others without the written consent of FCI. Copyright FCI.



FCIconnect.com



A

B

C

D

A

B

C

D

This document is the property of and embodies CONFIDENTIAL and PROPRIETARY information of FCI. No part of the information shown on this document may be used in any way or disclosed to others without the written consent of FCI. Copyright FCI.



FCIconnect.com



PT. NO.	PARTS NAME	MATERIAL	Q'TY	NOTE
1	HOUSING	PPS RESIN GLASS REINFORCED (UL94V-0)	1	COLOR : BROWN
2	SLIDER		1	COLOR : BLACK
3	CONTACT	PHOSPHOR BRONZE	n	PLATING : TIN
4	MOUNTING PLATE		2	

n : NO. OF CONTACTS

NOTES

- THIS PRODUCT IS THE CONNECTOR USED FOR FPC/FFC AND COPES WITH AUTOMATIC MOUNTING (SMT).
- FLATNESS FOR CONTACT TERMINAL HOUSING MUST BE WITHIN TOLERANCE IN Z PORTION DETAILED DRAWING.
- THIS PRODUCT IS LOWER CONTACT TYPE CONNECTOR.
- THIS PRODUCT MEETS EUROPEAN UNION DIRECTIVES AND OTHER COUNTRY REGULATIONS AS DESCRIBED IN GS-22-008
- THE HOUSING WILL WITHSTAND EXPOSURE TO 260°C PEAK TEMPERATURE FOR 10 SECONDS IN A REFLOW SOLDERING OVEN.
- A SYMBOL WILL BE NEXT TO ANY DIMENSION, VIEW, OR NOTE WHICH HAS BEEN MODIFIED WITH THE CURRENT DRAWING REVISION.

RECOMMENDED PC BOARD LAYOUT (COMPONENT SIDE)



mat'l. code		surface 58 / tolerance ISO 1302		tolerance ISO 406 / ISO 1101		projection		product family 58RF		CODE JP	
ltr		ecn no		dr		date		title		1mm SPACING SMT CONNECTOR (Cat. No. SFW__R-1ST__LF)	
AA		J04-0180		H.T		04-07-02		mm		sheet 1 of 1	
AB		J05-0055		H.T		05-02-04		scale X		size A4	
AC		J05-0736		H.T		05-10-28		FCI		dwg no JSA 95855	
AD		J06-0398		H.T		06-09-26		type Product Customer Drawing		Rev. AE	
AE		S08-0276		DGOH		08-08-22					
sheet index		revision sheet		AE		1					

SC\_SFW10 JSA95854 form: A4

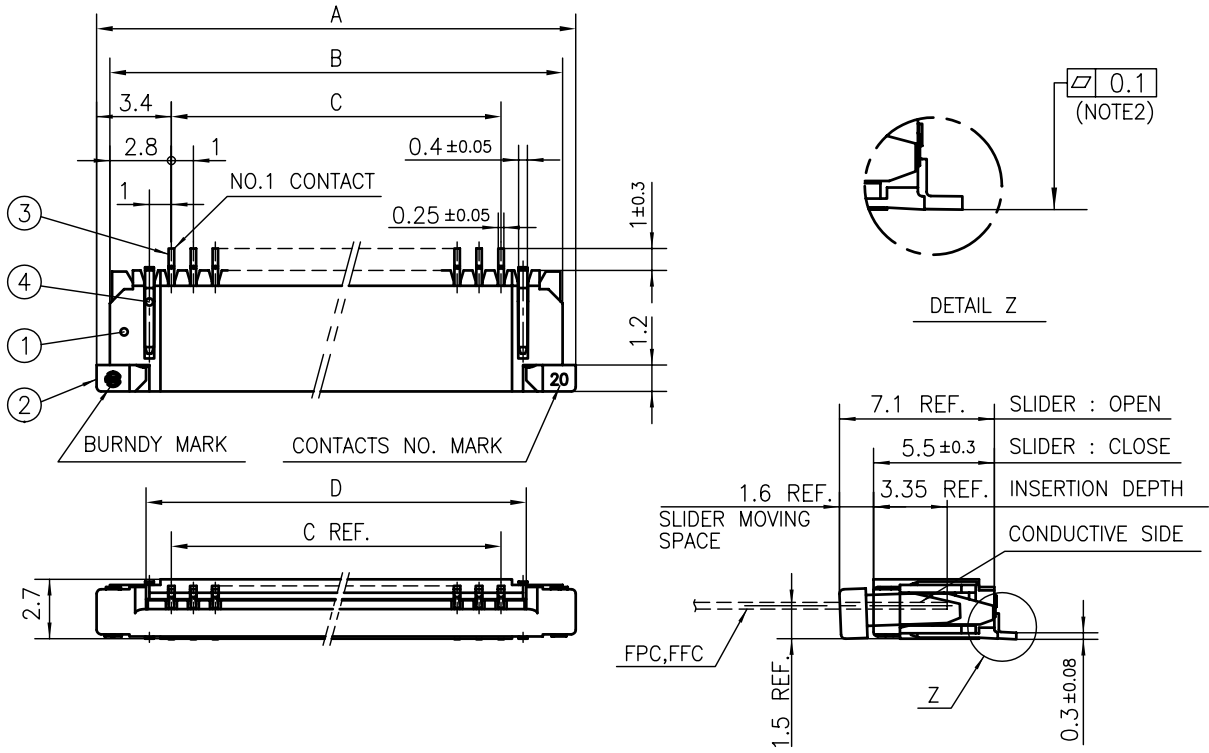

PT. NO.	PARTS NAME	MATERIAL	Q'TY	NOTE
1	HOUSING	PPS RESIN GLASS REINFORCED (UL94V-0)	1	COLOR : BROWN
2	SLIDER	PPS RESIN GLASS REINFORCED (UL94V-0)	1	COLOR : BLACK
3	CONTACT	PHOSPHOR BRONZE	n	PLATING : TIN
4	MOUNTING PLATE		2	

n : NO. OF CONTACTS

NOTES

1. THIS PRODUCT IS THE CONNECTOR USED FOR FPC/FFC AND COPEs WITH AUTOMATIC MOUNTING (SMT).
2. FLATNESS FOR CONTACT TERMINAL HOUSING MUST BE WITHIN TOLERANCE IN Z PORTION DETAILED DRAWING.
3. THIS PRODUCT IS UPPER CONTACT TYPE CONNECTOR.
4. THIS PRODUCT MEETS EUROPEAN UNION DIRECTIVES AND OTHER?COUNTRY REGULATIONS AS DESCRIBED IN GS-22-008
5. THE HOUSING WILL WITHSTAND EXPOSURE TO 260°C PEAK TEMPERATURE FOR 10 SECONDS IN A REFLOW SOLDERING OVEN.
6. A SYMBOL WILL BE NEXT TO ANY DIMENSION, VIEW, OR NOTE WHICH HAS BEEN MODIFIED WITH THE CURRENT DRAWING REVISION.

RECOMMENDED PC BOARD LAYOUT (COMPONENT SIDE)

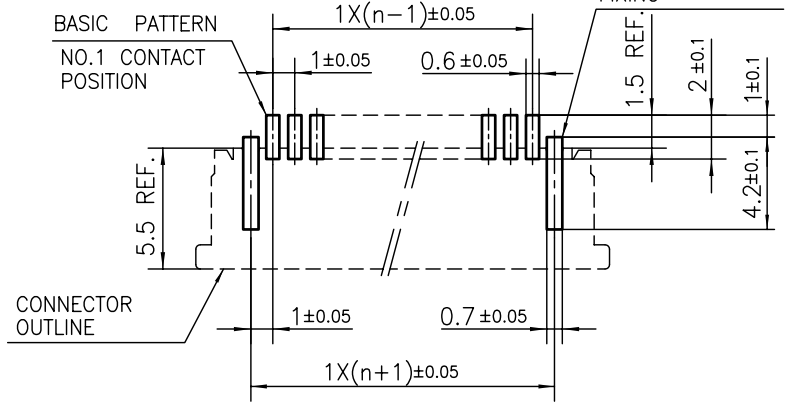

mat'l. code		surface 58 / tolerance ISO 1302 / ISO 406 / ISO 1101		projection		product family 58RF		CODE JP	
ltr ecn no dr date		tolerances unless otherwise specified ±0.2		mm		title			
AA J04-0180 H.T 04-07-02		angles linear		mm		1mm SPACING SMT CONNECTOR (Cat. No. SFW__R-2ST__LF)			
AB J05-0055 H.T 05-02-04				scale X		dwg no		sheet 1 of 1 size	
AC J05-0736 H.T 05-10-28						JSA 95856		A4	
AD J06-0398 H.T 06-09-26		dr H. TAKAKURA 06-09-26				type Product Customer Drawing			
AE S08-0276 DGOH 08-08-22		enr H. TAKAKURA 06-09-26				Rev. AE			
		chr DENNIS GOH 08-08-22							
		appd JOEY NG 08-08-22							
sheet index		revision sheet 1							

SC\_SFW10 JSA95854 form: A4

This document is the property of and embodies CONFIDENTIAL and PROPRIETARY information of FCI. No part of the information shown on this document may be used in any way or disclosed to others without the written consent of FCI. Copyright FCI.



FCIconnect.com

AE

A

B

C

D

A

B

C

D

CAT. NO. & DIMENSIONS

NO. OF CONTACTS (n)	CAT. NO. (NOTE2)	DIMENSIONS (NOTE3)		
		E ± 5	F ± 0.3	G ± 0.1
4	SFW4R-1/2STE1 LF	20.4	16	—
5	SFW5R-1/2STE1 LF	28.4	24	—
6	SFW6R-1/2STE1 LF	28.4	24	—
7	SFW7R-1/2STE1 LF	28.4	24	—
8	SFW8R-1/2STE1 LF	28.4	24	—
9	SFW9R-1/2STE1 LF	28.4	24	—
10	SFW10R-1/2STE1 LF	28.4	24	—
11	SFW11R-1/2STE1 LF	28.4	24	—
12	SFW12R-1/2STE1 LF	28.4	24	—
13	SFW13R-1/2STE1 LF	36.4	32	28.4
14	SFW14R-1/2STE1 LF	36.4	32	28.4
15	SFW15R-1/2STE1 LF	36.4	32	28.4
16	SFW16R-1/2STE1 LF	36.4	32	28.4
17	SFW17R-1/2STE1 LF	48.4	44	40.4
18	SFW18R-1/2STE1 LF	48.4	44	40.4
19	SFW19R-1/2STE1 LF	48.4	44	40.4
20	SFW20R-1/2STE1 LF	48.4	44	40.4
21	SFW21R-1/2STE1 LF	48.4	44	40.4
22	SFW22R-1/2STE1 LF	48.4	44	40.4
23	SFW23R-1/2STE1 LF	48.4	44	40.4
24	SFW24R-1/2STE1 LF	48.4	44	40.4
25	SFW25R-1/2STE1 LF	48.4	44	40.4
26	SFW26R-1/2STE1 LF	48.4	44	40.4
27	SFW27R-1/2STE1 LF	48.4	44	40.4
28	SFW28R-1/2STE1 LF	60.4	56	52.4
29	SFW29R-1/2STE1 LF	60.4	56	52.4
30	SFW30R-1/2STE1 LF	60.4	56	52.4



NOTES

1. THIS PRODUCT IS THE CONNECTOR USED FOR FPC/FFC AND COPEs WITH AUTOMATIC MOUNTING (SMT).
2. THIS CATALOG NO. INDICATES PLASTIC TAPE PACKAGED CONNECTOR.
3. SEE PART DRAWINGS FOR DIMENSIONS E~G.
4. A SYMBOL WILL BE NEXT TO ANY DIMENSION, VIEW, OR NOTE WHICH HAS BEEN MODIFIED WITH THE CURRENT DRAWING REVISION.

mat'l. code				surface 58 / tolerance ISO 1302 / ISO 406 / ISO 1101		projection		product family 58RF		CODE JP	
ltr ecn no dr date				tolerances unless otherwise specified				title			
AA J05-0055 H.T 05-02-04				angles linear		mm		CAT. NO. TABLE FOR PLASTIC TAPE PACKAGED 1mm SPACING SMT CONNECTOR (Cat. No. SFW__R-1/2STE1 LF)			
AB J06-0398 H.T 06-09-26						scale X		dwg no sheet 1 of 1 size			
AC S08-0276 DGOH 08-08-22				dr H. TAKAKURA 06-09-26				JSA 95857 A4			
				enr H. TAKAKURA 06-09-26				type Product Customer Drawing			
				chr DENNIS GOH 08-08-22							
				appd JOEY NG 08-08-22							
sheet index		revision sheet		AC 1						Rev. AC	

SC\_SFW10 JSA95854 95858 95859

form: A4

This document is the property of and embodies CONFIDENTIAL and PROPRIETARY information of FCI. No part of the information shown on this document may be used in any way or disclosed to others without the written consent of FCI. Copyright FCI.



FCIconnect.com





PT. NO.	PARTS NAME	CAT. NO.	MATERIAL	Q'TY	NOTE
1	REEL	_____	CARDBOARD	1	COLOR:WHITE/GREY
2	PLASTIC (EMBOSS) TAPE	_____	PET	_____	COLOR:TRANSPARENCY
3	COVER	_____	POLYESTER	_____	COLOR:TRANSPARENCY
4	CONNECTOR	SFW__R-1ST__LF	SEE ATTACHED DWG.	2000	LOWER CONTACT TYPE

NOTES

- THIS IS PLASTIC TAPE PACKAGED CONNECTOR USED FOR FPC/FFC AND CYPES WITH AUTOMATIC MOUNTING (SMT).
- SEE JIS C 0806 (PACKING OF ELECTRONIC COMPONENTS ON CONTINUOUS TAPES (SURFACE MOUNTING DEVICES)) FOR SHAPE AND DIMENSIONS OF PLASTIC (EMBOSS) TAPE AND REEL.
- E DIMENSION IS PORTION OF THE CORE.
- A  SYMBOL WILL BE NEXT TO ANY DIMENSION, VIEW, OR NOTE WHICH HAS BEEN MODIFIED WITH THE CURRENT DRAWING REVISION.

mat'l. code		surface 58 / tolerance ISO 1302 / ISO 406 / ISO 1101		projection 		product family 58RF		CODE JP	
ltr ecn no dr date		tolerances unless otherwise specified		mm		title			
AA J05-0055 H.T 05/02/04		angles linear ±5		mm		PLASTIC TAPE PACKAGED 1mm SPACING SMT CONNECTOR (Cat. No. SFW__R-1STE1 LF)			
AB J06-0398 H.T 06/09/26		±5'		scale $\times$		dwg no		sheet 1 of 1 size	
AC S08-0276 DGOH 08-08-22		dr H. TAKAKURA 06-09-26				JSA 95858		A4	
		enr H. TAKAKURA 06-09-26		type Product Customer Drawing					
		chr DENNIS GOH 08-08-22							
		appd JOEY NG 08-08-22							
sheet index		revision AC		Rev. AC					
1		1		2					

SC\_SFW10 JSA95857 form: A4

This document is the property of and embodies CONFIDENTIAL and PROPRIETARY information of FCI. No part of the information shown on this document may be used in any way or disclosed to others without the written consent of FCI. Copyright FCI.



FCIconnect.com

This document is the property of and embodies CONFIDENTIAL and PROPRIETARY information of FCI. No part of the information shown on this document may be used in any way or disclosed to others without the written consent of FCI. Copyright FCI.



FCIconnect.com



PT. NO.	PARTS NAME	CAT. NO.	MATERIAL	Q'TY	NOTE
1	REEL	_____	CARDBOARD	1	COLOR:WHITE/GREY
2	PLASTIC (EMBOSS) TAPE	_____	PET	_____	COLOR:TRANSPARENCY
3	COVER	_____	POLYESTER	_____	COLOR:TRANSPARENCY
4	CONNECTOR	SFW__R-2ST__LF	SEE ATTACHED DWG.	2000	UPPER CONTACT TYPE

NOTES

- THIS IS PLASTIC TAPE PACKAGED CONNECTOR USED FOR FPC/FFC AND COPES WITH AUTOMATIC MOUNTING (SMT).
- SEE JIS C 0806 (PACKING OF ELECTRONIC COMPONENTS ON CONTINUOUS TAPES (SURFACE MOUNTING DEVICES)) FOR SHAPE AND DIMENSIONS OF PLASTIC (EMBOSS) TAPE AND REEL.
- E DIMENSION IS PORTION OF THE CORE.
- A SYMBOL WILL BE NEXT TO ANY DIMENSION, VIEW, OR NOTE WHICH HAS BEEN MODIFIED WITH THE CURRENT DRAWING REVISION.

mat'l. code		surface 58 / tolerance ISO 1302 / ISO 406 / ISO 1101		projection		product family 58RF		CODE JP	
ltr ecn no dr date		tolerances unless otherwise specified		mm		title PLASTIC TAPE PACKAGED 1mm SPACING SMT CONNECTOR (Cat. No. SFW__R-2STE1 LF)			
AA J05-0055 H.T 05-02-04		angles linear ±5		scale		dwg no JSA 95859		sheet 1 of 1 size A4	
AB J06-0398 H.T 06-09-26		±5'		FCI logo		type Product Customer Drawing			
AC S08-0276 DGOH 08-08-22		dr H. TAKAKURA 06-09-26		engr H. TAKAKURA 06-09-26		chr DENNIS GOH 08-08-22		appd JOEY NG 08-08-22	
sheet index		revision AC		sheet 1		Rev. AC			

SC\_SFW10 JSA95857 form: A4

RECOMMENDED CABLE (FPC)



n : NO. OF CONDUCTOR



PT. NO.	PARTS NAME	MATERIAL	THICKNESS (um)
1	BASE FILM	POLYIMIDE OR POLYESTER OR EQUAL	25
2	CONDUCTOR	COPPER FOIL(PLATING:SOLDER 1um MIN.)	35
3	OVERLAY	POLYIMIDE OR POLYESTER OR EQUAL	—
4	SUPPORTING TAPE	POLYESTER OR POLYIMIDE OR EQUAL	188

NOTES

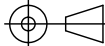
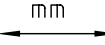
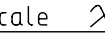
1. NO BURR AT EACH PORTION.
2. NO PEELING IN COMMON USE.
3. TOTAL THICKNESS LIMIT OF EACH MATERIAL (INCLUDING ADHESIVE AGENT) IS SPECIFIED.
4. A  SYMBOL WILL BE NEXT TO ANY DIMENSION, VIEW, OR NOTE WHICH HAS BEEN MODIFIED WITH THE CURRENT DRAWING REVISION.

mat'l. code				surface 58 / tolerance ISO 1302 ISO 406 ISO 1101		projection 		product family 58RF		CODE JP	
ltr ecn no dr date				tolerances unless otherwise specified		mm 		title RECOMMENDED CABLE (Cat. No. SFW__R-1/2__)			
AA J05-0055 H.T 05-02-04				angles linear		scale 		dwg no JSA 91605		sheet 1 of 1 size A4	
AB J06-0398 H.T 06-09-26				dr H. TAKAKURA 06-09-26				type Product Customer Drawing			
AC S08-0276 DGOH 08-08-22				enr H. TAKAKURA 06-09-26							
				chr DENNIS GOH 08-08-22							
				appd JOEY NG 08-08-22							
sheet index		revision sheet		AC 1						Rev. AC	

This document is the property of and embodies CONFIDENTIAL and PROPRIETARY information of FCI. No part of the information shown on this document may be used in any way or disclosed to others without the written consent of FCI. Copyright FCI.





RECOMMENDED CABLE (FFC)



n : NO. OF CONDUCTOR



PT. NO.	PARTS NAME	MATERIAL	NOTE
1	INSULATOR	FLAME RESISTING POLYESTER OR EQUAL	_____
2	CONDUCTOR	COPPER FOIL	PLATING:TIN OR SOLDER 1um MIN.
3	SUPPORTING TAPE	FLAME RESISTING POLYESTER OR EQUAL	_____

NOTES

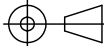
1. NO BURR AT EACH PORTION.
2. NO PEELING IN COMMON USE.
3. A  SYMBOL WILL BE NEXT TO ANY DIMENSION, VIEW, OR NOTE WHICH HAS BEEN MODIFIED WITH THE CURRENT DRAWING REVISION.

mat'l. code				surface 58 / tolerance ISO 1302 ISO 406 ISO 1101		projection 		product family 58RF		CODE JP	
ltr ecn no dr date				tolerances unless otherwise specified		mm		title			
AA J05-0055 H.T 05-02-04				angles linear		mm		RECOMMENDED CABLE			
AB J06-0398 H.T 06-09-26								(Cat. No. SFW__R-1/2__)			
AC S08-0276 DGOH 08-08-22						scale $\times$		dwg no sheet 1 of 1 size			
				dr H. TAKAKURA 06-09-26				JSA 91604 $\Delta$ 4			
				enr H. TAKAKURA 06-09-26				type Product Customer Drawing			
				chr DENNIS GOH 08-08-22							
				appd JOEY NG 08-08-22							
sheet index		revision AC								Rev. AC	
1		1								2	

This document is the property of and embodies CONFIDENTIAL and PROPRIETARY information of FCI. No part of the information shown on this document may be used in any way or disclosed to others without the written consent of FCI. Copyright FCI.



FCIconnect.com



Компания «Life Electronics» занимается поставками электронных компонентов импортного и отечественного производства от производителей и со складов крупных дистрибьюторов Европы, Америки и Азии.

С конца 2013 года компания активно расширяет линейку поставок компонентов по направлению коаксиальный кабель, кварцевые генераторы и конденсаторы (керамические, пленочные, электролитические), за счёт заключения дистрибьюторских договоров

Мы предлагаем:

- Конкурентоспособные цены и скидки постоянным клиентам.
- Специальные условия для постоянных клиентов.
- Подбор аналогов.
- Поставку компонентов в любых объемах, удовлетворяющих вашим потребностям.
- Приемлемые сроки поставки, возможна ускоренная поставка.
- Доставку товара в любую точку России и стран СНГ.
- Комплексную поставку.
- Работу по проектам и поставку образцов.
- Формирование склада под заказчика.
- Сертификаты соответствия на поставляемую продукцию (по желанию клиента).
- Тестирование поставляемой продукции.
- Поставку компонентов, требующих военную и космическую приемку.
- Входной контроль качества.
- Наличие сертификата ISO.

В составе нашей компании организован Конструкторский отдел, призванный помогать разработчикам, и инженерам.

Конструкторский отдел помогает осуществить:

- Регистрацию проекта у производителя компонентов.
- Техническую поддержку проекта.
- Защиту от снятия компонента с производства.
- Оценку стоимости проекта по компонентам.
- Изготовление тестовой платы монтаж и пусконаладочные работы.



Тел: +7 (812) 336 43 04 (многоканальный)

Email: [org@lifeelectronics.ru](mailto:org@lifeelectronics.ru)