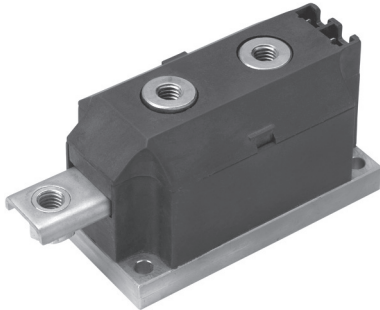

Fast Thyristor/Diode and Thyristor/Thyristor (MAGN-A-PAK Power Modules), 180 A

MAGN-A-PAK
FEATURES

- Fast turn-off thyristor
- Fast recovery diode
- High surge capability
- Electrically isolated baseplate
- 3000 V_{RMS} isolating voltage
- Industrial standard package
- UL approved file E78996
- Compliant to RoHS directive 2002/95/EC

**RoHS
COMPLIANT**
PRODUCT SUMMARY

$I_{T(AV)}$	180 A
Type	Modules - Thyristor, Fast

DESCRIPTION

These series of MAGN-A-PAK modules are intended for applications such as self-commutated inverters, DC choppers, electronic welders, induction heating and others where fast switching characteristics are required.

MAJOR RATINGS AND CHARACTERISTICS

SYMBOL	CHARACTERISTICS	VALUES	UNITS
$I_{T(AV)}$		180	A
	T_C	85	°C
$I_{T(RMS)}$		400	A
I_{TSM}	50 Hz	7130	
	60 Hz	7470	
I^2t	50 Hz	255	kA ² s
	60 Hz	232	
$I^2\sqrt{t}$		2550	kA ² √s
t_q		20/25	μs
t_{rr}		2	
V_{DRM}/V_{RRM}		800/1200	V
T_J	Range	- 40 to 125	°C

ELECTRICAL SPECIFICATIONS
VOLTAGE RATINGS

TYPE NUMBER	VOLTAGE CODE	V_{RRM}/V_{DRM} , MAXIMUM REPETITIVE PEAK REVERSE VOLTAGE V	V_{RSM} , MAXIMUM NON-REPETITIVE PEAK REVERSE VOLTAGE V	I_{RRM}/I_{DRM} MAXIMUM AT $T_J = 125\text{ °C}$ mA
VSK.F180-	08	800	800	50
	12	1200	1200	

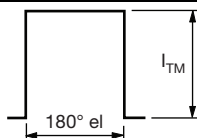
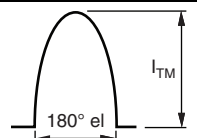
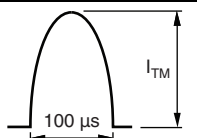
CURRENT CARRYING CAPABILITY							
FREQUENCY							UNITS
50 Hz	370	530	565	800	2400	3150	A
400 Hz	435	650	670	1000	1540	2050	
2500 Hz	290	430	490	720	610	830	
5000 Hz	240	345	390	540	390	540	
10 000 Hz	170	270	290	390	-	-	
Recovery voltage V_r	50		50		50		V
Voltage before turn-on V_d	80 % V_{DRM}		80 % V_{DRM}		80 % V_{DRM}		
Rise of on-state current di/dt	50		-		-		A/ μ s
Case temperature	85	60	85	60	85	60	$^{\circ}$ C
Equivalent values for RC circuit	10/0.47		10/0.47		10/0.47		Ω/μ F

ON-STATE CONDUCTION					
PARAMETER	SYMBOL	TEST CONDITIONS		VALUES	UNITS
Maximum average on-state current at case temperature	$I_{T(AV)}$	180° conduction, half sine wave		180	A
				85	$^{\circ}$ C
Maximum RMS current	$I_{T(RMS)}$	As AC switch		400	A
Maximum peak, one-cycle non-repetitive surge current	I_{TSM}	t = 10 ms	No voltage reapplied	7130	
		t = 8.3 ms	No voltage reapplied	7470	
		t = 10 ms	100 % V_{RRM} reapplied	6000	
		t = 8.3 ms	100 % V_{RRM} reapplied	6280	
Maximum I^2t for fusing	I^2t	t = 10 ms	No voltage reapplied	255	kA ² s
		t = 8.3 ms	No voltage reapplied	232	
		t = 10 ms	100 % V_{RRM} reapplied	180	
		t = 8.3 ms	100 % V_{RRM} reapplied	164	
Maximum $I^2\sqrt{t}$ for fusing	$I^2\sqrt{t}$	t = 0.1 ms to 10 ms, no voltage reapplied		2550	kA ² \sqrt{s}
Low level value or threshold voltage	$V_{T(TO)1}$	(16.7 % $\times \pi \times I_{T(AV)} < I < \pi \times I_{T(AV)}$, $T_J = T_J$ maximum)		1.30	V
High level value of threshold voltage	$V_{T(TO)2}$	(I > $\pi \times I_{T(AV)}$, $T_J = T_J$ maximum)		1.38	
Low level value on-state slope resistance	r_{t1}	(16.7 % $\times \pi \times I_{T(AV)} < I < \pi \times I_{T(AV)}$, $T_J = T_J$ maximum)		0.90	m Ω
High level value on-state slope resistance	r_{t2}	(I > $\pi \times I_{T(AV)}$, $T_J = T_J$ maximum)		0.71	
Maximum on-state voltage drop	V_{TM}	$I_{pk} = 600$ A, $T_J = T_J$ maximum, $t_p = 10$ ms sine pulse		1.84	V
Maximum holding current	I_H	$T_J = 25$ $^{\circ}$ C, $I_T > 30$ A		600	mA
Typical latching current	I_L	$T_J = 25$ $^{\circ}$ C, $V_A = 12$ V, $R_a = 6$ Ω , $I_g = 1$ A		1000	



SWITCHING					
PARAMETER	SYMBOL	TEST CONDITIONS	VALUES		UNITS
			K	J	
Maximum non-repetitive rate of rise	di/dt	Gate drive 20 V, 20 Ω, t _r ≤ 1 ms, V _D = 80 % V _{DRM} T _J = 25 °C	800		A/μs
Maximum recovery time	t _{rr}	I _{TM} = 350 A, di/dt = - 25 A/μs, V _R = 50 V, T _J = 25 °C	2		μs
Maximum turn-off time	t _q	I _{TM} = 750 A; T _J = 125 °C; di/dt = - 25 A/μs; V _R = 50 V; dV/dt = 400 V/μs linear to 80 % V _{DRM}	20	25	

BLOCKING				
PARAMETER	SYMBOL	TEST CONDITIONS	VALUES	UNITS
Maximum critical rate of rise of off-state voltage	dV/dt	T _J = 125 °C, exponential to 67 % V _{DRM}	1000	V/μs
RMS insulation voltage	V _{INS}	50 Hz, circuit to base, all terminals shorted, 25 °C, 1 s	3000	V
Maximum peak reverse and off-state leakage current	I _{RRM} , I _{DRM}	T _J = 125 °C, rated V _{DRM} /V _{RRM} applied	50	mA

TRIGGERING				
PARAMETER	SYMBOL	TEST CONDITIONS	VALUES	UNITS
Maximum peak gate power	P _{GM}	f = 50 Hz, d% = 50	60	W
Maximum peak average gate power	P _{G(AV)}	T _J = 125 °C, f = 50 Hz, d% = 50	10	
Maximum peak positive gate current	I _{GM}	T _J = 125 °C, t _p ≤ 5 ms	10	A
Maximum peak negative gate voltage	- V _{GM}		5	V
Maximum DC gate current required to trigger	I _{GT}	T _J = 25 °C, V _{ak} 12 V, R _a = 6 Ω	200	mA
DC gate voltage required to trigger	V _{GT}		3	V
DC gate current not to trigger	I _{GD}	T _J = 125 °C, rated V _{DRM} applied	20	mA
DC gate voltage not to trigger	V _{GD}		0.25	V

THERMAL AND MECHANICAL SPECIFICATIONS				
PARAMETER	SYMBOL	TEST CONDITIONS	VALUES	UNITS
Maximum junction operating temperature range	T _J		- 40 to 125	°C
Maximum storage temperature range	T _{Stg}		- 40 to 150	
Maximum thermal resistance, junction to case per junction	R _{thJC}	DC operation	0.125	K/W
Maximum thermal resistance, case to heatsink per module	R _{thCS}	Mounting surface, flat and greased	0.02	
Mounting torque ± 10 %	MAP to heatsink busbar to MAP	A mounting compound is recommended. The torque should be rechecked after a period of 3 hours to allow for the spread of the compound. Use of cable lugs is not recommended, busbar should be used and restrained during tightening. Threads must be lubricated with a compound.	4 to 6 (35 to 53)	N · m (lbf · in)
Approximate weight			500	g
			17.8	oz.
Case style			MAGN-A-PAK	

ΔR_{thJC} CONDUCTION				
CONDUCTIONS ANGLE	SINUSOIDAL CONDUCTION	RECTANGULAR CONDUCTION	TEST CONDITIONS	UNITS
180°	0.009	0.006	$T_J = 125\text{ }^\circ\text{C}$	K/W
120°	0.010	0.011		
90°	0.014	0.015		
60°	0.020	0.020		
30°	0.032	0.033		

Note

- Table shows the increment of thermal resistance R_{thJC} when devices operate at different conduction angles than DC

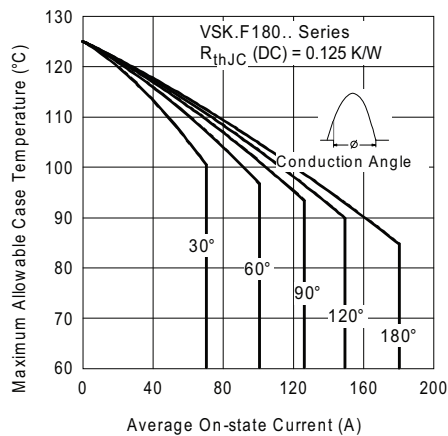

Fig. 1 - Current Ratings Characteristics

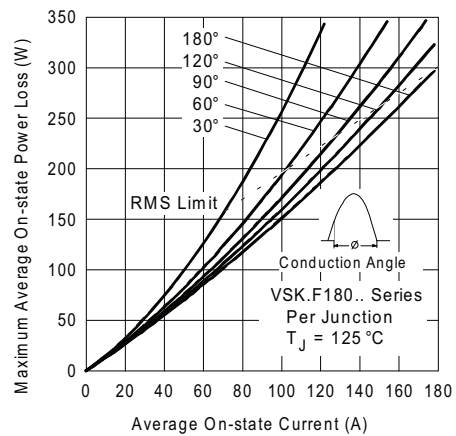

Fig. 3 - On-State Power Loss Characteristics

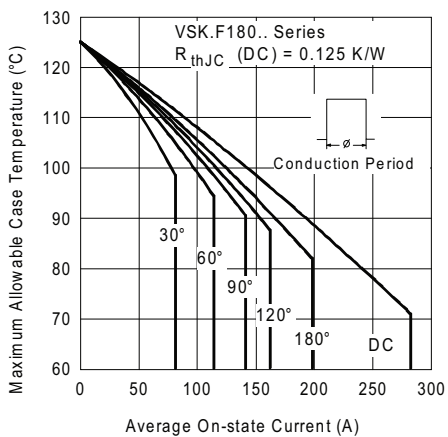

Fig. 2 - Current Ratings Characteristics

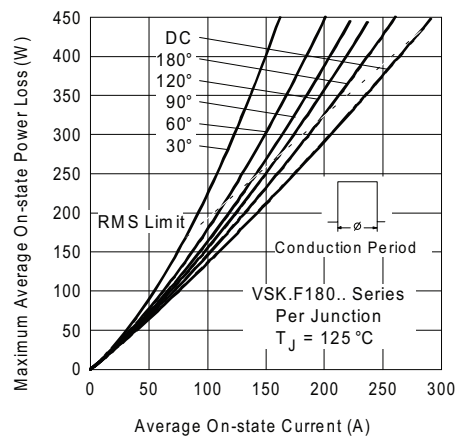

Fig. 4 - On-State Power Loss Characteristics

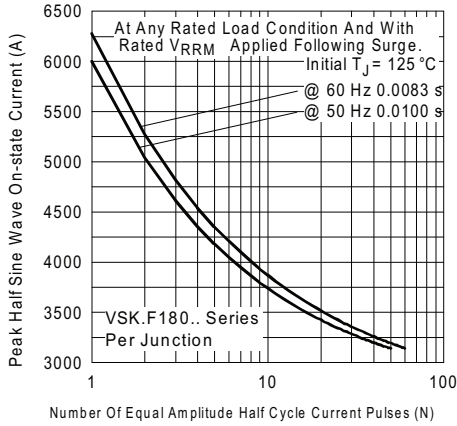

Fig. 5 - Maximum Non-Repetitive Surge Current

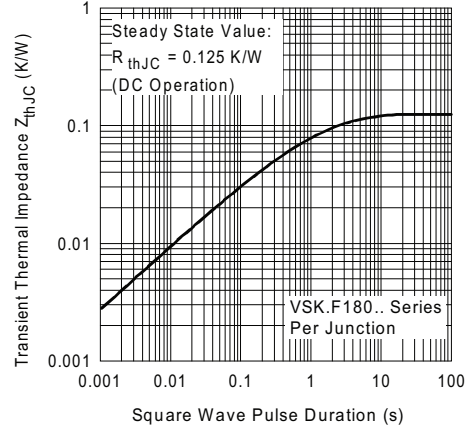

Fig. 8 - Thermal Impedance Z_{thJC} Characteristics

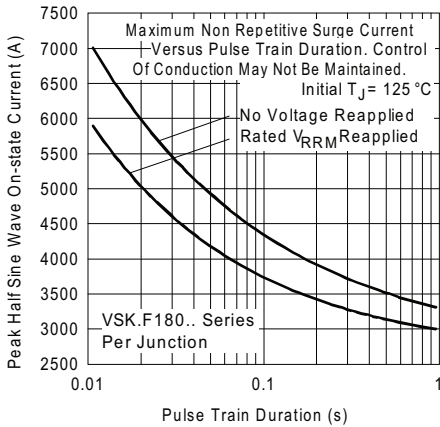

Fig. 6 - Maximum Non-Repetitive Surge Current

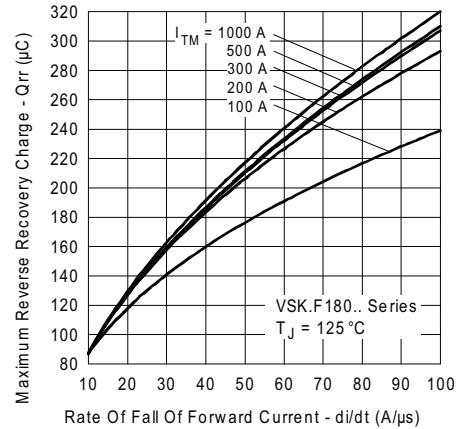

Fig. 9 - Reverse Recovery Charge Characteristics

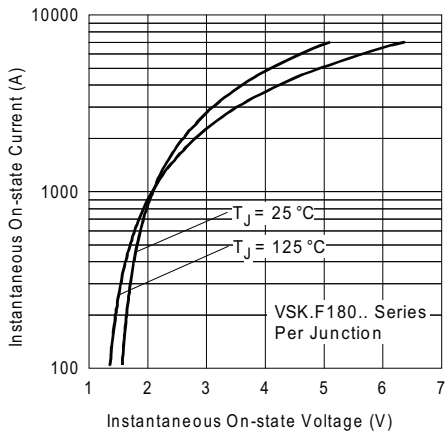

Fig. 7 - On-State Voltage Drop Characteristics

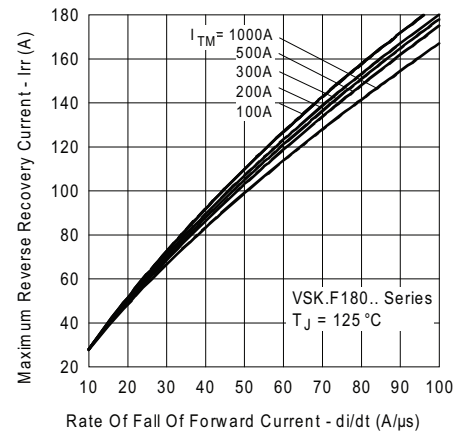

Fig. 10 - Reverse Recovery Current Characteristics

VSK.F180..P Series



Vishay Semiconductors Fast Thyristor/Diode and Thyristor/Thyristor (MAGN-A-PAK Power Modules), 180 A

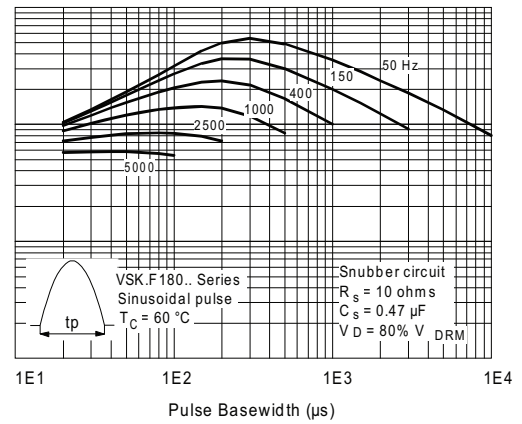
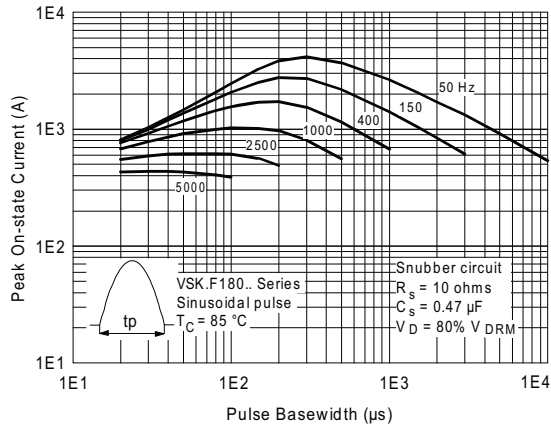

Fig. 11 - Frequency Characteristics

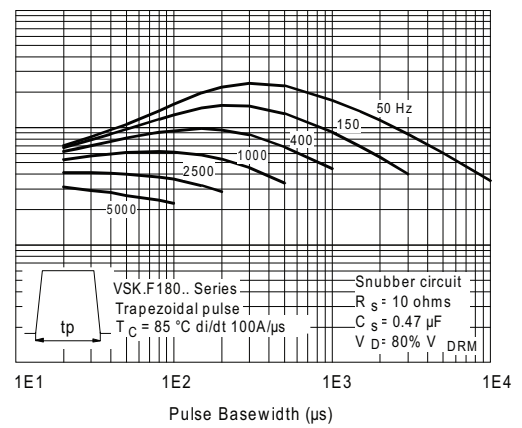
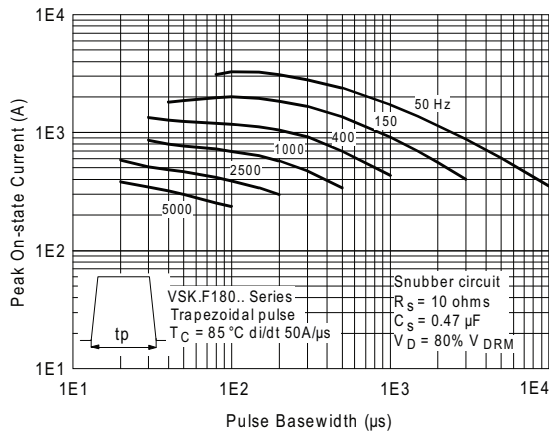

Fig. 12 - Frequency Characteristics

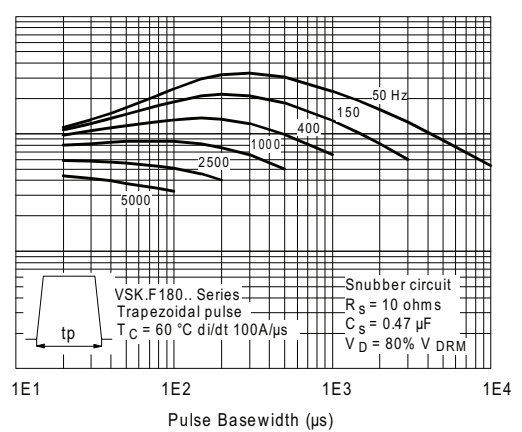
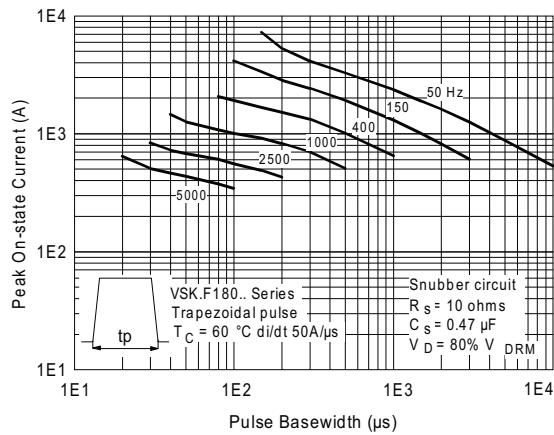

Fig. 13 - Frequency Characteristics

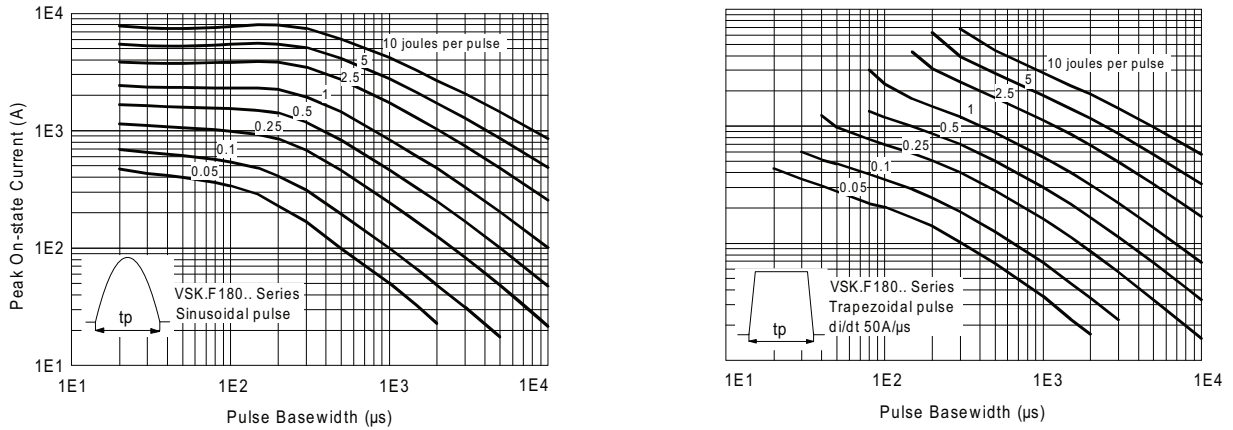

Fig. 14 - Maximum On-State Energy Power Loss Characteristics

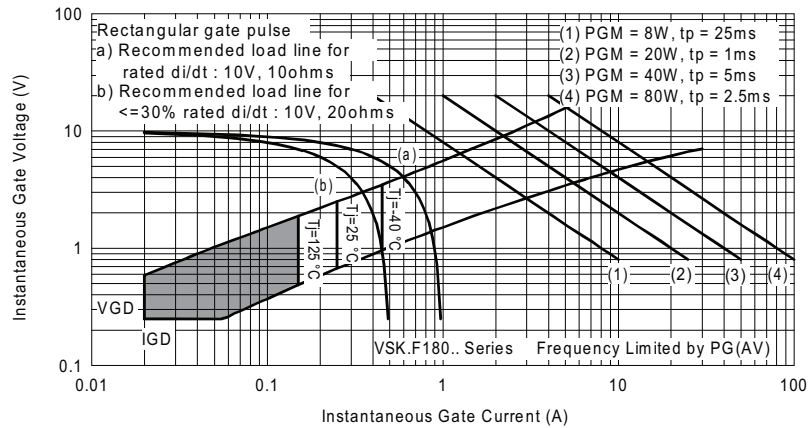

Fig. 15 - Gate Characteristics

VSK.F180..P Series



Vishay Semiconductors Fast Thyristor/Diode and Thyristor/Thyristor
(MAGN-A-PAK Power Modules), 180 A

ORDERING INFORMATION TABLE

Device code	VSK	T	F	180	-	12	H	K	P
	①	②	③	④		⑤	⑥	⑦	⑧

- 1** - Module type
- 2** - Circuit configuration (see circuit configuration table)
- 3** - Fast SCR
- 4** - Current rating: $I_{T(AV)} \times 10$ rounded
- 5** - Voltage code $\times 100 = V_{RRM}$ (see Voltage Ratings table)
- 6** - dV/dt code: $H \leq 400 \text{ V}/\mu\text{s}$
- 7** - t_q code: $K \leq 20 \mu\text{s}$
 $J \leq 25 \mu\text{s}$
- 8** - P = Lead (Pb)-free

Note

- To order the optional hardware go to www.vishay.com/doc?95172

CIRCUIT CONFIGURATION		
CIRCUIT DESCRIPTION	CIRCUIT CONFIGURATION CODE	CIRCUIT DRAWING
Two SCRs common cathodes	U	<p>VSKUF..</p>
SCR/diode common cathodes	K	<p>VSKKF..</p>
Two SCRs common anodes	V	<p>VSKVF..</p>



CIRCUIT CONFIGURATION		
CIRCUIT DESCRIPTION	CIRCUIT CONFIGURATION CODE	CIRCUIT DRAWING
SCR/diode common anodes	N	<p>VSKNF..</p>
SCR/diode doubler circuit, negative control	L	<p>VSKLF..</p>
Two SCRs doubler circuit	T	<p>VSKTF..</p>
SCR/diode doubler circuit, positive control	H	<p>VSKHF..</p>

LINKS TO RELATED DOCUMENTS	
Dimensions	www.vishay.com/doc?95086

MAGN-A-PAK

DIMENSIONS in millimeters (inches)



Notes

- Dimensions are nominal
- Full engineering drawings are available on request
- UL identification number for gate and cathode wire: UL 1385
- UL identification number for package: UL 94 V-0



Disclaimer

ALL PRODUCT, PRODUCT SPECIFICATIONS AND DATA ARE SUBJECT TO CHANGE WITHOUT NOTICE TO IMPROVE RELIABILITY, FUNCTION OR DESIGN OR OTHERWISE.

Vishay Intertechnology, Inc., its affiliates, agents, and employees, and all persons acting on its or their behalf (collectively, "Vishay"), disclaim any and all liability for any errors, inaccuracies or incompleteness contained in any datasheet or in any other disclosure relating to any product.

Vishay makes no warranty, representation or guarantee regarding the suitability of the products for any particular purpose or the continuing production of any product. To the maximum extent permitted by applicable law, Vishay disclaims (i) any and all liability arising out of the application or use of any product, (ii) any and all liability, including without limitation special, consequential or incidental damages, and (iii) any and all implied warranties, including warranties of fitness for particular purpose, non-infringement and merchantability.

Statements regarding the suitability of products for certain types of applications are based on Vishay's knowledge of typical requirements that are often placed on Vishay products in generic applications. Such statements are not binding statements about the suitability of products for a particular application. It is the customer's responsibility to validate that a particular product with the properties described in the product specification is suitable for use in a particular application. Parameters provided in datasheets and/or specifications may vary in different applications and performance may vary over time. All operating parameters, including typical parameters, must be validated for each customer application by the customer's technical experts. Product specifications do not expand or otherwise modify Vishay's terms and conditions of purchase, including but not limited to the warranty expressed therein.

Except as expressly indicated in writing, Vishay products are not designed for use in medical, life-saving, or life-sustaining applications or for any other application in which the failure of the Vishay product could result in personal injury or death. Customers using or selling Vishay products not expressly indicated for use in such applications do so at their own risk and agree to fully indemnify and hold Vishay and its distributors harmless from and against any and all claims, liabilities, expenses and damages arising or resulting in connection with such use or sale, including attorneys fees, even if such claim alleges that Vishay or its distributor was negligent regarding the design or manufacture of the part. Please contact authorized Vishay personnel to obtain written terms and conditions regarding products designed for such applications.

No license, express or implied, by estoppel or otherwise, to any intellectual property rights is granted by this document or by any conduct of Vishay. Product names and markings noted herein may be trademarks of their respective owners.

Material Category Policy

Vishay Intertechnology, Inc. hereby certifies that all its products that are identified as RoHS-Compliant fulfill the definitions and restrictions defined under Directive 2011/65/EU of The European Parliament and of the Council of June 8, 2011 on the restriction of the use of certain hazardous substances in electrical and electronic equipment (EEE) - recast, unless otherwise specified as non-compliant.

Please note that some Vishay documentation may still make reference to RoHS Directive 2002/95/EC. We confirm that all the products identified as being compliant to Directive 2002/95/EC conform to Directive 2011/65/EU.

Компания «Life Electronics» занимается поставками электронных компонентов импортного и отечественного производства от производителей и со складов крупных дистрибьюторов Европы, Америки и Азии.

С конца 2013 года компания активно расширяет линейку поставок компонентов по направлению коаксиальный кабель, кварцевые генераторы и конденсаторы (керамические, пленочные, электролитические), за счёт заключения дистрибьюторских договоров

Мы предлагаем:

- Конкурентоспособные цены и скидки постоянным клиентам.
- Специальные условия для постоянных клиентов.
- Подбор аналогов.
- Поставку компонентов в любых объемах, удовлетворяющих вашим потребностям.
- Приемлемые сроки поставки, возможна ускоренная поставка.
- Доставку товара в любую точку России и стран СНГ.
- Комплексную поставку.
- Работу по проектам и поставку образцов.
- Формирование склада под заказчика.
- Сертификаты соответствия на поставляемую продукцию (по желанию клиента).
- Тестирование поставляемой продукции.
- Поставку компонентов, требующих военную и космическую приемку.
- Входной контроль качества.
- Наличие сертификата ISO.

В составе нашей компании организован Конструкторский отдел, призванный помогать разработчикам, и инженерам.

Конструкторский отдел помогает осуществить:

- Регистрацию проекта у производителя компонентов.
- Техническую поддержку проекта.
- Защиту от снятия компонента с производства.
- Оценку стоимости проекта по компонентам.
- Изготовление тестовой платы монтаж и пусконаладочные работы.



Тел: +7 (812) 336 43 04 (многоканальный)
Email: org@lifeelectronics.ru