

FEATURES

Input voltage range: 2.3 V to 5.5 V

Output voltage range: 1.2 V to 3.3 V

Output current: 150 mA

Low quiescent current

$I_{GND} = 11 \mu\text{A}$ with 0 μA load

$I_{GND} = 30 \mu\text{A}$ with 150 mA load

Low shutdown current: <1 μA

Low dropout voltage

90 mV @ 150 mA load

High PSRR

70 dB @ 1 kHz at $V_{OUT} = 1.2 \text{ V}$

70 dB @ 10 kHz at $V_{OUT} = 1.2 \text{ V}$

Low noise: 40 μV rms at $V_{OUT} = 1.2 \text{ V}$

No noise bypass capacitor required

Output voltage accuracy: $\pm 1\%$

Stable with a small 1 μF ceramic output capacitor

Current limit and thermal overload protection

Logic controlled enable

5-lead TSOT package

4-ball 0.4 mm pitch WLCSP

APPLICATIONS

Mobile phones

Digital cameras and audio devices

Portable and battery-powered equipment

Post dc-to-dc regulation

Post regulation

GENERAL DESCRIPTION

The ADP121 is a quiescent current, low dropout, linear regulator that operates from 2.3 V to 5.5 V and provides up to 150 mA of output current. The low 135 mV dropout voltage at 150 mA load improves efficiency and allows operation over a wide input voltage range. The low 30 μA of quiescent current at full load makes the ADP121 ideal for battery-operated portable equipment.

TYPICAL APPLICATION CIRCUITS

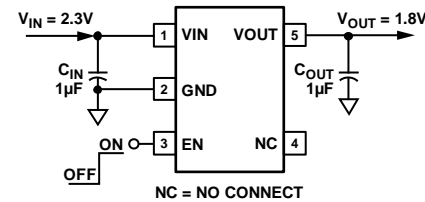

Figure 1. ADP121 TSOT with Fixed Output Voltage, 1.8 V

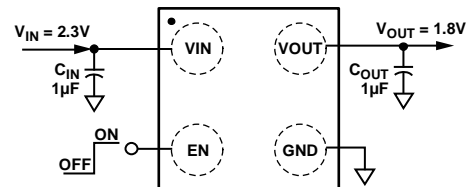

Figure 2. ADP121 WLCSP with Fixed Output Voltage, 1.8 V

The ADP121 is available in output voltages ranging from 1.2 V to 3.3 V. The parts are optimized for stable operation with small 1 μF ceramic output capacitors. The ADP121 delivers good transient performance with minimal board area.

Short-circuit protection and thermal overload protection circuits prevent damage in adverse conditions. The ADP121 is available in a tiny 5-lead TSOT and 4-ball 0.4 mm pitch halide-free WLCSP packages and utilizes the smallest footprint solution to meet a variety of portable applications.

Rev. G

Information furnished by Analog Devices is believed to be accurate and reliable. However, no responsibility is assumed by Analog Devices for its use, nor for any infringements of patents or other rights of third parties that may result from its use. Specifications subject to change without notice. No license is granted by implication or otherwise under any patent or patent rights of Analog Devices. Trademarks and registered trademarks are the property of their respective owners.

One Technology Way, P.O. Box 9106, Norwood, MA 02062-9106, U.S.A.

Tel: 781.329.4700

www.analog.com

Fax: 781.461.3113 ©2008–2012 Analog Devices, Inc. All rights reserved.

TABLE OF CONTENTS

Features	1	Typical Performance Characteristics	7
Applications.....	1	Theory of Operation	11
Typical Application Circuits.....	1	Applications Information	12
General Description	1	Capacitor Selection	12
Revision History	2	Undervoltage Lockout	13
Specifications.....	3	Enable Feature	13
Recommended Specifications: Input and Output Capacitors	4	Current Limit and Thermal Overload Protection	14
Absolute Maximum Ratings.....	5	Thermal Considerations.....	14
Thermal Data	5	PCB Layout Considerations.....	17
Thermal Resistance	5	Outline Dimensions	18
ESD Caution.....	5	Ordering Guide	19
Pin Configurations and Function Descriptions	6		
		Changes to Table 3.....	5
		Changes to Figure 46 Caption and Figure 47 Caption	17
		Changes to Ordering Guide	19
		9/09—Rev. A to Rev. B	
		Updated Outline Dimensions	18
		Changes to Ordering Guide	19
		3/09—Rev. 0 to Rev. A	
		Changes to Features and General Description Sections	1
		Changes to Input and Output Capacitor Parameter	4
		Changes to Figure 17 to Figure 20.....	9
		Changes to Figure 49.....	17
		Added Figure 50	17
		Changes to Ordering Guide	19
		7/08—Revision 0: Initial Version	

REVISION HISTORY

8/12—Rev. F to Rev. G

Change to Ordering Guide..... 19

7/12—Rev. E to Rev. F

Updated Outline Dimensions

Change to Ordering Guide..... 19

8/11—Rev. D to Rev. E

Changes to Figure 22..... 9

Changes to Ordering Guide

1/10—Rev. C to Rev. D

Changes to Ordering Guide

11/09—Rev. B to Rev. C

Changes to Figure 1, Figure 2, and General Description Section..... 1

SPECIFICATIONS

$V_{IN} = (V_{OUT} + 0.5 \text{ V})$ or 2.3 V, whichever is greater; $EN = V_{IN}$; $I_{OUT} = 10 \text{ mA}$; $C_{IN} = C_{OUT} = 1 \text{ }\mu\text{F}$; $T_A = 25^\circ\text{C}$, unless otherwise noted.

Table 1.

Parameter	Symbol	Conditions	Min	Typ	Max	Unit
INPUT VOLTAGE RANGE	V_{IN}	$T_J = -40^\circ\text{C}$ to $+125^\circ\text{C}$	2.3		5.5	V
OPERATING SUPPLY CURRENT	I_{GND}	$I_{OUT} = 0 \text{ }\mu\text{A}$ $I_{OUT} = 0 \text{ }\mu\text{A}$, $T_J = -40^\circ\text{C}$ to $+125^\circ\text{C}$ $I_{OUT} = 10 \text{ mA}$ $I_{OUT} = 10 \text{ mA}$, $T_J = -40^\circ\text{C}$ to $+125^\circ\text{C}$ $I_{OUT} = 150 \text{ mA}$ $I_{OUT} = 150 \text{ mA}$, $T_J = -40^\circ\text{C}$ to $+125^\circ\text{C}$		11 15 30	21 29 40	μA μA μA μA μA
SHUTDOWN CURRENT	I_{GND-SD}	$EN = GND$ $EN = GND$, $T_J = -40^\circ\text{C}$ to $+125^\circ\text{C}$		0.1	1.5	μA μA
FIXED OUTPUT VOLTAGE ACCURACY	V_{OUT}	$I_{OUT} = 10 \text{ mA}$ $100 \text{ }\mu\text{A} < I_{OUT} < 150 \text{ mA}$, $V_{IN} = (V_{OUT} + 0.5 \text{ V})$ to 5.5 V $100 \text{ }\mu\text{A} < I_{OUT} < 150 \text{ mA}$, $V_{IN} = (V_{OUT} + 0.5 \text{ V})$ to 5.5 V $T_J = -40^\circ\text{C}$ to $+125^\circ\text{C}$	-1 -2 -3		+1 +2 +3	% % %
REGULATION						
Line Regulation	$\Delta V_{OUT}/\Delta V_{IN}$	$V_{IN} = (V_{OUT} + 0.5 \text{ V})$ to 5.5 V, $I_{OUT} = 1 \text{ mA}$ $T_J = -40^\circ\text{C}$ to $+125^\circ\text{C}$	-0.03		+0.03	%/V
Load Regulation ¹	$\Delta V_{OUT}/\Delta I_{OUT}$	$I_{OUT} = 1 \text{ mA}$ to 150 mA $I_{OUT} = 1 \text{ mA}$ to 150 mA $T_J = -40^\circ\text{C}$ to $+125^\circ\text{C}$		0.001	0.005	%/mA %/mA
DROPOUT VOLTAGE ²	$V_{DROPOUT}$	$V_{OUT} = 3.3 \text{ V}$				
TSOT		$I_{OUT} = 10 \text{ mA}$ $I_{OUT} = 10 \text{ mA}$, $T_J = -40^\circ\text{C}$ to $+125^\circ\text{C}$ $I_{OUT} = 150 \text{ mA}$ $I_{OUT} = 150 \text{ mA}$, $T_J = -40^\circ\text{C}$ to $+125^\circ\text{C}$		8 120	12 180	mV mV mV
WLCSP		$I_{OUT} = 10 \text{ mA}$ $I_{OUT} = 10 \text{ mA}$, $T_J = -40^\circ\text{C}$ to $+125^\circ\text{C}$ $I_{OUT} = 150 \text{ mA}$ $I_{OUT} = 150 \text{ mA}$, $T_J = -40^\circ\text{C}$ to $+125^\circ\text{C}$		6 90	9 135	mV mV mV
START-UP TIME ³	$T_{START-UP}$	$V_{OUT} = 3.3 \text{ V}$		120		μs
CURRENT-LIMIT THRESHOLD ⁴	I_{LIMIT}		160	225	350	mA
THERMAL SHUTDOWN						
Thermal Shutdown Threshold	TS_{SD}	T_J rising		150		$^\circ\text{C}$
Thermal Shutdown Hysteresis	TS_{SD-HYS}			15		$^\circ\text{C}$
EN INPUT						
EN Input Logic High	V_{IH}	$2.3 \text{ V} \leq V_{IN} \leq 5.5 \text{ V}$	1.2			V
EN Input Logic Low	V_{IL}	$2.3 \text{ V} \leq V_{IN} \leq 5.5 \text{ V}$			0.4	V
EN Input Leakage Current	$V_{I-LEAKAGE}$	$EN = VIN$ or GND $EN = VIN$ or GND, $T_J = -40^\circ\text{C}$ to $+125^\circ\text{C}$		0.05	1	μA
UNDERVOLTAGE LOCKOUT						
Input Voltage Rising	$UVLO_{RISE}$				2.25	V
Input Voltage Falling	$UVLO_{FALL}$		1.5			V
Hysteresis	$UVLO_{HYS}$			120		mV
OUTPUT NOISE	OUT_{NOISE}	10 Hz to 100 kHz, $V_{IN} = 5 \text{ V}$, $V_{OUT} = 3.3 \text{ V}$ 10 Hz to 100 kHz, $V_{IN} = 5 \text{ V}$, $V_{OUT} = 2.5 \text{ V}$ 10 Hz to 100 kHz, $V_{IN} = 5 \text{ V}$, $V_{OUT} = 1.2 \text{ V}$		65 52 40		$\mu\text{V rms}$ $\mu\text{V rms}$ $\mu\text{V rms}$

Parameter	Symbol	Conditions	Min	Typ	Max	Unit
POWER SUPPLY REJECTION RATIO	PSRR	10 kHz, $V_{IN} = 5\text{ V}$, $V_{OUT} = 3.3\text{ V}$		60		dB
		10 kHz, $V_{IN} = 5\text{ V}$, $V_{OUT} = 2.5\text{ V}$		66		dB
		10 kHz, $V_{IN} = 5\text{ V}$, $V_{OUT} = 1.2\text{ V}$		70		dB

¹ Based on an end-point calculation using 1 mA and 100 mA loads. See Figure 6 for typical load regulation performance for loads less than 1 mA.

² Dropout voltage is defined as the input-to-output voltage differential when the input voltage is set to the nominal output voltage. This applies only for output voltages above 2.3 V.

³ Start-up time is defined as the time between the rising edge of EN to VOUT being at 90% of its nominal value.

⁴ Current-limit threshold is defined as the current at which the output voltage drops to 90% of the specified typical value. For example, the current limit for a 3.0 V output voltage is defined as the current that causes the output voltage to drop to 90% of 3.0 V, or 2.7 V.

RECOMMENDED SPECIFICATIONS: INPUT AND OUTPUT CAPACITORS

Table 2.

Parameter	Symbol	Conditions	Min	Typ	Max	Unit
INPUT AND OUTPUT CAPACITOR ¹						
Minimum Input and Output Capacitance	C_{MIN}	$T_A = -40^\circ\text{C}$ to $+125^\circ\text{C}$	0.70			μF
Capacitor ESR	R_{ESR}	$T_A = -40^\circ\text{C}$ to $+125^\circ\text{C}$	0.001		1	Ω

¹ The minimum input and output capacitance should be greater than 0.70 μF over the full range of operating conditions. The full range of operating conditions in the application must be considered during device selection to ensure that the minimum capacitance specification is met. X7R and X5R type capacitors are recommended; Y5V and Z5U capacitors are not recommended for use with any LDO.

ABSOLUTE MAXIMUM RATINGS

Table 3.

Parameter	Rating
VIN to GND	−0.3 V to +6.5 V
VOUT to GND	−0.3 V to VIN
EN to GND	−0.3 V to +6.5 V
Storage Temperature Range	−65°C to +150°C
Operating Junction Temperature Range	−40°C to +125°C
Soldering Conditions	JEDEC J-STD-020

Stresses above those listed under Absolute Maximum Ratings may cause permanent damage to the device. This is a stress rating only; functional operation of the device at these or any other conditions above those indicated in the operational section of this specification is not implied. Exposure to absolute maximum rating conditions for extended periods may affect device reliability.

THERMAL DATA

Absolute maximum ratings apply individually only, not in combination. The ADP121 can be damaged when the junction temperature limits are exceeded. Monitoring the ambient temperature does not guarantee that the junction temperature (T_J) is within the specified temperature limits. In applications with high power dissipation and poor thermal resistance, the maximum ambient temperature may have to be derated.

In applications with moderate power dissipation and low PCB thermal resistance, the maximum ambient temperature can exceed the maximum limit as long as the junction temperature is within specification limits. T_J of the device is dependent on the ambient temperature (T_A), the power dissipation of the device (P_D), and the junction-to-ambient thermal resistance of the package (θ_{JA}). T_J is calculated from T_A and P_D using the following formula:

$$T_J = T_A + (P_D \times \theta_{JA})$$

Junction-to-ambient thermal resistance, θ_{JA} , is based on modeling and calculation using a four-layer board. The junction-to-ambient thermal resistance is highly dependent on the application and board layout. In applications where high maximum power dissipation exists, close attention to thermal board design is required. The value of θ_{JA} may vary, depending on PCB material, layout, and environmental conditions. The specified values of θ_{JA} are based on a 4-layer, 4" × 3", circuit board. Refer to JESD 51-7 and JESD 51-9 for detailed information on the board construction. For additional information, see AN-617 Application Note, *MicroCSP™ Wafer Level Chip Scale Package*.

Ψ_{JB} is the junction-to-board thermal characterization parameter measured in °C/W. Ψ_{JB} is based on modeling and calculation using a four-layer board. The JESD51-12 *Guidelines for Reporting and Using Package Thermal Information* states that thermal characterization parameters are not the same as thermal resistances. Ψ_{JB} measures the component power flowing through multiple thermal paths rather than a single path as in thermal resistance, θ_{JB} . Therefore, Ψ_{JB} thermal paths include convection from the top of the package as well as radiation from the package, factors that make Ψ_{JB} more useful in real-world applications. Maximum T_J is calculated from the board temperature (T_B) and P_D using the following formula:

$$T_J = T_B + (P_D \times \Psi_{JB})$$

Refer to JESD51-8 and JESD51-12 for more detailed information about Ψ_{JB} .

THERMAL RESISTANCE

θ_{JA} and Ψ_{JB} are specified for the worst-case conditions, that is, a device soldered in a circuit board for surface-mount packages.

Table 4. Thermal Resistance

Package Type	θ_{JA}	Ψ_{JB}	Unit
5-Lead TSOT	170	43	°C/W
4-Ball 0.4 mm Pitch WLCSP	260	58	°C/W

ESD CAUTION



ESD (electrostatic discharge) sensitive device. Charged devices and circuit boards can discharge without detection. Although this product features patented or proprietary protection circuitry, damage may occur on devices subjected to high energy ESD. Therefore, proper ESD precautions should be taken to avoid performance degradation or loss of functionality.

PIN CONFIGURATIONS AND FUNCTION DESCRIPTIONS

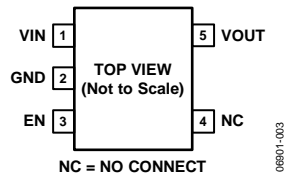

Figure 3. 5-Lead TSOT Pin Configuration

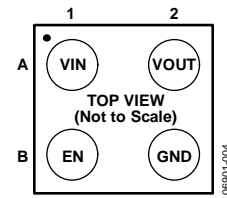

Figure 4. 4-Ball WLCSP Pin Configuration

Table 5. Pin Function Descriptions

Pin No.		Mnemonic	Description
TSOT	WLCSP		
1	A1	VIN	Regulator Input Supply. Bypass VIN to GND with a 1 μ F or larger capacitor.
2	B2	GND	Ground.
3	B1	EN	Enable Input. Drive EN high to turn on the regulator; drive EN low to turn off the regulator. For automatic startup, connect EN to VIN.
4	N/A	NC	No Connect. Not connected internally.
5	A2	VOUT	Regulated Output Voltage. Bypass VOUT to GND with a 1 μ F or greater capacitor.

TYPICAL PERFORMANCE CHARACTERISTICS

$V_{IN} = 2.3\text{ V}$, $V_{OUT} = 1.8\text{ V}$, $I_{OUT} = 10\text{ mA}$, $C_{IN} = C_{OUT} = 1\text{ }\mu\text{F}$, $T_A = 25^\circ\text{C}$, unless otherwise noted.

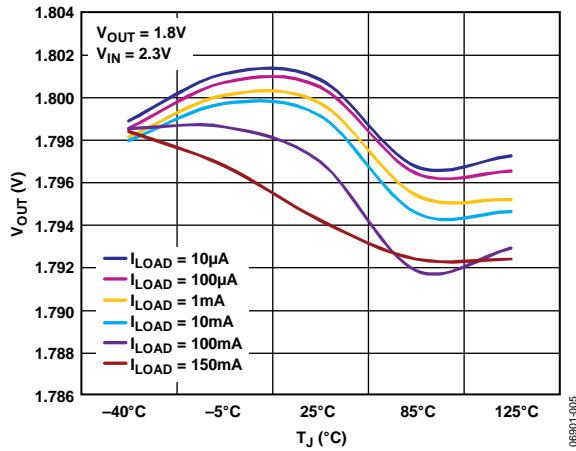

Figure 5. Output Voltage vs. Junction Temperature

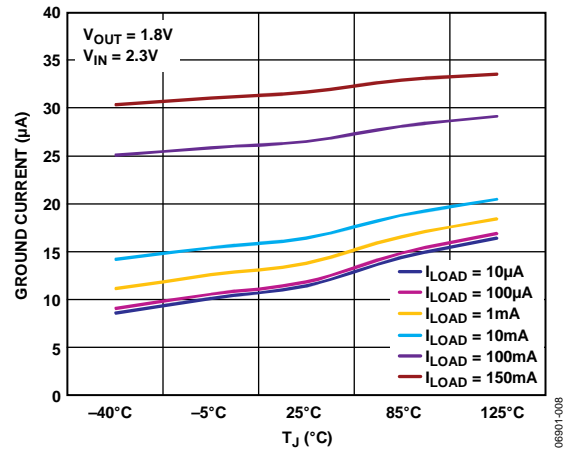

Figure 8. Ground Current vs. Junction Temperature

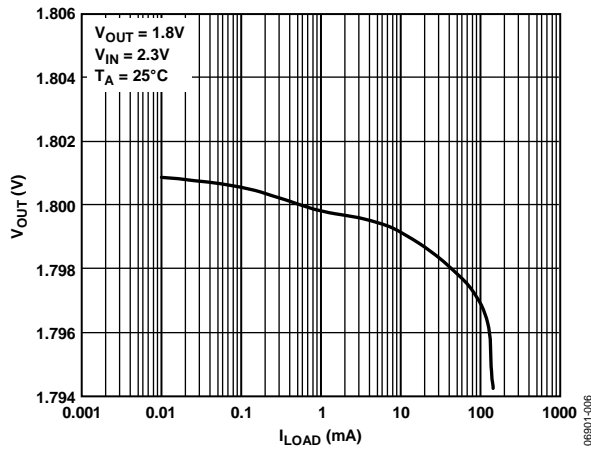

Figure 6. Output Voltage vs. Load Current

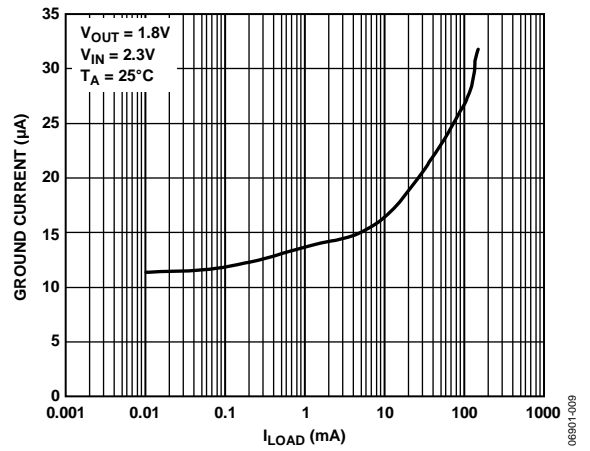

Figure 9. Ground Current vs. Load Current

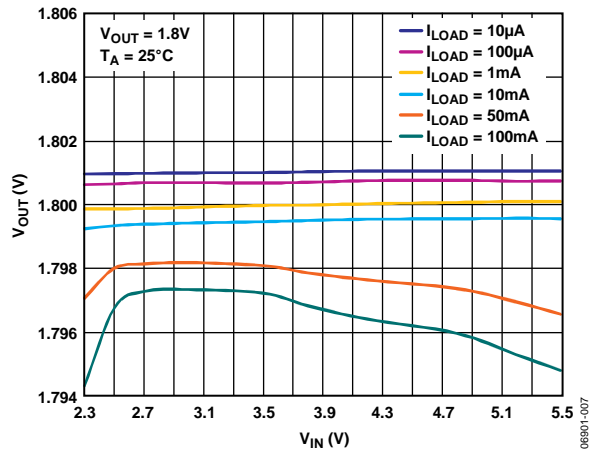

Figure 7. Output Voltage vs. Input Voltage

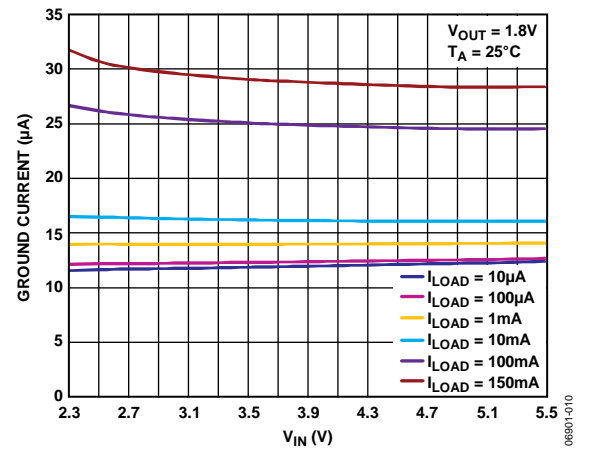

Figure 10. Ground Current vs. Input Voltage

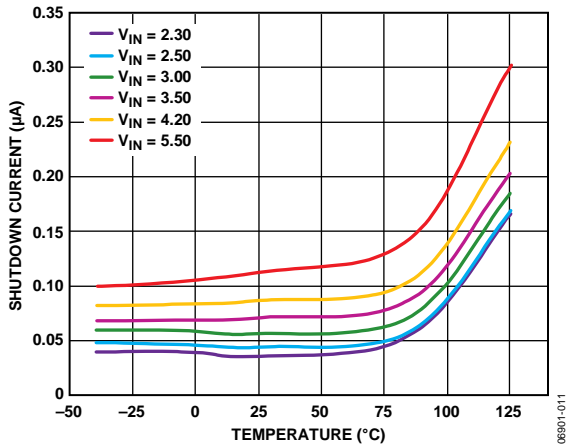

Figure 11. Shutdown Current vs. Temperature at Various Input Voltages

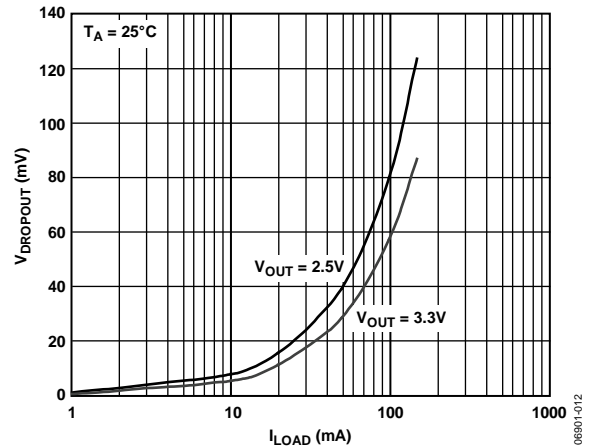

Figure 14. Dropout Voltage vs. Load Current, WLCSF

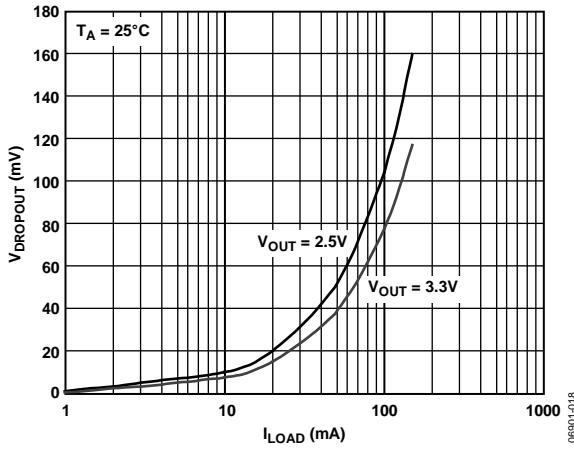

Figure 12. Dropout Voltage vs. Load Current, TSOT

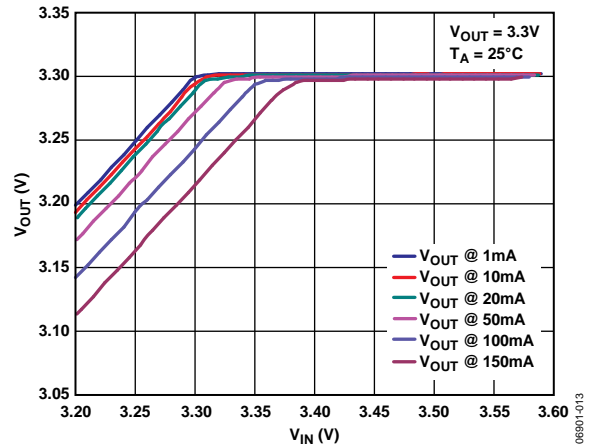

Figure 15. Output Voltage vs. Input Voltage (In Dropout), WLCSF

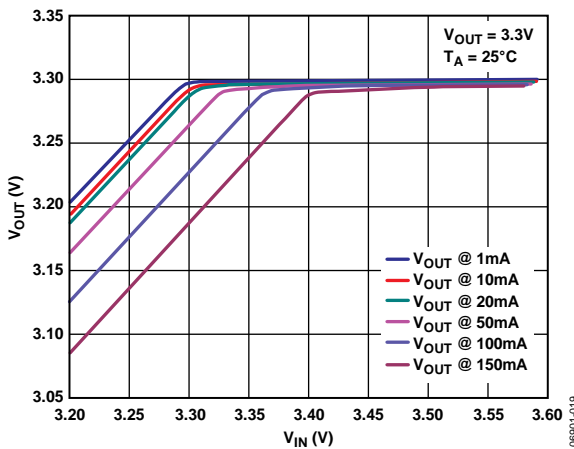

Figure 13. Output Voltage vs. Input Voltage (In Dropout), TSOT

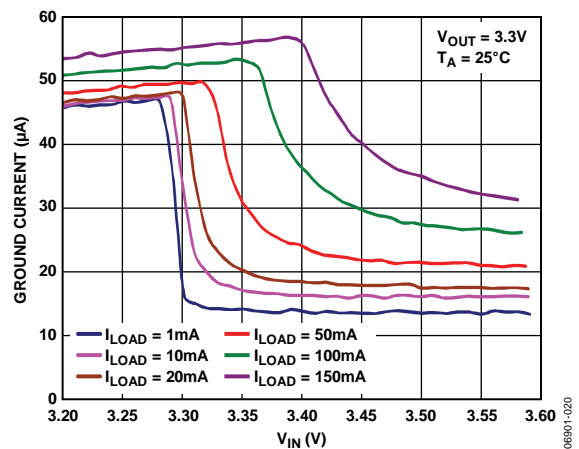

Figure 16. Ground Current vs. Input Voltage (In Dropout)

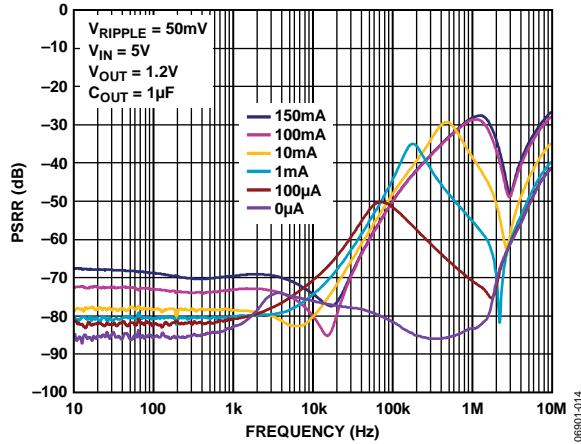

Figure 17. Power Supply Rejection Ratio vs. Frequency

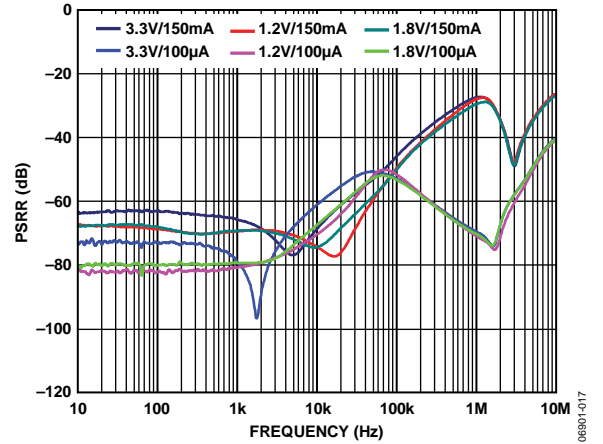

Figure 20. Power Supply Rejection Ratio vs. Frequency at Various Output Voltages and Load Currents

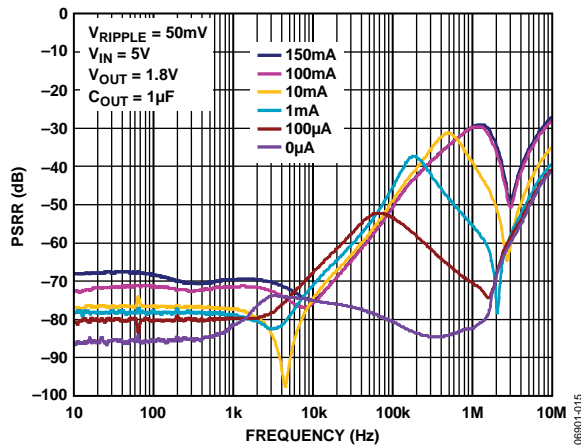

Figure 18. Power Supply Rejection Ratio vs. Frequency

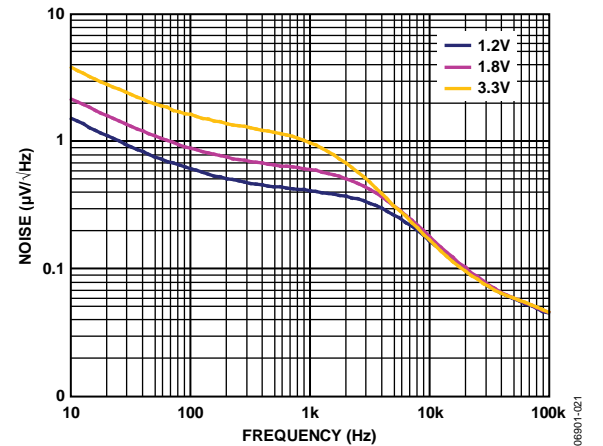

Figure 21. Output Noise Spectrum, $V_{IN} = 5V$, $I_{LOAD} = 10mA$, $C_{OUT} = 1\mu F$

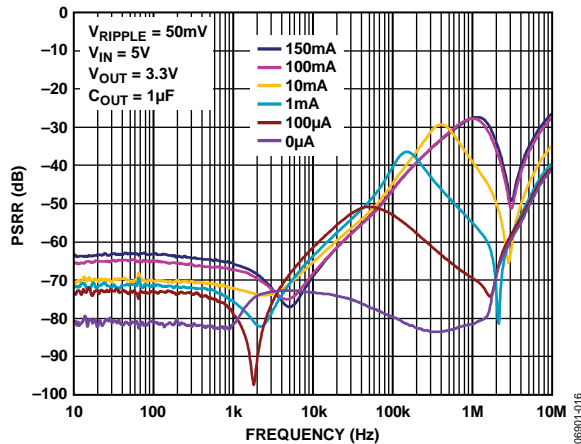

Figure 19. Power Supply Rejection Ratio vs. Frequency

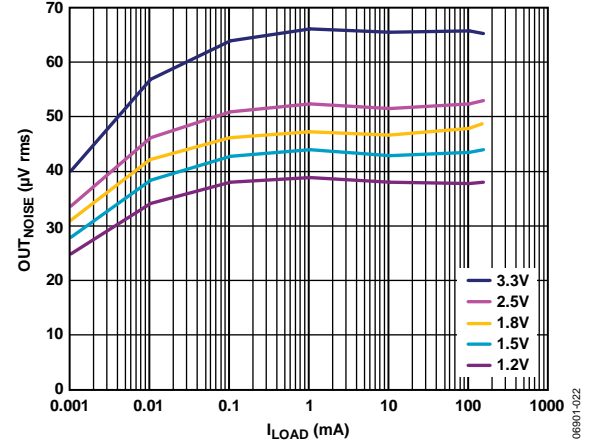

Figure 22. Output Noise vs. Load Current and Output Voltage, $V_{IN} = 5V$, $C_{OUT} = 1\mu F$

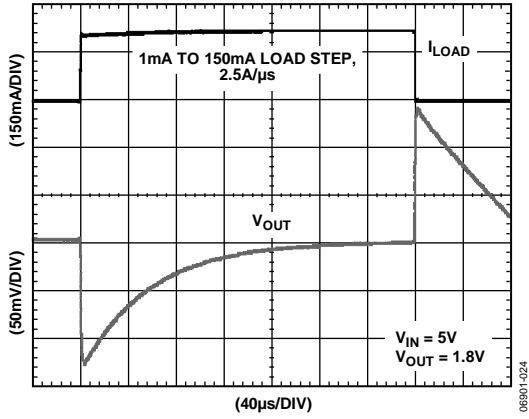

Figure 23. Load Transient Response, $C_{IN} = C_{OUT} = 1 \mu F$

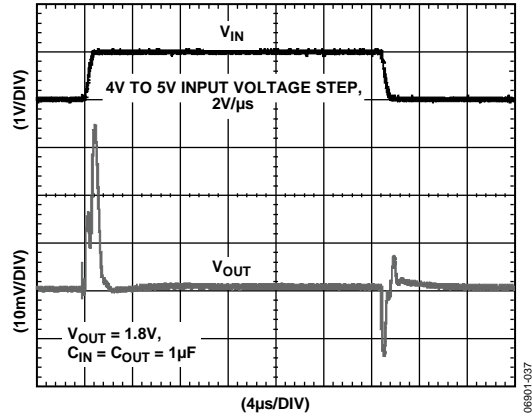

Figure 25. Line Transient Response, Load Current = 150 mA

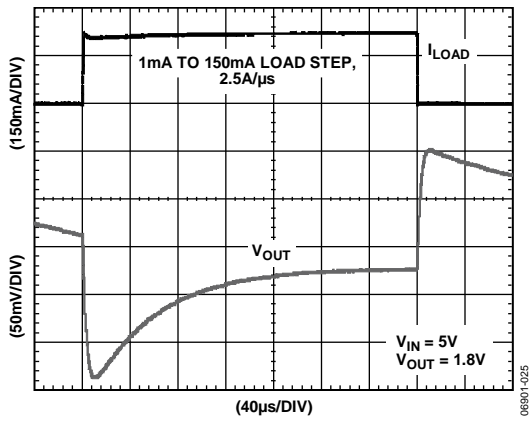

Figure 24. Load Transient Response, $C_{IN} = C_{OUT} = 4.7 \mu F$

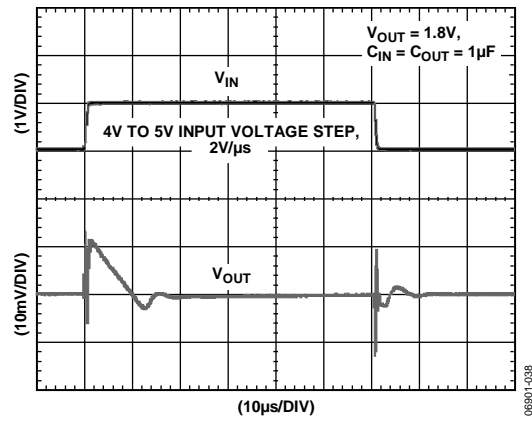

Figure 26. Line Transient Response, Load Current = 1 mA

THEORY OF OPERATION

The ADP121 is a low quiescent current, low dropout linear regulator that operates from 2.3 V to 5.5 V and provides up to 150 mA of output current. Drawing a low 30 μA quiescent current (typical) at full load makes the ADP121 ideal for battery-operated portable equipment. Shutdown current consumption is typically 100 nA.

Optimized for use with small 1 μF ceramic capacitors, the ADP121 provides excellent transient performance.

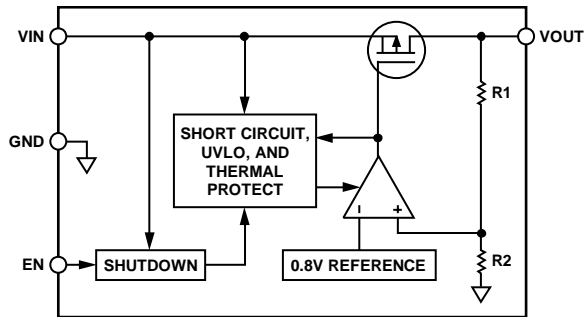

Figure 27. Internal Block Diagram

Internally, the ADP121 consists of a reference, an error amplifier, a feedback voltage divider, and a PMOS pass transistor. Output current is delivered via the PMOS pass device, which is controlled by the error amplifier. The error amplifier compares the reference voltage with the feedback voltage from the output and amplifies the difference. If the feedback voltage is lower than the reference voltage, the gate of the PMOS device is pulled lower, allowing more current to flow and increasing the output voltage. If the feedback voltage is higher than the reference voltage, the gate of the PMOS device is pulled higher, allowing less current to flow and decreasing the output voltage.

The ADP121 is available in output voltages ranging from 1.2 V to 3.3 V. The ADP121 uses the EN pin to enable and disable the VOUT pin under normal operating conditions. When EN is high, VOUT turns on; when EN is low, VOUT turns off. For automatic startup, EN can be tied to VIN.

APPLICATIONS INFORMATION

CAPACITOR SELECTION

Output Capacitor

The ADP121 is designed for operation with small, space-saving ceramic capacitors, but functions with most commonly used capacitors as long as care is taken with the effective series resistance (ESR) value. The ESR of the output capacitor affects stability of the LDO control loop. A minimum of 0.70 μF capacitance with an ESR of 1 Ω or less is recommended to ensure stability of the ADP121. The transient response to changes in the load current is also affected by output capacitance. Using a larger value of output capacitance improves the transient response of the ADP121 to large changes in the load current. Figure 28 and Figure 29 show the transient responses for output capacitance values of 1 μF and 4.7 μF , respectively.

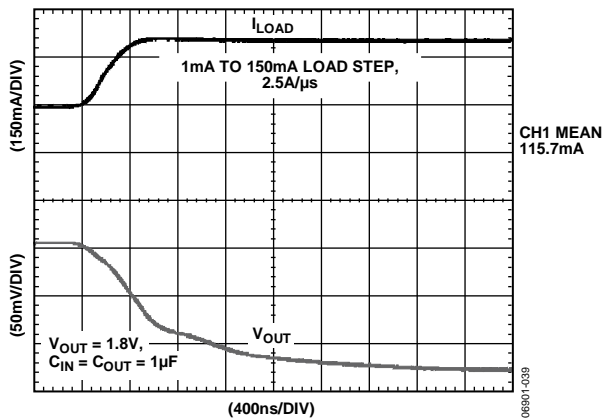

Figure 28. Output Transient Response, $C_{OUT} = 1 \mu\text{F}$

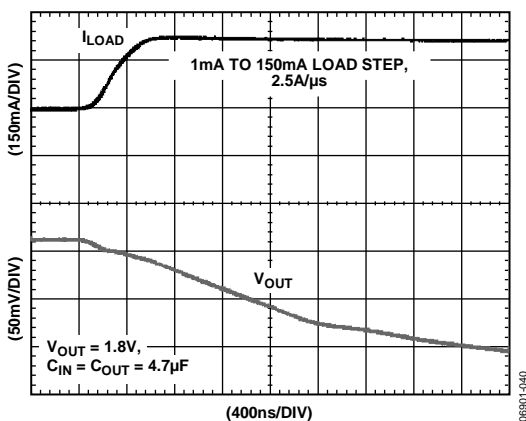

Figure 29. Output Transient Response, $C_{OUT} = 4.7 \mu\text{F}$

Input Bypass Capacitor

Connecting a 1 μF capacitor from VIN to GND reduces the circuit sensitivity to the PCB layout, especially when long input traces or high source impedance is encountered. If output capacitance greater than 1 μF is required, the input capacitor should be increased to match it.

Input and Output Capacitor Properties

Any good quality ceramic capacitor can be used with the ADP121, as long as it meets the minimum capacitance and maximum ESR requirements. Ceramic capacitors are manufactured with a variety of dielectrics, each with a different behavior over temperature and applied voltage. Capacitors must have an adequate dielectric to ensure the minimum capacitance over the necessary temperature range and dc bias conditions. X5R or X7R dielectrics with a voltage rating of 6.3 V or 10 V are recommended. Y5V and Z5U dielectrics are not recommended, due to their poor temperature and dc bias characteristics.

Figure 30 depicts the capacitance vs. voltage bias characteristic of an 0402 1 μF , 10 V, X5R capacitor. The voltage stability of a capacitor is strongly influenced by the capacitor size and voltage rating. In general, a capacitor in a larger package or higher voltage rating exhibits better stability. The temperature variation of the X5R dielectric is about $\pm 15\%$ over the -40°C to $+85^\circ\text{C}$ temperature range and is not a function of package or voltage rating.

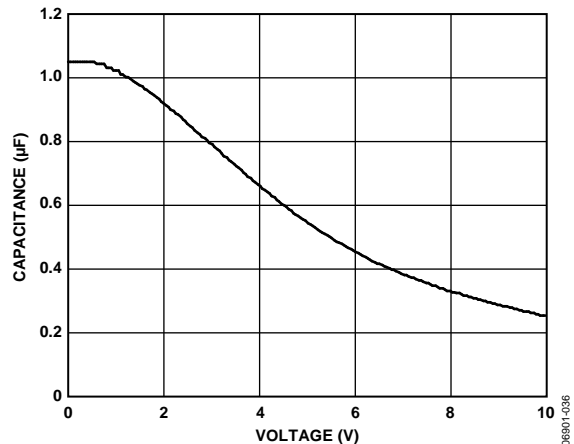

Figure 30. Capacitance vs. Voltage Bias Characteristic

Equation 1 can be used to determine the worst-case capacitance accounting for capacitor variation over temperature, component tolerance, and voltage.

$$C_{EFF} = C_{BIAS} \times (1 - TEMPCO) \times (1 - TOL) \quad (1)$$

where:

C_{BIAS} is the effective capacitance at the operating voltage.
 $TEMPCO$ is the worst-case capacitor temperature coefficient.
 TOL is the worst-case component tolerance.

In this example, $TEMPCO$ over -40°C to $+85^{\circ}\text{C}$ is assumed to be 15% for an X5R dielectric. TOL is assumed to be 10%, and C_{BIAS} is $0.94 \mu\text{F}$ at 1.8 V from the graph in Figure 30.

Substituting these values in Equation 1 yields

$$C_{EFF} = 0.94 \mu\text{F} \times (1 - 0.15) \times (1 - 0.1) = 0.719 \mu\text{F}$$

Therefore, the capacitor chosen in this example meets the minimum capacitance requirement of the LDO over temperature and tolerance at the chosen output voltage.

To guarantee the performance of the ADP121, it is imperative that the effects of dc bias, temperature, and tolerances on the behavior of the capacitors are evaluated for each application.

UNDERVOLTAGE LOCKOUT

The ADP121 has an internal undervoltage lockout circuit that disables all inputs and the output when the input voltage is less than approximately 2.2 V. This ensures that the inputs of the ADP121 and the output behave in a predictable manner during power-up.

ENABLE FEATURE

The ADP121 uses the EN pin to enable and disable the VOUT pin under normal operating conditions. Figure 31 shows a rising voltage on EN crossing the active threshold, and then VOUT turns on. When a falling voltage on EN crosses the inactive threshold, VOUT turns off.

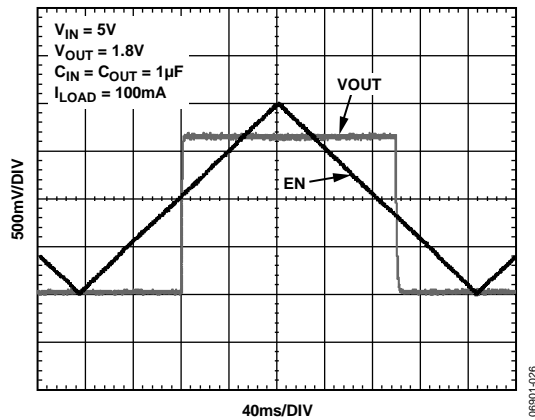

Figure 31. ADP121 Typical EN Pin Operation

As shown in Figure 31, the EN pin has built in hysteresis. This prevents on/off oscillations that may occur due to noise on the EN pin as it passes through the threshold points.

The active/inactive thresholds of the EN pin are derived from the VIN voltage. Therefore, these thresholds vary with changing input voltage. Figure 32 shows typical EN active/inactive thresholds when the input voltage varies from 2.3 V to 5.5 V.

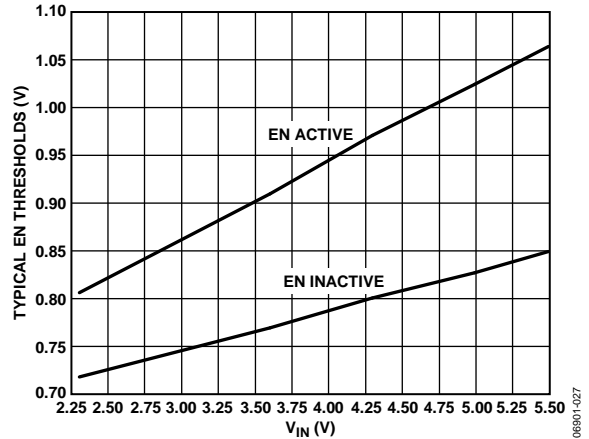

Figure 32. Typical EN Pin Thresholds vs. Input Voltage

The ADP121 utilizes an internal soft start to limit the inrush current when the output is enabled. The start-up time for the 1.8 V option is approximately 120 μs from the time the EN active threshold is crossed to when the output reaches 90% of its final value. The start-up time is somewhat dependant on the output voltage setting and increases slightly as the output voltage increases.

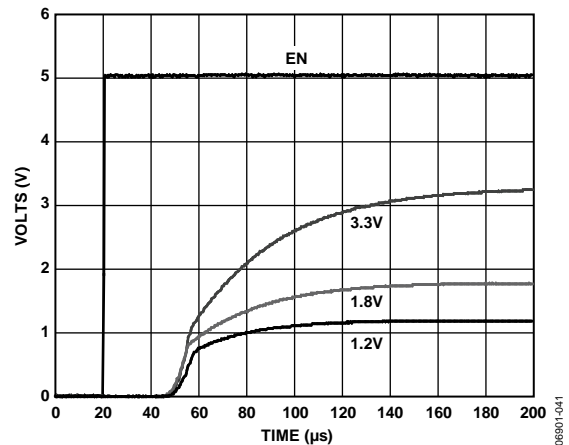

Figure 33. Typical Start-Up Time

CURRENT LIMIT AND THERMAL OVERLOAD PROTECTION

The ADP121 is protected against damage due to excessive power dissipation by current and thermal overload protection circuits. The ADP121 is designed to current limit when the output load reaches 225 mA (typical). When the output load exceeds 225 mA, the output voltage is reduced to maintain a constant current limit.

Thermal overload protection is built-in, which limits the junction temperature to a maximum of 150°C (typical). Under extreme conditions (that is, high ambient temperature and power dissipation) when the junction temperature starts to rise above 150°C, the output is turned off, reducing the output current to zero. When the junction temperature drops below 135°C, the output is turned on again and output current is restored to its nominal value.

Consider the case where a hard short from VOUT to GND occurs. At first, the ADP121 current limits, so that only 225 mA is conducted into the short. If self-heating of the junction is great enough to cause its temperature to rise above 150°C, thermal shutdown activates turning off the output and reducing the output current to zero. As the junction temperature cools and drops below 135°C, the output turns on and conducts 225 mA into the short, again causing the junction temperature to rise above 150°C. This thermal oscillation between 135°C and 150°C causes a current oscillation between 225 mA and 0 mA that continues as long as the short remains at the output.

Current and thermal limit protections are intended to protect the device against accidental overload conditions. For reliable operation, device power dissipation must be externally limited so junction temperatures do not exceed 125°C.

THERMAL CONSIDERATIONS

In most applications, the ADP121 does not dissipate a lot of heat due to high efficiency. However, in applications with a high ambient temperature and high supply voltage to an output voltage differential, the heat dissipated in the package is large enough that it can cause the junction temperature of the die to exceed the maximum junction temperature of 125°C.

When the junction temperature exceeds 150°C, the converter enters thermal shutdown. It recovers only after the junction temperature has decreased below 135°C to prevent any permanent damage. Therefore, thermal analysis for the chosen application is very important to guarantee reliable performance over all conditions. The junction temperature of the die is the sum of the ambient temperature of the environment and the temperature rise of the package due to the power dissipation, as shown in Equation 2.

To guarantee reliable operation, the junction temperature of the ADP121 must not exceed 125°C. To ensure that the junction temperature stays below this maximum value, the user needs to be aware of the parameters that contribute to junction temperature changes. These parameters include ambient temperature, power

dissipation in the power device, and thermal resistances between the junction-and-ambient air (θ_{JA}). The θ_{JA} number is dependent on the package assembly compounds used and the amount of copper to which the GND pins of the package are soldered on the PCB. Table 6 shows typical θ_{JA} values for various PCB copper sizes and Table 7 shows the typical Ψ_{JB} values for the ADP121.

Table 6. Typical θ_{JA} Values

Copper Size (mm ²)	TSOT (°C/W)	WLCSP (°C/W)
0 ¹	170	260
50	152	159
100	146	157
300	134	153
500	131	151

¹ Device soldered to minimum size pin traces.

Table 7. Typical Ψ_{JB} Values

TSOT (°C/W)	WLCSP (°C/W)
42.8	58.4

The junction temperature of the ADP121 can be calculated from the following equation:

$$T_J = T_A + (P_D \times \theta_{JA}) \quad (2)$$

where:

T_A is the ambient temperature.

P_D is the power dissipation in the die, given by

$$P_D = [(V_{IN} - V_{OUT}) \times I_{LOAD}] + (V_{IN} \times I_{GND}) \quad (3)$$

where:

I_{LOAD} is the load current.

I_{GND} is the ground current.

V_{IN} and V_{OUT} are input and output voltages, respectively.

Power dissipation due to ground current is quite small and can be ignored. Therefore, the junction temperature equation simplifies to

$$T_J = T_A + \{[(V_{IN} - V_{OUT}) \times I_{LOAD}] \times \theta_{JA}\} \quad (4)$$

As shown in Equation 4, for a given ambient temperature, input-to-output voltage differential, and continuous load current, there exists a minimum copper size requirement for the PCB to ensure that the junction temperature does not rise above 125°C. Figure 34 to Figure 47 show junction temperature calculations for different ambient temperatures, load currents, V_{IN} -to- V_{OUT} differentials, and areas of PCB copper.

In cases where the board temperature is known, the thermal characterization parameter, Ψ_{JB} , can be used to estimate the junction temperature rise. T_J is calculated from T_B and P_D using the formula

$$T_J = T_B + (P_D \times \Psi_{JB}) \quad (5)$$

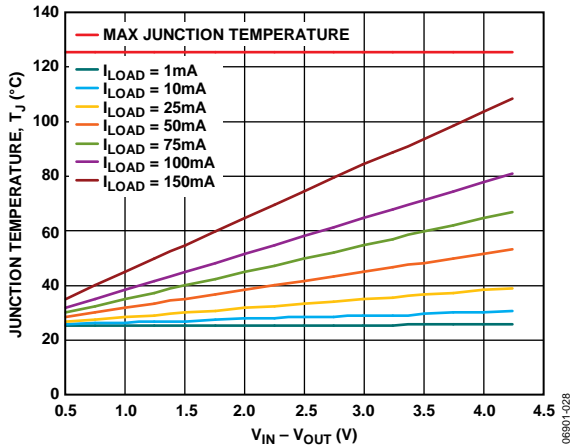

Figure 34. TSOT, 500 mm² of PCB Copper, T_A = 25°C

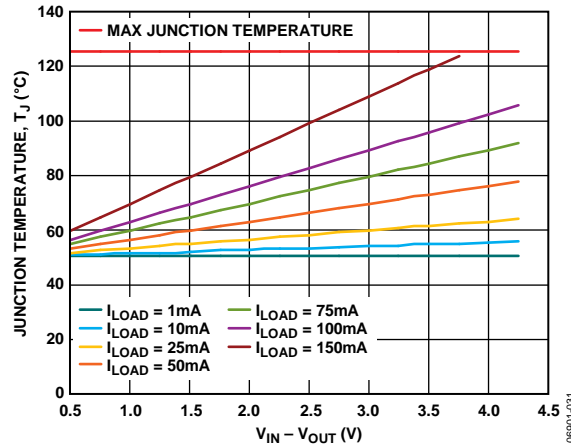

Figure 37. TSOT, 500 mm² of PCB Copper, T_A = 50°C

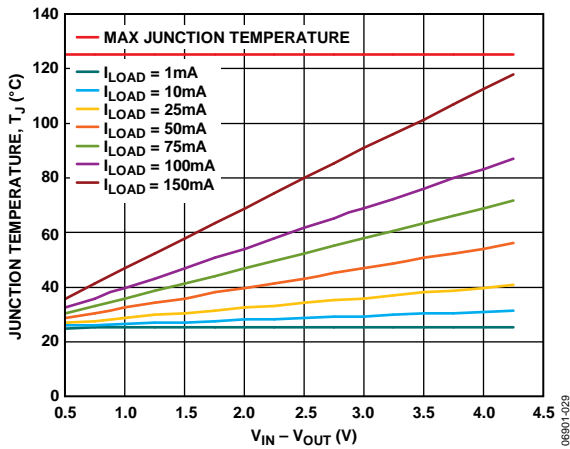

Figure 35. TSOT, 100 mm² of PCB Copper, T_A = 25°C

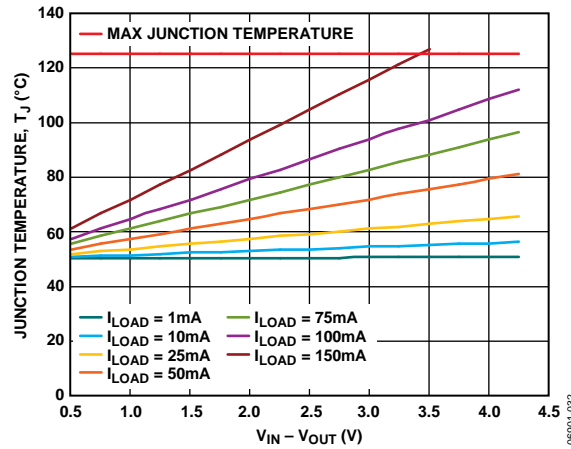

Figure 38. TSOT, 100 mm² of PCB Copper, T_A = 50°C

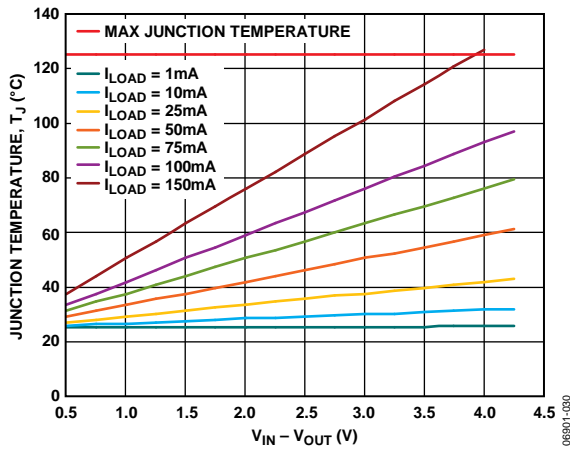

Figure 36. TSOT, 0 mm² of PCB Copper, T_A = 25°C

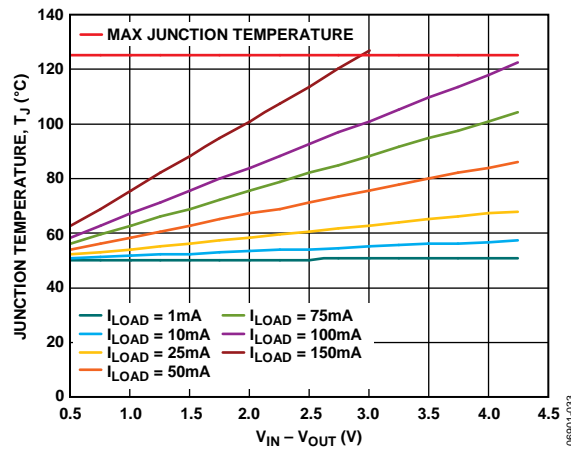

Figure 39. TSOT, 0 mm² of PCB Copper, T_A = 50°C

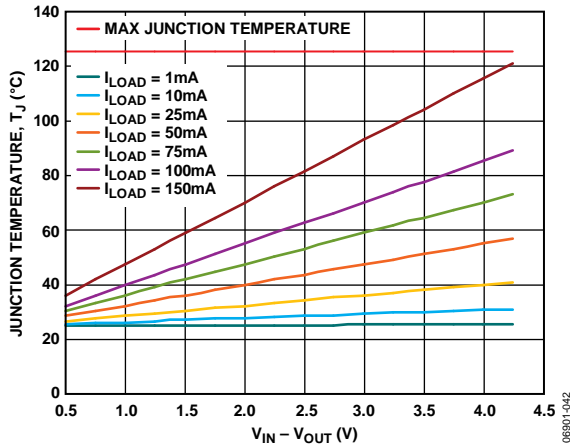

Figure 40. WLCSP, 500 mm² of PCB Copper, T_A = 25°C

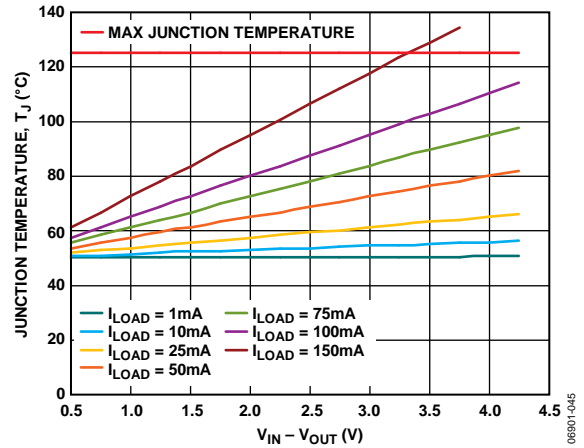

Figure 43. WLCSP, 500 mm² of PCB Copper, T_A = 50°C

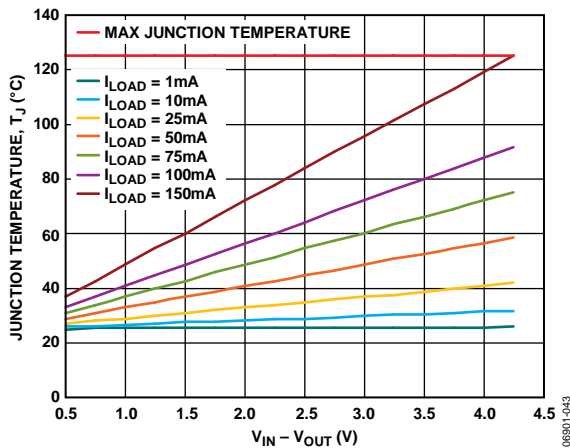

Figure 41. WLCSP, 100 mm² of PCB Copper, T_A = 25°C

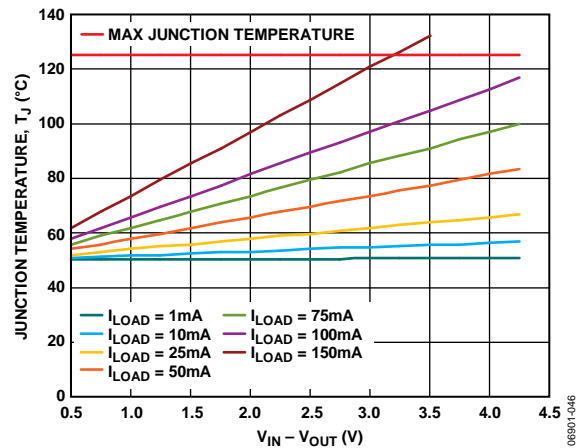

Figure 44. WLCSP, 100 mm² of PCB Copper, T_A = 50°C

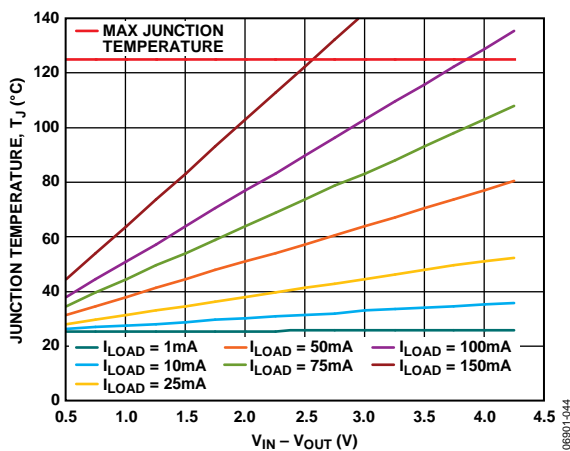

Figure 42. WLCSP, 0 mm² of PCB Copper, T_A = 25°C

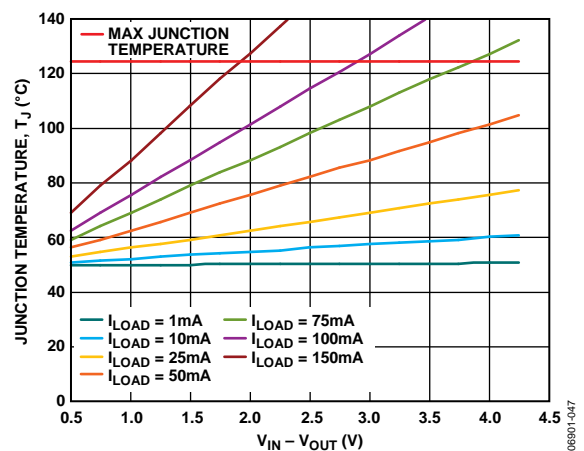

Figure 45. WLCSP, 0 mm² of PCB Copper, T_A = 50°C

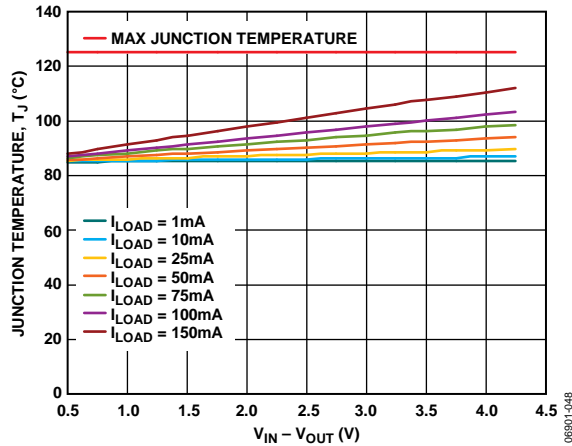

Figure 46. TSOT, 100 mm² of PCB Copper, Board Temperature = 85°C

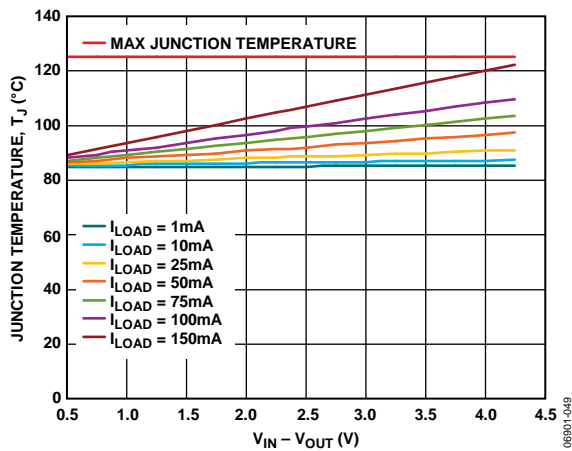

Figure 47. WLCSP, 100 mm² of PCB Copper, Board Temperature = 85°C

PCB LAYOUT CONSIDERATIONS

Heat dissipation from the package can be improved by increasing the amount of copper attached to the pins of the ADP121. However, as can be seen from Table 6 and Table 7, a point of diminishing returns is eventually reached, beyond which an increase in the copper size does not yield significant heat dissipation benefits.

Place the input capacitor as close as possible to the VIN and GND pins. Place the output capacitor as close as possible to the VOUT and GND pins. Use 0402 or 0603 size capacitors and resistors to achieve the smallest possible footprint solution on boards where area is limited.

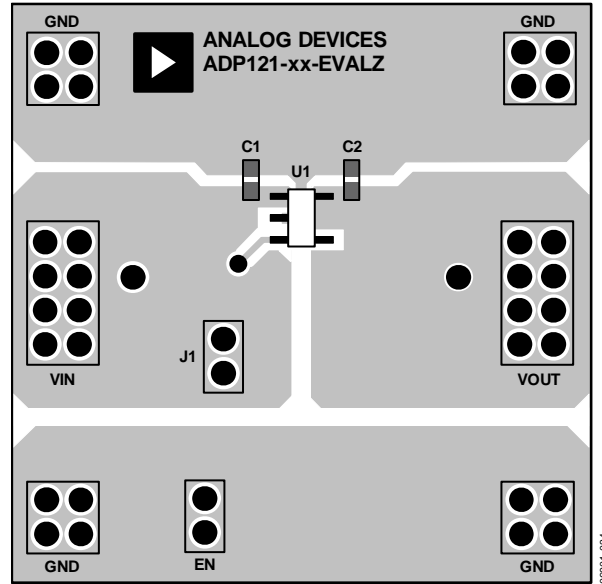

Figure 48. Example of TSOT PCB Layout

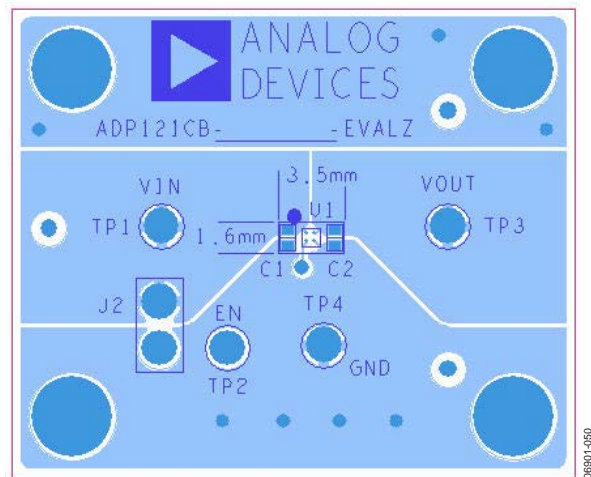

Figure 49. Example of WLCSP PCB Layout—Top Side

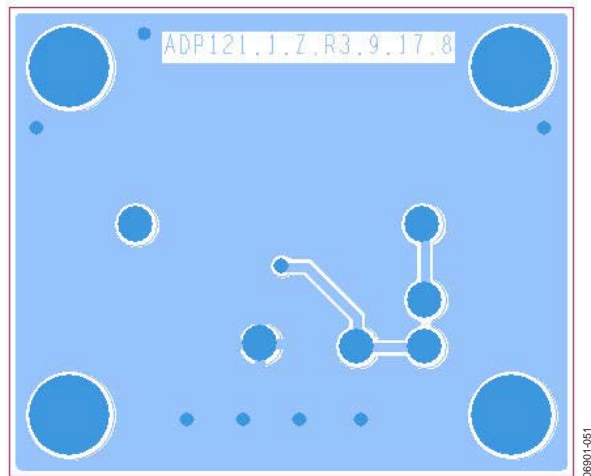
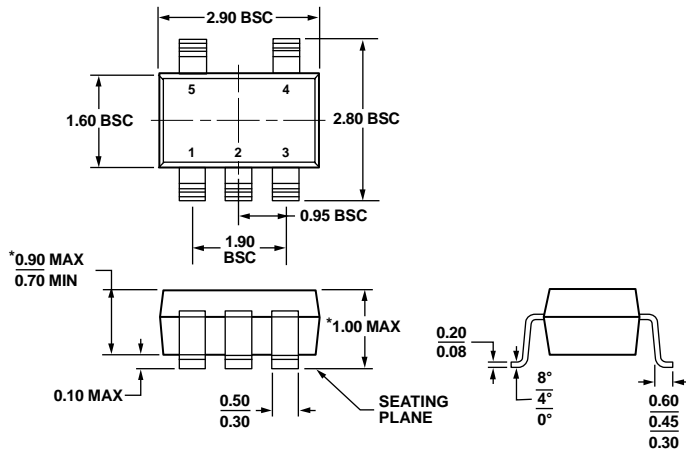

Figure 50. Example of WLCSP PCB Layout—Bottom Side

OUTLINE DIMENSIONS



*COMPLIANT TO JEDEC STANDARDS MO-193-AB WITH THE EXCEPTION OF PACKAGE HEIGHT AND THICKNESS.
 Figure 51. 5-Lead Thin Small Outline Transistor Package [TSOT] (UJ-5)
 Dimensions show in millimeters

100706-A

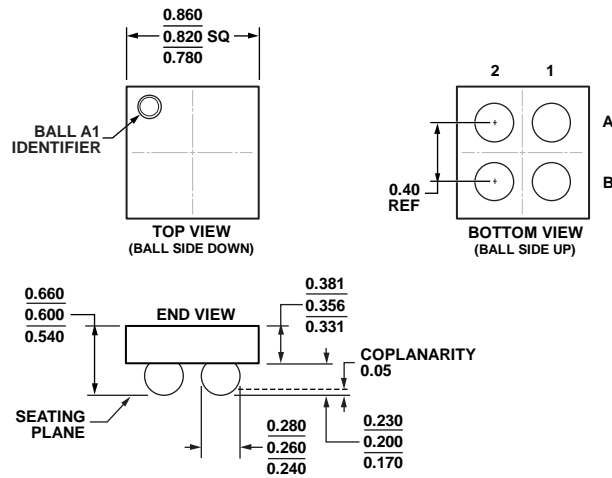

Figure 52. 4-Ball Wafer Level Chip Scale- Package [WLCSP] (CB-4-2)
 Dimensions show in millimeters

07-10-2012-A

ORDERING GUIDE

Model ¹	Temperature Range	Output Voltage (V) ²	Package Description	Package Option ³	Branding
ADP121-AUJZ12R7	-40°C to +125°C	1.2	5-Lead TSOT	UJ-5	LC0
ADP121-AUJZ15R7	-40°C to +125°C	1.5	5-Lead TSOT	UJ-5	LC1
ADP121-AUJZ18R7	-40°C to +125°C	1.8	5-Lead TSOT	UJ-5	LC7
ADP121-AUJZ20R7	-40°C to +125°C	2.0	5-Lead TSOT	UJ-5	LC9
ADP121-AUJZ25R7	-40°C to +125°C	2.5	5-Lead TSOT	UJ-5	LCA
ADP121-AUJZ28R7	-40°C to +125°C	2.8	5-Lead TSOT	UJ-5	LA3
ADP121-AUJZ30R7	-40°C to +125°C	3.0	5-Lead TSOT	UJ-5	LA4
ADP121-AUJZ33R7	-40°C to +125°C	3.3	5-Lead TSOT	UJ-5	LA5
ADP121-ACBZ12R7	-40°C to +125°C	1.2	4-Ball WLCSP	CB-4-2	LC0
ADP121-ACBZ15R7	-40°C to +125°C	1.5	4-Ball WLCSP	CB-4-2	LC1
ADP121-ACBZ165R7	-40°C to +125°C	1.65	4-Ball WLCSP	CB-4-2	LC4
ADP121-ACBZ18R7	-40°C to +125°C	1.8	4-Ball WLCSP	CB-4-2	LC7
ADP121-ACBZ188R7	-40°C to +125°C	1.875	4-Ball WLCSP	CB-4-2	LC8
ADP121-ACBZ20R7	-40°C to +125°C	2.0	4-Ball WLCSP	CB-4-2	LC9
ADP121-ACBZ25R7	-40°C to +125°C	2.5	4-Ball WLCSP	CB-4-2	LCA
ADP121-ACBZ28R7	-40°C to +125°C	2.8	4-Ball WLCSP	CB-4-2	LCD
ADP121-ACBZ30R7	-40°C to +125°C	3.0	4-Ball WLCSP	CB-4-2	LCF
ADP121-ACBZ33R7	-40°C to +125°C	3.3	4-Ball WLCSP	CB-4-2	LCG
ADP121CB-1.2-EVALZ		1.2	ADP121 1.2 V Output Evaluation Board		
ADP121CB-1.5-EVALZ		1.5	ADP121 1.5 V Output Evaluation Board		
ADP121CB-1.8-EVALZ		1.8	ADP121-1 1.8 V Output Evaluation Board		
ADP121CB-2.0-EVALZ		2.0	ADP121-1 2.0 V Output Evaluation Board		
ADP121CB-2.5-EVALZ		2.5	ADP121-1 2.5 V Output Evaluation Board		
ADP121CB-2.8-EVALZ		2.8	ADP121-1 2.8 V Output Evaluation Board		
ADP121CB-3.0-EVALZ		3.0	ADP121-1 3.0 V Output Evaluation Board		
ADP121CB-3.3-EVALZ		3.3	ADP121-1 3.3 V Output Evaluation Board		
ADP121UJZ-REDYKIT			Evaluation Board Kit		

¹ Z = RoHS Compliant Part.² For additional voltage options, contact your local Analog Devices, Inc., sales or distribution representative.³ The WLCSP package option is halide free.

NOTES

Компания «Life Electronics» занимается поставками электронных компонентов импортного и отечественного производства от производителей и со складов крупных дистрибьюторов Европы, Америки и Азии.

С конца 2013 года компания активно расширяет линейку поставок компонентов по направлению коаксиальный кабель, кварцевые генераторы и конденсаторы (керамические, пленочные, электролитические), за счёт заключения дистрибьюторских договоров

Мы предлагаем:

- Конкуренеспособные цены и скидки постоянным клиентам.
- Специальные условия для постоянных клиентов.
- Подбор аналогов.
- Поставку компонентов в любых объемах, удовлетворяющих вашим потребностям.
- Приемлемые сроки поставки, возможна ускоренная поставка.
- Доставку товара в любую точку России и стран СНГ.
- Комплексную поставку.
- Работу по проектам и поставку образцов.
- Формирование склада под заказчика.
- Сертификаты соответствия на поставляемую продукцию (по желанию клиента).
- Тестирование поставляемой продукции.
- Поставку компонентов, требующих военную и космическую приемку.
- Входной контроль качества.
- Наличие сертификата ISO.

В составе нашей компании организован Конструкторский отдел, призванный помогать разработчикам, и инженерам.

Конструкторский отдел помогает осуществить:

- Регистрацию проекта у производителя компонентов.
- Техническую поддержку проекта.
- Защиту от снятия компонента с производства.
- Оценку стоимости проекта по компонентам.
- Изготовление тестовой платы монтаж и пусконаладочные работы.



Тел: +7 (812) 336 43 04 (многоканальный)

Email: org@lifeelectronics.ru