

PTFC261402FC

Thermally-Enhanced High Power RF LDMOS FET 140 W, 28 V, 2620 – 2690 MHz

Description

The PTFC261402FC is a 140-watt LDMOS FET intended for use in multi-standard cellular power amplifier applications in the 2620 to 2690 MHz frequency band. Features include input and output matching, high gain and thermally-enhanced package with earless flange. Manufactured with Wolfspeed's advanced LDMOS process, this device provides excellent thermal performance and superior reliability.



PTFC261402FC
Package H-37248-4

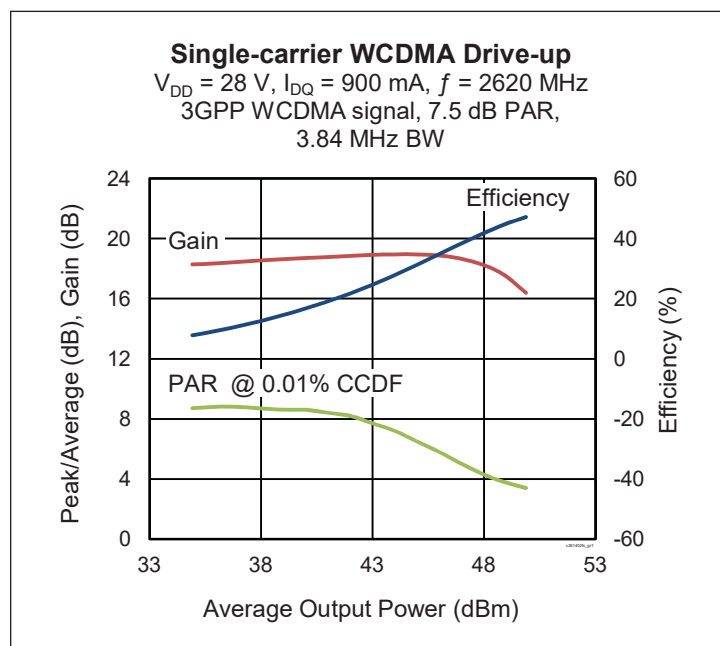

Features

- Broadband internal matching
- Wide video bandwidth
- Typical pulsed CW performance, 2655 MHz, 28 V (combined outputs)
 - Output power at $P_{1dB} = 140\text{ W}$
 - Efficiency = 50%
 - Gain = 16.5 dB
- Typical single-carrier WCDMA performance, 2655 MHz, 28 V
 - Output power = 46 dBm avg
 - Gain = 17.5 dB
 - Efficiency = 30.5%
- Capable of handling 10:1 VSWR @ 28 V, 140 W (CW) output power
- Integrated ESD protection
- Human Body Model Class 1C (per ANSI/ESDA/ JEDEC JS-001)
- Low thermal resistance
- Pb-free and RoHS compliant

RF Characteristics

Single-carrier WCDMA Specifications (combined outputs, tested in Wolfspeed production test fixture)
 $V_{DD} = 28\text{ V}$, $I_{DQ} = 900\text{ mA}$, $P_{OUT} = 28\text{ W avg}$, $f = 2655\text{ MHz}$, 3GPP signal, channel bandwidth = 3.84 MHz, peak/average = 10 dB @ 0.01% CCDF

Characteristic	Symbol	Min	Typ	Max	Unit
Gain	G_{ps}	17	18	—	dB
Drain Efficiency	η_D	23.5	25	—	%
Adjacent Channel Power Ratio	ACPR	—	-34	-31	dBc

All published data at $T_{CASE} = 25^\circ\text{C}$ unless otherwise indicated

ESD: Electrostatic discharge sensitive device—observe handling precautions!



DC Characteristics (each side)

Characteristic	Conditions	Symbol	Min	Typ	Max	Unit
Drain-Source Breakdown Voltage	$V_{GS} = 0\text{ V}, I_{DS} = 10\text{ mA}$	$V_{(BR)DSS}$	65	—	—	V
Drain Leakage Current	$V_{DS} = 28\text{ V}, V_{GS} = 0\text{ V}$	I_{DSS}	—	—	1	μA
	$V_{DS} = 63\text{ V}, V_{GS} = 0\text{ V}$	I_{DSS}	—	—	10	μA
Gate Leakage Current	$V_{GS} = 10\text{ V}, V_{DS} = 0\text{ V}$	I_{GSS}	—	—	1	μA
On-State Resistance	$V_{GS} = 10\text{ V}, V_{DS} = 0.1\text{ V}$	$R_{DS(on)}$	—	0.1	—	Ω
Operating Gate Voltage	$V_{DS} = 28\text{ V}, I_{DQ} = 900\text{ mA}$	V_{GS}	—	2.5	—	V

Maximum Ratings

Parameter	Symbol	Value	Unit
Drain-Source Voltage	V_{DSS}	65	V
Gate-Source Voltage	V_{GS}	-6 to +10	V
Operating Voltage	V_{DD}	0 to +32	V
Junction Temperature	T_J	225	$^{\circ}\text{C}$
Storage Temperature Range	T_{STG}	-65 to +150	$^{\circ}\text{C}$
Thermal Resistance ($T_{CASE} = 70^{\circ}\text{C}, 140\text{ W CW}$)	$R_{\theta JC}$	0.30	$^{\circ}\text{C/W}$

Ordering Information

Type and Version	Order Code	Package and Description	Shipping
PTFC261402FC V1 R0	PTFC261402FC-V1-R0	Thermally-enhanced earless flange, push-pull	Tape & Reel, 50 pcs
PTFC261402FC V1 R250	PTFC261402FC-V1-R250	Thermally-enhanced earless flange, push-pull	Tape & Reel, 250 pcs

Pinout Diagram

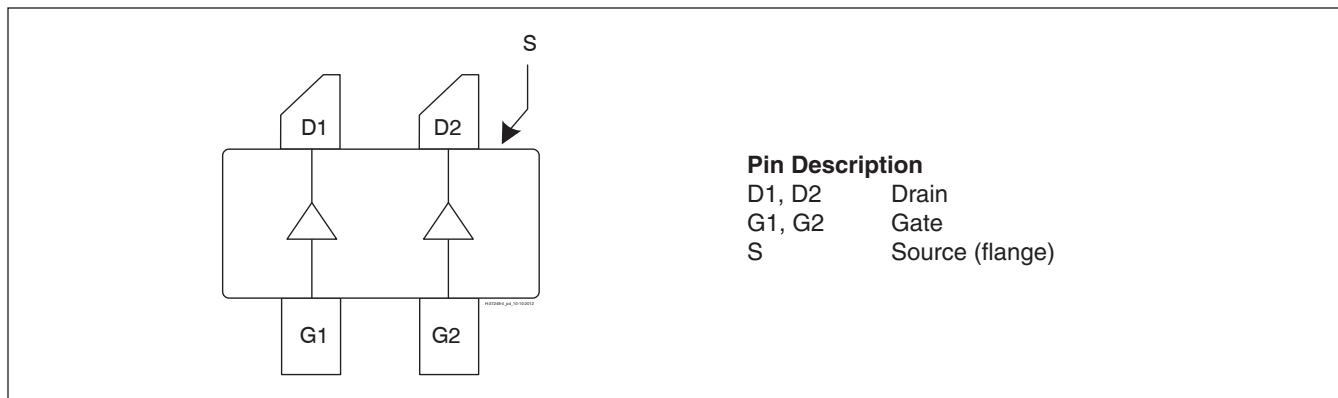

Lead connections for PTFC261402FC



Typical Performance (data taken in a production test fixture)

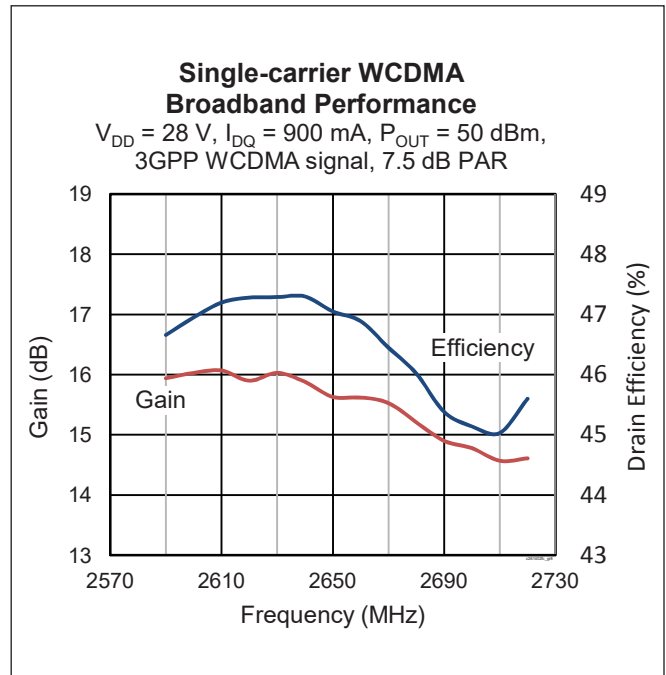
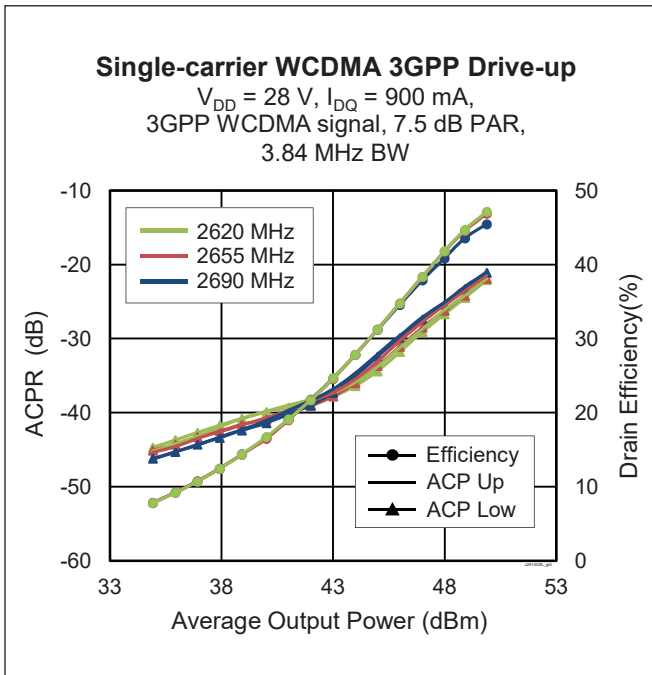
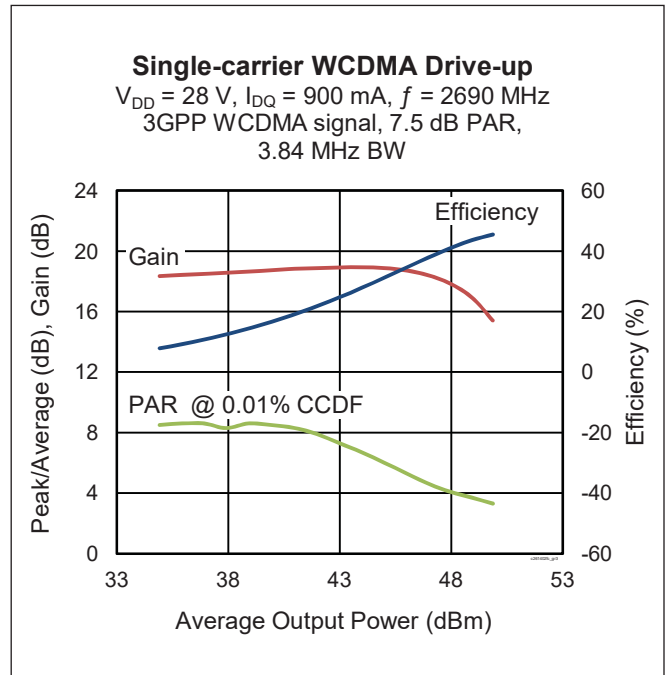
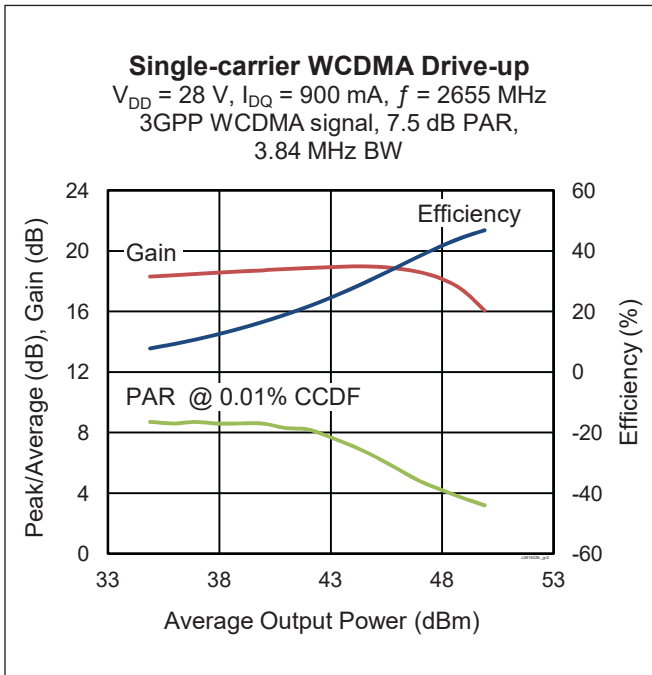



Typical Performance (cont.)

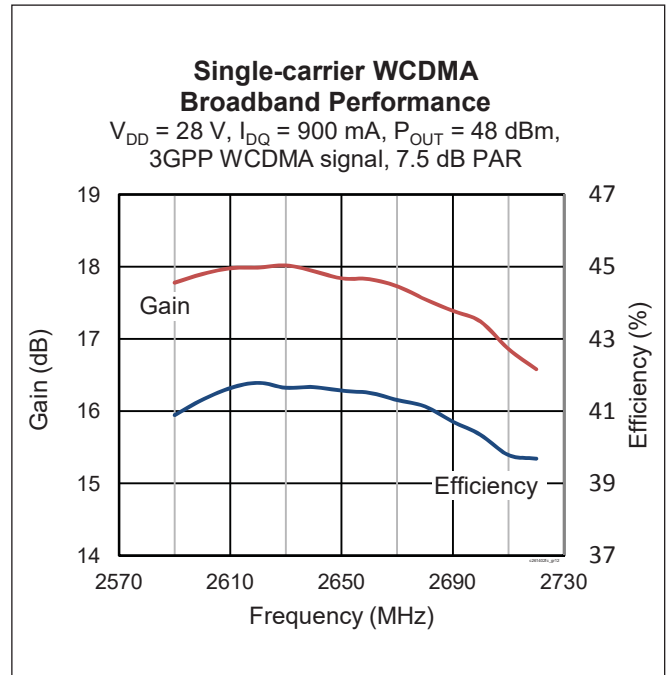
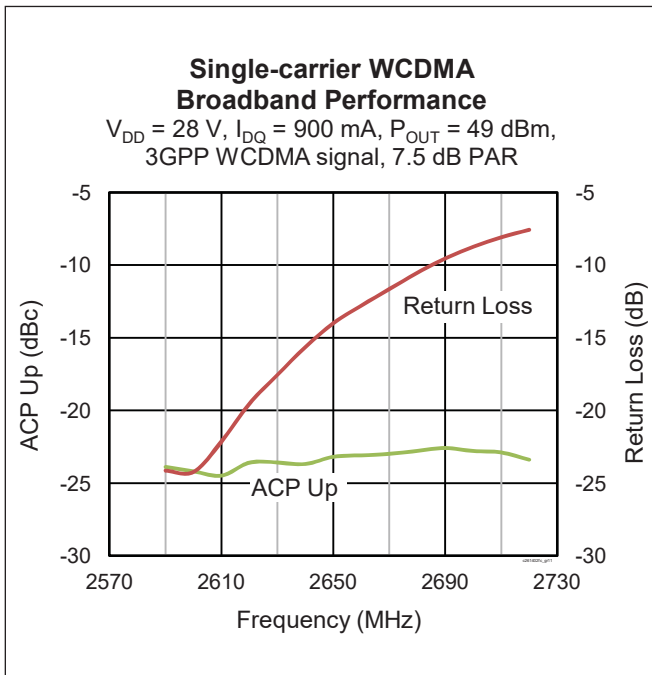
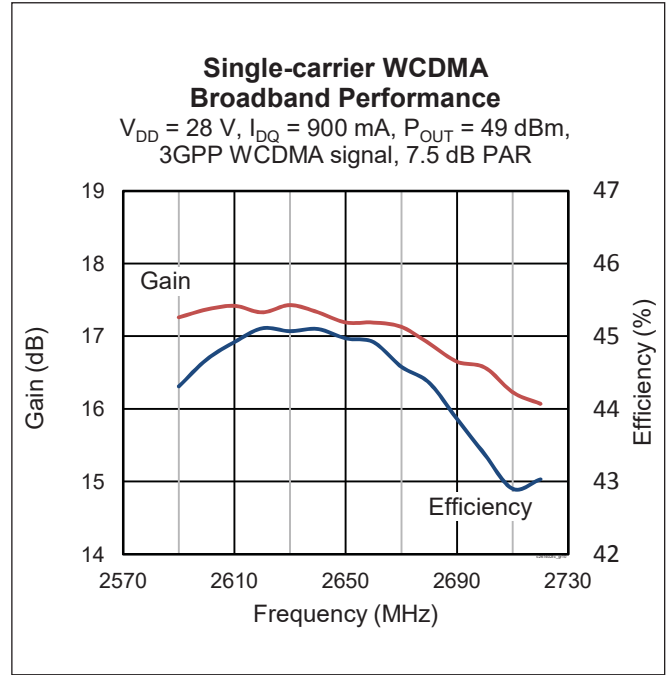
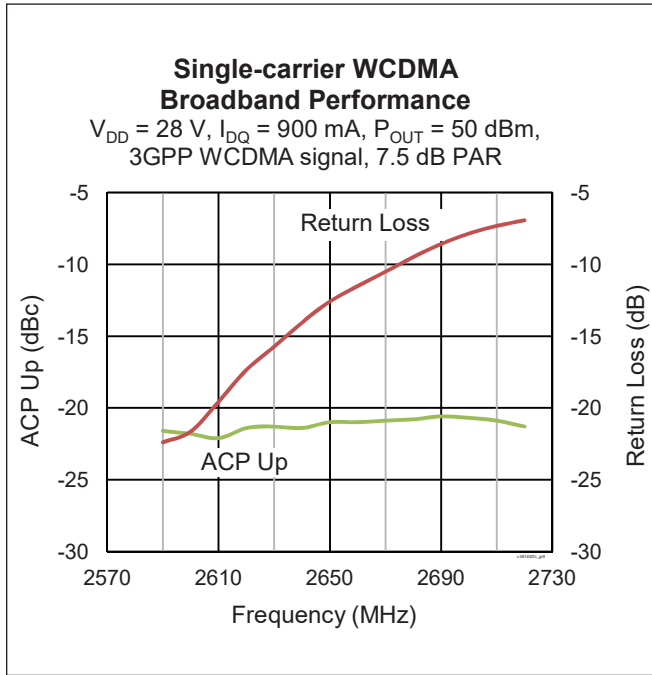

Typical Performance (cont.)

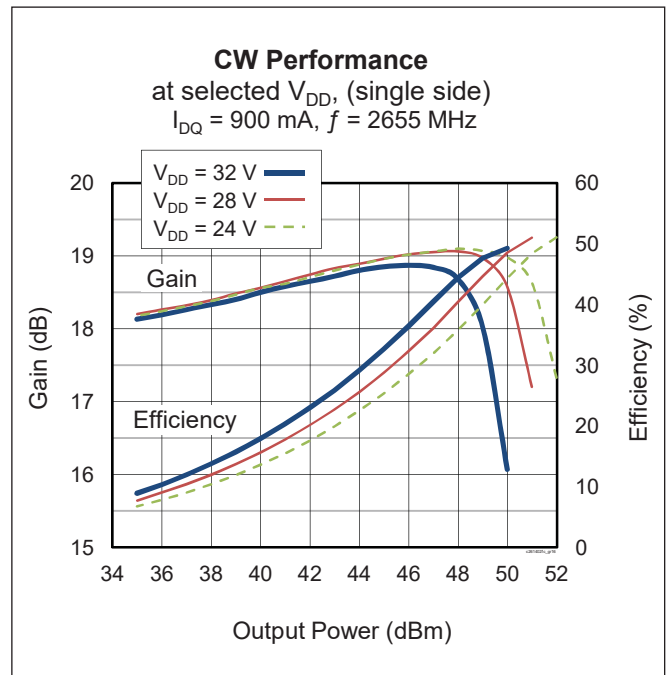
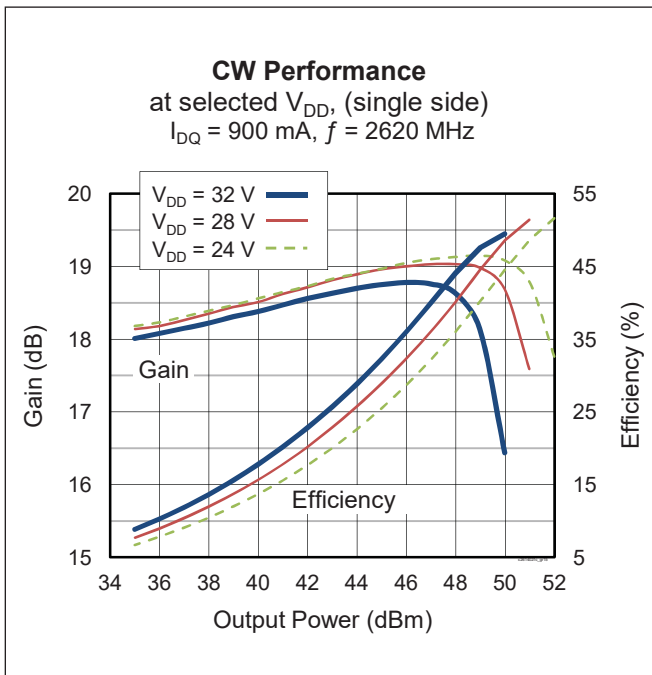
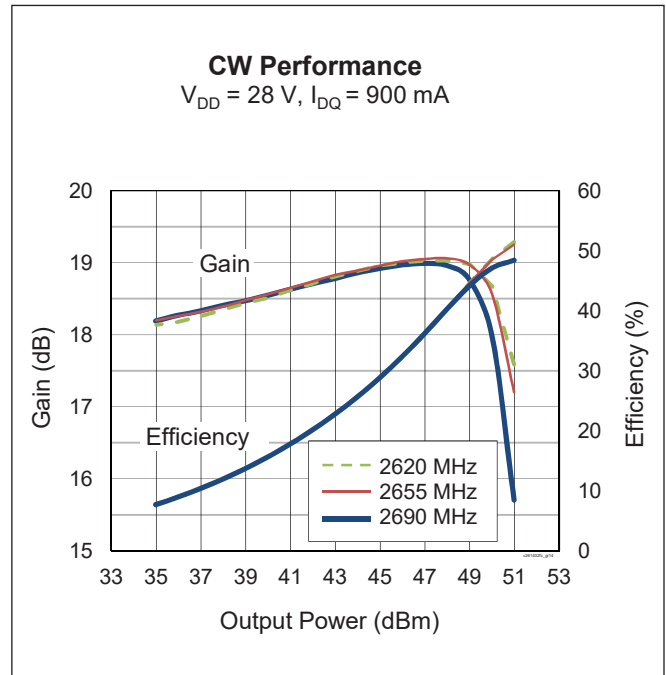
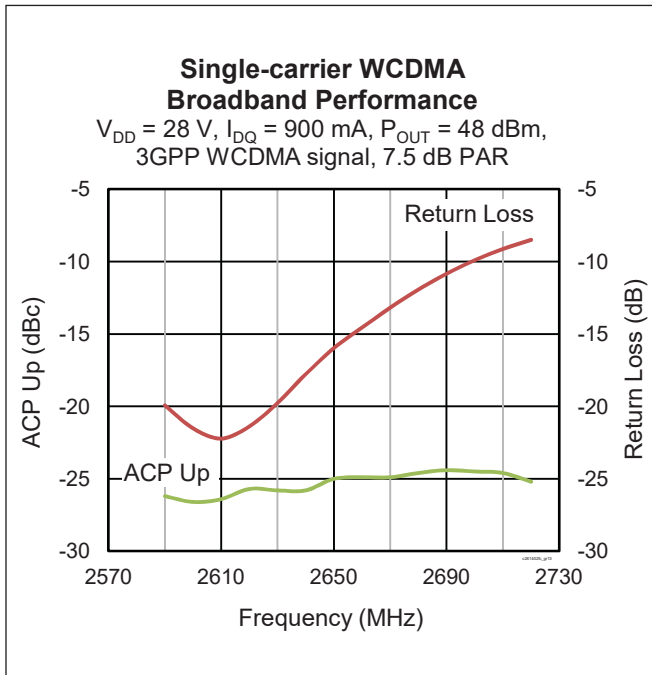



Typical Performance (cont.)

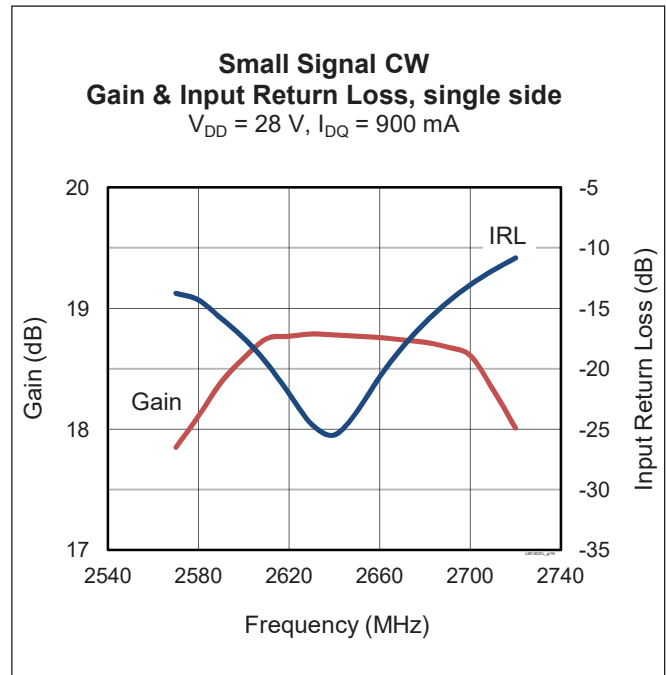
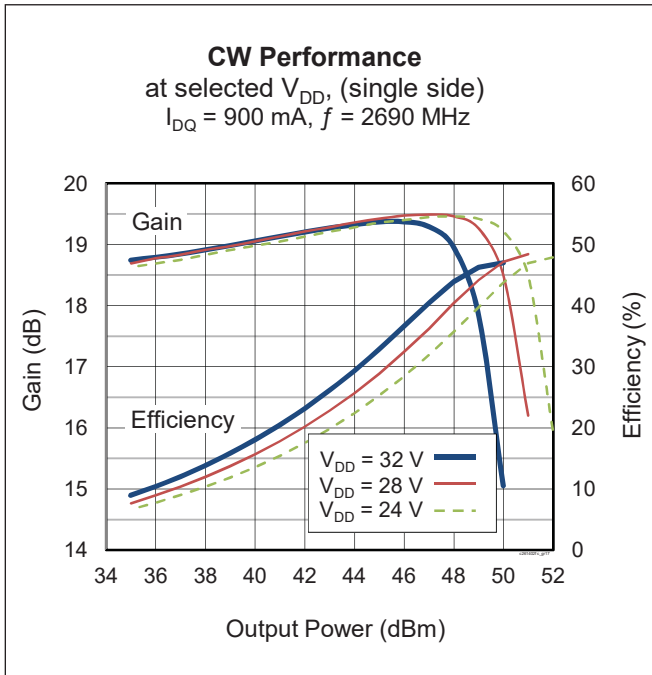

Load Pull Performance

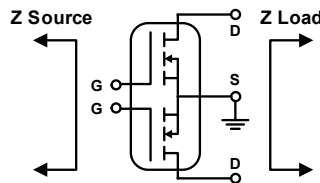

Single Side Load Pull Performance – Pulsed CW signal: 16 μsec , 10% duty cycle; 28 V, 450 mA

Class AB		P_{1dB}									
		Max Output Power					Max PAE				
Freq [MHz]	$Z_s \Omega$	$Z_l \Omega$	Gain [dB]	P_{OUT} [dBm]	P_{OUT} [W]	PAE %	$Z_l \Omega$	Gain [dB]	P_{OUT} [dBm]	P_{OUT} [W]	PAE %
2620	$12.1 - j1.0$	$2.0 - j8.8$	15.8	50.01	100	53.9	$3.8 - j7.4$	18	48.39	69	60.2
2655	$15.7 - j0.2$	$2.0 - j9.0$	15.7	49.98	99	53.2	$3.5 - j7.7$	17.9	48.50	71	59.5
2690	$17.8 - j12.4$	$2.0 - j9.2$	15.7	49.79	95	51.3	$3.6 - j7.8$	18.1	48.38	69	58.8

Reference Circuit

DUT	PTFC261402FC
Test Fixture Part No.	LTN/PTFC261402FC
PCB	Rogers 4350, 0.508 mm [.020"] thick, 2 oz. copper, $\epsilon_r = 3.66$
Find Gerber files for this test fixture on the Wolfspeed Web site at (www.wolfspeed.com/RF)	

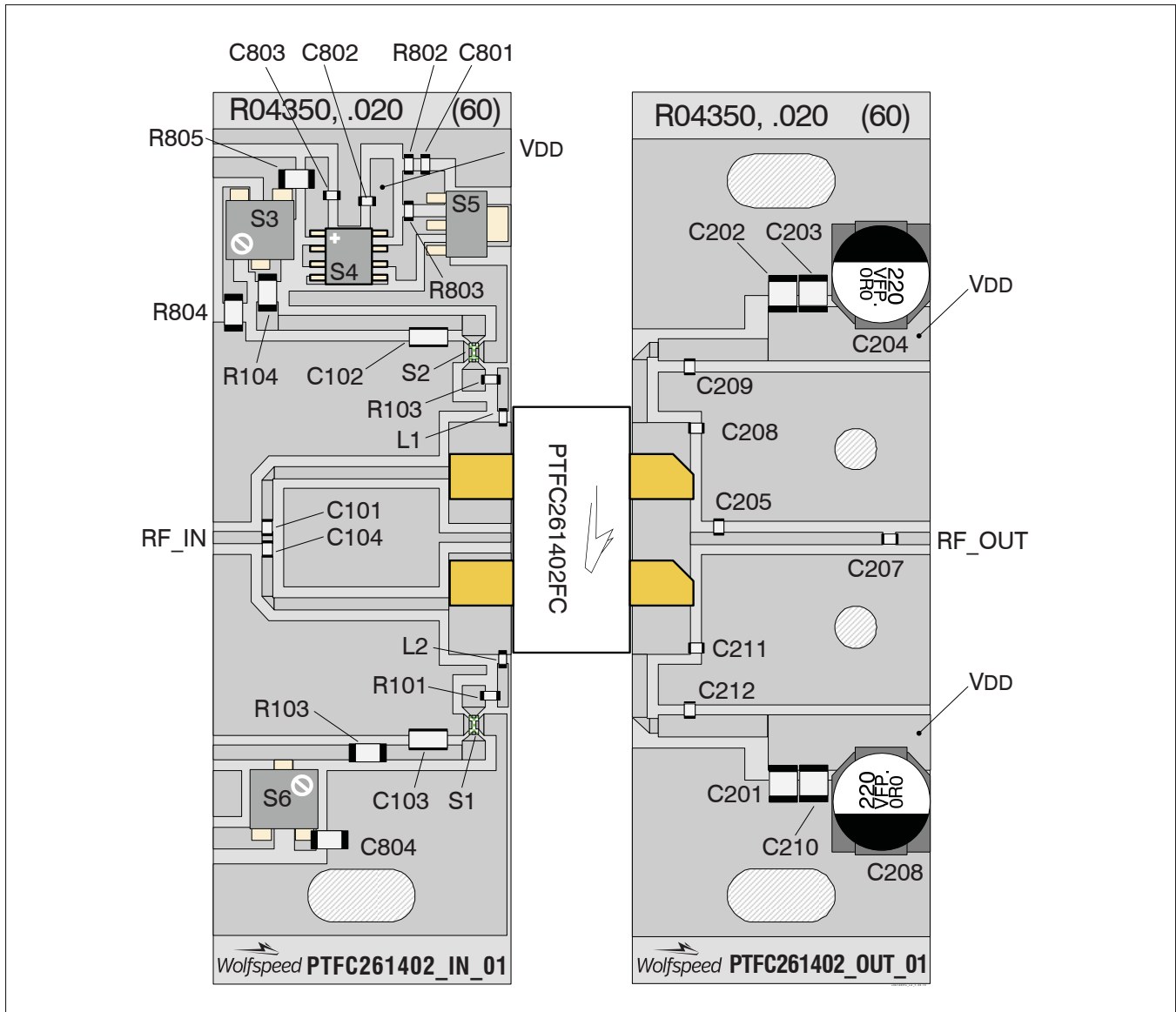

Reference circuit assembly diagram (not to scale)



Reference Circuit (cont.)

Components Information

Component	Description	Suggested Supplier	P/N
Input			
C101, C104	Chip capacitor, 10 pF	ATC	ATC800A100JT
C102, C103	Capacitor, 10 μ F	Murata Electronics North America	LLL31BC70G106MA01L
C801, C802, C803	Capacitor, 1 nF	Panasonic	ECJ-1VB1H102K
L1, L2	Chip inductor, 47 nH	Coilcraft	0603HP-47NXJLU
R101, R102	Resistor, 10 W	Panasonic Electronic Components	ERJ-3GEYJ100V
R103, R104	Resistor, 10 W	Panasonic Electronic Components	ERJ-8GEYJ100V
R801, R804	Resistor, 1k W	Panasonic Electronic Components	ERJ-8GEYJ102V
R802	Resistor, 1.3k W	Panasonic Electronic Components	ERJ-3GEYJ132V
R803	Resistor, 1.2k W	Panasonic Electronic Components	ERJ-3GEYJ122V
S1, S2	High frequency EMI filter, 1 μ F	Murata Electronics North America	NFM18PS105R0J3D
S3	Potentiometer, 2k Ω	Bourns Inc.	3224W-1-202E
S4	Voltage Regulator	National Semiconductor	LM7805
S5	Transistor	Infineon Technologies	BCP56
Output			
C201, C202, C203, C210	Capacitor, 10 μ F	Taiyo Yuden	UMK325C7106MM-T
C204, C208	Electrolytic capacitor, 220 μ F	Panasonic Electronic Components	EEE-FP1V221AP
C205, C206	Chip capacitor, 1 pF	ATC	ATC800A1R2BT
C206, C211	Chip capacitor, 2 pF	ATC	ATC800A1R6BT
C207	Chip capacitor, 8 pF	ATC	ATC800A8R2CT
C209, C212	Chip capacitor, 10 pF	ATC	ATC800A100JT

Package Outline Specifications

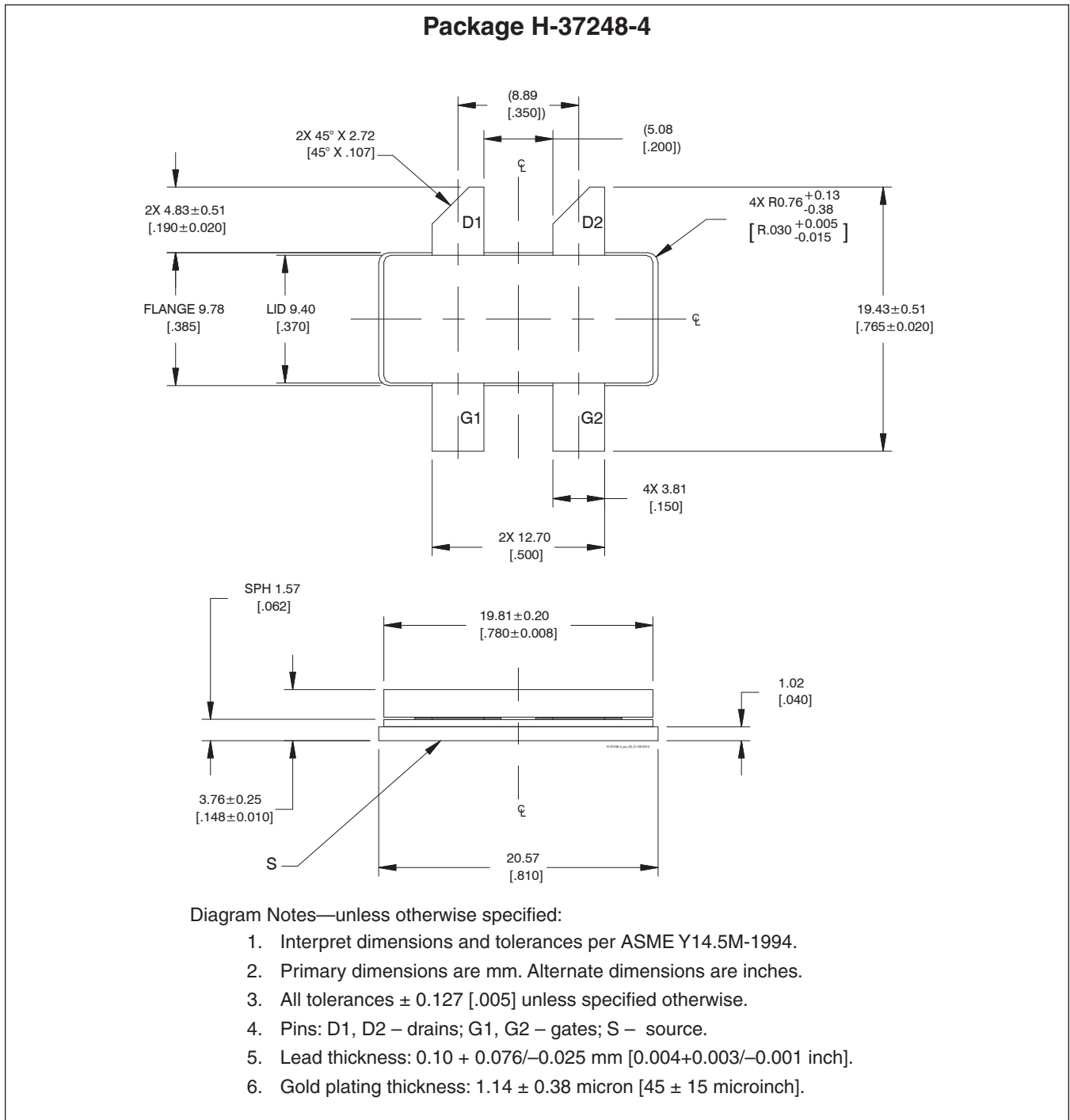

Revision History

Revision	Date	Data Sheet Type	Page	Subjects (major changes since last revision)
01	2011-11-10	Advance	All	Data Sheet reflects advance specification for product development.
02	2012-04-27	Preliminary	1, 2	Specifications updated.
03	2012-06-01	Advance	All	Reformat to Advance Specification—Marketing survey only.
04	2014-02-14	Production	All	Data Sheet reflects released product specification.
05	2016-06-21	Production	1 2	Added ESD rating Maximum junction temperature raised to 225 °C, updated ordering info.
06	2018-07-03	Production	All	Converted to Wolfspeed Data Sheet.

For more information, please contact:

4600 Silicon Drive
Durham, North Carolina, USA 27703
www.wolfspeed.com/RF

Sales Contact
RFSales@wolfspeed.com

RF Product Marketing Contact
RFMarketing@wolfspeed.com
919.407.7816

Notes

Disclaimer

Specifications are subject to change without notice. Cree, Inc. believes the information contained within this data sheet to be accurate and reliable. However, no responsibility is assumed by Cree for any infringement of patents or other rights of third parties which may result from its use. No license is granted by implication or otherwise under any patent or patent rights of Cree. Cree makes no warranty, representation or guarantee regarding the suitability of its products for any particular purpose. “Typical” parameters are the average values expected by Cree in large quantities and are provided for information purposes only. These values can and do vary in different applications and actual performance can vary over time. All operating parameters should be validated by customer’s technical experts for each application. Cree products are not designed, intended or authorized for use as components in applications intended for surgical implant into the body or to support or sustain life, in applications in which the failure of the Cree product could result in personal injury or death or in applications for planning, construction, maintenance or direct operation of a nuclear facility.

Компания «Life Electronics» занимается поставками электронных компонентов импортного и отечественного производства от производителей и со складов крупных дистрибьюторов Европы, Америки и Азии.

С конца 2013 года компания активно расширяет линейку поставок компонентов по направлению коаксиальный кабель, кварцевые генераторы и конденсаторы (керамические, пленочные, электролитические), за счёт заключения дистрибьюторских договоров

Мы предлагаем:

- Конкурентоспособные цены и скидки постоянным клиентам.
- Специальные условия для постоянных клиентов.
- Подбор аналогов.
- Поставку компонентов в любых объемах, удовлетворяющих вашим потребностям.
- Приемлемые сроки поставки, возможна ускоренная поставка.
- Доставку товара в любую точку России и стран СНГ.
- Комплексную поставку.
- Работу по проектам и поставку образцов.
- Формирование склада под заказчика.
- Сертификаты соответствия на поставляемую продукцию (по желанию клиента).
- Тестирование поставляемой продукции.
- Поставку компонентов, требующих военную и космическую приемку.
- Входной контроль качества.
- Наличие сертификата ISO.

В составе нашей компании организован Конструкторский отдел, призванный помогать разработчикам, и инженерам.

Конструкторский отдел помогает осуществить:

- Регистрацию проекта у производителя компонентов.
- Техническую поддержку проекта.
- Защиту от снятия компонента с производства.
- Оценку стоимости проекта по компонентам.
- Изготовление тестовой платы монтаж и пусконаладочные работы.



Тел: +7 (812) 336 43 04 (многоканальный)
Email: org@lifeelectronics.ru